

RIHO

Bathroom Living

K A T A L O G 2 0 2 3 / 2 0 2 4

KOUPELNOVÝ NÁBYTEK



Díky výraznému designu a inovativním výrobkům je RIHO více než čtyři desetiletí úspěšnou značkou.

V souladu s naší firemní filozofií "Vytváříme trvalé hodnoty" jsme našimi moderními výrobky zvýšili hodnotu sanitární kultury - jsme si ale také vědomi naší zodpovědnosti za budoucnost. Naše tvrzení o trvalých hodnotách má své místo i v oblasti životního prostředí.

Kvalita značky RIHO je patrná v každém detailu výrobku: v náročném designu, v dokonalém zpracování, na budoucnost orientované technologii, ve vysokém komfortu a vysoké spolehlivosti. Každá vana nebo sprchová vanička, každá masážní vana, sprchová zástěna či nábytek značky RIHO jsou dokonale přizpůsobeny lidem, kteří je

používají. Na výrobu umyvadel používáme pouze vysoce kvalitní materiály, jako jsou například litý mramor, SOLID SURFACE a keramika. Designové středisko firmy RIHO zajišťuje kontinuální vývoj nového koupelnového nábytku prodávaného pod značkou RIHO.

RIHO je reprezentováno výrobními závody nebo obchodním zastoupením v Holandsku, v České republice, Belgii, Německu, Francii, Maďarsku, Rumunsku a Polsku.

Naše společnost vyrábí široký sortiment koupelnového vybavení, jako jsou například vany, vaničky, masážní systémy, sprchové zástěny a koupelnový nábytek.



KATALOG 2023

OBSAH

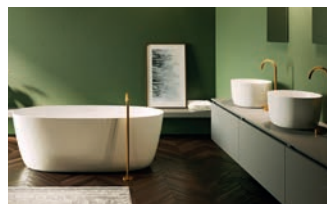

SOLID SURFACE 4 – 30



THERMAE LINE – SPECIÁLNÍ MASÁŽNÍ VANY 32 – 49

Informace 35



VANY, MASÁŽNÍ SYSTÉMY 50 – 155

Popis masážních systémů 66 – 76

Podhlavníky, Odtokové a přepadové soupravy, příslušenství, Panely 61 – 65

Volně stojící akrylátové vany 82 – 97

Vany Plug&Play 98 – 111

Akrylátové vany 112 – 155

Technické výkresy 156 – 173



SPRCHOVÉ VANIČKY 176 – 191

Isola 178 – 179

Velvet Sole, Basel 180 – 185

Zürich, Davos, Kolping 186 – 191



SPRCHOVÉ ZÁSTĚNY 192 – 259

VANOVÉ ZÁSTĚNY 246 – 253

Přehled typů 194 – 196

Všeobecné informace 197

Zástěny s potiskem a v provedení Satinato 254 – 255

Atypické provedení 256 – 257



PŘÍSLUŠENSTVÍ 260 – 261

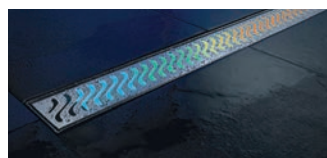

PODLAHOVÉ ŽLABY 262 – 277



NÁBYTEK 278 – 430

Spring Série 280 – 313

Livit Série 314 – 403

FromScratch Série 404 – 415

Příslušenství (Zrcadla, zrcadlové skříňky, doplňky) 416 – 430

SOLID SURFACE

THERMAE LINE

VANY, MASÁŽNÍ SYSTÉMY

SPRCHOVÉ VANIČKY

SPRCHOVÉ A VANOVÉ ZÁSTĚNY

PŘÍSLUŠENSTVÍ

PODLAHOVÉ ŽLABY

NÁBYTEK

NÁBYTEK

UNIKÁTNÍ DESIGN PRO VAŠI KOUPELNU



KOUPELNOVÝ NÁBYTEK

RIHO je místo, kde získáte kompletní zařízení vaší koupelny .

Vytvořte si příjemnou atmosféru ve vaší koupelně pomocí krásných koupelnových skříněk. Tři kolekce nábytku v tomto katalogu mají svůj vlastní styl, od venkovského po moderní. Každý zákazník si tedy může skvěle zkombinovat každý interiér svého domu či bytu.

Kolekce nábytku RIHO jsou velmi dobře kombinovatelné se všemi dalšími produkty z našeho portfolia, vanami, sprchovými i vanovými zástěnami, se sprchovými vaničkami.



SPRING: SVĚŽÍ A TRENDOVÉ BARVY

SPRING (jaro) je kolekce, která, stejně jako jaro je o inovaci. Nábytek této řady je plně funkční, svěžího a trendového vzhledu a hodí se ke každému stylu koupelny.

Nábytek SPRING je možno si objednat ve dvou variantách - s hloubkou 40 nebo 46 cm v šesti barevných dekorech s různými barevnými provedeními úchytek.

SPRING je kombinací pěkného koupelnového nábytku za příjemnou cenu.

str. 282



LIVIT: INDUSTRIÁLNÍ ČERNÁ

S řadou koupelnového nábytku Livit nabízíme kvalitní, modulární koncepci nábytku s mnoha kombinovatelnými prvky. K dispozici je vám několik variant umyvadel, spodních skříněk a rámců pomocí kterých si vytvoříte koupelnu svých snů.

str. 314



FROMSCRATCH: DESIGNOVÁ KOLEKCE

FromScratch je designová kolekce společnosti RIHO. Výrobky pocházejí z jedné produktové vývojové řady, u které je kladen důraz na detailní zpracování každého výrobku.

Ty se vyznačují exkluzivním vzhledem, rozpoznatelným podle promyšlených detailů.

Krásné barvy a dřevěné dekory pro skřínky, umyvadla s mnoha možnostmi povrchové úpravy a krycí desky s mnoha variantami umístění umyvadel. S FromScratch přináší do vaší koupelny krásu a eleganci.

str. 404



VPUSŤTE SPRING DO SVÉ KOUPELNY

Spring je nejnovější kolekce koupelnového nábytku RIHO. Série nábytku, která se hodí do každé koupelny díky širokému výběru umyvadel různých velikostí.

Pro větší koupelny nabízíme umyvadla s hloubkou 46 cm. Máte však místa méně? V tom případě si vyberte nábytek s hloubkou 40 cm. Díky dvěma zásuvkám budete mít i tak spoustu úložného prostoru.

Vyberte si ze dvou typů základních variant. Rozhodněte se pro nábytek v dekoru dřeva s rovně seříznutou hranou zásuvek nebo lakované dekory v bílé barvě se skosenou hranou. S koupelnovým nábytkem Spring si můžete být jisti, že dokonale zapadne do vašeho interiéru.

V této kolekci najdete také nábytek s umyvadlem pro vaši toaletu, což je na každé moderní toaletě nepostradatelné a také praktické pro uložení vašich každodenních potřeb.

Spring - nábytek s mnoha druhy madel určenými pro dřevěné dekory

Dopřejte vašemu koupelnovému nábytku úchytky v osobitém stylu. Jsou k dispozici v 5 různých trendových barvách. Rukojeti je možné umístit na spodní skříňky pod umyvadlo i boční skříňky v dekoru dřeva

Barvy Spring	str. 282
Objednací metoda Spring	str. 283
Základní sety Spring Vow	str. 284
Základní sety Spring Rise	str. 288
Základní sety Spring Dew	str. 292
Základní sety Spring Glow	str. 296
Základní sety Spring Blush	str. 300
Základní sety Spring Tablet	str. 304
Kombinovatelné prvky Spring	str. 307
Příslušenství Spring	str. 310



NÁBYTEK SPRING

Barvy Spring



D01
Just Oak



D02
Red Wood

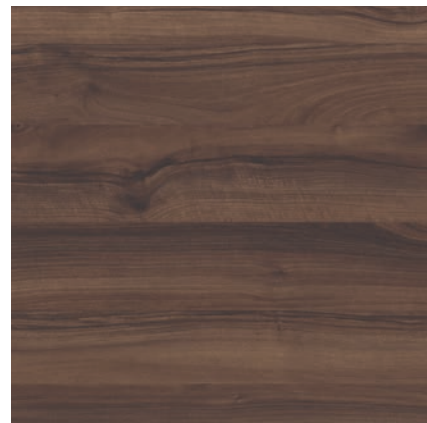

D03
Canella Brown



D04
Charred Black



Z01
Matná bílá lakovaná - LACK



R01
Lesklá bílá lakovaná - LACK

Barvy úchytek



bílá



černá

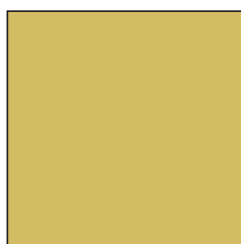

zlatá



matná stříbrná



chrom



černá





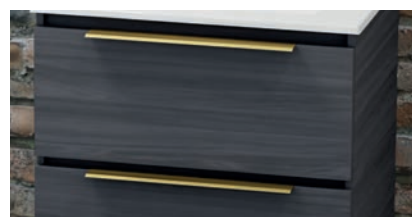



chrom



zlatá

1. Vyberte si typ a hloubku umyvadla:

- Spring Vow
 - Hloubka 20 cm 
 - Hloubka 40 cm
 - Hloubka 46 cm
- Spring Rise
 - Hloubka 20 cm 
 - Hloubka 46 cm
- Spring Dew
 - Hloubka 46 cm 
- Spring Glow
 - Hloubka 46 cm 
- Spring Blush
 - Hloubka 40 cm 
- KRYCÍ DESKY SPRING
 - Hloubka 40 cm 
 - Hloubka 46 cm

Všechna umyvadla jsou k dispozici pouze s otvory pro baterii

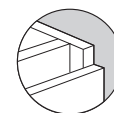

2. Výběr dekoru:

- spodní skříňka s rovně seříznutou hranou zásuvek, k dispozici pouze v dekoru dřeva, s možností montáže úchytek
- spodní skříňka se 45 ° skosenými hranami zásuvek, k dispozici pouze v barvách laku, bez možnosti montáže úchytek

Zadejte barevný kód namísto CODE/LACK

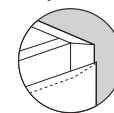

3. Výběr délky umyvadla:

- Můžete si vybrat z těchto délek umyvadel: 40 cm, 60 cm, 80 cm, 100 cm a 120 cm

4. Přizpůsobte nábytek svým potřebám pomocí výběru barevně sladěných úchytek a doplňků

Všechny nábytkové sestavy jsou dodávány s odtokovou soupravou clic-clac.

Úchytky nejsou součástí setu nábytku a je nutné je objednat zvlášť.

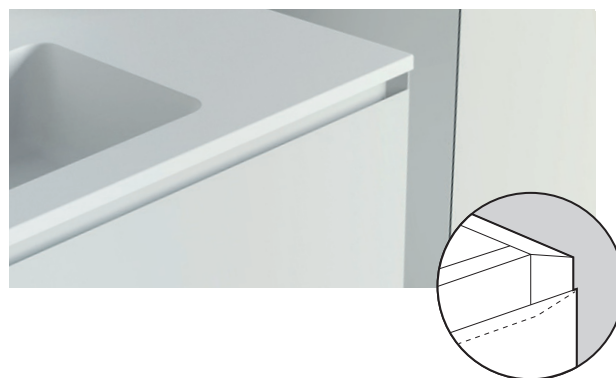



SPRING VOW

MINIMALISTICKÝ DESIGN

Praktický nábytek Spring Vow má elegantní a minimalistický design. Svým moderním vzhledem umyvadla je vhodný pro všechny moderní interiéry koupelen. Umyvadlo je k dispozici v hloubkách 40 a 46 cm a je 8 cm vysoké.

Umyvadla jsou vyrobena z umělého mramoru, materiál je hladký a neporézní, proto se snadno udržuje.



SPRING VOW

- litý mramor
- matná bílá
- výška umyvadla 8 cm
- délka umyvadla 40,60,80,100,120 cm
- hloubka umyvadla 40 nebo 46 cm
- včetně clic-clack v barvě matná bílá
- v délkách 40,60,80,100 s 1 otvorem na baterie, v délkách 100 a 120 cm se 2 otvory na baterie
- verze C pro použití na toaletě



rovná hrana zásuvky - dekor dřeva, možnost úchytek



zkosená hrana zásuvky - dekor lak

Nábytek Spring nabízíme v těchto barvách:

Dekor dřeva - CODE s možností výběru úchytek

312

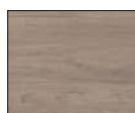

D01
Just Oak



D02
Red Wood



D03
Canella Brown



D04
Charred Black

Matná/Lesklá bílá lakovaná - LACK



Z01
Matná bílá lakovaná - LACK



R01
Lesklá bílá lakovaná - LACK



40 x 20 x 8 cm



60 x 46 x 8 cm

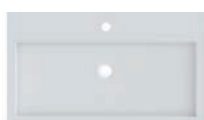

80 x 46 x 8 cm



60 x 40 x 8 cm



80 x 40 x 8 cm

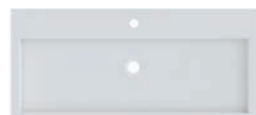

100 x 46 x 8 cm



100 x 46 x 8 cm



100 x 40 x 8 cm



100 x 40 x 8 cm



120 x 46 x 8 cm

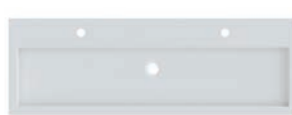

120 x 40 x 8 cm

Nábytek Spring Vow si můžete objednat v těchto setech

Set A

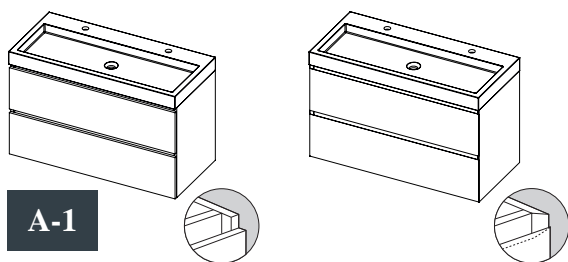

A-1

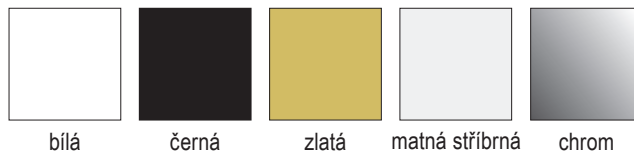

bílá

černá

zlatá

matná stříbrná

chrom

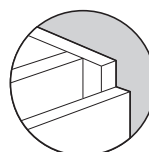

rovná hrana zásuvky - dekor dřeva,
možnost úchytek

Set B

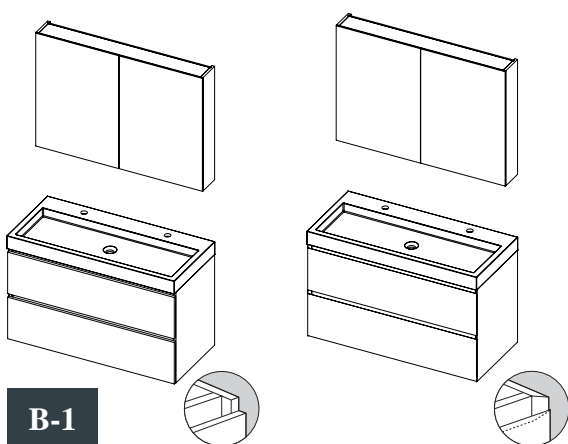

B-1

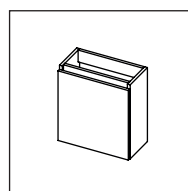

Spodní skříňka

+

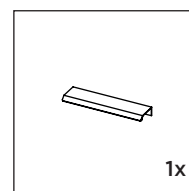

1x

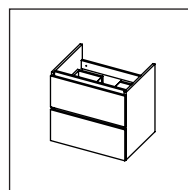

Spodní skříňka 60 cm

+

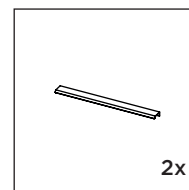

2x

Set C

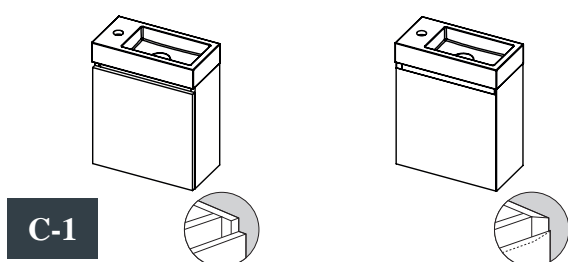

C-1

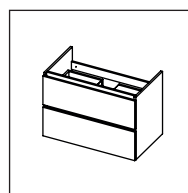

Spodní skříňka 80 cm

+

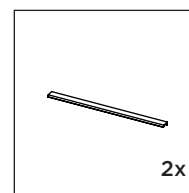

2x

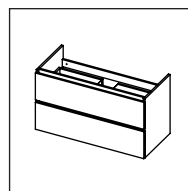

Spodní skříňka 100 cm

+

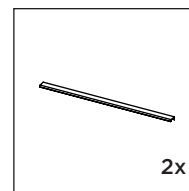

2x

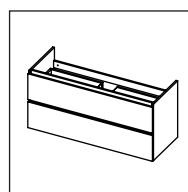

Spodní skříňka 120 cm

+

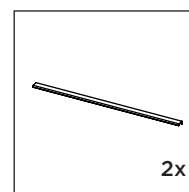

2x

Sety nábytku Spring Wow

A-1

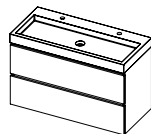

Rozměr nábytku (d x h x v)	Rozměr umyvadla (d x h x v)	Počet otvorů na baterie	Umístění umyvadla	Barva umyvadla	Umístění vyřezu v zásuvce na sifon	Objednací číslo spodních skříněk s rovnou hranou zásuvek - dekor dřeva	Cena	Objednací číslo spodních skříněk se zkosenými hranami - dekor lak	Cena
60 x 40 x 56	60 x 40 x 8	1		<input type="checkbox"/>		F001029CODE	15 404,-/18 639,-	F001253LACK	19 302,-/23 355,-
80 x 40 x 56	80 x 40 x 8	1		<input type="checkbox"/>		F001030CODE	17 144,-/20 744,-	F001254LACK	21 470,-/25 979,-
100 x 40 x 56	100 x 40 x 8	1		<input type="checkbox"/>		F001031CODE	19 212,-/23 247,-	F001255LACK	24 054,-/29 105,-
100 x 40 x 56	100 x 40 x 8	2		<input type="checkbox"/>		F001032CODE	19 212,-/23 247,-	F001256LACK	24 054,-/29 105,-
120 x 40 x 56	120 x 40 x 8	2		<input type="checkbox"/>		F001033CODE	21 358,-/25 843,-	F001257LACK	26 481,-/32 042,-
60 x 46 x 56	60 x 46 x 8	1		<input type="checkbox"/>		F001014CODE	15 549,-/18 814,-	F001238LACK	19 448,-/23 532,-
80 x 46 x 56	80 x 46 x 8	1		<input type="checkbox"/>		F001015CODE	17 369,-/21 016,-	F001239LACK	21 695,-/26 251,-
100 x 46 x 56	100 x 46 x 8	1		<input type="checkbox"/>		F001016CODE	19 415,-/23 492,-	F001240LACK	24 256,-/29 350,-
100 x 46 x 56	100 x 46 x 8	2		<input type="checkbox"/>		F001017CODE	19 415,-/23 492,-	F001241LACK	24 256,-/29 350,-
120 x 46 x 56	120 x 46 x 8	2		<input type="checkbox"/>		F001018CODE	21 605,-/26 142,-	F001242LACK	26 728,-/32 341,-

B-1

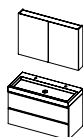

Rozměr nábytku (d x h x v)	Rozměr umyvadla (d x h x v)	Počet otvorů na baterie	Umístění umyvadla	Barva umyvadla	Umístění vyřezu v zásuvce na sifon	Objednací číslo spodních skříněk s rovnou hranou zásuvek - dekor dřeva	Cena	Objednací číslo spodních skříněk se zkosenými hranami - dekor lak	Cena
60 x 40 x 56	60 x 40 x 8	1		<input type="checkbox"/>		F001105CODE	24 841,-/30 058,-	F001329LACK	28 009,-/33 891,-
80 x 40 x 56	80 x 40 x 8	1		<input type="checkbox"/>		F001106CODE	30 301,-/36 664,-	F001330LACK	33 874,-/40 988,-
100 x 40 x 56	100 x 40 x 8	1		<input type="checkbox"/>		F001107CODE	33 447,-/40 471,-	F001331LACK	37 166,-/44 971,-
100 x 40 x 56	100 x 40 x 8	2		<input type="checkbox"/>		F001108CODE	33 447,-/40 471,-	F001332LACK	37 166,-/44 971,-
120 x 40 x 56	120 x 40 x 8	2		<input type="checkbox"/>		F001109CODE	37 053,-/44 834,-	F001333LACK	40 604,-/49 131,-
60 x 46 x 56	60 x 46 x 8	1		<input type="checkbox"/>		F001090CODE	24 975,-/30 220,-	F001314LACK	28 155,-/34 068,-
80 x 46 x 56	80 x 46 x 8	1		<input type="checkbox"/>		F001091CODE	30 537,-/36 950,-	F001315LACK	34 109,-/41 272,-
100 x 46 x 56	100 x 46 x 8	1		<input type="checkbox"/>		F001092CODE	33 649,-/40 715,-	F001316LACK	37 379,-/45 229,-
100 x 46 x 56	100 x 46 x 8	2		<input type="checkbox"/>		F001093CODE	33 649,-/40 715,-	F001317LACK	37 379,-/45 229,-
120 x 46 x 56	120 x 46 x 8	2		<input type="checkbox"/>		F001094CODE	37 289,-/45 120,-	F001318LACK	40 850,-/49 429,-

C-1

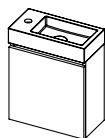

Rozměr nábytku (d x h x v)	Rozměr umyvadla (d x h x v)	Počet otvorů na baterie	Umístění umyvadla	Barva umyvadla	Umístění vyřezu v zásuvce na sifon	Objednací číslo spodních skříněk s rovnou hranou zásuvek - dekor dřeva	Cena	Objednací číslo spodních skříněk se zkosenými hranami - dekor lak	Cena
40 x 20 x 42	40 x 20 x 8	1		<input type="checkbox"/>		F001038CODE	9 729,-/11 772,-	F001262LACK	12 437,-/15 049,-



SPRING RISE

MODERNÍ A KLASICKÝ

Tato varianta nábytku SPRING se vyznačuje vysokým keramickým umyvadlem. Ať si pro vaši koupelnu vyberete jakýkoliv styl, tento typ robustního umyvadla se do ní bude jistě hodit.

Keramika je lesklá, odolná proti poškrábání a snadná na údržbu.

Umyvadlo je k dispozici v šířce 46 cm .

SPRING RISE

- keramické umyvadlo
- lesklá bílá barva
- výška umyvadla 12 cm
- délka umyvadla 40,60,80,100,120 cm
- hloubka umyvadla 46 cm
- včetně clic-clack chrom
- v délkách 40,60,80,100 s 1 otvorem na baterie, v délkách 100 a 120 cm se 2 otvory na baterie
- verze C pro použití na toaletě



rovná hrana zásuvky - dekor dřeva, možnost úchytok



zkosená hrana zásuvky - dekor lak



Nábytek Spring nabízíme v těchto barvách:

Dekor dřeva - CODE s možností výběru úchytok

312



D01
Just Oak



D02
Red Wood

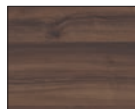

D03
Canella Brown



D04
Charred Black

Matná/Lesklá bílá lakovaná - LACK



Z01
Matná bílá lakovaná - LACK

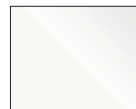

R01
Lesklá bílá lakovaná - LACK



40 x 20 x 12 cm



60 x 46 x 12 cm



80 x 46 x 12 cm

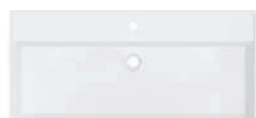

100 x 46 x 12 cm



100 x 46 x 12 cm



120 x 46 x 12 cm

Nábytek Spring Rise si můžete objednat v těchto setech

Set A

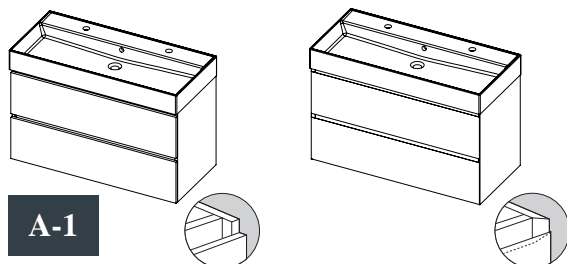

A-1

ÚCHYTKY

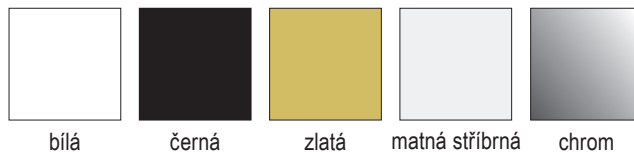

bílá

černá

zlatá

matná stříbrná

chrom

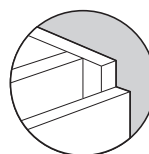

rovná hrana zásuvky - dekor dřeva,
možnost úchytek

Set B

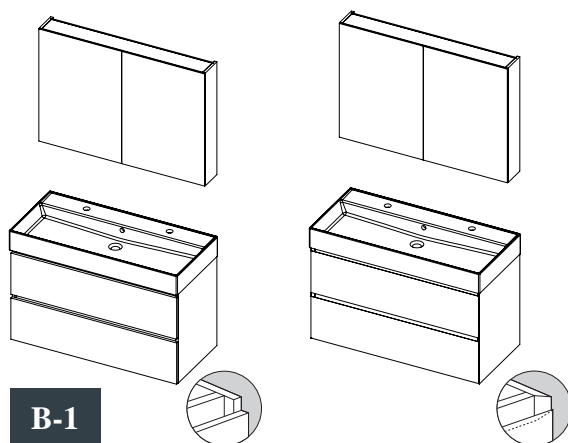

B-1

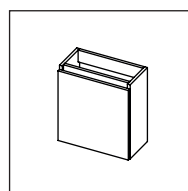

Spodní skříňka

+

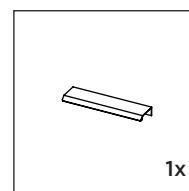

1x

Úchytka 15 cm

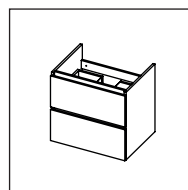

Spodní skříňka 60 cm

+

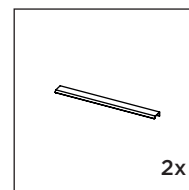

2x

Úchytka 40 cm

Set C

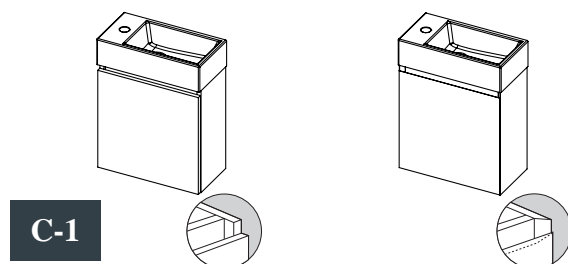

C-1

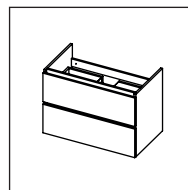

Spodní skříňka 80 cm

+

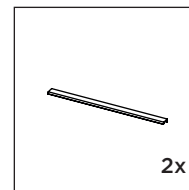

2x

Úchytka 60cm

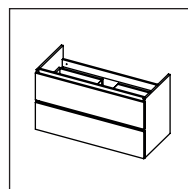

Spodní skříňka 100 cm

+

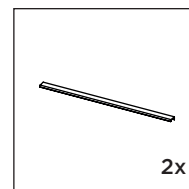

2x

Úchytka 75 cm

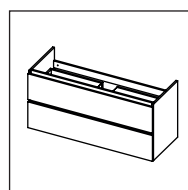

Spodní skříňka 120 cm

+

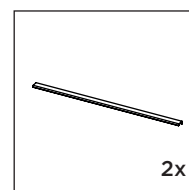

2x

Úchytka 90 cm

Sety nábytku Spring Rise

A-1

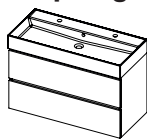

Rozměr nábytku (d x h x v)	Rozměr umyvadla (d x h x v)	Počet otvorů na baterie	Umístění umyvadla	Barva umyvadla	Umístění vyřezu v zásuvce na sifon	Objednací číslo spodních skříněk s rovnou hranou zásuvek - dekor dřeva	Cena	Objednací číslo spodních skříněk se zkosenými hranami - dekor lak	Cena
60 x 40 x 56	60 x 46 x 12	1		<input type="checkbox"/>		F001005CODE	15 695,-/18 991,-	F001229LACK	18 875,-/22 839,-
80 x 40 x 56	80 x 46 x 12	1		<input type="checkbox"/>		F001006CODE	17 122,-/20 718,-	F001230LACK	20 718,-/25 069,-
100 x 40 x 56	100 x 46 x 12	1		<input type="checkbox"/>		F001007CODE	19 874,-/24 048,-	F001231LACK	23 998,-/29 038,-
100 x 40 x 56	100 x 46 x 12	2		<input type="checkbox"/>		F001008CODE	19 874,-/24 048,-	F001232LACK	23 998,-/29 038,-
120 x 40 x 56	120 x 46 x 12	2		<input type="checkbox"/>		F001009CODE	23 560,-/28 508,-	F001233LACK	27 964,-/33 836,-

B-1

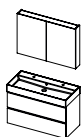

Rozměr nábytku (d x h x v)	Rozměr umyvadla (d x h x v)	Počet otvorů na baterie	Umístění umyvadla	Barva umyvadla	Umístění vyřezu v zásuvce na sifon	Objednací číslo spodních skříněk s rovnou hranou zásuvek - dekor dřeva	Cena	Objednací číslo spodních skříněk se zkosenými hranami - dekor lak	Cena
60 x 40 x 56	60 x 46 x 12	1		<input type="checkbox"/>		F001081CODE	25 133,-/30 411,-	F001305LACK	27 582,-/33 374,-
80 x 40 x 56	80 x 46 x 12	1		<input type="checkbox"/>		F001082CODE	30 267,-/36 623,-	F001306LACK	33 121,-/40 076,-
100 x 40 x 56	100 x 46 x 12	1		<input type="checkbox"/>		F001083CODE	34 109,-/41 272,-	F001307LACK	37 098,-/44 889,-
100 x 40 x 56	100 x 46 x 12	2		<input type="checkbox"/>		F001084CODE	34 109,-/41 272,-	F001308LACK	37 098,-/44 889,-
120 x 40 x 56	120 x 46 x 12	2		<input type="checkbox"/>		F001085CODE	39 255,-/47 499,-	F001309LACK	42 076,-/50 912,-

C-1

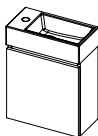

Rozměr nábytku (d x h x v)	Rozměr umyvadla (d x h x v)	Počet otvorů na baterie	Umístění umyvadla	Barva umyvadla	Umístění vyřezu v zásuvce na sifon	Objednací číslo spodních skříněk s rovnou hranou zásuvek - dekor dřeva	Cena	Objednací číslo spodních skříněk se zkosenými hranami - dekor lak	Cena
40 x 20 x 42	40 x 20 x 12	1		<input type="checkbox"/>		F001449CODE	8 438,-/10 210,-	F001453LACK	11 156,-/13 499,-
40 x 20 x 42	40 x 20 x 12	1		<input type="checkbox"/>		F001450CODE	8 438,-/10 210,-	F001454LACK	11 156,-/13 499,-



SPRING DEW

MODERNÍ DESIGN



Toto elegantní umyvadlo je pouze 1,5 cm vysoké a 46 cm široké. Elegantní design, tenké linky s čistými okraji.

Umyvadlo je dodáváno v délkách 60, 80 nebo 100 s jedním mycím prostorem a v délce 120 cm se dvěma mycími prostory.

Umyvadlo Spring Dew je vyrobeno z litého mramoru v matné bílé barvě. Tento materiál je neporézní velmi snadný na údržbu. Proto se snadno udržuje

SPRING DEW

- litý mramor
- matná bílá
- výška umyvadla 1,6 cm
- délka umyvadla 60,80,100,120 cm
- hloubka umyvadla 46 cm
- včetně clic-clack v barvě matná bílá
- v délkách 60,80,100 s 1 otvorem na baterie, v délce 120 cm se 2 otvory na baterie

-  rovná hrana zásuvky - dekor dřeva, možnost úchytek
-  zkosená hrana zásuvky - dekor lak



Nábytek Spring nabízíme v těchto barvách:

Dekor dřeva - CODE s možností výběru úchytek

312



D01 Just Oak



D02 Red Wood



D03 Canella Brown



D04 Charred Black

Matná/Lesklá bílá lakovaná - LACK



Z01 Matná bílá lakovaná - LACK

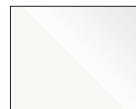

R01 Lesklá bílá lakovaná - LACK



60 x 46 x 12 cm



80 x 46 x 12 cm



100 x 46 x 12 cm



120 x 46 x 12 cm



Nábytek Spring Dew si můžete objednat v těchto setech

Set A

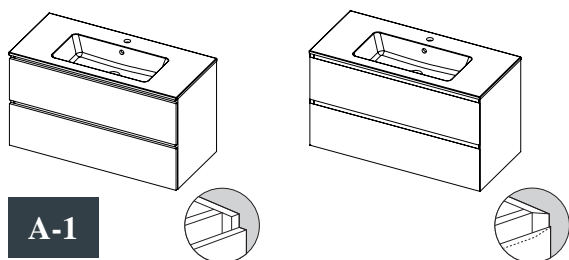

A-1

Set B

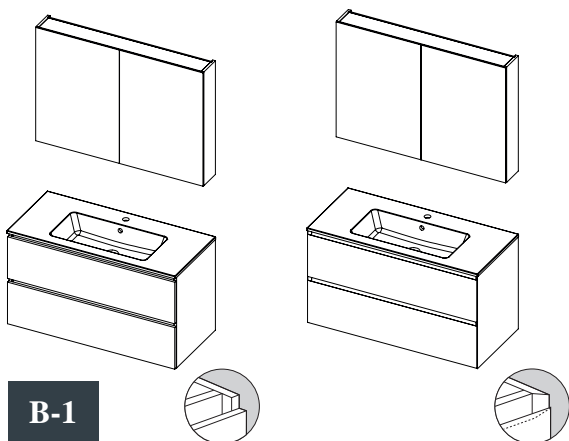

B-1

ÚCHYTKY

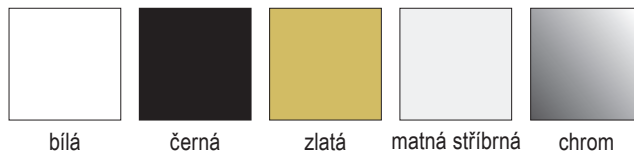

bílá

černá

zlatá

matná stříbrná

chrom

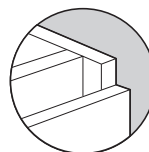

rovná hrana zásuvky - dekor dřeva,
možnost úchytek

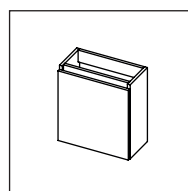

Spodní skříňka

+

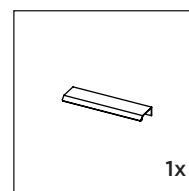

1x

Úchytka 15 cm

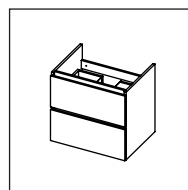

Spodní skříňka 60 cm

+

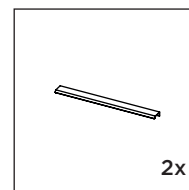

2x

Úchytka 40 cm

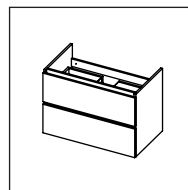

Spodní skříňka 80 cm

+

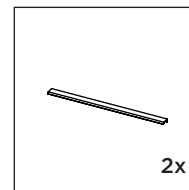

2x

Úchytka 60cm

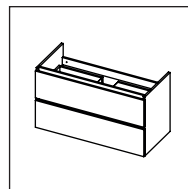

Spodní skříňka 100 cm

+

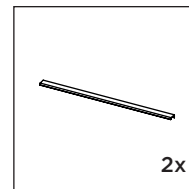

2x

Úchytka 75 cm

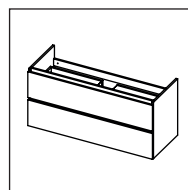

Spodní skříňka 120 cm

+

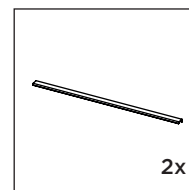

2x

Úchytka 90 cm

Sety nábytku Spring Dew

A-1

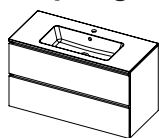

Rozměr nábytku (d x h x v)	Rozměr umyvadla (d x h x v)	Počet otvorů na baterie	Umístění umyvadla	Barva umyvadla	Umístění vyřezu v zásuvce na sifon	Objednací číslo spodních skříněk s rovnou hranou zásuvek - dekor dřeva	Cena	Objednací číslo spodních skříněk se zkosenými hranami - dekor lak	Cena
60 x 46 x 56	60 x 46 x 1,6	1		<input type="checkbox"/>		F001010CODE	16 538,-/20 011,-	F001234LACK	19 706,-/23 844,-
80 x 46 x 56	80 x 46 x 1,6	1		<input type="checkbox"/>		F001011CODE	18 347,-/22 200,-	F001235LACK	21 953,-/26 563,-
100 x 46 x 56	100 x 46 x 1,6	1		<input type="checkbox"/>		F001012CODE	20 436,-/24 728,-	F001236LACK	24 560,-/29 718,-
120 x 46 x 56	120 x 46 x 1,6	2		<input type="checkbox"/>		F001013CODE	25 728,-/31 131,-	F001237LACK	30 121,-/36 446,-

B-1

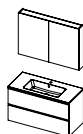

Rozměr nábytku (d x h x v)	Rozměr umyvadla (d x h x v)	Počet otvorů na baterie	Umístění umyvadla	Barva umyvadla	Umístění vyřezu v zásuvce na sifon	Objednací číslo spodních skříněk s rovnou hranou zásuvek - dekor dřeva	Cena	Objednací číslo spodních skříněk se zkosenými hranami - dekor lak	Cena
60 x 46 x 56	60 x 46 x 1,6	1		<input type="checkbox"/>		F001086CODE	25 964,-/31 416,-	F001310LACK	28 413,-/34 380,-
80 x 46 x 56	80 x 46 x 1,6	1		<input type="checkbox"/>		F001087CODE	31 503,-/38 119,-	F001311LACK	34 357,-/41 572,-
100 x 46 x 56	100 x 46 x 1,6	1		<input type="checkbox"/>		F001088CODE	34 671,-/41 952,-	F001312LACK	37 659,-/45 567,-
120 x 46 x 56	120 x 46 x 1,6	2		<input type="checkbox"/>		F001089CODE	41 412,-/50 109,-	F001313LACK	44 244,-/53 535,-



SPRING GLOW

NADČASOVÁ KLASIKA

Spring Glow je elegantní keramické umyvadlo v šířce 46 cm. Vytvořte si díky tomuto umyvadlu nadčasovou atmosféru ve vaší koupelně. Umyvadlo je k dispozici v délce 60, 80 a 100 cm s jedním mycím místem a v délce 120 cm se dvěma mycími místy.

SPRING GLOW

- keramické umyvadlo
- lesklá bílá
- výška umyvadla 1,5 cm
- délka umyvadla 60,80,100,120 cm
- hloubka umyvadla 46 cm
- včetně clic-clack chrom
- v délkách 60,80,100 s 1 otvorem na baterie, v délce 120 cm se 2 otvory na baterie



rovná hrana zásuvky - dekor dřeva, možnost úchytek



zkosená hrana zásuvky - dekor lak

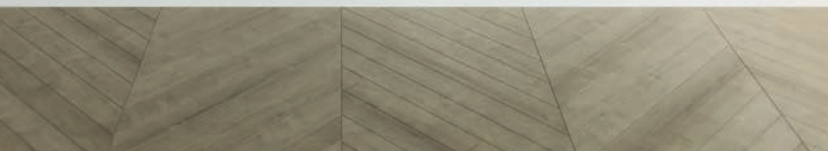

Nábytek Spring nabízíme v těchto barvách:

Dekor dřeva - CODE s možností výběru úchytek

312



D01
Just Oak



D02
Red Wood

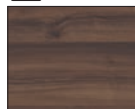

D03
Canella Brown



D04
Charred Black

Matná/Lesklá bílá lakovaná - LACK



Z01
Matná bílá lakovaná - LACK

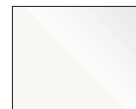

R01
Lesklá bílá lakovaná - LACK



60 x 46 x 12 cm



80 x 46 x 12 cm



100 x 46 x 12 cm



120 x 46 x 12 cm

Nábytek Spring Glow si můžete objednat v těchto setech

Set A

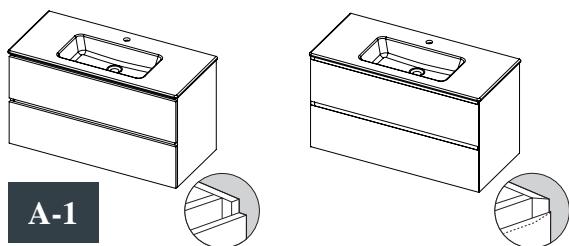

A-1

Set B

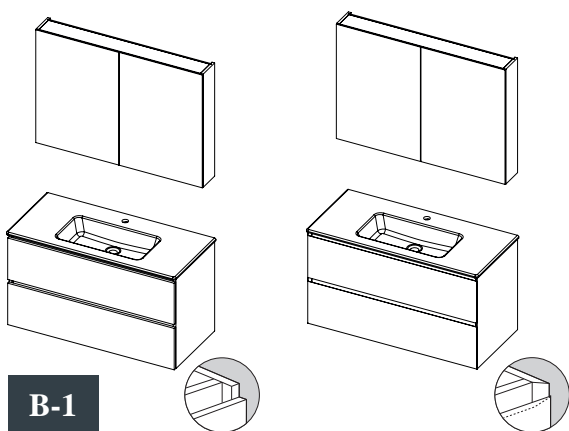

B-1

ÚCHYTKY

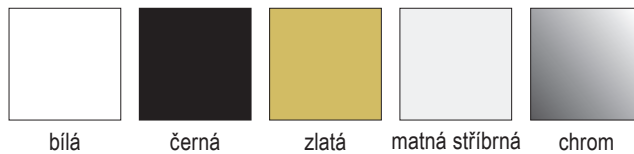

bílá

černá

zlatá

matná stříbrná

chrom

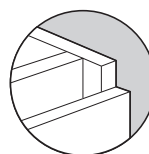

rovná hrana zásuvky - dekor dřeva, možnost úchytek

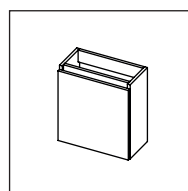

Spodní skříňka

+

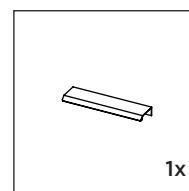

1x

Úchytka 15 cm

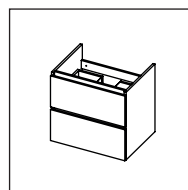

Spodní skříňka 60 cm

+

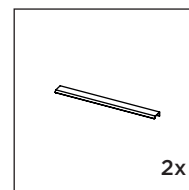

2x

Úchytka 40 cm

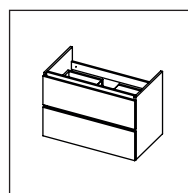

Spodní skříňka 80 cm

+

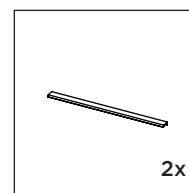

2x

Úchytka 60cm

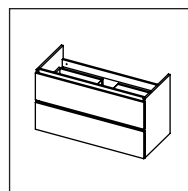

Spodní skříňka 100 cm

+

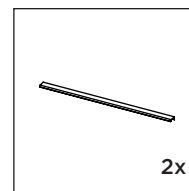

2x

Úchytka 75 cm

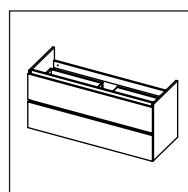

Spodní skříňka 120 cm

+

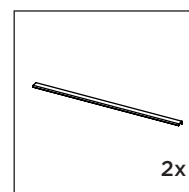

2x

Úchytka 90 cm

Sety nábytku Spring Glow

A-1

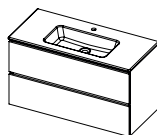

Rozměr nábytku (d x h x v)	Rozměr umyvadla (d x h x v)	Počet otvorů na baterie	Umístění umyvadla	Barva umyvadla	Umístění výřezu v zásuvce na sifon	Objednací číslo spodních skříněk s rovnou hranou zásuvek - dekor dřeva	Cena	Objednací číslo spodních skříněk se zkosenými hranami - dekor lak	Cena
60 x 46 x 56	60 x 46 x 1,5	1		<input type="checkbox"/>				F001225LACK	19 415,-/23 492,-
80 x 46 x 56	80 x 46 x 1,5	1		<input type="checkbox"/>		F001002CODE	18 447,-/22 321,-	F001226LACK	22 054,-/26 685,-
100 x 46 x 56	100 x 46 x 1,5	1		<input type="checkbox"/>		F001003CODE	20 549,-/24 864,-	F001227LACK	24 661,-/29 840,-
120 x 46 x 56	120 x 46 x 1,5	2		<input type="checkbox"/>		F001004CODE	29 402,-/35 576,-	F001228LACK	33 278,-/40 266,-

B-1

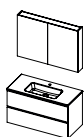

Rozměr nábytku (d x h x v)	Rozměr umyvadla (d x h x v)	Počet otvorů na baterie	Umístění umyvadla	Barva umyvadla	Umístění výřezu v zásuvce na sifon	Objednací číslo spodních skříněk s rovnou hranou zásuvek - dekor dřeva	Cena	Objednací číslo spodních skříněk se zkosenými hranami - dekor lak	Cena
60 x 46 x 56	60 x 46 x 1,5	1		<input type="checkbox"/>				F001301LACK	28 121,-/34 026,-
80 x 46 x 56	80 x 46 x 1,5	1		<input type="checkbox"/>		F001078CODE	31 604,-/38 241,-	F001302LACK	34 458,-/41 694,-
100 x 46 x 56	100 x 46 x 1,5	1		<input type="checkbox"/>		F001079CODE	34 761,-/42 061,-	F001303LACK	37 772,-/45 704,-
120 x 46 x 56	120 x 46 x 1,5	2		<input type="checkbox"/>		F001080CODE	45 098,-/54 569,-	F001304LACK	47 918,-/57 981,-



SPRING BLUSH

TRENDOVÉ UMYVADLO S TENKÝM OKRAJEM

Umyvadlo Spring Blush je umyvadlo vyrobené z litého mramoru v bílé matné barvě s tenkým okrajem ve výšce 1,5 cm. Jedná se o neporézní materiál snadný na údržbu.

Hloubka umyvadla je 40 cm

SPRING BLUSH

- litý mramor
- matná bílá
- výška umyvadla 1,5 cm
- délka umyvadla 60,80,100,120 cm
- hloubka umyvadla 40 cm
- včetně clic-clack v barvě matná bílá
- v délkách 60,80,100 s 1 otvorem na baterie



rovná hrana zásuvky - dekor dřeva, možnost úchytek



zkosená hrana zásuvky - dekor lak

Nábytek Spring nabízíme v těchto barvách:

Dekor dřeva - CODE s možností výběru úchytek

312

Matná/Lesklá bílá lakovaná - LACK



D01 Just Oak



D02 Red Wood

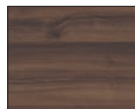

D03 Canella Brown



D04 Charred Black



Z01 Matná bílá lakovaná - LACK

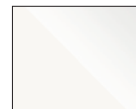

R01 Lesklá bílá lakovaná - LACK



60 x 40 x 12 cm



80 x 40 x 12 cm



100 x 40 x 12 cm



120 x 40 x 12 cm



Nábytek Spring Blush si můžete objednat v těchto setech

Set A

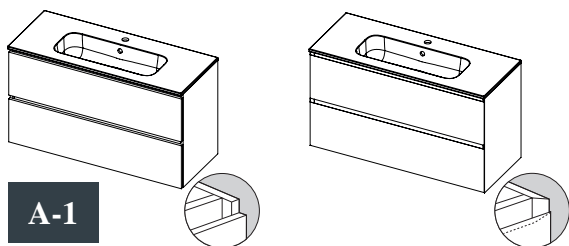

A-1

ÚCHYTKY

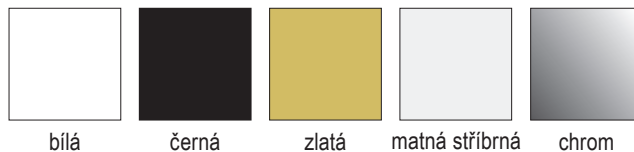

bílá

černá

zlatá

matná stříbrná

chrom

Set B

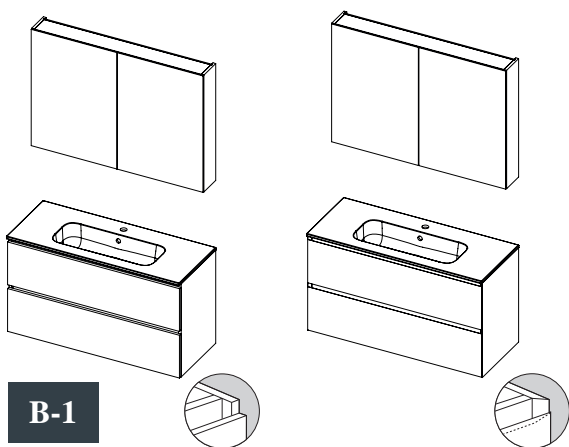

B-1

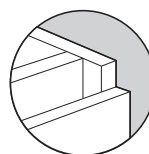

rovná hrana zásuvky - dekor dřeva,
možnost úchytek

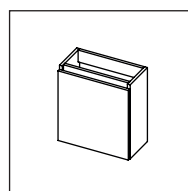

Spodní skříňka

+

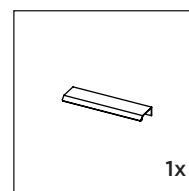

1x

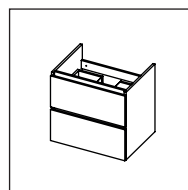

Spodní skříňka 60 cm

+

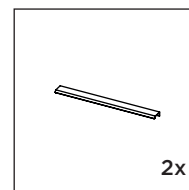

2x

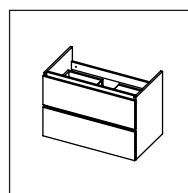

Spodní skříňka 80 cm

+

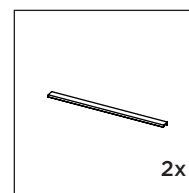

2x

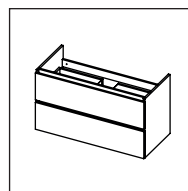

Spodní skříňka 100 cm

+

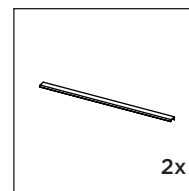

2x

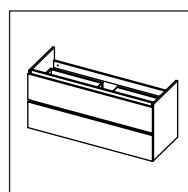

Spodní skříňka 120 cm

+

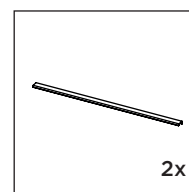

2x

Sety nábytku Spring Blush

A-1

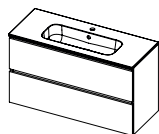

Rozměr nábytku (d x h x v)	Rozměr umyvadla (d x h x v)	Počet otvorů na baterie	Umístění umyvadla	Barva umyvadla	Umístění výřezu v zásuvce na sifon	Objednací číslo spodních skříněk s rovnou hranou zásuvek - dekor dřeva	Cena	Objednací číslo spodních skříněk se zkosenými hranami - dekor lak	Cena
60 x 40 x 56	60 x 40 x 1,5	1		<input type="checkbox"/>		F001024CODE	16 807,-/20 336,-	F001248LACK	19 976,-/24 171,-
80 x 40 x 56	80 x 40 x 1,5	1		<input type="checkbox"/>		F001025CODE	19 886,-/24 062,-	F001249LACK	23 493,-/28 427,-
100 x 40 x 56	100 x 40 x 1,5	1		<input type="checkbox"/>		F001026CODE	21 437,-/25 939,-	F001250LACK	25 560,-/30 928,-
120 x 40 x 56	120 x 40 x 1,5	2		<input type="checkbox"/>		F001028CODE	23 863,-/28 874,-	F001252LACK	28 267,-/34 203,-

B-1

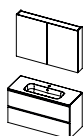

Rozměr nábytku (d x h x v)	Rozměr umyvadla (d x h x v)	Počet otvorů na baterie	Umístění umyvadla	Barva umyvadla	Umístění výřezu v zásuvce na sifon	Objednací číslo spodních skříněk s rovnou hranou zásuvek - dekor dřeva	Cena	Objednací číslo spodních skříněk se zkosenými hranami - dekor lak	Cena
60 x 40 x 56	60 x 40 x 1,5	1		<input type="checkbox"/>		F001100CODE	26 245,-/31 756,-	F001324LACK	28 683,-/34 706,-
80 x 40 x 56	80 x 40 x 1,5	1		<input type="checkbox"/>		F001101CODE	33 042,-/39 981,-	F001325LACK	35 896,-/43 434,-
100 x 40 x 56	100 x 40 x 1,5	1		<input type="checkbox"/>		F001102CODE	35 672,-/43 163,-	F001326LACK	38 670,-/46 791,-
120 x 40 x 56	120 x 40 x 1,5	2		<input type="checkbox"/>		F001104CODE	39 547,-/47 852,-	F001328LACK	42 378,-/51 277,-



SPRING TABLET

ELEGANTNÍ DESIGN

Tato elegantní krycí deska má tloušťku 3 cm a je k dispozici ve všech dřevěných dekorech a lakových barvách.

Můžete si vybrat ze šířek 40 cm nebo 46 cm.

Krycí desky můžete kombinovat se všemi umyvadly z kolekce koupelnového nábytku RIHO Livit nebo z kolekce RIHO FromScratch.

KRYCÍ DESKY SPRING

- krycí deska dekor dřevo nebo lak
- tloušťka krycí desky 3 cm
- délka krycí desky 60,80,100,120 cm
- hloubka krycí desky 40 nebo 46 cm



rovná hrana zásuvky - dekor dřeva, možnost úchytek



zkosená hrana zásuvky - dekor lak



Nábytek Spring nabízíme v těchto barvách:

Dekor dřeva - CODE s možností výběru úchytek 312



D01
Just Oak



D02
Red Wood



D03
Canella Brown



D04
Charred Black

Matná/Lesklá bílá lakovaná - LACK



Z01
Matná bílá lakovaná - LACK

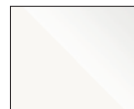

R01
Lesklá bílá lakovaná - LACK

Keramická umyvadla



bílá mat
W032001105

34,6x11,4 cm

4 236,-/5 126,-



bílá lesk
W032001005

34,6x11,4 cm

4 236,-/5 126,-

Krycí desky Spring si můžete objednat v těchto setech

Set A

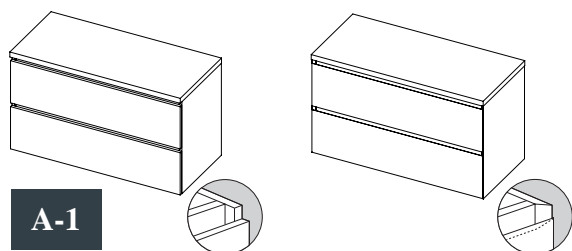

A-1

Set B

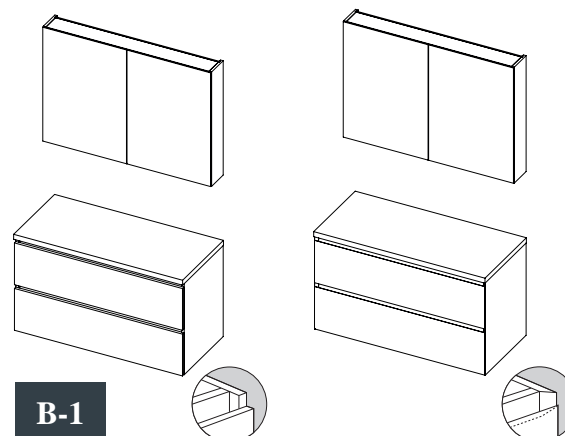

B-1

SETY SKŘÍŇEK S KRYCÍMI DESKAMI

A-1

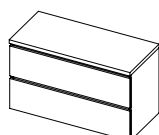





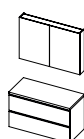





Rozměr nábytku (d x h x v)	Rozměr krycí desky (d x š x v)	Umístění výřezu v zásuvce na sifon	Objednávací číslo spodních skříněk s rovnou hranou zásuvek - dekor dřeva	Cena	Objednávací číslo spodních skříněk se zkosenými hranami - dekor lak	Cena
60 x 40 x 56	60 x 40 x 3		F001034CODE	13 920,-/16 843,-	F001258LACK	17 549,-/21 234,-
80 x 40 x 56	80 x 40 x 3		F001035CODE	15 291,-/18 502,-	F001259LACK	19 437,-/23 519,-
100 x 40 x 56	100 x 40 x 3		F001036CODE	17 381,-/21 031,-	F001260LACK	21 246,-/25 708,-
120 x 40 x 56	120 x 40 x 3		F001037CODE	18 684,-/22 608,-	F001261LACK	23 571,-/28 521,-
60 x 46 x 56	60 x 46 x 3		F001019CODE	13 920,-/16 843,-	F001243LACK	17 549,-/21 234,-
80 x 46 x 56	80 x 46 x 3		F001020CODE	15 291,-/18 502,-	F001244LACK	19 437,-/23 519,-
100 x 46 x 56	100 x 46 x 3		F001021CODE	17 381,-/21 031,-	F001245LACK	21 246,-/25 708,-
120 x 46 x 56	120 x 46 x 3		F001022CODE	18 684,-/22 608,-	F001246LACK	23 571,-/28 521,-
120 x 46 x 56	120 x 46 x 3		F001023CODE	19 987,-/24 184,-	F001247LACK	24 886,-/30 112,-

B-1



Rozměr nábytku (d x h x v)	Rozměr krycí desky (d x š x v)	Umístění výřezu v zásuvce na sifon	Objednávací číslo spodních skříněk s rovnou hranou zásuvek - dekor dřeva	Cena	Objednávací číslo spodních skříněk se zkosenými hranami - dekor lak	Cena
60 x 40 x 56	60 x 40 x 3		F001110CODE	23 357,-/28 262,-	F001334LACK	26 256,-/31 770,-
80 x 40 x 56	80 x 40 x 3		F001111CODE	28 458,-/34 434,-	F001335LACK	31 829,-/38 513,-
100 x 40 x 56	100 x 40 x 3		F001112CODE	31 616,-/38 255,-	F001336LACK	34 346,-/41 559,-
120 x 40 x 56	120 x 40 x 3		F001113CODE	34 368,-/41 585,-	F001337LACK	37 682,-/45 595,-
60 x 46 x 56	60 x 46 x 3		F001095CODE	23 357,-/28 262,-	F001319LACK	26 256,-/31 770,-
80 x 46 x 56	80 x 46 x 3		F001096CODE	28 458,-/34 434,-	F001320LACK	31 829,-/38 513,-
100 x 46 x 56	100 x 46 x 3		F001097CODE	31 616,-/38 255,-	F001321LACK	34 346,-/41 559,-
120 x 46 x 56	120 x 46 x 3		F001098CODE	34 368,-/41 585,-	F001322LACK	37 682,-/45 595,-
120 x 46 x 56	120 x 46 x 3		F001099CODE	35 682,-/43 175,-	F001323LACK	38 997,-/47 186,-





VARIANTY UMYVADEL SPRING WOW

	Obj. č.	Popis	Rozměr umyvadla (d x h x v)	Cena
	W004001105	Umyvadlo Spring Wow 1 otvor na baterii Litý mramor matná bílá barva	60 x 46 x 8	5 472,-/6 621,-
	W004002105	Umyvadlo Spring Wow 1 otvor na baterii Litý mramor matná bílá barva	80 x 46 x 8	6 617,-/8 007,-
	W004003105	Umyvadlo Spring Wow 1 otvor na baterii Litý mramor matná bílá barva	100 x 46 x 8	8 168,-/9 883,-
	W004004105	Umyvadlo Spring Wow 2 otvory na baterii Litý mramor matná bílá barva	100 x 46 x 8	8 168,-/9 883,-
	W004005105	Umyvadlo Spring Wow 2 otvory na baterii Litý mramor matná bílá barva	120 x 46 x 8	9 561,-/11 569,-
	W004006105	Umyvadlo Spring Wow 1 otvor na baterii Litý mramor matná bílá barva	60 x 40 x 8	5 303,-/6 417,-
	W004007105	Umyvadlo Spring Wow 1 otvor na baterii Litý mramor matná bílá barva	80 x 40 x 8	6 337,-/7 668,-
	W004008105	Umyvadlo Spring Wow 1 otvor na baterii Litý mramor matná bílá barva	100 x 40 x 8	7 910,-/9 571,-
	W004009105	Umyvadlo Spring Wow 2 otvory na baterii Litý mramor matná bílá barva	100 x 40 x 8	7 910,-/9 571,-
	W004010105	Umyvadlo Spring Wow 2 otvory na baterii Litý mramor matná bílá barva	120 x 40 x 8	9 269,-/11 215,-
	W004011105	Umyvadlo Spring Wow 1 otvor na baterii Litý mramor matná bílá barva	40 x 20 x 8	4 157,-/5 030,-





VARIANTY UMYVADEL SPRING RISE

	Obj. č.	Popis	Rozměr umyvadla (d x h x v)	Cena
	W005001005	Umyvadlo Spring Rise 1 otvor na baterii Bílá keramika	60 x 46 x 12	5 787,-/7 002,-
	W005002005	Umyvadlo Spring Rise 1 otvor na baterii Bílá keramika	80 x 46 x 12	6 416,-/7 763,-
	W005003005	Umyvadlo Spring Rise 1 otvor na baterii Bílá keramika	100 x 46 x 12	8 820,-/10 672,-
	W005004005	Umyvadlo Spring Rise 2 otvory na baterii Bílá keramika	100 x 46 x 12	8 820,-/10 672,-
	W005005005	Umyvadlo Spring Rise 2 otvory na baterii Bílá keramika	120 x 46 x 12	12 033,-/14 560,-
	W012001005	Umyvadlo Spring Rise 1 otvor na baterii Bílá keramika	41 x 20 x 12	2 371,-/2 869,-
	W012002005	Umyvadlo Spring Rise 1 otvor na baterii Bílá keramika	41 x 20 x 12	2 371,-/2 869,-





VARIANTY UMYVADEL SPRING DEW

	Obj. č.	Popis	Rozměr umyvadla (d x h x v)	Cena
	W003001105	Umyvadlo Spring Dew 1 otvor na baterii Litý mramor matná bílá barva	60 x 46 x 1,6	6 662,-/8 061,-
	W003002105	Umyvadlo Spring Dew 1 otvor na baterii Litý mramor matná bílá barva	80 x 46 x 1,6	7 774,-/9 407,-
	W003003105	Umyvadlo Spring Dew 1 otvor na baterii Litý mramor matná bílá barva	100 x 46 x 1,6	9 392,-/11 364,-
	W003005105	Umyvadlo Spring Dew 2 otvory na baterii Litý mramor matná bílá barva	120 x 46 x 1,6	12 191,-/14 751,-



VARIANTY UMYVADEL SPRING GLOW

	Obj. č.	Popis	Rozměr umyvadla (d x h x v)	Cena
	W001001005	Umyvadlo Spring Glow 1 otvor na baterii Bílá keramika	60 x 46 x 1,5	6 416,-/7 763,-
	W001002005	Umyvadlo Spring Glow 1 otvor na baterii Bílá keramika	80 x 46 x 1,5	8 022,-/9 707,-
	W001003005	Umyvadlo Spring Glow 1 otvor na baterii Bílá keramika	100 x 46 x 1,5	9 629,-/11 651,-
	W001004005	Umyvadlo Spring Glow 2 otvory na baterii Bílá keramika	120 x 46 x 1,5	16 841,-/20 378,-

VARIANTY UMYVADEL SPRING BLUSH

	Obj. č.	Popis	Rozměr umyvadla (d x h x v)	Cena
	W002001105	Umyvadlo Spring Blush 1 otvor na baterii Litý mramor matná bílá barva	60 x 46 x 1,5	6 988,-/8 455,-
	W002002105	Umyvadlo Spring Blush 1 otvor na baterii Litý mramor matná bílá barva	80 x 46 x 1,5	9 629,-/11 651,-
	W002003105	Umyvadlo Spring Blush 1 otvor na baterii Litý mramor matná bílá barva	100 x 46 x 1,5	10 595,-/12 820,-
	W002005105	Umyvadlo Spring Blush 1 otvor na baterii Litý mramor matná bílá barva	120 x 46 x 1,5	12 268,-/14 844,-

KERAMICKÁ UMYVADLA

	Obj. č.	Popis	Rozměr umyvadla (d x h x v)	Cena
	W032001105	keramická umyvadla bílá mat	34,6 x 11,4 cm	4 236,-/5 126,-
	W032001005	keramická umyvadla bílá lesk	34,6 x 11,4 cm	4 236,-/5 126,-

PŘÍSLUŠENSTVÍ SPRING

BOČNÍ SKŘÍŇKY A ZRCADLOVÉ SKŘÍŇKY



Nábytek Spring nabízíme v těchto barvách:

Dekor dřeva - CODE

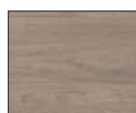

D01
Just Oak



D02
Red Wood

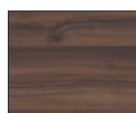

D03
Canella Brown



D04
Charred Black

Matná/Lesklá bílá lakovaná - LACK



Z01
Matná bílá lako-
vaná - LACK



R01
Lesklá bílá lako-
vaná - LACK



Obj. č.	Popis	Rozměr	Cena
F001477CODE	Dekor dřeva s rovně seříznutou hranou dvířek s možností montáže madel	35 x 35 x 168	10 740,-/12 995,-
F001478LACK	Lakovaný povrch se skosenými hranami dvířek bez možnosti montáže úchytek	35 x 35 x 168	19 898,-/24 077,-



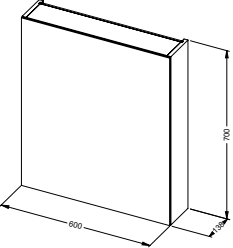
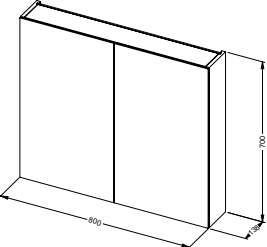
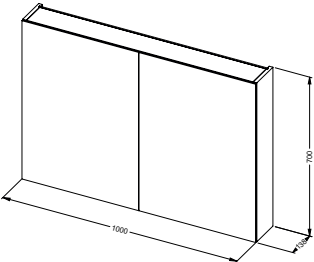
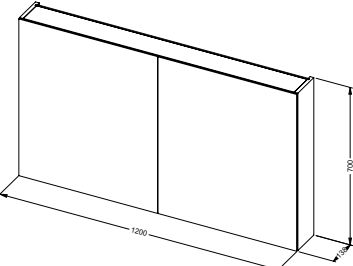























	Obj. č.	Popis	Rozměr	Cena
	F001480CODE	Dekor dřeva	60 x 13,8 x 70	11 325,-/13 703,-
	F001480LACK	lakovaný povrch	60 x 13,8 x 70	11 325,-/13 703,-
	F001481CODE	Dekor dřeva	80 x 13,8 x 70	15 796,-/19 113,-
	F001481LACK	lakovaný povrch	80 x 13,8 x 70	15 796,-/19 113,-
	F001482CODE	Dekor dřeva	100 x 13,8 x 70	17 077,-/20 663,-
	F001482LACK	lakovaný povrch	100 x 13,8 x 70	17 077,-/20 663,-
	F001483CODE	Dekor dřeva	120 x 13,8 x 70	18 841,-/22 798,-
	F001483LACK	lakovaný povrch	120 x 13,8 x 70	18 841,-/22 798,-

NÁBYTEK

ÚCHYTKY

RIHO

	Popis	Obj. č.	Cena		Popis	Obj. č.	Cena
	Úchytka 15 cm chrom	203226	394,-/477,-		Úchytka 75 cm černá	203240	764,-/924,-
	Úchytka 40 cm chrom	203231	899,-/1 088,-		Úchytka 90 cm černá	203247	854,-/1 033,-
	Úchytka 60 cm chrom	203236	1 146,-/1 387,-		Úchytka 15 cm zlatá	203227	225,-/272,-
	Úchytka 75 cm chrom	203241	1 214,-/1 469,-		Úchytka 40 cm zlatá	203232	394,-/477,-
	Úchytka 90 cm chrom	203245	1 831,-/2 216,-		Úchytka 60 cm zlatá	203237	495,-/599,-
	Úchytka 15 cm bílá	203229	225,-/272,-		Úchytka 75 cm zlatá	203242	584,-/707,-
	Úchytka 40 cm bílá	203234	394,-/477,-		Úchytka 90 cm zlatá	203248	652,-/789,-
	Úchytka 60 cm bílá	203239	495,-/599,-		Úchytka 15 cm matná stříbrná	203228	303,-/367,-
	Úchytka 75 cm bílá	203244	584,-/707,-		Úchytka 40 cm matná stříbrná	203233	471,-/570,-
	Úchytka 90 cm bílá	203246	652,-/789,-		Úchytka 60 cm matná stříbrná	203238	607,-/734,-
	Úchytka 15 cm černá	203225	337,-/408,-		Úchytka 75 cm matná stříbrná	203243	696,-/842,-
	Úchytka 40 cm černá	203230	517,-/626,-		Úchytka 90 cm matná stříbrná	203249	764,-/924,-
	Úchytka 60 cm černá	203235	663,-/802,-				

OSVĚTLENÍ ZRCADEL

Popis	Obj. č.	Cena
 <p>Osvětlení Typ 09 chrom 30 cm</p>	204930	1 809,-/2 189,-
 <p>Osvětlení Typ 09 černá 30 cm</p>	204929	1 809,-/2 189,-

ELEKTRICKÁ ZÁSUVKA S VYPÍNAČEM

Popis	Obj. č.	Cena
 <p>(IP20 RAND-CZ)</p>	202413	1 146,-/1 387,-
 <p>(IP20 PEN)</p>	202412	1 146,-/1 387,-
 <p>(IP20 CH)</p>	202411	1 146,-/1 387,-





INDUSTRIÁLNÍ ČERNÁ A MINIMALISTICKÁ BÍLÁ

Stylová kvalitní koupelna s jedinečnými průmyslovými detaily: To je Livit. Kolekce nábytku Livit je založena na výběru z designových umyvadel, která lze kombinovat se spodními skříňkami a buddy rámy. Základní prvky mají elegantní, tenké čela zásuvek, a tenká čela dvířek, která jsou k dispozici s bílými i černými detaily.

Dřevěné dekory byly pečlivě vybrány tak, aby dokonale ladily s černobílými doplňky.

Kromě již sestavených setů vám jako v loňském roce nabízíme možnost vytvořit si vlastní kombinaci koupelnového nábytku. Všechny jednotlivé prvky a příslušenství najdete v příslušných kapitolách.

S touto kolekcí si můžete vytvořit prostor podle svých představ s dlouhodobou užitnou hodnotou.

Barvy Livit.....	str. 316
Objednací metoda Livit.....	str. 317
Livit In between.....	str. 318
Mramorové dekory dřeva.....	str. 319
Základní sety Glaze Top.....	str. 320
Základní sety Velvet Slim.....	str. 334
Základní sety Velvet Top.....	str. 342
Základní sety Stone Slim.....	str. 354
Základní sety Livit Stone Top.....	str. 362
Umyvadla s mramorovým povrchem.....	str. 372
Livit umyvadlo Tiny.....	str. 378
Kombinovatelné prvky Livit.....	str. 383
Příslušenství Livit.....	str. 399

LIVIT BARVY NÁBYTKU

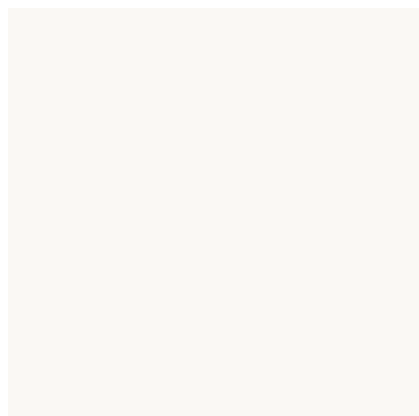

ZM1 - Frosted



DIN - Copper



DRO - Smoke



DRE - Café aje lait

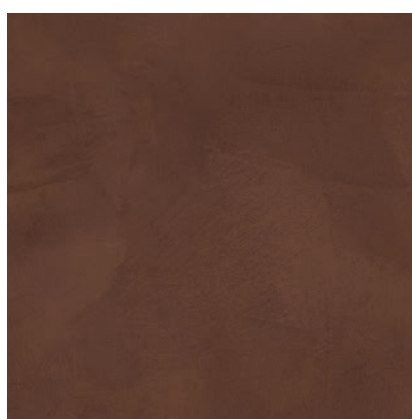

DLB - Corten

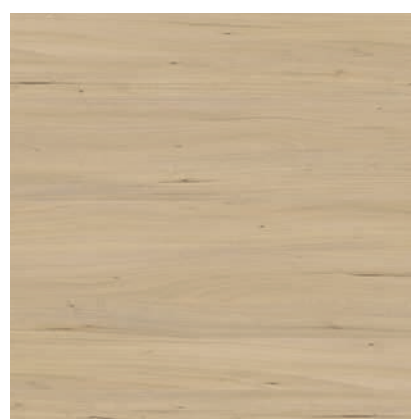

DLL - Larson



DMB - Mahogany

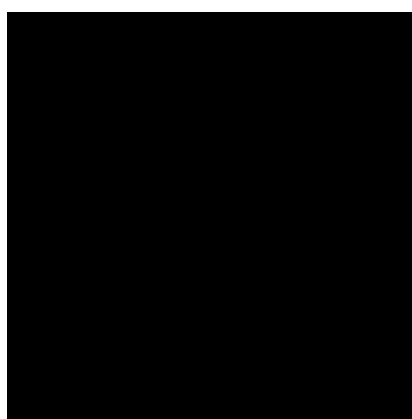

DW6 - Pitch Black



X00 - Marble white + Mahogany



X01 - Marble black + Mahogany

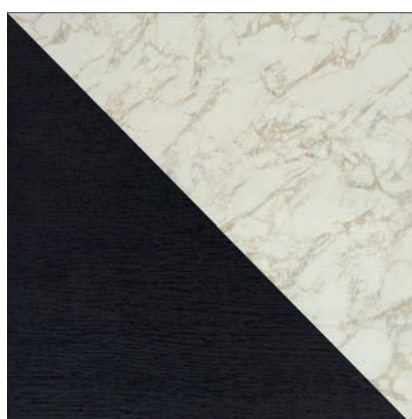

X02 - Marble white + Pitch Black

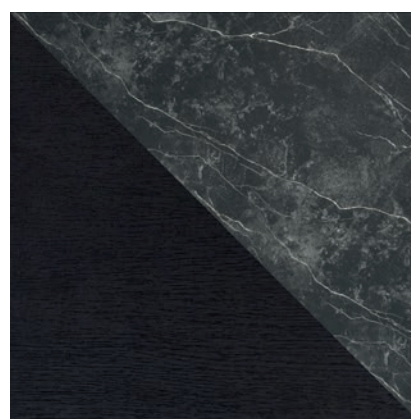

X03 - Marble black + Pitch Black

OBJEDNACÍ METODA LIVIT

1. Vyberte si typ umyvadla

- Glaze Top: Keramika
- Velvet Slim: Solid Surface
- Velvet Top: Solid Surface
- Stone Slim: Pryskyřice
- Stone Top: Pryskyřice
- Umyvadla s mramorovým povrchem: Keramika



Glaze Top



Velvet Slim



Velvet Top



Stone Slim



Stone Top



Umyvadla s mramorovým povrchem

2. Vyberte si z námi nabízených setů. Ty se liší výběrem umyvadla

- Můžete si vybrat umyvadlo v kombinaci se spodní skříňkou s jednou nebo dvěma zásuvkami nebo s buddy rámem a krycími deskami. V závislosti na typu umyvadla nabízíme také sady s volně závěšeným umyvadlem.

3. Vyberte si délku nábytku

- Délky nábytku nabízíme 60 cm, 80 cm, 100 cm, 120 cm a 140 cm

4. Zvolte si potřebný počet otvorů na baterie

- Máte možnost výběru umyvadla bez otvoru na baterie nebo s jedním nebo dvěma otvory na baterie

5. Pro objednání SETU nábytku slouží jen jedno objednáací číslo. Nábytkový Set je dodáván s chromovým clic-clackem

Chcete si sestavit svoji vlastní sadu nábytku Livit? I to je možné! Všechny jednotlivé prvky a doplňky naší kolekce Livit najdete na straně 317.

LIVIT IN BETWEEN



Kromě našich stávajících spodních skříněk s jednou nebo dvěma zásuvkami jsme v roce 2022 přidali do sekce koupelnového nábytku Livit "in betwen" - nový nábytkový díl. Tvoří ho polička, která svým prostorem odpovídá 1/2 zásuvky a tak do ní dokonale zapadá. Je vhodná pro spodní skřínky s jednou i dvěma zásuvkami. Je to nábytkový díl, kterým jsme pro vás vytvořili další prostor, do kterého si můžete uložit malé předměty. V ceníku je vnitřní zásuvka je reprezentován tímto symbolem:

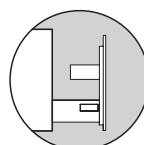



UMYVADLA S MRAMOROVÝM POVRCHEM

Objevte naše zbrusu nová keramická umyvadla v krásném mramorovém vzhledu. V kombinaci s našimi novými stylovými dekory spodních skříněk si tak můžete vytvořit individuální kousek nábytku do vaší koupelny. Umyvadla jsou k dispozici ve světlém nebo tmavém mramorovém provedení. Obě barevné varianty jsou dostupné ve 3 různých provedeních.



MRAMOROVÉ DEKORY DŘEVA

Linii mramorových umyvadel rozšiřujeme také o mramorové dekory koupelňového nábytku. Dřevěné dekory nyní můžete kombinovat s novým světlým nebo tmavým mramorováním. Dopřejte své koupelně luxusní nádech pomocí jejího vybavení těmito krásnými mramorovými prvky.



LIVIT GLAZE TOP

MODERNÍ KLASIKA

Robustní, elegantní, okouzující. To jsou keramická glazurovaná umyvadla. Minimalistické, moderní, venkovského či průmyslového stylu s charakteristickou atmosférou. Bez ohledu na styl, který si vyberete, dodají tato umyvadla vaší koupelně unikátní atmosféru. To je kouzlo keramiky. Zavěste keramické umyvadlo pro prostorový efekt a moderní vzhled jednoduše přímo na stěnu. Nebo použijte se spodními skříňkami s úložným prostorem tak, aby vše vyhovovalo vašim potřebám.

Materiál:

Keramika, klasika v koupelně. Kvalitní, odolná proti poškrábání, se snadnou údržbou. Vynikající volba s dlouhodobými užitnými vlastnostmi.

LIVIT GLAZE TOP

- Keramické umyvadlo
- lesklé bílé nebo matné černé provedení
- Může být zavěšeno volně na stěně
- Výška umyvadla: 12,5 cm
- Hloubka umyvadla: 9,5 cm
- Otvory pro baterie:
- pro rozměr 60, 80 cm - bez otvoru nebo 1 otvor
- rozměr 100 cm - bez otvoru, 1 nebo 2 otvory
- 120 cm - bez otvoru nebo 2 otvory
- 120 cm s k dispozici s 1 velkým umyvadlem nebo 2 menšími umyvadly
- Prostor v zásuvce není omezen
- Můžete si objednat černý nebo bílý CLIC-CLAC

Všechny koupelnové nábytky z řady Livit jsou nabízeny v těchto barevných odstínech:

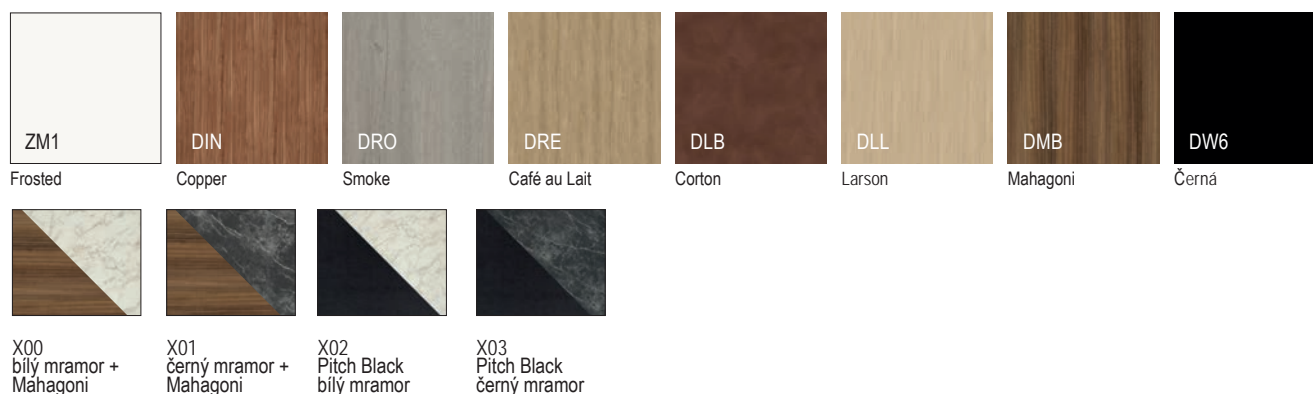

Keramické umyvadlo v bílé barvě s vysokým leskem

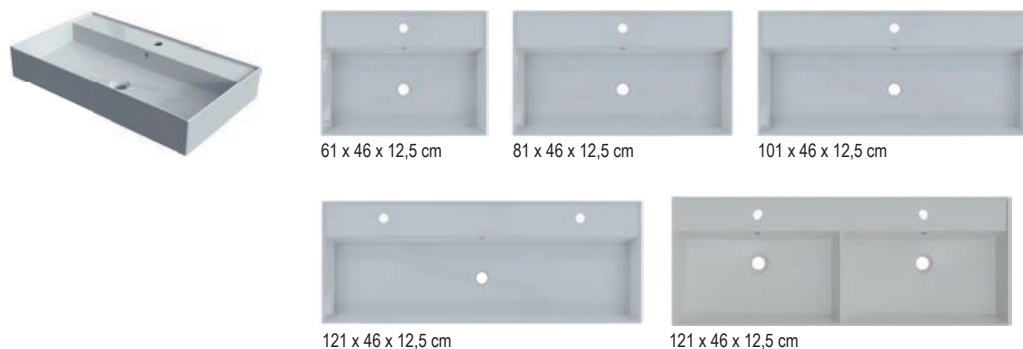

Keramické umyvadlo v černé matné barvě

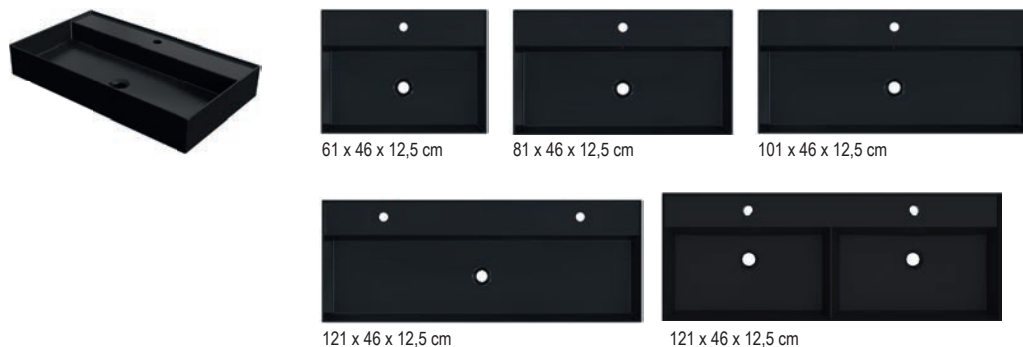

Sety nábytku s umyvadly Livit Glaze Top

Set A



A-1

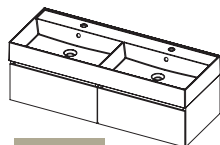

A-2

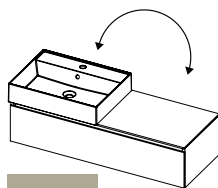

A-3

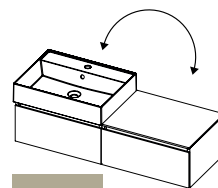

A-3

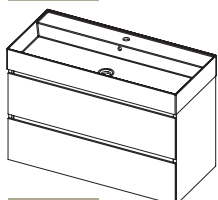

A-4

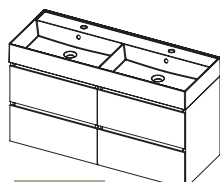

A-5

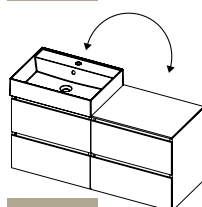

A-6

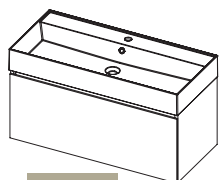

A-7

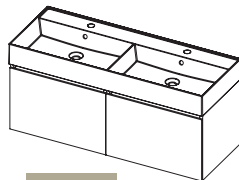

A-8

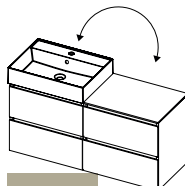

A-9

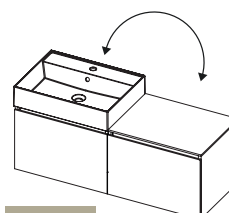

A-9

Set B

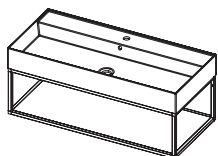

B-1

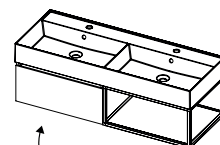

B-2

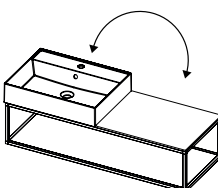

B-3

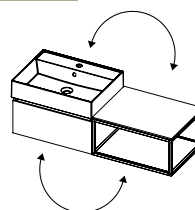

B-4

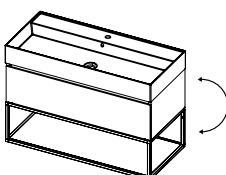

B-5

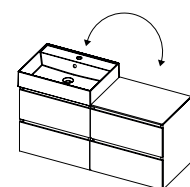

B-6

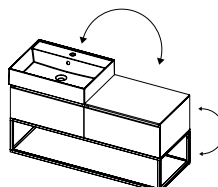

B-7

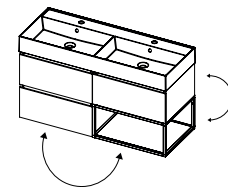

B-8

Set C

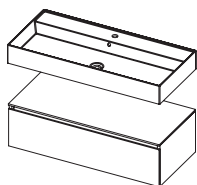

C-1

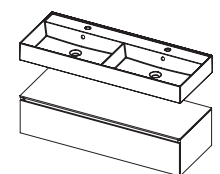

C-2

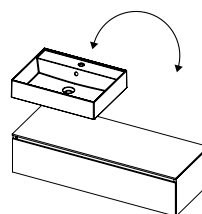

C-3

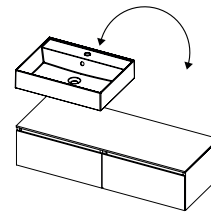

C-3

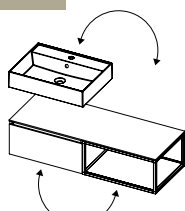

C-4

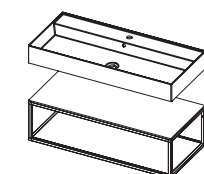

C-5

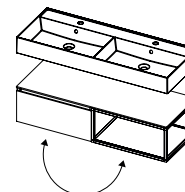

C-6

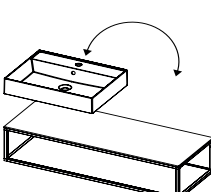

C-7

A-1

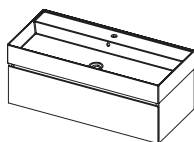

Rozměr nábytku (d x h x v)	Rozměr umyvadla (d x h x v)	Počet otvorů na baterie	Umístění umyvadla	Barva umyvadla	Umístění výřezu v zásuvce na sifon	Obj. č. nábytku bezú- chytková černá	Cena
60 x 45,5 x 28	61 x 46 x 12,5	0		<input type="checkbox"/>	<input type="checkbox"/>	F002032CODE	23 684,-/28 658,-
60 x 45,5 x 28	61 x 46 x 12,5	0		<input checked="" type="checkbox"/>	<input type="checkbox"/>	F002038CODE	27 267,-/32 993,-
60 x 45,5 x 28	61 x 46 x 12,5	1		<input type="checkbox"/>	<input type="checkbox"/>	F002021CODE	23 223,-/28 100,-
60 x 45,5 x 28	61 x 46 x 12,5	1		<input checked="" type="checkbox"/>	<input type="checkbox"/>	F002042CODE	26 178,-/31 675,-
80 x 45,5 x 28	81 x 46 x 12,5	0		<input type="checkbox"/>	<input type="checkbox"/>	F002046CODE	27 054,-/32 735,-
80 x 45,5 x 28	81 x 46 x 12,5	0		<input checked="" type="checkbox"/>	<input type="checkbox"/>	F002052CODE	31 458,-/38 064,-
80 x 45,5 x 28	81 x 46 x 12,5	1		<input type="checkbox"/>	<input type="checkbox"/>	F002022CODE	26 324,-/31 852,-
80 x 45,5 x 28	81 x 46 x 12,5	1		<input checked="" type="checkbox"/>	<input type="checkbox"/>	F002056CODE	30 267,-/36 623,-
100 x 45,5 x 28	101 x 46 x 12,5	0		<input type="checkbox"/>	<input type="checkbox"/>	F002060CODE	30 559,-/36 976,-
100 x 45,5 x 28	101 x 46 x 12,5	0		<input checked="" type="checkbox"/>	<input type="checkbox"/>	F002068CODE	35 818,-/43 340,-
100 x 45,5 x 28	101 x 46 x 12,5	1		<input type="checkbox"/>	<input type="checkbox"/>	F002023CODE	29 706,-/35 944,-
100 x 45,5 x 28	101 x 46 x 12,5	1		<input checked="" type="checkbox"/>	<input type="checkbox"/>	F002072CODE	34 615,-/41 884,-
100 x 45,5 x 28	101 x 46 x 12,5	2		<input type="checkbox"/>	<input type="checkbox"/>	F002024CODE	30 908,-/37 399,-
100 x 45,5 x 28	101 x 46 x 12,5	2		<input checked="" type="checkbox"/>	<input type="checkbox"/>	F002076CODE	35 818,-/43 340,-
120 x 45,5 x 28	121 x 46 x 12,5	0		<input type="checkbox"/>	<input type="checkbox"/>	F002080CODE	36 536,-/44 209,-
120 x 45,5 x 28	121 x 46 x 12,5	0		<input checked="" type="checkbox"/>	<input type="checkbox"/>	F002086CODE	43 221,-/52 297,-
120 x 45,5 x 28	121 x 46 x 12,5	2		<input type="checkbox"/>	<input type="checkbox"/>	F002107CODE	36 536,-/44 209,-
120 x 45,5 x 28	121 x 46 x 12,5	2		<input checked="" type="checkbox"/>	<input type="checkbox"/>	F002090CODE	43 221,-/52 297,-
120 x 45,5 x 28	121 x 46 x 12,5	0		<input type="checkbox"/>	<input type="checkbox"/>	F002094CODE	38 256,-/46 290,-
120 x 45,5 x 28	121 x 46 x 12,5	0		<input checked="" type="checkbox"/>	<input type="checkbox"/>	F002100CODE	45 401,-/54 935,-
120 x 45,5 x 28	121 x 46 x 12,5	2		<input type="checkbox"/>	<input type="checkbox"/>	F002025CODE	37 952,-/45 922,-
120 x 45,5 x 28	121 x 46 x 12,5	2		<input checked="" type="checkbox"/>	<input type="checkbox"/>	F002104CODE	44 210,-/53 494,-

A-2

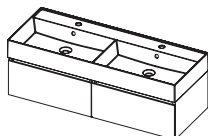

Rozměr nábytku (d x h x v)	Rozměr umyvadla (d x h x v)	Počet otvorů na baterie	Umístění umyvadla	Barva umyvadla	Umístění výřezu v zásuvce na sifon	Obj. č. nábytku be- zúchytková černá	Cena
120 x 45,5 x 28	121 x 46 x 12,5	0		<input type="checkbox"/>	<input type="checkbox"/>	F002114CODE	48 198,-/58 320,-
120 x 45,5 x 28	121 x 46 x 12,5	0		<input checked="" type="checkbox"/>	<input type="checkbox"/>	F002122CODE	55 343,-/66 965,-
120 x 45,5 x 28	121 x 46 x 12,5	2		<input type="checkbox"/>	<input type="checkbox"/>	F002118CODE	46 996,-/56 865,-
120 x 45,5 x 28	121 x 46 x 12,5	2		<input checked="" type="checkbox"/>	<input type="checkbox"/>	F002126CODE	54 153,-/65 525,-

A-3

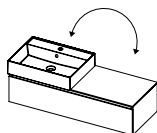

Rozměr nábytku (d x h x v)	Rozměr umyvadla (d x h x v)	Počet otvorů na baterie	Umístění umyvadla	Barva umyvadla	Umístění výřezu v zásuvce na sifon	Obj. č. nábytku be- zúchytková černá	Cena
120 x 45,5 x 28	61 x 46 x 12,5	0		<input type="checkbox"/>	<input type="checkbox"/>	F002131CODE	29 706,-/35 944,-
120 x 45,5 x 28	61 x 46 x 12,5	0		<input checked="" type="checkbox"/>	<input type="checkbox"/>	F002147CODE	33 289,-/40 280,-
120 x 45,5 x 28	61 x 46 x 12,5	1		<input type="checkbox"/>	<input type="checkbox"/>	F002139CODE	28 874,-/34 938,-
120 x 45,5 x 28	61 x 46 x 12,5	1		<input checked="" type="checkbox"/>	<input type="checkbox"/>	F002155CODE	32 222,-/38 989,-

A-3

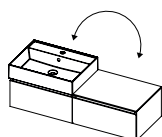

Rozměr nábytku (d x h x v)	Rozměr umyvadla (d x h x v)	Počet otvorů na baterie	Umístění umyvadla	Barva umyvadla	Umístění vyřezu v zásuvce na sifon	Obj. č. nábytku be- zúchytková černá	Cena
120 x 45,5 x 28	61 x 46 x 12,5	0		<input type="checkbox"/>	<input type="checkbox"/>	F002132CODE	38 615,-/46 724,-
120 x 45,5 x 28	61 x 46 x 12,5	0		<input checked="" type="checkbox"/>	<input type="checkbox"/>	F002148CODE	42 188,-/51 047,-
120 x 45,5 x 28	61 x 46 x 12,5	1		<input type="checkbox"/>	<input type="checkbox"/>	F002140CODE	37 772,-/45 704,-
120 x 45,5 x 28	61 x 46 x 12,5	1		<input checked="" type="checkbox"/>	<input type="checkbox"/>	F002156CODE	41 109,-/49 742,-
160 x 45,5 x 28	81 x 46 x 12,5	0		<input type="checkbox"/>	<input type="checkbox"/>	F002162CODE	42 996,-/52 025,-
160 x 45,5 x 28	81 x 46 x 12,5	0		<input checked="" type="checkbox"/>	<input type="checkbox"/>	F002170CODE	47 412,-/57 369,-
160 x 45,5 x 28	81 x 46 x 12,5	1		<input type="checkbox"/>	<input type="checkbox"/>	F002166CODE	41 929,-/50 734,-
160 x 45,5 x 28	81 x 46 x 12,5	1		<input checked="" type="checkbox"/>	<input type="checkbox"/>	F002174CODE	46 221,-/55 927,-

A-4

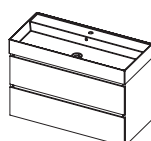

Rozměr nábytku (d x h x v)	Rozměr umyvadla (d x h x v)	Počet otvorů na baterie	Umístění umyvadla	Barva umyvadla	Umístění vyřezu v zásuvce na sifon	Obj. č. nábytku be- zúchytková černá	Cena
60 x 45,5 x 56	61 x 46 x 12,5	0		<input type="checkbox"/>	<input type="checkbox"/>	F002178CODE	29 380,-/35 550,-
60 x 45,5 x 56	61 x 46 x 12,5	0		<input checked="" type="checkbox"/>	<input type="checkbox"/>	F002184CODE	32 952,-/39 872,-
60 x 45,5 x 56	61 x 46 x 12,5	1		<input type="checkbox"/>	<input type="checkbox"/>	F002001CODE	28 886,-/34 952,-
60 x 45,5 x 56	61 x 46 x 12,5	1		<input checked="" type="checkbox"/>	<input type="checkbox"/>	F002188CODE	31 885,-/38 581,-
80 x 45,5 x 56	81 x 46 x 12,5	0		<input type="checkbox"/>	<input type="checkbox"/>	F002192CODE	33 368,-/40 375,-
80 x 45,5 x 56	81 x 46 x 12,5	0		<input checked="" type="checkbox"/>	<input type="checkbox"/>	F002198CODE	37 783,-/45 717,-
80 x 45,5 x 56	81 x 46 x 12,5	1		<input type="checkbox"/>	<input type="checkbox"/>	F002002CODE	32 638,-/39 492,-
80 x 45,5 x 56	81 x 46 x 12,5	1		<input checked="" type="checkbox"/>	<input type="checkbox"/>	F002202CODE	36 593,-/44 278,-
100 x 45,5 x 56	101 x 46 x 12,5	0		<input type="checkbox"/>	<input type="checkbox"/>	F002206CODE	37 379,-/45 229,-
100 x 45,5 x 56	101 x 46 x 12,5	0		<input checked="" type="checkbox"/>	<input type="checkbox"/>	F002214CODE	42 626,-/51 577,-
100 x 45,5 x 56	101 x 46 x 12,5	1		<input type="checkbox"/>	<input type="checkbox"/>	F002003CODE	36 536,-/44 209,-
100 x 45,5 x 56	101 x 46 x 12,5	1		<input checked="" type="checkbox"/>	<input type="checkbox"/>	F002218CODE	41 424,-/50 123,-
100 x 45,5 x 56	101 x 46 x 12,5	2		<input type="checkbox"/>	<input type="checkbox"/>	F002004CODE	37 728,-/45 651,-
100 x 45,5 x 56	101 x 46 x 12,5	2		<input checked="" type="checkbox"/>	<input type="checkbox"/>	F002222CODE	42 626,-/51 577,-
120 x 45,5 x 56	121 x 46 x 12,5	0		<input type="checkbox"/>	<input type="checkbox"/>	F002226CODE	43 996,-/53 235,-
120 x 45,5 x 56	121 x 46 x 12,5	0		<input checked="" type="checkbox"/>	<input type="checkbox"/>	F002232CODE	50 681,-/61 324,-
120 x 45,5 x 56	121 x 46 x 12,5	2		<input type="checkbox"/>	<input type="checkbox"/>	F002109CODE	43 996,-/53 235,-
120 x 45,5 x 56	121 x 46 x 12,5	2		<input checked="" type="checkbox"/>	<input type="checkbox"/>	F002236CODE	50 681,-/61 324,-
120 x 45,5 x 56	121 x 46 x 12,5	0		<input type="checkbox"/>	<input type="checkbox"/>	F002240CODE	45 715,-/55 315,-
120 x 45,5 x 56	121 x 46 x 12,5	0		<input checked="" type="checkbox"/>	<input type="checkbox"/>	F002246CODE	52 872,-/63 975,-
120 x 45,5 x 56	121 x 46 x 12,5	2		<input type="checkbox"/>	<input type="checkbox"/>	F002005CODE	45 334,-/54 854,-
120 x 45,5 x 56	121 x 46 x 12,5	2		<input checked="" type="checkbox"/>	<input type="checkbox"/>	F002250CODE	51 681,-/62 534,-

A-5

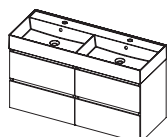

Rozměr nábytku (d x h x v)	Rozměr umyvadla (d x h x v)	Počet otvorů na baterie	Umístění umyvadla	Barva umyvadla	Umístění vyřezu v zásuvce na sifon	Obj. č. nábytku be- zúchytková černá	Cena
120 x 45,5 x 56	121 x 46 x 12,5	0		<input type="checkbox"/>	<input type="checkbox"/>	F002254CODE	59 579,-/72 091,-
120 x 45,5 x 56	121 x 46 x 12,5	0		<input checked="" type="checkbox"/>	<input type="checkbox"/>	F002262CODE	66 747,-/80 764,-
120 x 45,5 x 56	121 x 46 x 12,5	2		<input type="checkbox"/>	<input type="checkbox"/>	F002258CODE	58 388,-/70 649,-
120 x 45,5 x 56	121 x 46 x 12,5	2		<input checked="" type="checkbox"/>	<input type="checkbox"/>	F002266CODE	65 545,-/79 309,-

A-6

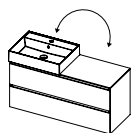

Rozměr nábytku (d x h x v)	Rozměr umyvadla (d x h x v)	Počet otvorů na baterie	Umístění umyvadla	Barva umyvadla	Umístění výřezu v zásuvce na sifon	Obj. č. nábytku bezúchytková černá	Cena
120 x 45,5 x 56	61 x 46 x 12,5	0	<input type="checkbox"/>	<input type="checkbox"/>	<input type="checkbox"/>	F002271CODE	37 166,-/44 971,-
120 x 45,5 x 56	61 x 46 x 12,5	0	<input type="checkbox"/>	<input checked="" type="checkbox"/>	<input type="checkbox"/>	F002287CODE	40 749,-/49 306,-
120 x 45,5 x 56	61 x 46 x 12,5	1	<input type="checkbox"/>	<input type="checkbox"/>	<input type="checkbox"/>	F002279CODE	36 346,-/43 979,-
120 x 45,5 x 56	61 x 46 x 12,5	1	<input type="checkbox"/>	<input checked="" type="checkbox"/>	<input type="checkbox"/>	F002295CODE	39 682,-/48 015,-

A-6

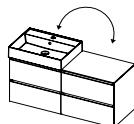

Rozměr nábytku (d x h x v)	Rozměr umyvadla (d x h x v)	Počet otvorů na baterie	Umístění umyvadla	Barva umyvadla	Umístění výřezu v zásuvce na sifon	Obj. č. nábytku bezúchytková černá	Cena
120 x 45,5 x 56	61 x 46 x 12,5	0	<input type="checkbox"/>	<input type="checkbox"/>	<input type="checkbox"/>	F002272CODE	49 996,-/60 495,-
120 x 45,5 x 56	61 x 46 x 12,5	0	<input type="checkbox"/>	<input checked="" type="checkbox"/>	<input type="checkbox"/>	F002288CODE	53 579,-/64 831,-
120 x 45,5 x 56	61 x 46 x 12,5	1	<input type="checkbox"/>	<input type="checkbox"/>	<input type="checkbox"/>	F002280CODE	49 164,-/59 488,-
120 x 45,5 x 56	61 x 46 x 12,5	1	<input type="checkbox"/>	<input checked="" type="checkbox"/>	<input type="checkbox"/>	F002296CODE	52 513,-/63 541,-
160 x 45,5 x 56	81 x 46 x 12,5	1	<input type="checkbox"/>	<input type="checkbox"/>	<input type="checkbox"/>	F002306CODE	54 569,-/66 028,-
160 x 45,5 x 56	81 x 46 x 12,5	1	<input type="checkbox"/>	<input checked="" type="checkbox"/>	<input type="checkbox"/>	F002314CODE	58 860,-/71 221,-
160 x 45,5 x 56	81 x 46 x 12,5	0	<input type="checkbox"/>	<input type="checkbox"/>	<input type="checkbox"/>	F002302CODE	55 635,-/67 318,-
160 x 45,5 x 56	81 x 46 x 12,5	0	<input type="checkbox"/>	<input checked="" type="checkbox"/>	<input type="checkbox"/>	F002310CODE	60 062,-/72 675,-

A-7

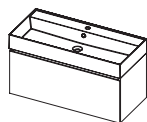

Rozměr nábytku (d x h x v)	Rozměr umyvadla (d x h x v)	Počet otvorů na baterie	Umístění umyvadla	Barva umyvadla	Umístění výřezu v zásuvce na sifon	Obj. č. nábytku bezúchytková černá	Cena
60 x 45,5 x 42	61 x 46 x 12,5	0	<input type="checkbox"/>	<input type="checkbox"/>	<input type="checkbox"/>	F002839CODE	23 380,-/28 290,-
60 x 45,5 x 42	61 x 46 x 12,5	1	<input type="checkbox"/>	<input type="checkbox"/>	<input type="checkbox"/>	F002840CODE	23 380,-/28 290,-
80 x 45,5 x 42	81 x 46 x 12,5	0	<input type="checkbox"/>	<input type="checkbox"/>	<input type="checkbox"/>	F002841CODE	27 088,-/32 776,-
80 x 45,5 x 42	81 x 46 x 12,5	1	<input type="checkbox"/>	<input type="checkbox"/>	<input type="checkbox"/>	F002842CODE	27 088,-/32 776,-
100 x 45,5 x 42	101 x 46 x 12,5	0	<input type="checkbox"/>	<input type="checkbox"/>	<input type="checkbox"/>	F002843CODE	30 357,-/36 732,-
100 x 45,5 x 42	101 x 46 x 12,5	1	<input type="checkbox"/>	<input type="checkbox"/>	<input type="checkbox"/>	F002844CODE	30 357,-/36 732,-
100 x 45,5 x 42	101 x 46 x 12,5	2	<input type="checkbox"/>	<input type="checkbox"/>	<input type="checkbox"/>	F002845CODE	30 357,-/36 732,-
120 x 45,5 x 42	121 x 46 x 12,5	0	<input type="checkbox"/>	<input type="checkbox"/>	<input type="checkbox"/>	F002846CODE	35 199,-/42 591,-
120 x 45,5 x 42	121 x 46 x 12,5	2	<input type="checkbox"/>	<input type="checkbox"/>	<input type="checkbox"/>	F002847CODE	35 199,-/42 591,-
120 x 45,5 x 42	121 x 46 x 12,5	0	<input checked="" type="checkbox"/>	<input type="checkbox"/>	<input type="checkbox"/>	F002848CODE	37 064,-/44 847,-
120 x 45,5 x 42	121 x 46 x 12,5	2	<input checked="" type="checkbox"/>	<input type="checkbox"/>	<input type="checkbox"/>	F002849CODE	37 064,-/44 847,-
60 x 45,5 x 42	61 x 46 x 12,5	0	<input type="checkbox"/>	<input checked="" type="checkbox"/>	<input type="checkbox"/>	F002858CODE	27 155,-/32 858,-
60 x 45,5 x 42	61 x 46 x 12,5	1	<input type="checkbox"/>	<input checked="" type="checkbox"/>	<input type="checkbox"/>	F002859CODE	27 155,-/32 858,-
80 x 45,5 x 42	81 x 46 x 12,5	0	<input type="checkbox"/>	<input checked="" type="checkbox"/>	<input type="checkbox"/>	F002860CODE	27 021,-/32 695,-
80 x 45,5 x 42	81 x 46 x 12,5	1	<input type="checkbox"/>	<input checked="" type="checkbox"/>	<input type="checkbox"/>	F002861CODE	27 021,-/32 695,-
100 x 45,5 x 42	101 x 46 x 12,5	0	<input type="checkbox"/>	<input checked="" type="checkbox"/>	<input type="checkbox"/>	F002862CODE	35 402,-/42 836,-
100 x 45,5 x 42	101 x 46 x 12,5	1	<input type="checkbox"/>	<input checked="" type="checkbox"/>	<input type="checkbox"/>	F002863CODE	35 402,-/42 836,-
100 x 45,5 x 42	101 x 46 x 12,5	2	<input type="checkbox"/>	<input checked="" type="checkbox"/>	<input type="checkbox"/>	F002864CODE	35 402,-/42 836,-
120 x 45,5 x 42	121 x 46 x 12,5	0	<input type="checkbox"/>	<input checked="" type="checkbox"/>	<input type="checkbox"/>	F002865CODE	43 030,-/52 066,-
120 x 45,5 x 42	121 x 46 x 12,5	2	<input type="checkbox"/>	<input checked="" type="checkbox"/>	<input type="checkbox"/>	F002866CODE	43 030,-/52 066,-
120 x 45,5 x 42	121 x 46 x 12,5	0	<input checked="" type="checkbox"/>	<input checked="" type="checkbox"/>	<input type="checkbox"/>	F002867CODE	44 435,-/53 766,-
120 x 45,5 x 42	121 x 46 x 12,5	2	<input checked="" type="checkbox"/>	<input checked="" type="checkbox"/>	<input type="checkbox"/>	F002868CODE	44 435,-/53 766,-

A-8

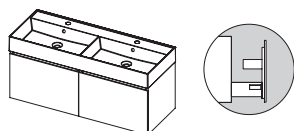

Rozměr nábytku (d x h x v)	Rozměr umyvadla (d x h x v)	Počet otvorů na baterie	Umístění umyvadla	Barva umyvadla	Umístění vyřezu v zásuvce na sifon	Obj. č. nábytku be- zúchytková černá	Cena
120 x 45,5 x 42	121 x 46 x 12,5	0		<input type="checkbox"/>	<input type="checkbox"/>	F002850CODE	46 828,-/56 662,-
120 x 45,5 x 42	121 x 46 x 12,5	2		<input type="checkbox"/>	<input type="checkbox"/>	F002851CODE	46 828,-/56 662,-
120 x 45,5 x 42	121 x 46 x 12,5	0		<input checked="" type="checkbox"/>	<input type="checkbox"/>	F002869CODE	54 198,-/65 580,-
120 x 45,5 x 42	121 x 46 x 12,5	2		<input checked="" type="checkbox"/>	<input type="checkbox"/>	F002870CODE	54 198,-/65 580,-

A-9

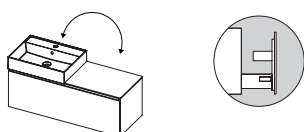

Rozměr nábytku (d x h x v)	Rozměr umyvadla (d x h x v)	Počet otvorů na baterie	Umístění umyvadla	Barva umyvadla	Umístění vyřezu v zásuvce na sifon	Obj. č. nábytku be- zúchytková černá	Cena
120 x 45,5 x 42	61 x 46 x 12,5	0		<input type="checkbox"/>	<input type="checkbox"/>	F002852CODE	28 099,-/34 000,-
120 x 45,5 x 42	61 x 46 x 12,5	1		<input type="checkbox"/>	<input type="checkbox"/>	F002853CODE	28 099,-/34 000,-
120 x 45,5 x 42	61 x 46 x 12,5	0		<input checked="" type="checkbox"/>	<input type="checkbox"/>	F002871CODE	28 099,-/34 000,-
120 x 45,5 x 42	61 x 46 x 12,5	1		<input checked="" type="checkbox"/>	<input type="checkbox"/>	F002872CODE	28 099,-/34 000,-

A-9

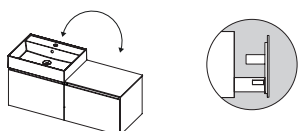

Rozměr nábytku (d x h x v)	Rozměr umyvadla (d x h x v)	Počet otvorů na baterie	Umístění umyvadla	Barva umyvadla	Umístění vyřezu v zásuvce na sifon	Obj. č. nábytku be- zúchytková černá	Cena
120 x 45,5 x 42	61 x 46 x 12,5	0		<input type="checkbox"/>	<input type="checkbox"/>	F002854CODE	37 874,-/45 828,-
120 x 45,5 x 42	61 x 46 x 12,5	1		<input type="checkbox"/>	<input type="checkbox"/>	F002855CODE	37 874,-/45 828,-
120 x 45,5 x 42	61 x 46 x 12,5	0		<input checked="" type="checkbox"/>	<input type="checkbox"/>	F002873CODE	37 874,-/45 828,-
120 x 45,5 x 42	61 x 46 x 12,5	1		<input checked="" type="checkbox"/>	<input type="checkbox"/>	F002874CODE	37 874,-/45 828,-
160 x 45,5 x 42	81 x 46 x 12,5	0		<input type="checkbox"/>	<input type="checkbox"/>	F002856CODE	42 896,-/51 904,-
160 x 45,5 x 42	81 x 46 x 12,5	1		<input type="checkbox"/>	<input type="checkbox"/>	F002857CODE	42 896,-/51 904,-
160 x 45,5 x 42	81 x 46 x 12,5	0		<input checked="" type="checkbox"/>	<input type="checkbox"/>	F002875CODE	42 896,-/51 904,-
160 x 45,5 x 42	81 x 46 x 12,5	1		<input checked="" type="checkbox"/>	<input type="checkbox"/>	F002876CODE	42 896,-/51 904,-

B-1

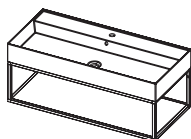

Rozměr nábytku (d x h x v)	Rozměr umyvadla (d x h x v)	Počet otvorů na baterie	Umístění umyvadla	Barva umyvadla	Umístění výřezu v zásuvce na sifon	Rám Buddy černá	Cena
60 x 45,5 x 28	61 x 46 x 12,5	0		<input type="checkbox"/>	<input type="checkbox"/>	F002318CODE	20 718,-/25 069,-
60 x 45,5 x 28	61 x 46 x 12,5	0		<input checked="" type="checkbox"/>	<input type="checkbox"/>	F002322CODE	24 290,-/29 391,-
60 x 45,5 x 28	61 x 46 x 12,5	1		<input type="checkbox"/>	<input type="checkbox"/>	F002320CODE	19 459,-/23 545,-
60 x 45,5 x 28	61 x 46 x 12,5	1		<input checked="" type="checkbox"/>	<input type="checkbox"/>	F002324CODE	22 807,-/27 596,-
80 x 45,5 x 28	81 x 46 x 12,5	0		<input type="checkbox"/>	<input type="checkbox"/>	F002326CODE	23 830,-/28 834,-
80 x 45,5 x 28	81 x 46 x 12,5	0		<input checked="" type="checkbox"/>	<input type="checkbox"/>	F002330CODE	28 233,-/34 162,-
80 x 45,5 x 28	81 x 46 x 12,5	1		<input type="checkbox"/>	<input type="checkbox"/>	F002328CODE	22 673,-/27 434,-
80 x 45,5 x 28	81 x 46 x 12,5	1		<input checked="" type="checkbox"/>	<input type="checkbox"/>	F002332CODE	26 976,-/32 641,-
100 x 45,5 x 28	101 x 46 x 12,5	0		<input type="checkbox"/>	<input type="checkbox"/>	F002334CODE	26 919,-/32 572,-
100 x 45,5 x 28	101 x 46 x 12,5	0		<input checked="" type="checkbox"/>	<input type="checkbox"/>	F002340CODE	32 166,-/38 921,-
100 x 45,5 x 28	101 x 46 x 12,5	1		<input type="checkbox"/>	<input type="checkbox"/>	F002336CODE	26 065,-/31 539,-
100 x 45,5 x 28	101 x 46 x 12,5	1		<input checked="" type="checkbox"/>	<input type="checkbox"/>	F002342CODE	31 312,-/37 888,-
100 x 45,5 x 28	101 x 46 x 12,5	2		<input type="checkbox"/>	<input type="checkbox"/>	F002338CODE	27 267,-/32 993,-
100 x 45,5 x 28	101 x 46 x 12,5	2		<input checked="" type="checkbox"/>	<input type="checkbox"/>	F002344CODE	32 503,-/39 329,-
120 x 45,5 x 28	121 x 46 x 12,5	0		<input type="checkbox"/>	<input type="checkbox"/>	F002346CODE	32 244,-/39 015,-
120 x 45,5 x 28	121 x 46 x 12,5	0		<input checked="" type="checkbox"/>	<input type="checkbox"/>	F002350CODE	38 918,-/47 091,-
120 x 45,5 x 28	121 x 46 x 12,5	2		<input type="checkbox"/>	<input type="checkbox"/>	F002348CODE	32 638,-/39 492,-
120 x 45,5 x 28	121 x 46 x 12,5	2		<input checked="" type="checkbox"/>	<input type="checkbox"/>	F002352CODE	39 311,-/47 566,-
120 x 45,5 x 28	121 x 46 x 12,5	0		<input type="checkbox"/>	<input type="checkbox"/>	F002354CODE	33 952,-/41 082,-
120 x 45,5 x 28	121 x 46 x 12,5	0		<input checked="" type="checkbox"/>	<input type="checkbox"/>	F002358CODE	41 109,-/49 742,-
120 x 45,5 x 28	121 x 46 x 12,5	2		<input type="checkbox"/>	<input type="checkbox"/>	F002356CODE	32 761,-/39 641,-
120 x 45,5 x 28	121 x 46 x 12,5	2		<input checked="" type="checkbox"/>	<input type="checkbox"/>	F002360CODE	39 918,-/48 301,-

B-2

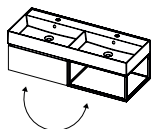

Rozměr nábytku (d x h x v)	Rozměr umyvadla (d x h x v)	Počet otvorů na baterie	Umístění umyvadla	Barva umyvadla	Umístění výřezu v zásuvce na sifon	Obj. č. nábytku bezú- hytková černá	Cena
120 x 45,5 x 28	121 x 46 x 12,5	0		<input type="checkbox"/>	<input type="checkbox"/>	F002363CODE	44 816,-/54 227,-
120 x 45,5 x 28	121 x 46 x 12,5	0		<input checked="" type="checkbox"/>	<input type="checkbox"/>	F002371CODE	51 973,-/62 887,-
120 x 45,5 x 28	121 x 46 x 12,5	2		<input type="checkbox"/>	<input type="checkbox"/>	F002367CODE	43 614,-/52 773,-
120 x 45,5 x 28	121 x 46 x 12,5	2		<input checked="" type="checkbox"/>	<input type="checkbox"/>	F002375CODE	50 782,-/61 446,-

B-3

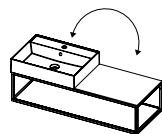

Rozměr nábytku (d x h x v)	Rozměr umyvadla (d x h x v)	Počet otvorů na baterie	Umístění umyvadla	Barva umyvadla	Umístění výřezu v zásuvce na sifon	Rám Buddy černá	Cena
120 x 45,5 x 28	61 x 46 x 12,5	0		<input type="checkbox"/>	<input type="checkbox"/>	F002378CODE	25 413,-/30 750,-
120 x 45,5 x 28	61 x 46 x 12,5	0		<input checked="" type="checkbox"/>	<input type="checkbox"/>	F002382CODE	28 998,-/35 088,-
120 x 45,5 x 28	61 x 46 x 12,5	1		<input type="checkbox"/>	<input type="checkbox"/>	F002379CODE	24 964,-/30 020,-
120 x 45,5 x 28	61 x 46 x 12,5	1		<input checked="" type="checkbox"/>	<input type="checkbox"/>	F002380CODE	28 312,-/34 258,-

B-4

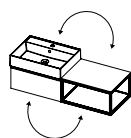

Rozměr nábytku (d x h x v)	Rozměr umyvadla (d x h x v)	Počet otvorů na baterie	Umístění umyvadla	Barva umyvadla	Umístění vyřezu v zásuvce na sifon	Obj. č. nábytku bezúchytková černá	Cena
60 x 45,5 x 28	61 x 46 x 12,5	0		<input type="checkbox"/>	<input type="checkbox"/>	F002387CODE	35 649,-/43 135,-
60 x 45,5 x 28	61 x 46 x 12,5	0		<input checked="" type="checkbox"/>	<input type="checkbox"/>	F002395CODE	39 210,-/47 444,-
60 x 45,5 x 28	61 x 46 x 12,5	1		<input type="checkbox"/>	<input type="checkbox"/>	F002391CODE	34 806,-/42 115,-
60 x 45,5 x 28	61 x 46 x 12,5	1		<input checked="" type="checkbox"/>	<input type="checkbox"/>	F002399CODE	38 143,-/46 153,-
80 x 45,5 x 28	81 x 46 x 12,5	0		<input type="checkbox"/>	<input type="checkbox"/>	F002403CODE	39 783,-/48 137,-
80 x 45,5 x 28	81 x 46 x 12,5	0		<input checked="" type="checkbox"/>	<input type="checkbox"/>	F002411CODE	44 187,-/53 466,-
80 x 45,5 x 28	81 x 46 x 12,5	1		<input type="checkbox"/>	<input type="checkbox"/>	F002407CODE	38 694,-/46 820,-
80 x 45,5 x 28	81 x 46 x 12,5	1		<input checked="" type="checkbox"/>	<input type="checkbox"/>	F002415CODE	42 996,-/52 025,-

B-5

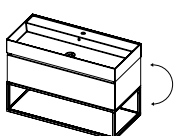

Rozměr nábytku (d x h x v)	Rozměr umyvadla (d x h x v)	Počet otvorů na baterie	Umístění umyvadla	Barva umyvadla	Umístění vyřezu v zásuvce na sifon	Obj. č. nábytku bezúchytková černá	Cena
60 x 45,5 x 56	61 x 46 x 12,5	0		<input type="checkbox"/>	<input type="checkbox"/>	F002419CODE	33 762,-/40 852,-
60 x 45,5 x 56	61 x 46 x 12,5	0		<input checked="" type="checkbox"/>	<input type="checkbox"/>	F002425CODE	37 334,-/45 174,-
60 x 45,5 x 56	61 x 46 x 12,5	1		<input type="checkbox"/>	<input type="checkbox"/>	F002011CODE	33 301,-/40 294,-
60 x 45,5 x 56	61 x 46 x 12,5	1		<input checked="" type="checkbox"/>	<input type="checkbox"/>	F002429CODE	36 255,-/43 869,-
80 x 45,5 x 56	81 x 46 x 12,5	0		<input type="checkbox"/>	<input type="checkbox"/>	F002433CODE	37 615,-/45 514,-
80 x 45,5 x 56	81 x 46 x 12,5	0		<input checked="" type="checkbox"/>	<input type="checkbox"/>	F002439CODE	42 030,-/50 856,-
80 x 45,5 x 56	81 x 46 x 12,5	1		<input type="checkbox"/>	<input type="checkbox"/>	F002012CODE	36 896,-/44 644,-
80 x 45,5 x 56	81 x 46 x 12,5	1		<input checked="" type="checkbox"/>	<input type="checkbox"/>	F002443CODE	40 840,-/49 416,-
100 x 45,5 x 56	101 x 46 x 12,5	0		<input type="checkbox"/>	<input type="checkbox"/>	F002447CODE	41 592,-/50 326,-
100 x 45,5 x 56	101 x 46 x 12,5	0		<input checked="" type="checkbox"/>	<input type="checkbox"/>	F002455CODE	46 850,-/56 689,-
100 x 45,5 x 56	101 x 46 x 12,5	1		<input type="checkbox"/>	<input type="checkbox"/>	F002013CODE	40 738,-/49 293,-
100 x 45,5 x 56	101 x 46 x 12,5	1		<input checked="" type="checkbox"/>	<input type="checkbox"/>	F002459CODE	45 648,-/55 234,-
100 x 45,5 x 56	101 x 46 x 12,5	2		<input type="checkbox"/>	<input type="checkbox"/>	F002014CODE	41 940,-/50 747,-
100 x 45,5 x 56	101 x 46 x 12,5	2		<input checked="" type="checkbox"/>	<input type="checkbox"/>	F002463CODE	46 850,-/56 689,-
120 x 45,5 x 56	121 x 46 x 12,5	0		<input type="checkbox"/>	<input type="checkbox"/>	F002467CODE	48 389,-/58 551,-
120 x 45,5 x 56	121 x 46 x 12,5	0		<input checked="" type="checkbox"/>	<input type="checkbox"/>	F002473CODE	55 074,-/66 640,-
120 x 45,5 x 56	121 x 46 x 12,5	2		<input type="checkbox"/>	<input type="checkbox"/>	F002111CODE	48 389,-/58 551,-
120 x 45,5 x 56	121 x 46 x 12,5	2		<input checked="" type="checkbox"/>	<input type="checkbox"/>	F002477CODE	55 074,-/66 640,-

B-6

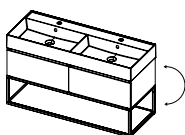

Rozměr nábytku (d x h x v)	Rozměr umyvadla (d x h x v)	Počet otvorů na baterie	Umístění umyvadla	Barva umyvadla	Umístění vyřezu v zásuvce na sifon	Obj. č. nábytku bezúchytková černá	Cena
120 x 45,5 x 56	121 x 46 x 12,5	0		<input type="checkbox"/>	<input type="checkbox"/>	F002495CODE	58 984,-/71 371,-
120 x 45,5 x 56	121 x 46 x 12,5	0		<input checked="" type="checkbox"/>	<input type="checkbox"/>	F002503CODE	66 141,-/80 031,-
120 x 45,5 x 56	121 x 46 x 12,5	2		<input type="checkbox"/>	<input type="checkbox"/>	F002499CODE	57 782,-/69 916,-
120 x 45,5 x 56	121 x 46 x 12,5	2		<input checked="" type="checkbox"/>	<input type="checkbox"/>	F002507CODE	64 950,-/78 590,-

B-7

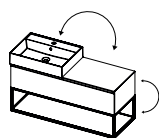

Rozměr nábytku (d x h x v)	Rozměr umyvadla (d x h x v)	Počet otvorů na baterie	Umístění umyvadla	Barva umyvadla	Umístění výřezu v zásuvce na sifon	Obj. č. nábytku bezúchytková černá	Cena
120 x 45,5 x 56	61 x 46 x 12,5	0		<input type="checkbox"/>	<input type="checkbox"/>	F002511CODE	41 558,-/50 285,-
120 x 45,5 x 56	61 x 46 x 12,5	0		<input checked="" type="checkbox"/>	<input type="checkbox"/>	F002527CODE	45 143,-/54 623,-
120 x 45,5 x 56	61 x 46 x 12,5	1		<input type="checkbox"/>	<input type="checkbox"/>	F002519CODE	40 727,-/49 280,-
120 x 45,5 x 56	61 x 46 x 12,5	1		<input checked="" type="checkbox"/>	<input type="checkbox"/>	F002535CODE	44 075,-/53 331,-

B-7

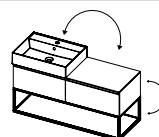

Rozměr nábytku (d x h x v)	Rozměr umyvadla (d x h x v)	Počet otvorů na baterie	Umístění umyvadla	Barva umyvadla	Umístění výřezu v zásuvce na sifon	Obj. č. nábytku bezúchytková černá	Cena
120 x 45,5 x 56	61 x 46 x 12,5	0		<input type="checkbox"/>	<input type="checkbox"/>	F002512CODE	51 973,-/62 887,-
120 x 45,5 x 56	61 x 46 x 12,5	0		<input checked="" type="checkbox"/>	<input type="checkbox"/>	F002528CODE	55 085,-/66 653,-
120 x 45,5 x 56	61 x 46 x 12,5	1		<input type="checkbox"/>	<input type="checkbox"/>	F002520CODE	50 670,-/61 311,-
120 x 45,5 x 56	61 x 46 x 12,5	1		<input checked="" type="checkbox"/>	<input type="checkbox"/>	F002536CODE	54 018,-/65 362,-

B-8

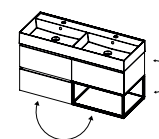

Rozměr nábytku (d x h x v)	Rozměr umyvadla (d x h x v)	Počet otvorů na baterie	Umístění umyvadla	Barva umyvadla	Umístění výřezu v zásuvce na sifon	Obj. č. nábytku bezúchytková černá	Cena
120 x 45,5 x 56	121 x 46 x 12,5	0		<input type="checkbox"/>	<input type="checkbox"/>	F002543CODE	63 961,-/77 393,-
120 x 45,5 x 56	121 x 46 x 12,5	0		<input checked="" type="checkbox"/>	<input type="checkbox"/>	F002549CODE	71 118,-/86 053,-

C-1

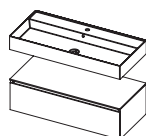

Rozměr nábytku (d x h x v)	Rozměr umyvadla (d x h x v)	Počet otvorů na baterie	Umístění umyvadla	Barva umyvadla	Umístění výřezu v zásuvce na sifon	Obj. č. nábytku be- zúchytková černá	Cena
60 x 45,5 x 28	61 x 46 x 12,5	0		<input type="checkbox"/>	<input type="checkbox"/>	F002556CODE	25 560,-/30 928,-
60 x 45,5 x 28	61 x 46 x 12,5	0		<input checked="" type="checkbox"/>	<input type="checkbox"/>	F002564CODE	29 144,-/35 264,-
60 x 45,5 x 28	61 x 46 x 12,5	1		<input type="checkbox"/>	<input type="checkbox"/>	F002560CODE	24 729,-/29 922,-
60 x 45,5 x 28	61 x 46 x 12,5	1		<input checked="" type="checkbox"/>	<input type="checkbox"/>	F002568CODE	28 065,-/33 959,-
80 x 45,5 x 28	81 x 46 x 12,5	0		<input type="checkbox"/>	<input type="checkbox"/>	F002572CODE	29 211,-/35 345,-
80 x 45,5 x 28	81 x 46 x 12,5	0		<input checked="" type="checkbox"/>	<input type="checkbox"/>	F002580CODE	33 626,-/40 687,-
80 x 45,5 x 28	81 x 46 x 12,5	1		<input type="checkbox"/>	<input type="checkbox"/>	F002576CODE	28 144,-/34 054,-
80 x 45,5 x 28	81 x 46 x 12,5	1		<input checked="" type="checkbox"/>	<input type="checkbox"/>	F002584CODE	32 436,-/39 248,-
100 x 45,5 x 28	101 x 46 x 12,5	0		<input type="checkbox"/>	<input type="checkbox"/>	F002588CODE	32 997,-/39 926,-
100 x 45,5 x 28	101 x 46 x 12,5	0		<input checked="" type="checkbox"/>	<input type="checkbox"/>	F002600CODE	38 256,-/46 290,-
100 x 45,5 x 28	101 x 46 x 12,5	1		<input type="checkbox"/>	<input type="checkbox"/>	F002592CODE	31 807,-/38 486,-
100 x 45,5 x 28	101 x 46 x 12,5	1		<input checked="" type="checkbox"/>	<input type="checkbox"/>	F002604CODE	37 053,-/44 834,-
100 x 45,5 x 28	101 x 46 x 12,5	2		<input type="checkbox"/>	<input type="checkbox"/>	F002596CODE	32 997,-/39 926,-
100 x 45,5 x 28	101 x 46 x 12,5	2		<input checked="" type="checkbox"/>	<input type="checkbox"/>	F002608CODE	38 256,-/46 290,-
120 x 45,5 x 28	121 x 46 x 12,5	0		<input type="checkbox"/>	<input type="checkbox"/>	F002612CODE	39 267,-/47 513,-
120 x 45,5 x 28	121 x 46 x 12,5	0		<input checked="" type="checkbox"/>	<input type="checkbox"/>	F002620CODE	45 929,-/55 574,-
120 x 45,5 x 28	121 x 46 x 12,5	2		<input type="checkbox"/>	<input type="checkbox"/>	F002616CODE	39 267,-/47 513,-

Rozměr nábytku (d x h x v)	Rozměr umyvadla (d x h x v)	Počet otvorů na baterie	Umístění umyvadla	Barva umyvadla	Umístění vyřezu v zásuvce na sifon	Obj. č. nábytku be- zúchytková černá	Cena
120 x 45,5 x 28	121 x 46 x 12,5	2				F002624CODE	45 929,-/55 574,-

C-1

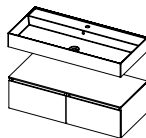

Rozměr nábytku (d x h x v)	Rozměr umyvadla (d x h x v)	Počet otvorů na baterie	Umístění umyvadla	Barva umyvadla	Umístění vyřezu v zásuvce na sifon	Obj. č. nábytku bezúchytková černá	Cena
120 x 45,5 x 28	121 x 46 x 12,5	0				F002644CODE	49 209,-/59 543,-
120 x 45,5 x 28	121 x 46 x 12,5	0				F002652CODE	55 872,-/67 605,-
120 x 45,5 x 28	121 x 46 x 12,5	2				F002648CODE	49 209,-/59 543,-
120 x 45,5 x 28	121 x 46 x 12,5	2				F002656CODE	55 872,-/67 605,-

C-2

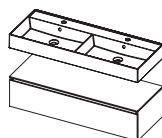

Rozměr nábytku (d x h x v)	Rozměr umyvadla (d x h x v)	Počet otvorů na baterie	Umístění umyvadla	Barva umyvadla	Umístění vyřezu v zásuvce na sifon	Obj. č. nábytku bezúchytková černá	Cena
120 x 45,5 x 28	121 x 46 x 12,5	0				F002628CODE	40 974,-/49 579,-
120 x 45,5 x 28	121 x 46 x 12,5	0				F002636CODE	48 131,-/58 239,-
120 x 45,5 x 28	121 x 46 x 12,5	2				F002632CODE	39 783,-/48 137,-
120 x 45,5 x 28	121 x 46 x 12,5	2				F002640CODE	46 929,-/56 784,-

C-2

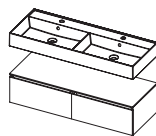

Rozměr nábytku (d x h x v)	Rozměr umyvadla (d x h x v)	Počet otvorů na baterie	Umístění umyvadla	Barva umyvadla	Umístění vyřezu v zásuvce na sifon	Obj. č. nábytku bezúchytková černá	Cena
120 x 45,5 x 28	121 x 46 x 12,5	0				F002660CODE	50 906,-/61 596,-
120 x 45,5 x 28	121 x 46 x 12,5	0				F002668CODE	58 073,-/70 268,-
120 x 45,5 x 28	121 x 46 x 12,5	2				F002664CODE	49 726,-/60 168,-
120 x 45,5 x 28	121 x 46 x 12,5	2				F002672CODE	56 871,-/68 814,-

C-3

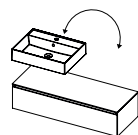

Rozměr nábytku (d x h x v)	Rozměr umyvadla (d x h x v)	Počet otvorů na baterie	Umístění umyvadla	Barva umyvadla	Umístění vyřezu v zásuvce na sifon	Obj. č. nábytku bezúchytková černá	Cena
120 x 45,5 x 28	61 x 46 x 12,5	0				F002677CODE	30 548,-/36 963,-
120 x 45,5 x 28	61 x 46 x 12,5	0				F002693CODE	34 132,-/41 300,-
120 x 45,5 x 28	61 x 46 x 12,5	1				F002685CODE	29 717,-/35 958,-
120 x 45,5 x 28	61 x 46 x 12,5	1				F002701CODE	33 065,-/40 009,-

C-3

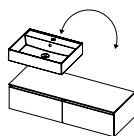

Rozměr nábytku (d x h x v)	Rozměr umyvadla (d x h x v)	Počet otvorů na baterie	Umístění umyvadla	Barva umyvadla	Umístění výřezu v zásuvce na sifon	Obj. č. nábytku bezúchytková černá	Cena
120 x 45,5 x 28	61 x 46 x 12,5	0		<input type="checkbox"/>	<input type="checkbox"/>	F002678CODE	40 503,-/49 009,-
120 x 45,5 x 28	61 x 46 x 12,5	0		<input checked="" type="checkbox"/>	<input type="checkbox"/>	F002694CODE	44 075,-/53 331,-
120 x 45,5 x 28	61 x 46 x 12,5	1		<input type="checkbox"/>	<input type="checkbox"/>	F002686CODE	39 660,-/47 989,-
120 x 45,5 x 28	61 x 46 x 12,5	1		<input checked="" type="checkbox"/>	<input type="checkbox"/>	F002702CODE	42 996,-/52 025,-
160 x 45,5 x 28	81 x 46 x 12,5	0		<input type="checkbox"/>	<input type="checkbox"/>	F002708CODE	45 098,-/54 569,-
160 x 45,5 x 28	81 x 46 x 12,5	0		<input checked="" type="checkbox"/>	<input type="checkbox"/>	F002716CODE	49 501,-/59 896,-
160 x 45,5 x 28	81 x 46 x 12,5	1		<input type="checkbox"/>	<input type="checkbox"/>	F002712CODE	44 019,-/53 263,-
160 x 45,5 x 28	81 x 46 x 12,5	1		<input checked="" type="checkbox"/>	<input type="checkbox"/>	F002720CODE	48 311,-/58 456,-

C-4

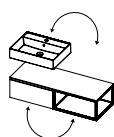

Rozměr nábytku (d x h x v)	Rozměr umyvadla (d x h x v)	Počet otvorů na baterie	Umístění umyvadla	Barva umyvadla	Umístění výřezu v zásuvce na sifon	Obj. č. nábytku bezúchytková černá	Cena
120 x 45,5 x 28	61 x 46 x 12,5	0		<input type="checkbox"/>	<input type="checkbox"/>	F002725CODE	37 536,-/45 419,-
120 x 45,5 x 28	61 x 46 x 12,5	0		<input checked="" type="checkbox"/>	<input type="checkbox"/>	F002733CODE	41 098,-/49 729,-
120 x 45,5 x 28	61 x 46 x 12,5	1		<input type="checkbox"/>	<input type="checkbox"/>	F002729CODE	36 693,-/44 399,-
120 x 45,5 x 28	61 x 46 x 12,5	1		<input checked="" type="checkbox"/>	<input type="checkbox"/>	F002737CODE	40 030,-/48 436,-
160 x 45,5 x 28	81 x 46 x 12,5	0		<input type="checkbox"/>	<input type="checkbox"/>	F002741CODE	41 873,-/50 666,-
160 x 45,5 x 28	81 x 46 x 12,5	0		<input checked="" type="checkbox"/>	<input type="checkbox"/>	F002749CODE	46 288,-/56 008,-
160 x 45,5 x 28	81 x 46 x 12,5	1		<input type="checkbox"/>	<input type="checkbox"/>	F002745CODE	40 795,-/49 362,-
160 x 45,5 x 28	81 x 46 x 12,5	1		<input checked="" type="checkbox"/>	<input type="checkbox"/>	F002753CODE	45 086,-/54 554,-

C-5

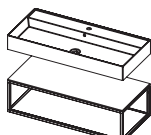

Rozměr nábytku (d x h x v)	Rozměr umyvadla (d x h x v)	Počet otvorů na baterie	Umístění umyvadla	Barva umyvadla	Umístění výřezu v zásuvce na sifon	Rám Buddy černá	Cena
60 x 45,5 x 28	61 x 46 x 12,5	0		<input type="checkbox"/>	<input type="checkbox"/>	F002756CODE	22 604,-/27 351,-
60 x 45,5 x 28	61 x 46 x 12,5	0		<input checked="" type="checkbox"/>	<input type="checkbox"/>	F002760CODE	26 166,-/31 661,-
60 x 45,5 x 28	61 x 46 x 12,5	1		<input type="checkbox"/>	<input type="checkbox"/>	F002758CODE	21 347,-/25 830,-
60 x 45,5 x 28	61 x 46 x 12,5	1		<input checked="" type="checkbox"/>	<input type="checkbox"/>	F002762CODE	24 695,-/29 881,-
80 x 45,5 x 28	81 x 46 x 12,5	0		<input type="checkbox"/>	<input type="checkbox"/>	F002764CODE	25 986,-/31 443,-
80 x 45,5 x 28	81 x 46 x 12,5	0		<input checked="" type="checkbox"/>	<input type="checkbox"/>	F002768CODE	30 402,-/36 786,-
80 x 45,5 x 28	81 x 46 x 12,5	1		<input type="checkbox"/>	<input type="checkbox"/>	F002766CODE	24 841,-/30 058,-
80 x 45,5 x 28	81 x 46 x 12,5	1		<input checked="" type="checkbox"/>	<input type="checkbox"/>	F002770CODE	29 144,-/35 264,-
100 x 45,5 x 28	101 x 46 x 12,5	0		<input type="checkbox"/>	<input type="checkbox"/>	F002772CODE	29 357,-/35 522,-
100 x 45,5 x 28	101 x 46 x 12,5	0		<input checked="" type="checkbox"/>	<input type="checkbox"/>	F002774CODE	28 503,-/34 489,-
100 x 45,5 x 28	101 x 46 x 12,5	1		<input checked="" type="checkbox"/>	<input type="checkbox"/>	F002780CODE	33 762,-/40 852,-
100 x 45,5 x 28	101 x 46 x 12,5	2		<input type="checkbox"/>	<input type="checkbox"/>	F002776CODE	29 706,-/35 944,-
100 x 45,5 x 28	101 x 46 x 12,5	2		<input checked="" type="checkbox"/>	<input type="checkbox"/>	F002782CODE	34 941,-/42 279,-
120 x 45,5 x 28	121 x 46 x 12,5	0		<input type="checkbox"/>	<input type="checkbox"/>	F002784CODE	35 357,-/42 782,-
120 x 45,5 x 28	121 x 46 x 12,5	0		<input checked="" type="checkbox"/>	<input type="checkbox"/>	F002788CODE	42 041,-/50 870,-
120 x 45,5 x 28	121 x 46 x 12,5	2		<input type="checkbox"/>	<input type="checkbox"/>	F002786CODE	35 357,-/42 782,-
120 x 45,5 x 28	121 x 46 x 12,5	2		<input checked="" type="checkbox"/>	<input type="checkbox"/>	F002790CODE	42 041,-/50 870,-
120 x 45,5 x 28	121 x 46 x 12,5	0		<input type="checkbox"/>	<input type="checkbox"/>	F002792CODE	36 683,-/44 386,-
120 x 45,5 x 28	121 x 46 x 12,5	0		<input checked="" type="checkbox"/>	<input type="checkbox"/>	F002796CODE	43 828,-/53 032,-

Rozměr nábytku (d x h x v)	Rozměr umyvadla (d x h x v)	Počet otvorů na baterie	Umístění umyvadla	Barva umyvadla	Umístění vyřezu v zásuvce na sifon	Rám Buddy černá	Cena
120 x 45,5 x 28	121 x 46 x 12,5	2				F002794CODE	35 491,-/42 944,-
120 x 45,5 x 28	121 x 46 x 12,5	2				F002798CODE	42 637,-/51 591,-

C-6

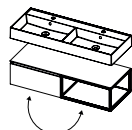

Rozměr nábytku (d x h x v)	Rozměr umyvadla (d x h x v)	Počet otvorů na baterie	Umístění umyvadla	Barva umyvadla	Umístění vyřezu v zásuvce na sifon	Obj. č. nábytku bezúchytková černá	Cena
120 x 45,5 x 28	121 x 46 x 12,5	0				F002801CODE	46 233,-/55 942,-
120 x 45,5 x 28	121 x 46 x 12,5	0				F002809CODE	52 905,-/64 015,-
120 x 45,5 x 28	121 x 46 x 12,5	2				F002805CODE	46 233,-/55 942,-
120 x 45,5 x 28	121 x 46 x 12,5	2				F002813CODE	52 905,-/64 015,-
120 x 45,5 x 28	121 x 46 x 12,5	0				F002817CODE	47 940,-/58 007,-
120 x 45,5 x 28	121 x 46 x 12,5	0				F002825CODE	55 108,-/66 681,-
120 x 45,5 x 28	121 x 46 x 12,5	2				F002821CODE	46 749,-/56 566,-
120 x 45,5 x 28	121 x 46 x 12,5	2				F002829CODE	53 916,-/65 238,-

C-7

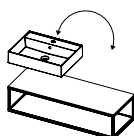

Rozměr nábytku (d x h x v)	Rozměr umyvadla (d x h x v)	Počet otvorů na baterie	Umístění umyvadla	Barva umyvadla	Umístění vyřezu v zásuvce na sifon	Rám Buddy černá	Cena
120 x 45,5 x 28	61 x 46 x 12,5	0				F002832CODE	26 256,-/31 770,-
120 x 45,5 x 28	61 x 46 x 12,5	0				F002836CODE	29 840,-/36 106,-
120 x 45,5 x 28	61 x 46 x 12,5	1				F002834CODE	25 818,-/31 240,-
120 x 45,5 x 28	61 x 46 x 12,5	1				F002838CODE	29 155,-/35 278,-

RIHO

NÁBYTEK





VELVET SLIM

ELEGANTNÍ JEDNODUCHOST

LIVIT VELVET SLIM - umyvadla vyrobená z materiálu SOLID SURFACE s matným povrchem přináší do vaší koupelny jemné a čisté linie. Minimalistické, lehké vestavěné umyvadlo teplého vzhledu. Pokud se vám líbí rafinované tvary a povrchy, jedná se o ideální volbu pro vaši koupelnu.

Materiál SOLID SURFACE s matným povrchem. Krásný minimalistický a příjemný materiál. Není pórovitý, proto se příjemně používá a snadno udržuje. Design a hygiena jdou spolu ruku v ruce.

VELVET SLIM

- Vyrobeno z materiálu SOLID SURFACE
- Matná bílá barva
- Tenké umyvadlo: výška pouze 1,5 cm
- Hloubka umyvadla: 12,8 cm
- Otvory pro baterie:
- délka umyvadla 60, 80, 100 cm -bez otvoru nebo 1 otvor pro baterii
- umyvadlo v délce 120 cm s umístěním vlevo / vpravo - bez otvoru nebo 1 otvor na baterii
- délka 120, 140, 160 cm se 2 umyvadly - žádný nebo 2 otvory pro baterie
- Můžete si objednat bílý nebo černý CLIC-CLAC a místospořicí sifon
- Doporučená teplota vody do 65 ° C

Všechny koupelnové nábytky z řady Livit jsou nabízeny v těchto barevných odstínech:

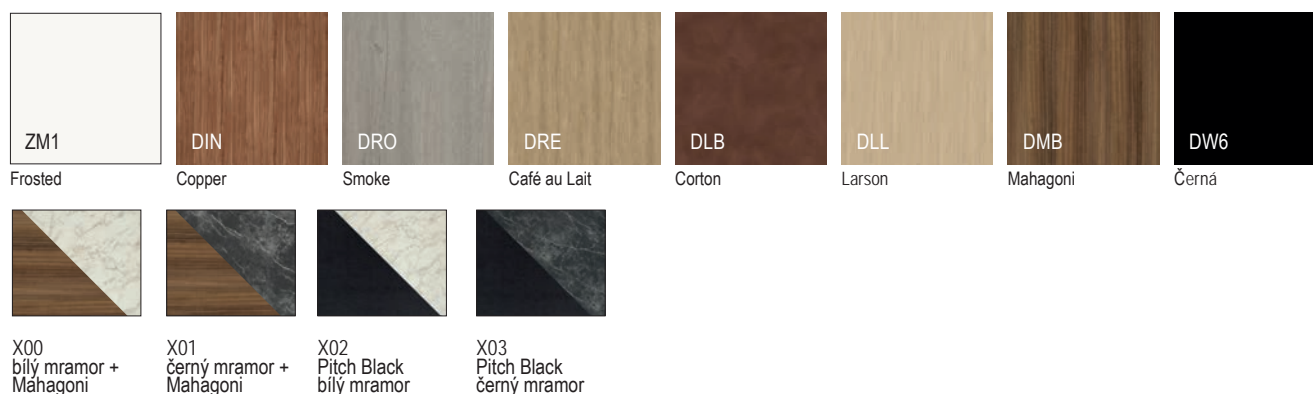

umyvadlo z materiálu SOLID SURFACE v bílé matné barvě



Výřez na sifon v zásuvce

Sety nábytku s umyvadly Livit Velvet Slim

Set A

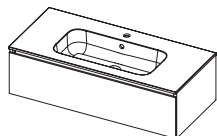

A-1

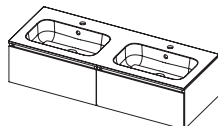

A-2

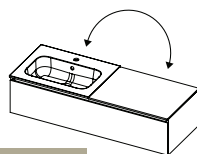

A-3

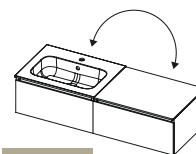

A-3

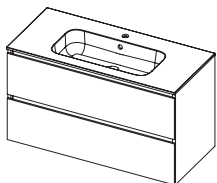

A-4

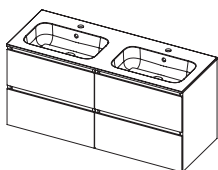

A-5

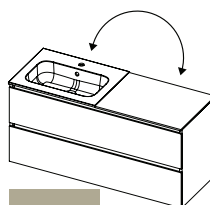

A-6

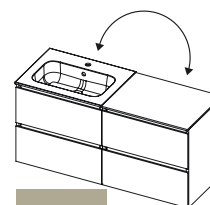

A-6

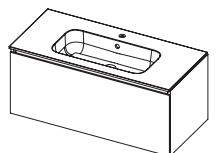

A-7

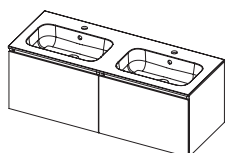

A-8

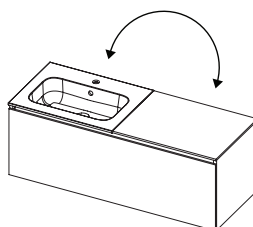

A-9

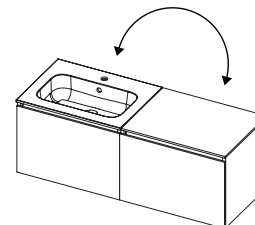

A-9

Set B

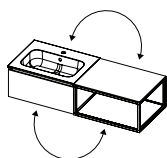

B-4

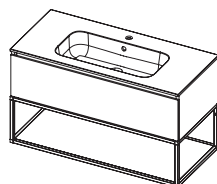

B-5

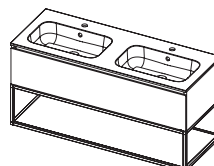

B-6

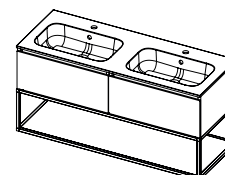

B-6

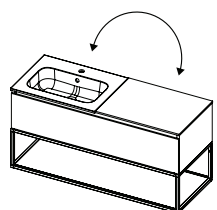

B-7

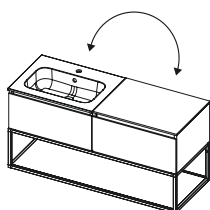

B-7

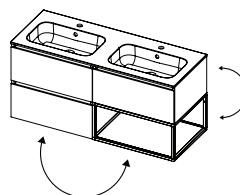

B-8

A-1

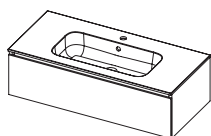

Rozměr nábytku (d x h x v)	Rozměr umyvadla (d x h x v)	Počet otvorů na baterie	Umístění umyvadla	Barva umyvadla	Umístění vyřezu v zásuvce na sifon	Obj. č. nábytku bezúchytková černá	Cena
60 x 45,5 x 28	60,5 x 46 x 1,25	0		<input type="checkbox"/>		F004028CODE	20 919,-/25 312,-
60 x 45,5 x 28	60,5 x 46 x 1,25	1		<input type="checkbox"/>		F004019CODE	20 919,-/25 312,-
80 x 45,5 x 28	80,5 x 46 x 1,25	0		<input type="checkbox"/>		F004034CODE	23 369,-/28 276,-
80 x 45,5 x 28	80,5 x 46 x 1,25	1		<input type="checkbox"/>		F004020CODE	23 369,-/28 276,-
100 x 45,5 x 28	100,5 x 46 x 1,25	0		<input type="checkbox"/>		F004040CODE	25 257,-/30 561,-
100 x 45,5 x 28	100,5 x 46 x 1,25	1		<input type="checkbox"/>		F004021CODE	25 257,-/30 561,-
120 x 45,5 x 28	120,5 x 46 x 1,25	0		<input type="checkbox"/>		F004046CODE	28 706,-/34 734,-
120 x 45,5 x 28	120,5 x 46 x 1,25	1		<input type="checkbox"/>		F004050CODE	28 706,-/34 734,-
120 x 45,5 x 28	120,5 x 46 x 1,25	0		<input type="checkbox"/>		F004054CODE	28 706,-/34 734,-
120 x 45,5 x 28	120,5 x 46 x 1,25	1		<input type="checkbox"/>		F004058CODE	28 706,-/34 734,-
120 x 45,5 x 28	120,5 x 46 x 1,25	0		<input type="checkbox"/>		F004062CODE	31 357,-/37 942,-
120 x 45,5 x 28	120,5 x 46 x 1,25	2		<input type="checkbox"/>		F004022CODE	31 357,-/37 942,-

A-2

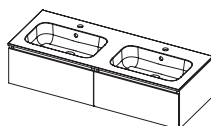

Rozměr nábytku (d x h x v)	Rozměr umyvadla (d x h x v)	Počet otvorů na baterie	Umístění umyvadla	Barva umyvadla	Umístění vyřezu v zásuvce na sifon	Obj. č. nábytku bezúchytková černá	Cena
120 x 45,5 x 28	120,5 x 46 x 1,25	0		<input type="checkbox"/>		F004068CODE	39 053,-/47 254,-
120 x 45,5 x 28	120,5 x 46 x 1,25	1		<input type="checkbox"/>		F004072CODE	39 053,-/47 254,-
120 x 45,5 x 28	120,5 x 46 x 1,25	0		<input type="checkbox"/>		F004076CODE	39 053,-/47 254,-
120 x 45,5 x 28	120,5 x 46 x 1,25	1		<input type="checkbox"/>		F004080CODE	39 053,-/47 254,-
120 x 45,5 x 28	120,5 x 46 x 1,25	0		<input type="checkbox"/>		F004084CODE	41 154,-/49 796,-
120 x 45,5 x 28	120,5 x 46 x 1,25	2		<input type="checkbox"/>		F004088CODE	41 154,-/49 796,-
140 x 45,5 x 28	140,5 x 46 x 1,25	0		<input type="checkbox"/>		F004092CODE	42 603,-/51 550,-
140 x 45,5 x 28	140,5 x 46 x 1,25	2		<input type="checkbox"/>		F004096CODE	42 603,-/51 550,-
160 x 45,5 x 28	160,5 x 46 x 1,25	0		<input type="checkbox"/>		F004100CODE	47 546,-/57 531,-
160 x 45,5 x 28	160,5 x 46 x 1,25	2		<input type="checkbox"/>		F004104CODE	47 546,-/57 531,-

A-3

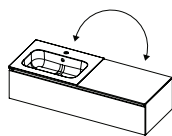

Rozměr nábytku (d x h x v)	Rozměr umyvadla (d x h x v)	Počet otvorů na baterie	Umístění umyvadla	Barva umyvadla	Umístění vyřezu v zásuvce na sifon	Obj. č. nábytku bezúchytková černá	Cena
120 x 45,5 x 28	60,5 x 46 x 1,25	0		<input type="checkbox"/>		F004299CODE	26 526,-/32 096,-
120 x 45,5 x 28	60,5 x 46 x 1,25	1		<input type="checkbox"/>		F004307CODE	26 526,-/32 096,-
120 x 45,5 x 28	60,5 x 46 x 1,25	0		<input type="checkbox"/>		F004300CODE	26 526,-/32 096,-
120 x 45,5 x 28	60,5 x 46 x 1,25	1		<input type="checkbox"/>		F004308CODE	26 526,-/32 096,-

A-3

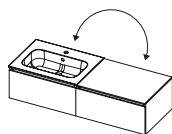

Rozměr nábytku (d x h x v)	Rozměr umyvadla (d x h x v)	Počet otvorů na baterie	Umístění umyvadla	Barva umyvadla	Umístění vyřezu v zásuvce na sifon	Obj. č. nábytku bezúchytková černá	Cena
120 x 45,5 x 28*	60,5 x 46 x 1,25	0		<input type="checkbox"/>		F004108CODE	35 851,-/43 380,-
120 x 45,5 x 28*	60,5 x 46 x 1,25	1		<input type="checkbox"/>		F004112CODE	35 851,-/43 380,-
160 x 45,5 x 28*	80,5 x 46 x 1,25	0		<input type="checkbox"/>		F004116CODE	39 323,-/47 581,-
160 x 45,5 x 28*	80,5 x 46 x 1,25	1		<input type="checkbox"/>		F004120CODE	39 323,-/47 581,-

A-4

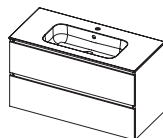

Rozměr nábytku (d x h x v)	Rozměr umyvadla (d x h x v)	Počet otvorů na baterie	Umístění umyvadla	Barva umyvadla	Umístění vyřezu v zásuvce na sifon	Obj. č. nábytku bezúchytková černá	Cena
60 x 45,5 x 56	60,5 x 46 x 1,25	0		<input type="checkbox"/>		F004124CODE	26 593,-/32 178,-
60 x 45,5 x 56	60,5 x 46 x 1,25	1		<input type="checkbox"/>		F004001CODE	26 593,-/32 178,-
80 x 45,5 x 56	80,5 x 46 x 1,25	0		<input type="checkbox"/>		F004130CODE	29 682,-/35 915,-
80 x 45,5 x 56	80,5 x 46 x 1,25	1		<input type="checkbox"/>		F004002CODE	29 682,-/35 915,-
100 x 45,5 x 56	100,5 x 46 x 1,25	0		<input type="checkbox"/>		F004136CODE	32 087,-/38 825,-
100 x 45,5 x 56	100,5 x 46 x 1,25	1		<input type="checkbox"/>		F004003CODE	32 087,-/38 825,-
120 x 45,5 x 56	120,5 x 46 x 1,25	0		<input type="checkbox"/>		F004142CODE	36 121,-/43 706,-
120 x 45,5 x 56	120,5 x 46 x 1,25	1		<input type="checkbox"/>		F004146CODE	36 121,-/43 706,-
120 x 45,5 x 56	120,5 x 46 x 1,25	0		<input type="checkbox"/>		F004150CODE	36 121,-/43 706,-
120 x 45,5 x 56	120,5 x 46 x 1,25	1		<input type="checkbox"/>		F004154CODE	36 121,-/43 706,-
120 x 45,5 x 56	120,5 x 46 x 1,25	0		<input type="checkbox"/>		F004158CODE	38 739,-/46 874,-
120 x 45,5 x 56	120,5 x 46 x 1,25	2		<input type="checkbox"/>		F004004CODE	38 739,-/46 874,-

A-5

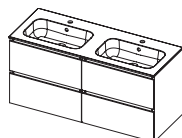

Rozměr nábytku (d x h x v)	Rozměr umyvadla (d x h x v)	Počet otvorů na baterie	Umístění umyvadla	Barva umyvadla	Umístění vyřezu v zásuvce na sifon	Obj. č. nábytku bezúchytková černá	Cena
120 x 45,5 x 56	120,5 x 46 x 1,25	0		<input type="checkbox"/>		F004164CODE	50 434,-/61 025,-
120 x 45,5 x 56	120,5 x 46 x 1,25	1		<input type="checkbox"/>		F004168CODE	50 434,-/61 025,-
120 x 45,5 x 56	120,5 x 46 x 1,25	0		<input type="checkbox"/>		F004172CODE	50 434,-/61 025,-
120 x 45,5 x 56	120,5 x 46 x 1,25	1		<input type="checkbox"/>		F004176CODE	50 434,-/61 025,-
120 x 45,5 x 56	120,5 x 46 x 1,25	0		<input type="checkbox"/>		F004180CODE	52 490,-/63 513,-
120 x 45,5 x 56	120,5 x 46 x 1,25	2		<input type="checkbox"/>		F004184CODE	52 490,-/63 513,-
140 x 45,5 x 56	140,5 x 46 x 1,25	0		<input type="checkbox"/>		F004188CODE	54 411,-/65 837,-
140 x 45,5 x 56	140,5 x 46 x 1,25	2		<input type="checkbox"/>		F004192CODE	54 411,-/65 837,-
160 x 45,5 x 56	160,5 x 46 x 1,25	0		<input type="checkbox"/>		F004196CODE	60 174,-/72 811,-
160 x 45,5 x 56	160,5 x 46 x 1,25	2		<input type="checkbox"/>		F004200CODE	60 174,-/72 811,-

A-6

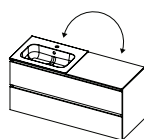

Rozměr nábytku (d x h x v)	Rozměr umyvadla (d x h x v)	Počet otvorů na baterie	Umístění umyvadla	Barva umyvadla	Umístění vyřezu v zásuvce na sifon	Obj. č. nábytku bezúchytková černá	Cena
120 x 45,5 x 56	60,5 x 46 x 1,25	0		<input type="checkbox"/>		F004315CODE	33 952,-/41 082,-
120 x 45,5 x 56	60,5 x 46 x 1,25	1		<input type="checkbox"/>		F004323CODE	33 952,-/41 082,-
120 x 45,5 x 56	60,5 x 46 x 1,25	0		<input type="checkbox"/>		F004316CODE	33 952,-/41 082,-
120 x 45,5 x 56	60,5 x 46 x 1,25	1		<input type="checkbox"/>		F004324CODE	33 952,-/41 082,-

A-6

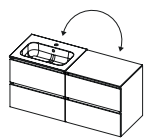

Rozměr nábytku (d x h x v)	Rozměr umyvadla (d x h x v)	Počet otvorů na baterie	Umístění umyvadla	Barva umyvadla	Umístění vyřezu v zásuvce na sifon	Obj. č. nábytku bezúchytková černá	Cena
120 x 45,5 x 56	60,5 x 46 x 1,25	0		<input type="checkbox"/>		F004204CODE	47 209,-/57 123,-
120 x 45,5 x 56	60,5 x 46 x 1,25	1		<input type="checkbox"/>		F004208CODE	48 580,-/58 782,-
160 x 45,5 x 56	80,5 x 46 x 1,25	0		<input type="checkbox"/>		F004212CODE	51 962,-/62 874,-
160 x 45,5 x 56	80,5 x 46 x 1,25	1		<input type="checkbox"/>		F004216CODE	51 962,-/62 874,-

A-7

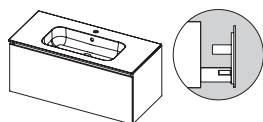

Rozměr nábytku (d x h x v)	Rozměr umyvadla (d x h x v)	Počet otvorů na baterie	Umístění umyvadla	Barva umyvadla	Umístění vyřezu v zásuvce na sifon	Obj. č. nábytku be- zúchytková černá	Cena
60 x 45.50 x 42	60.5 x 46 x 1.25	0		<input type="checkbox"/>	<input type="checkbox"/>	F004353CODE	19 346,-/23 409,-
60 x 45.50 x 42	60.5 x 46 x 1.25	1		<input type="checkbox"/>	<input type="checkbox"/>	F004354CODE	19 346,-/23 409,-
80 x 45.50 x 42	80.5 x 46 x 1.25	0		<input type="checkbox"/>	<input type="checkbox"/>	F004355CODE	21 774,-/26 347,-
80 x 45.50 x 42	80.5 x 46 x 1.25	1		<input type="checkbox"/>	<input type="checkbox"/>	F004356CODE	21 774,-/26 347,-
100 x 45.50 x 42	100.5 x 46 x 1.25	0		<input type="checkbox"/>	<input type="checkbox"/>	F004357CODE	24 122,-/29 188,-
100 x 45.50 x 42	100.5 x 46 x 1.25	1		<input type="checkbox"/>	<input type="checkbox"/>	F004358CODE	24 122,-/29 188,-
120 x 45.50 x 42	120.5 x 46 x 1.25	0		<input type="checkbox"/>	<input type="checkbox"/>	F004359CODE	24 414,-/29 541,-
120 x 45.50 x 42	120.5 x 46 x 1.25	1		<input type="checkbox"/>	<input type="checkbox"/>	F004360CODE	24 414,-/29 541,-
120 x 45.50 x 42	120.5 x 46 x 1.25	0		<input type="checkbox"/>	<input type="checkbox"/>	F004361CODE	25 919,-/31 362,-
120 x 45.50 x 42	120.5 x 46 x 1.25	1		<input type="checkbox"/>	<input type="checkbox"/>	F004362CODE	25 919,-/31 362,-
120 x 45.50 x 42	120.5 x 46 x 1.25	0		<input type="checkbox"/>	<input type="checkbox"/>	F004363CODE	27 504,-/33 280,-
120 x 45.50 x 42	120.5 x 46 x 1.25	2		<input type="checkbox"/>	<input type="checkbox"/>	F004364CODE	27 504,-/33 280,-

A-8



Rozměr nábytku (d x h x v)	Rozměr umyvadla (d x h x v)	Počet otvorů na baterie	Umístění umyvadla	Barva umyvadla	Umístění vyřezu v zásuvce na sifon	Obj. č. nábytku be- zúchytková černá	Cena
120 x 45.50 x 42	120.5 x 46 x 1.25	0		<input type="checkbox"/>	<input type="checkbox"/>	F004365CODE	36 492,-/44 155,-
120 x 45.50 x 42	120.5 x 46 x 1.25	1		<input type="checkbox"/>	<input type="checkbox"/>	F004366CODE	36 492,-/44 155,-
120 x 45.50 x 42	120.5 x 46 x 1.25	0		<input type="checkbox"/>	<input type="checkbox"/>	F004367CODE	36 492,-/44 155,-
120 x 45.50 x 42	120.5 x 46 x 1.25	1		<input type="checkbox"/>	<input type="checkbox"/>	F004368CODE	36 492,-/44 155,-
120 x 45.50 x 42	120.5 x 46 x 1.25	0		<input type="checkbox"/>	<input type="checkbox"/>	F004369CODE	38 053,-/46 044,-
120 x 45.50 x 42	120.5 x 46 x 1.25	2		<input type="checkbox"/>	<input type="checkbox"/>	F004370CODE	38 053,-/46 044,-
140 x 45.50 x 42	140.5 x 46 x 1.25	0		<input type="checkbox"/>	<input type="checkbox"/>	F004371CODE	40 401,-/48 885,-
140 x 45.50 x 42	140.5 x 46 x 1.25	2		<input type="checkbox"/>	<input type="checkbox"/>	F004372CODE	40 401,-/48 885,-
160 x 45.50 x 42	160.5 x 46 x 1.25	0		<input type="checkbox"/>	<input type="checkbox"/>	F004373CODE	44 828,-/54 242,-
160 x 45.50 x 42	160.5 x 46 x 1.25	2		<input type="checkbox"/>	<input type="checkbox"/>	F004374CODE	44 828,-/54 242,-

A-9

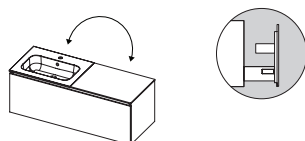

Rozměr nábytku (d x h x v)	Rozměr umyvadla (d x h x v)	Počet otvorů na baterie	Umístění umyvadla	Barva umyvadla	Umístění vyřezu v zásuvce na sifon	Obj. č. nábytku be- zúchytková černá	Cena
120 x 45.50 x 42	60.5 x 46 x 1.25	0		<input type="checkbox"/>	<input type="checkbox"/>	F004375CODE	23 751,-/28 739,-
120 x 45.50 x 42	60.5 x 46 x 1.25	1		<input type="checkbox"/>	<input type="checkbox"/>	F004376CODE	23 751,-/28 739,-

A-9

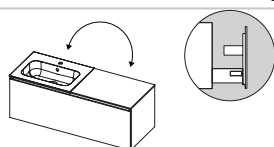

Rozměr nábytku (d x h x v)	Rozměr umyvadla (d x h x v)	Počet otvorů na baterie	Umístění umyvadla	Barva umyvadla	Umístění vyřezu v zásuvce na sifon	Obj. č. nábytku be- zúchytková černá	Cena
120 x 45.50 x 42	60.5 x 46 x 1.25	0		<input type="checkbox"/>	<input type="checkbox"/>	F004377CODE	34 300,-/41 503,-
120 x 45.50 x 42	60.5 x 46 x 1.25	1		<input type="checkbox"/>	<input type="checkbox"/>	F004378CODE	34 300,-/41 503,-
160 x 45.50 x 42	80.5 x 46 x 1.25	0		<input type="checkbox"/>	<input type="checkbox"/>	F004379CODE	38 211,-/46 235,-
160 x 45.50 x 42	80.5 x 46 x 1.25	1		<input type="checkbox"/>	<input type="checkbox"/>	F004380CODE	38 211,-/46 235,-

B-4

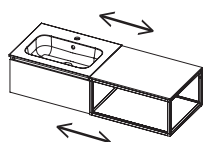

Rozměr nábytku (d x h x v)	Rozměr umyvadla (d x h x v)	Počet otvorů na baterie	Umístění umyvadla	Barva umyvadla	Umístění vyřezu v zásuvce na sifon	Obj. č. nábytku bezúchytková černá	Cena
120 x 45,5 x 28	60,5 x 46 x 1,25	0		<input type="checkbox"/>		F004346CODE	32 873,-/39 776,-
120 x 45,5 x 28	60,5 x 46 x 1,25	1		<input type="checkbox"/>		F004350CODE	32 873,-/39 776,-

B-5

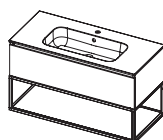

Rozměr nábytku (d x h x v)	Rozměr umyvadla (d x h x v)	Počet otvorů na baterie	Umístění umyvadla	Barva umyvadla	Umístění vyřezu v zásuvce na sifon	Obj. č. nábytku bezúchytková černá	Cena
60 x 45,5 x 56	60,5 x 46 x 1,25	0		<input type="checkbox"/>		F004220CODE	30 987,-/37 494,-
60 x 45,5 x 56	60,5 x 46 x 1,25	1		<input type="checkbox"/>		F004009CODE	30 987,-/37 494,-
80 x 45,5 x 56	80,5 x 46 x 1,25	0		<input type="checkbox"/>		F004226CODE	33 941,-/41 069,-
80 x 45,5 x 56	80,5 x 46 x 1,25	1		<input type="checkbox"/>		F004010CODE	33 941,-/41 069,-
100 x 45,5 x 56	100,5 x 46 x 1,25	0		<input type="checkbox"/>		F004232CODE	36 289,-/43 910,-
100 x 45,5 x 56	100,5 x 46 x 1,25	1		<input type="checkbox"/>		F004011CODE	36 289,-/43 910,-
120 x 45,5 x 56	120,5 x 46 x 1,25	0		<input type="checkbox"/>		F004239CODE	40 558,-/49 075,-
120 x 45,5 x 56	120,5 x 46 x 1,25	1		<input type="checkbox"/>		F004243CODE	40 558,-/49 075,-
120 x 45,5 x 56	120,5 x 46 x 1,25	0		<input type="checkbox"/>		F004247CODE	40 558,-/49 075,-
120 x 45,5 x 56	120,5 x 46 x 1,25	1		<input type="checkbox"/>		F004251CODE	40 558,-/49 075,-

B-6

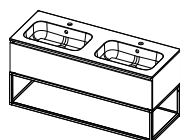

Rozměr nábytku (d x h x v)	Rozměr umyvadla (d x h x v)	Počet otvorů na baterie	Umístění umyvadla	Barva umyvadla	Umístění vyřezu v zásuvce na sifon	Obj. č. nábytku bezúchytková černá	Cena
120 x 45,5 x 56	120,5 x 46 x 1,25	0		<input type="checkbox"/>		F004255CODE	43 210,-/52 284,-
120 x 45,5 x 56	120,5 x 46 x 1,25	2		<input type="checkbox"/>		F004012CODE	43 210,-/52 284,-

B-6

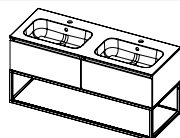





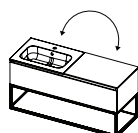

Rozměr nábytku (d x h x v)	Rozměr umyvadla (d x h x v)	Počet otvorů na baterie	Umístění umyvadla	Barva umyvadla	Umístění vyřezu v zásuvce na sifon	Obj. č. nábytku bezúchytková černá	Cena
120 x 45,5 x 56	120,5 x 46 x 1,25	0		<input type="checkbox"/>		F004261CODE	50 906,-/61 596,-
120 x 45,5 x 56	120,5 x 46 x 1,25	1		<input type="checkbox"/>		F004265CODE	50 906,-/61 596,-
120 x 45,5 x 56	120,5 x 46 x 1,25	0		<input type="checkbox"/>		F004269CODE	50 906,-/61 596,-
120 x 45,5 x 56	120,5 x 46 x 1,25	1		<input type="checkbox"/>		F004273CODE	50 906,-/61 596,-
120 x 45,5 x 56	120,5 x 46 x 1,25	0		<input type="checkbox"/>		F004277CODE	53 007,-/64 138,-
120 x 45,5 x 56	120,5 x 46 x 1,25	2		<input type="checkbox"/>		F004281CODE	53 007,-/64 138,-

B-7





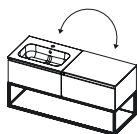

Rozměr nábytku (d x h x v)	Rozměr umyvadla (d x h x v)	Počet ot- vorů na baterie	Umístění umyvadla	Barva umyvadla	Umístění vyřezu v zásuvce na sifon	Obj. č. nábytku bezúchytková černá	Cena
120 x 45,5 x 28	60,5 x 46 x 1,25	0		<input type="checkbox"/>		F004333CODE	38 390,-/46 452,-

Rozměr nábytku (d x h x v)	Rozměr umyvadla (d x h x v)	Počet otvorů na baterie	Umístění umyvadla	Barva umyvadla	Umístění výřezu v zásuvce na sifon	Obj. č. nábytku bezúchytková černá	Cena
120 x 45,5 x 28	60,5 x 46 x 1,25	1		<input type="checkbox"/>		F004341CODE	38 390,-/46 452,-
120 x 45,5 x 28	60,5 x 46 x 1,25	0		<input type="checkbox"/>		F004334CODE	38 390,-/46 452,-
120 x 45,5 x 28	60,5 x 46 x 1,25	1		<input type="checkbox"/>		F004342CODE	38 390,-/46 452,-





B-7

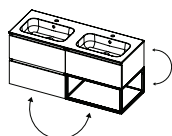

Rozměr nábytku (d x h x v)	Rozměr umyvadla (d x h x v)	Počet otvorů na baterie	Umístění umyvadla	Barva umyvadla	Umístění výřezu v zásuvce na sifon	Obj. č. nábytku bezúchytková černá	Cena
120 x 45,5 x 28	60,5 x 46 x 1,25	0		<input type="checkbox"/>		F004286CODE	48 738,-/58 973,-
120 x 45,5 x 28	60,5 x 46 x 1,25	1		<input type="checkbox"/>		F004290CODE	48 738,-/58 973,-

B-8



Rozměr nábytku (d x h x v)	Rozměr umyvadla (d x h x v)	Počet otvorů na baterie	Umístění umyvadla	Barva umyvadla	Umístění výřezu v zásuvce na sifon	Obj. č. nábytku bezúchytková černá	Cena
60 x 45,5 x 56	120,5 x 46 x 1,25	0		<input type="checkbox"/>		F004294CODE	56 894,-/68 842,-
60 x 45,5 x 56	120,5 x 46 x 1,25	2		<input type="checkbox"/>		F004013CODE	55 850,-/67 579,-



VELVET TOP

JEDINEČNÝ DESIGN

Líbí se vám umyvadlo s vysokým okrajem? Krásnému umyvadlu vyrobenému ze Solid surface materiálu vyhovuje umístění v každé koupelně. Je moderního, minimalistického, venkovského i průmyslového vzhledu. Jeho jednoduchý a elegantní design přináší rovnováhu a harmonii do vaší koupelny. Z matného povrchu materiálu vyzařuje luxus. Zaoblené vnitřní rohy umyvadla zajišťují příjemné použití a snadnou údržbu. Není divu, že je oblíbené u návrhářů interiérů. Líbí se i vám?

- vyrobeno z materiálu Solid Surface
- matná bílá barva
- umyvadlo může být volně zavěšeno na stěně
- výška umyvadla: 12 cm
- hloubka umyvadla: 12,8 cm

VELVET TOP

- Vyrobeno z materiálu SOLID SURFACE
- Matná bílá barva
- Umyvadlo může být volně zavěšeno na stěně
- Výška umyvadla: 12 cm
- Hloubka umyvadla: 12,8 cm
- Otvory pro baterie:
- délka umyvadla 60, 80, 100 cm -bez otvoru nebo 1 otvor pro baterii
- umyvadlo v délce 120 cm s umístěním vlevo / vpravo - bez otvoru nebo 1 otvor na baterii
- délka 120, 140, 160 cm se 2 umyvadly - žádný nebo 2 otvory pro baterie
- Můžete si objednat bílý nebo černý CLIC-CLAC a místospořiči sifon
- Doporučená teplota vody do 65 ° C

Všechny koupelnové nábytky z řady Livit jsou nabízeny v těchto barevných odstínech:

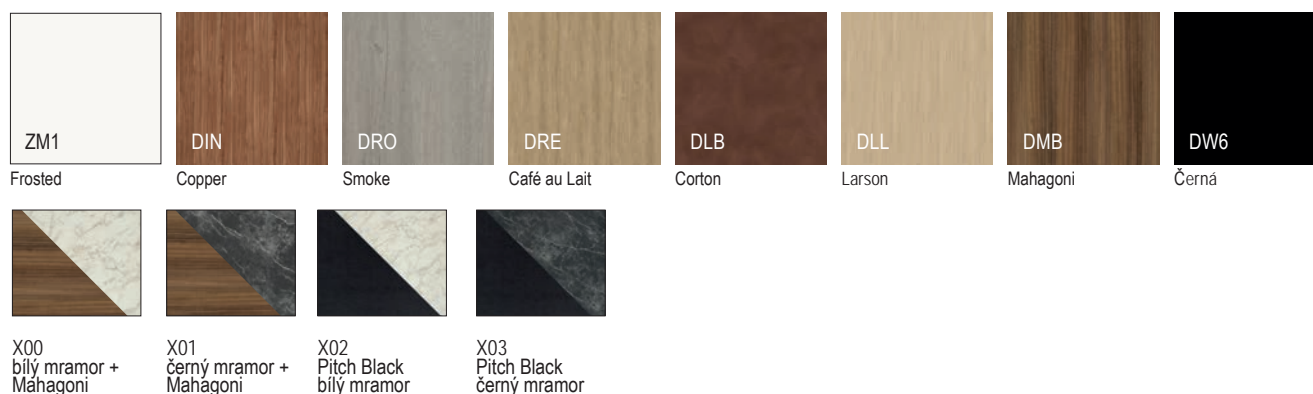

umyvadlo z materiálu SOLID SURFACE v bílé matné barvě

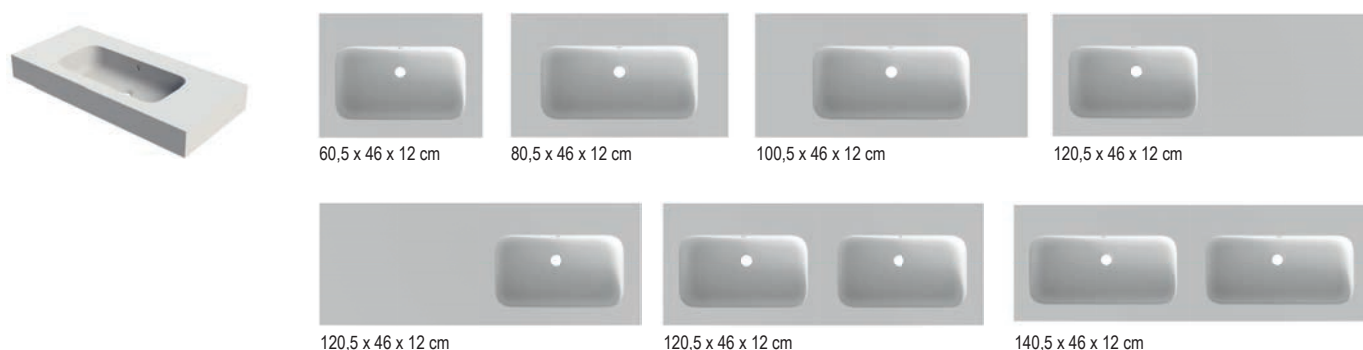

Výřez na sifon v zásuvce

Sety nábytku s umyvadly Livit Velvet Top

Set A

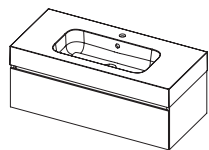

A-1

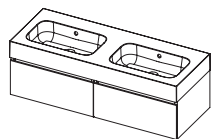

A-2

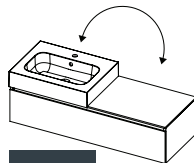

A-3

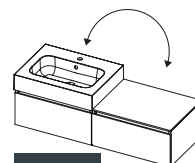

A-3

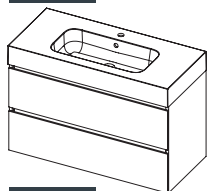

A-4

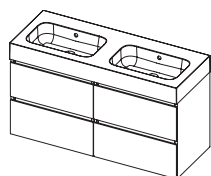

A-5

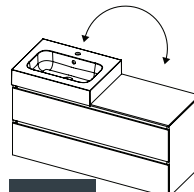

A-6

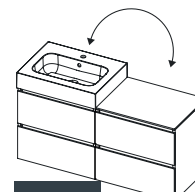

A-6

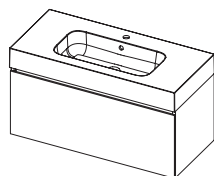

A-7

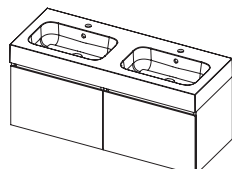

A-8

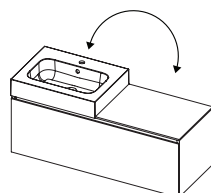

A-9

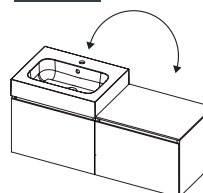

A-9

Set B

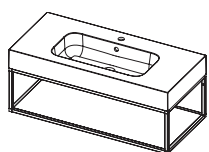

B-1

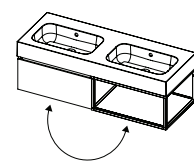

B-2

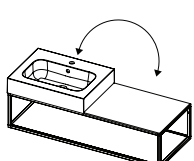

B-3

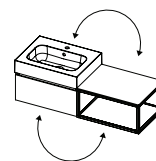

B-4

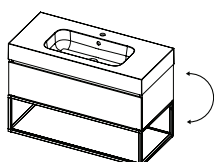

B-5

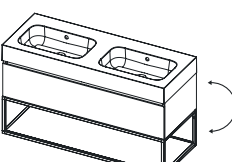

B-6

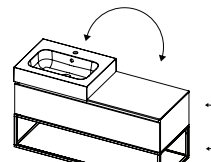

B-7

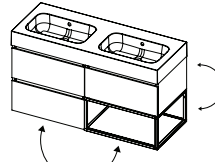

B-8

Set C

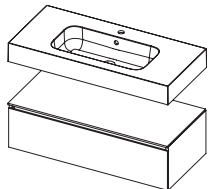

C-1

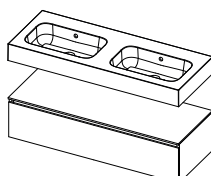

C-2

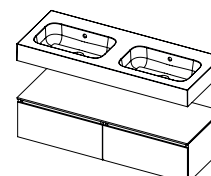

C-2

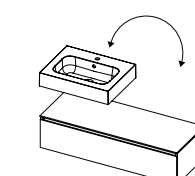

C-3

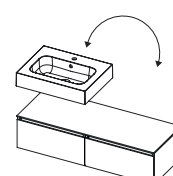

C-3

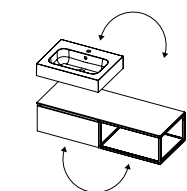

C-4

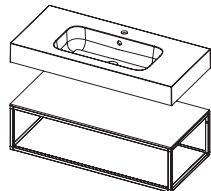

C-5

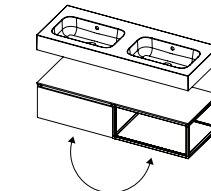

C-6

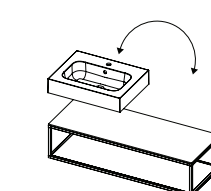

C-7

A-1

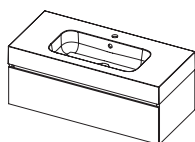

Rozměr nábytku (d x h x v)	Rozměr umyvadla (d x h x v)	Počet otvorů na baterie	Umístění umyvadla	Barva umyvadla	Umístění vyřezu v zásuvce na sifon	Obj. č. nábytku bezúchytková černá	Cena
60 x 45,5 x 28	60,5 x 46 x 12	0		<input type="checkbox"/>		F003002CODE	24 851,-/30 070,-
60 x 45,5 x 28	60,5 x 46 x 12	1		<input type="checkbox"/>		F003006CODE	24 851,-/30 070,-
80 x 45,5 x 28	80,5 x 46 x 12	0		<input type="checkbox"/>		F003010CODE	27 841,-/33 688,-
80 x 45,5 x 28	80,5 x 46 x 12	1		<input type="checkbox"/>		F003014CODE	27 841,-/33 688,-
100 x 45,5 x 28	100,5 x 46 x 12	0		<input type="checkbox"/>		F003018CODE	30 155,-/36 488,-
100 x 45,5 x 28	100,5 x 46 x 12	1		<input type="checkbox"/>		F003022CODE	30 155,-/36 488,-
120 x 45,5 x 28	120,5 x 46 x 12	0		<input type="checkbox"/>		F003026CODE	34 188,-/41 367,-
120 x 45,5 x 28	120,5 x 46 x 12	1		<input type="checkbox"/>		F003030CODE	34 188,-/41 367,-
120 x 45,5 x 28	120,5 x 46 x 12	0		<input type="checkbox"/>		F003034CODE	34 188,-/41 367,-
120 x 45,5 x 28	120,5 x 46 x 12	1		<input type="checkbox"/>		F003038CODE	34 188,-/41 367,-
120 x 45,5 x 28	120,5 x 46 x 12	0		<input type="checkbox"/>		F003042CODE	36 851,-/44 590,-
120 x 45,5 x 28	120,5 x 46 x 12	2		<input type="checkbox"/>		F003046CODE	36 851,-/44 590,-

A-2

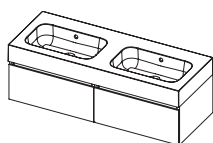

Rozměr nábytku (d x h x v)	Rozměr umyvadla (d x h x v)	Počet otvorů na baterie	Umístění umyvadla	Barva umyvadla	Umístění vyřezu v zásuvce na sifon	Obj. č. nábytku bezúchytková černá	Cena
120 x 45,5 x 28	120,5 x 46 x 12	0		<input type="checkbox"/>		F003050CODE	44 547,-/53 902,-
120 x 45,5 x 28	120,5 x 46 x 12	1		<input type="checkbox"/>		F003054CODE	44 547,-/53 902,-
120 x 45,5 x 28	120,5 x 46 x 12	0		<input type="checkbox"/>		F003058CODE	44 547,-/53 902,-
120 x 45,5 x 28	120,5 x 46 x 12	1		<input type="checkbox"/>		F003062CODE	44 547,-/53 902,-
120 x 45,5 x 28	120,5 x 46 x 12	0		<input type="checkbox"/>		F003066CODE	46 637,-/56 431,-
120 x 45,5 x 28	120,5 x 46 x 12	2		<input type="checkbox"/>		F003070CODE	46 637,-/56 431,-
140 x 45,5 x 28	140,5 x 46 x 12	0		<input type="checkbox"/>		F003074CODE	48 748,-/58 985,-
140 x 45,5 x 28	140,5 x 46 x 12	2		<input type="checkbox"/>		F003078CODE	48 748,-/58 985,-

A-3

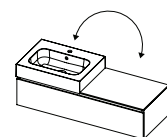

Rozměr nábytku (d x h x v)	Rozměr umyvadla (d x h x v)	Počet otvorů na baterie	Umístění umyvadla	Barva umyvadla	Umístění vyřezu v zásuvce na sifon	Obj. č. nábytku bezúchytková černá	Cena
120 x 45,5 x 28	60,5 x 46 x 12	0		<input type="checkbox"/>		F003539CODE	30 458,-/36 854,-
120 x 45,5 x 28	60,5 x 46 x 12	1		<input type="checkbox"/>		F003547CODE	30 458,-/36 854,-
120 x 45,5 x 28	60,5 x 46 x 12	0		<input type="checkbox"/>		F003540CODE	30 458,-/36 854,-
120 x 45,5 x 28	60,5 x 46 x 12	1		<input type="checkbox"/>		F003548CODE	30 458,-/36 854,-

A-3

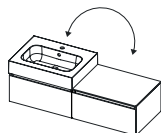

Rozměr nábytku (d x h x v)	Rozměr umyvadla (d x h x v)	Počet otvorů na baterie	Umístění umyvadla	Barva umyvadla	Umístění vyřezu v zásuvce na sifon	Obj. č. nábytku bezúchytková černá	Cena
120 x 45,5 x 28	60,5 x 46 x 12	0		<input type="checkbox"/>		F003082CODE	39 783,-/48 137,-
120 x 45,5 x 28	60,5 x 46 x 12	1		<input type="checkbox"/>		F003086CODE	39 783,-/48 137,-
160 x 45,5 x 28	80,5 x 46 x 12	0		<input type="checkbox"/>		F003090CODE	43 794,-/52 991,-
160 x 45,5 x 28	80,5 x 46 x 12	1		<input type="checkbox"/>		F003094CODE	43 794,-/52 991,-

A-4

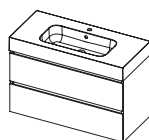

Rozměr nábytku (d x h x v)	Rozměr umyvadla (d x h x v)	Počet otvorů na baterie	Umístění umyvadla	Barva umyvadla	Umístění vyřezu v zásuvce na sifon	Obj. č. nábytku bezúchytková černá	Cena
60 x 45,5 x 56	60,5 x 46 x 12	0		<input type="checkbox"/>		F003098CODE	30 526,-/36 936,-
60 x 45,5 x 56	60,5 x 46 x 12	1		<input type="checkbox"/>		F003102CODE	30 526,-/36 936,-
80 x 45,5 x 56	80,5 x 46 x 12	0		<input type="checkbox"/>		F003106CODE	34 154,-/41 326,-
80 x 45,5 x 56	80,5 x 46 x 12	1		<input type="checkbox"/>		F003110CODE	34 154,-/41 326,-
100 x 45,5 x 56	100,5 x 46 x 12	0		<input type="checkbox"/>		F003114CODE	36 963,-/44 725,-
100 x 45,5 x 56	100,5 x 46 x 12	1		<input type="checkbox"/>		F003118CODE	36 963,-/44 725,-
120 x 45,5 x 56	120,5 x 46 x 12	0		<input type="checkbox"/>		F003122CODE	41 603,-/50 340,-
120 x 45,5 x 56	120,5 x 46 x 12	1		<input type="checkbox"/>		F003126CODE	41 603,-/50 340,-
120 x 45,5 x 56	120,5 x 46 x 12	0		<input type="checkbox"/>		F003130CODE	41 603,-/50 340,-
120 x 45,5 x 56	120,5 x 46 x 12	1		<input type="checkbox"/>		F003134CODE	41 603,-/50 340,-
120 x 45,5 x 56	120,5 x 46 x 12	2		<input type="checkbox"/>		F003138CODE	68 657,-/83 075,-

A-5

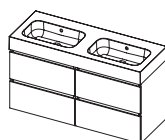

Rozměr nábytku (d x h x v)	Rozměr umyvadla (d x h x v)	Počet otvorů na baterie	Umístění umyvadla	Barva umyvadla	Umístění vyřezu v zásuvce na sifon	Obj. č. nábytku bezúchytková černá	Cena
120 x 45,5 x 56	120,5 x 46 x 12	0		<input type="checkbox"/>		F003146CODE	55 917,-/67 660,-
120 x 45,5 x 56	120,5 x 46 x 12	1		<input type="checkbox"/>		F003150CODE	55 917,-/67 660,-
120 x 45,5 x 56	120,5 x 46 x 12	0		<input type="checkbox"/>		F003154CODE	55 917,-/67 660,-
120 x 45,5 x 56	120,5 x 46 x 12	1		<input type="checkbox"/>		F003158CODE	55 917,-/67 660,-
120 x 45,5 x 56	120,5 x 46 x 12	0		<input type="checkbox"/>		F003162CODE	57 984,-/70 161,-
120 x 45,5 x 56	120,5 x 46 x 12	2		<input type="checkbox"/>		F003166CODE	57 984,-/70 161,-
140 x 45,5 x 56	140,5 x 46 x 12	0		<input type="checkbox"/>		F003170CODE	60 557,-/73 274,-
140 x 45,5 x 56	140,5 x 46 x 12	2		<input type="checkbox"/>		F003174CODE	60 557,-/73 274,-

A-6

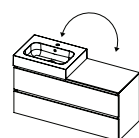

Rozměr nábytku (d x h x v)	Rozměr umyvadla (d x h x v)	Počet otvorů na baterie	Umístění umyvadla	Barva umyvadla	Umístění vyřezu v zásuvce na sifon	Obj. č. nábytku bezúchytková černá	Cena
120 x 45,5 x 56	60,5 x 46 x 12	0		<input type="checkbox"/>		F003555CODE	37 896,-/45 854,-
120 x 45,5 x 56	60,5 x 46 x 12	1		<input type="checkbox"/>		F003563CODE	37 896,-/45 854,-
120 x 45,5 x 56	60,5 x 46 x 12	0		<input type="checkbox"/>		F003556CODE	37 896,-/45 854,-
120 x 45,5 x 56	60,5 x 46 x 12	1		<input type="checkbox"/>		F003564CODE	37 896,-/45 854,-

A-6

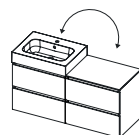

Rozměr nábytku (d x h x v)	Rozměr umyvadla (d x h x v)	Počet otvorů na baterie	Umístění umyvadla	Barva umyvadla	Umístění vyřezu v zásuvce na sifon	Obj. č. nábytku bezúchytková černá	Cena
120 x 45,5 x 56	60,5 x 46 x 12	0		<input type="checkbox"/>		F003178CODE	51 153,-/61 895,-
120 x 45,5 x 56	60,5 x 46 x 12	1		<input type="checkbox"/>		F003182CODE	51 153,-/61 895,-
160 x 45,5 x 56	80,5 x 46 x 12	0		<input type="checkbox"/>		F003186CODE	56 433,-/68 284,-
160 x 45,5 x 56	80,5 x 46 x 12	1		<input type="checkbox"/>		F003190CODE	56 433,-/68 284,-

A-7

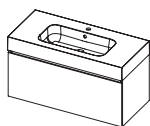

Rozměr nábytku (d x h x v)	Rozměr umyvadla (d x h x v)	Počet otvorů na baterie	Umístění umyvadla	Barva umyvadla	Umístění výřezu v zásuvce na sifon	Obj. č. nábytku be- zúchytková černá	Cena
60 x 45.50 x 42	60.5 x 46 x 12	0		<input type="checkbox"/>	<input type="checkbox"/>	F003585CODE	23 032,-/27 869,-
60 x 45.50 x 42	60.5 x 46 x 12	1		<input type="checkbox"/>	<input type="checkbox"/>	F003586CODE	23 032,-/27 869,-
80 x 45.50 x 42	80.5 x 46 x 12	0		<input type="checkbox"/>	<input type="checkbox"/>	F003587CODE	25 986,-/31 443,-
80 x 45.50 x 42	80.5 x 46 x 12	1		<input type="checkbox"/>	<input type="checkbox"/>	F003588CODE	25 986,-/31 443,-
100 x 45.50 x 42	100.5 x 46 x 12	0		<input type="checkbox"/>	<input type="checkbox"/>	F003589CODE	28 594,-/34 599,-
100 x 45.50 x 42	100.5 x 46 x 12	1		<input type="checkbox"/>	<input type="checkbox"/>	F003590CODE	28 594,-/34 599,-
120 x 45.50 x 42	120.5 x 46 x 12	0		<input type="checkbox"/>	<input type="checkbox"/>	F003591CODE	31 166,-/37 711,-
120 x 45.50 x 42	120.5 x 46 x 12	1		<input type="checkbox"/>	<input type="checkbox"/>	F003592CODE	31 166,-/37 711,-
120 x 45.50 x 42	120.5 x 46 x 12	0		<input type="checkbox"/>	<input type="checkbox"/>	F003593CODE	31 166,-/37 711,-
120 x 45.50 x 42	120.5 x 46 x 12	1		<input type="checkbox"/>	<input type="checkbox"/>	F003594CODE	31 166,-/37 711,-
120 x 45.50 x 42	120.5 x 46 x 12	0		<input type="checkbox"/>	<input type="checkbox"/>	F003595CODE	33 009,-/39 941,-
120 x 45.50 x 42	120.5 x 46 x 12	2		<input type="checkbox"/>	<input type="checkbox"/>	F003596CODE	33 009,-/39 941,-

A-8

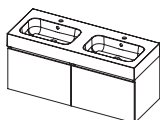

Rozměr nábytku (d x h x v)	Rozměr umyvadla (d x h x v)	Počet otvorů na baterie	Umístění umyvadla	Barva umyvadla	Umístění výřezu v zásuvce na sifon	Obj. č. nábytku be- zúchytková černá	Cena
120 x 45.50 x 42	120.5 x 46 x 12	0		<input type="checkbox"/>	<input type="checkbox"/>	F003597CODE	41 739,-/50 504,-
120 x 45.50 x 42	120.5 x 46 x 12	1		<input type="checkbox"/>	<input type="checkbox"/>	F003598CODE	41 739,-/50 504,-
120 x 45.50 x 42	120.5 x 46 x 12	0		<input type="checkbox"/>	<input type="checkbox"/>	F003599CODE	41 739,-/50 504,-
120 x 45.50 x 42	120.5 x 46 x 12	1		<input type="checkbox"/>	<input type="checkbox"/>	F003600CODE	41 739,-/50 504,-
120 x 45.50 x 42	120.5 x 46 x 12	0		<input type="checkbox"/>	<input type="checkbox"/>	F003601CODE	43 580,-/52 732,-
120 x 45.50 x 42	120.5 x 46 x 12	2		<input type="checkbox"/>	<input type="checkbox"/>	F003602CODE	43 580,-/52 732,-
140 x 45.50 x 42	140.5 x 46 x 12	0		<input type="checkbox"/>	<input type="checkbox"/>	F003603CODE	47 244,-/57 165,-
140 x 45.50 x 42	140.5 x 46 x 12	2		<input type="checkbox"/>	<input type="checkbox"/>	F003604CODE	47 244,-/57 165,-

A-9

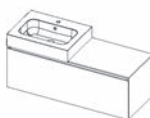

Rozměr nábytku (d x h x v)	Rozměr umyvadla (d x h x v)	Počet otvorů na baterie	Umístění umyvadla	Barva umyvadla	Umístění výřezu v zásuvce na sifon	Obj. č. nábytku be- zúchytková černá	Cena
120 x 45.50 x 42	60.5 x 46 x 12	0		<input type="checkbox"/>	<input type="checkbox"/>	F003605CODE	27 413,-/33 170,-
120 x 45.50 x 42	60.5 x 46 x 12	1		<input type="checkbox"/>	<input type="checkbox"/>	F003606CODE	27 413,-/33 170,-
120 x 45.50 x 42	60.5 x 46 x 12	0		<input type="checkbox"/>	<input type="checkbox"/>	F003607CODE	37 986,-/45 963,-
120 x 45.50 x 42	60.8 x 46 x 12	1		<input type="checkbox"/>	<input type="checkbox"/>	F003608CODE	37 986,-/45 963,-

A-9

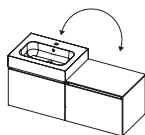

Rozměr nábytku (d x h x v)	Rozměr umyvadla (d x h x v)	Počet otvorů na baterie	Umístění umyvadla	Barva umyvadla	Umístění výřezu v zásuvce na sifon	Obj. č. nábytku be- zúchytková černá	Cena
160 x 45.50 x 42	80.5 x 46 x 12	0		<input type="checkbox"/>	<input type="checkbox"/>	F003609CODE	42 435,-/51 346,-
160 x 45.50 x 42	80.5 x 46 x 12	1		<input type="checkbox"/>	<input type="checkbox"/>	F003610CODE	42 435,-/51 346,-

B-1

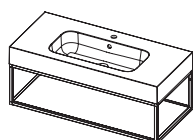

Rozměr nábytku (d x h x v)	Rozměr umyvadla (d x h x v)	Počet otvorů na baterie	Umístění umyvadla	Barva umyvadla	Umístění vyřezu v zásuvce na sifon	Rám Buddy černá	Cena
60 x 45,5 x 28	60,5 x 46 x 12	0		<input type="checkbox"/>		F003194CODE	21 504,-/26 020,-
60 x 45,5 x 28	60,5 x 46 x 12	1		<input type="checkbox"/>		F003196CODE	21 504,-/26 020,-
80 x 45,5 x 28	80,5 x 46 x 12	0		<input type="checkbox"/>		F003198CODE	24 256,-/29 350,-
80 x 45,5 x 28	80,5 x 46 x 12	1		<input type="checkbox"/>		F003200CODE	24 256,-/29 350,-
100 x 45,5 x 28	100,5 x 46 x 12	0		<input type="checkbox"/>		F003202CODE	26 166,-/31 661,-
100 x 45,5 x 28	100,5 x 46 x 12	1		<input type="checkbox"/>		F003204CODE	26 166,-/31 661,-
120 x 45,5 x 28	120,5 x 46 x 12	0		<input type="checkbox"/>		F003206CODE	29 930,-/36 215,-
120 x 45,5 x 28	120,5 x 46 x 12	1		<input type="checkbox"/>		F003208CODE	29 930,-/36 215,-
120 x 45,5 x 28	120,5 x 46 x 12	0		<input type="checkbox"/>		F003210CODE	29 930,-/36 215,-
120 x 45,5 x 28	120,5 x 46 x 12	1		<input type="checkbox"/>		F003212CODE	29 930,-/36 215,-
120 x 45,5 x 28	120,5 x 46 x 12	0		<input type="checkbox"/>		F003214CODE	31 649,-/38 295,-
120 x 45,5 x 28	120,5 x 46 x 12	2		<input type="checkbox"/>		F003216CODE	31 649,-/38 295,-

B-2

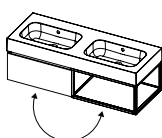

Rozměr nábytku (d x h x v)	Rozměr umyvadla (d x h x v)	Počet otvorů na baterie	Umístění umyvadla	Barva umyvadla	Umístění vyřezu v zásuvce na sifon	Obj. č. nábytku bezúchytková černá	Cena
120 x 45,5 x 28	120,5 x 46 x 12	0		<input type="checkbox"/>		F003218CODE	41 581,-/50 313,-
120 x 45,5 x 28	120,5 x 46 x 12	1		<input type="checkbox"/>		F003222CODE	41 581,-/50 313,-
120 x 45,5 x 28	120,5 x 46 x 12	0		<input type="checkbox"/>		F003226CODE	41 581,-/50 313,-
120 x 45,5 x 28	120,5 x 46 x 12	1		<input type="checkbox"/>		F003230CODE	41 581,-/50 313,-
120 x 45,5 x 28	120,5 x 46 x 12	0		<input type="checkbox"/>		F003234CODE	43 288,-/52 378,-
120 x 45,5 x 28	120,5 x 46 x 12	2		<input type="checkbox"/>		F003238CODE	43 288,-/52 378,-
140 x 45,5 x 28	140,5 x 46 x 12	0		<input type="checkbox"/>		F003242CODE	45 266,-/54 772,-
140 x 45,5 x 28	140,5 x 46 x 12	2		<input type="checkbox"/>		F003246CODE	45 266,-/54 772,-

B-3

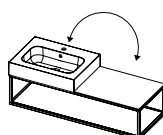

Rozměr nábytku (d x h x v)	Rozměr umyvadla (d x h x v)	Počet otvorů na baterie	Umístění umyvadla	Barva umyvadla	Umístění vyřezu v zásuvce na sifon	Rám Buddy černá	Cena
120 x 45,5 x 28	60,5 x 46 x 12	0		<input type="checkbox"/>		F003250CODE	26 211,-/31 715,-
120 x 45,5 x 28	60,5 x 46 x 12	1		<input type="checkbox"/>		F003252CODE	26 211,-/31 715,-

B-4

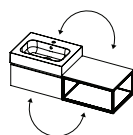

Rozměr nábytku (d x h x v)	Rozměr umyvadla (d x h x v)	Počet otvorů na baterie	Umístění umyvadla	Barva umyvadla	Umístění vyřezu v zásuvce na sifon	Obj. č. nábytku bezúchytková černá	Cena
120 x 45,5 x 28	60,5 x 46 x 12	0		<input type="checkbox"/>		F003254CODE	36 806,-/44 535,-
120 x 45,5 x 28	60,5 x 46 x 12	1		<input type="checkbox"/>		F003258CODE	36 806,-/44 535,-
160 x 45,5 x 28	80,5 x 46 x 12	0		<input type="checkbox"/>		F003262CODE	40 570,-/49 090,-
160 x 45,5 x 28	80,5 x 46 x 12	1		<input type="checkbox"/>		F003266CODE	40 570,-/49 090,-

B-5

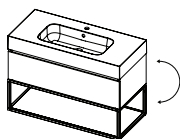

Rozměr nábytku (d x h x v)	Rozměr umyvadla (d x h x v)	Počet otvorů na baterie	Umístění umyvadla	Barva umyvadla	Umístění výřezu v zásuvce na sifon	Obj. č. nábytku bezúchytková černá	Cena
60 x 45,5 x 56	60,5 x 46 x 12	0		<input type="checkbox"/>		F003270CODE	34 929,-/42 264,-
60 x 45,5 x 56	60,5 x 46 x 12	1		<input type="checkbox"/>		F003274CODE	34 929,-/42 264,-
80 x 45,5 x 56	80,5 x 46 x 12	0		<input type="checkbox"/>		F003278CODE	38 412,-/46 479,-
80 x 45,5 x 56	80,5 x 46 x 12	1		<input type="checkbox"/>		F003282CODE	38 412,-/46 479,-
100 x 45,5 x 56	100,5 x 46 x 12	0		<input type="checkbox"/>		F003286CODE	41 187,-/49 836,-
100 x 45,5 x 56	100,5 x 46 x 12	1		<input type="checkbox"/>		F003290CODE	41 187,-/49 836,-
120 x 45,5 x 56	120,5 x 46 x 12	0		<input type="checkbox"/>		F003294CODE	46 041,-/55 710,-
120 x 45,5 x 56	120,5 x 46 x 12	1		<input type="checkbox"/>		F003298CODE	46 041,-/55 710,-
120 x 45,5 x 56	120,5 x 46 x 12	0		<input type="checkbox"/>		F003302CODE	46 041,-/55 710,-
120 x 45,5 x 56	120,5 x 46 x 12	1		<input type="checkbox"/>		F003306CODE	46 041,-/55 710,-

B-6

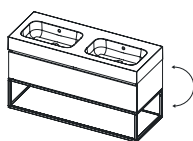

Rozměr nábytku (d x h x v)	Rozměr umyvadla (d x h x v)	Počet otvorů na baterie	Umístění umyvadla	Barva umyvadla	Umístění výřezu v zásuvce na sifon	Obj. č. nábytku bezúchytková černá	Cena
120 x 45,5 x 56	120,5 x 46 x 12	0		<input type="checkbox"/>		F003310CODE	48 704,-/58 932,-
120 x 45,5 x 56	120,5 x 46 x 12	2		<input type="checkbox"/>		F003314CODE	48 704,-/58 932,-

B-6

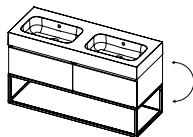

Rozměr nábytku (d x h x v)	Rozměr umyvadla (d x h x v)	Počet otvorů na baterie	Umístění umyvadla	Barva umyvadla	Umístění výřezu v zásuvce na sifon	Obj. č. nábytku bezúchytková černá	Cena
120 x 45,5 x 56	120,5 x 46 x 12	0		<input type="checkbox"/>		F003318CODE	56 400,-/68 244,-
120 x 45,5 x 56	120,5 x 46 x 12	1		<input type="checkbox"/>		F003322CODE	56 400,-/68 244,-
120 x 45,5 x 56	120,5 x 46 x 12	0		<input type="checkbox"/>		F003326CODE	56 400,-/68 244,-
120 x 45,5 x 56	120,5 x 46 x 12	1		<input type="checkbox"/>		F003330CODE	56 400,-/68 244,-
120 x 45,5 x 56	120,5 x 46 x 12	0		<input type="checkbox"/>		F003334CODE	58 489,-/70 772,-
120 x 45,5 x 56	120,5 x 46 x 12	2		<input type="checkbox"/>		F003338CODE	58 489,-/70 772,-

B-7

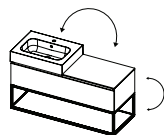

Rozměr nábytku (d x h x v)	Rozměr umyvadla (d x h x v)	Počet otvorů na baterie	Umístění umyvadla	Barva umyvadla	Umístění výřezu v zásuvce na sifon	Obj. č. nábytku bezúchytková černá	Cena
120 x 45,5 x 56	60,5 x 46 x 12	0		<input type="checkbox"/>		F003573CODE	42 311,-/51 196,-
120 x 45,5 x 56	60,5 x 46 x 12	1		<input type="checkbox"/>		F003581CODE	42 311,-/51 196,-
120 x 45,5 x 56	60,5 x 46 x 12	0		<input type="checkbox"/>		F003574CODE	42 311,-/51 196,-
120 x 45,5 x 56	60,5 x 46 x 12	1		<input type="checkbox"/>		F003582CODE	42 311,-/51 196,-

B-7

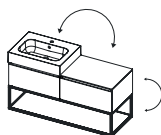

Rozměr nábytku (d x h x v)	Rozměr umyvadla (d x h x v)	Počet otvorů na baterie	Umístění umyvadla	Barva umyvadla	Umístění vyřezu v zásuvce na sifon	Obj. č. nábytku bezúchytková černá	Cena
120 x 45,5 x 56	60,5 x 46 x 12	0		<input type="checkbox"/>	<input type="checkbox"/>	F003343CODE	52 681,-/63 744,-
120 x 45,5 x 56	60,5 x 46 x 12	1		<input type="checkbox"/>	<input type="checkbox"/>	F003347CODE	52 681,-/63 744,-

B-8

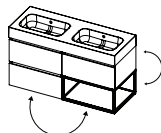

Rozměr nábytku (d x h x v)	Rozměr umyvadla (d x h x v)	Počet otvorů na baterie	Umístění umyvadla	Barva umyvadla	Umístění vyřezu v zásuvce na sifon	Obj. č. nábytku bezúchytková černá	Cena
120 x 45,5 x 56	120,5 x 46 x 12	0		<input type="checkbox"/>	<input type="checkbox"/>	F003351CODE	62 006,-/75 027,-
120 x 45,5 x 56	120,5 x 46 x 12	2		<input type="checkbox"/>	<input type="checkbox"/>	F003355CODE	62 006,-/75 027,-

C-1

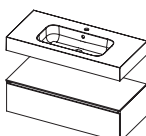

Rozměr nábytku (d x h x v)	Rozměr umyvadla (d x h x v)	Počet otvorů na baterie	Umístění umyvadla	Barva umyvadla	Umístění vyřezu v zásuvce na sifon	Obj. č. nábytku bezúchytková černá	Cena
60 x 45,5 x 28	60,5 x 46 x 12	0		<input type="checkbox"/>	<input type="checkbox"/>	F003358CODE	26 369,-/31 906,-
60 x 45,5 x 28	60,5 x 46 x 12	1		<input type="checkbox"/>	<input type="checkbox"/>	F003362CODE	26 369,-/31 906,-
80 x 45,5 x 28	80,5 x 46 x 12	0		<input type="checkbox"/>	<input type="checkbox"/>	F003366CODE	29 660,-/35 889,-
80 x 45,5 x 28	80,5 x 46 x 12	1		<input type="checkbox"/>	<input type="checkbox"/>	F003370CODE	29 660,-/35 889,-
100 x 45,5 x 28	100,5 x 46 x 12	0		<input type="checkbox"/>	<input type="checkbox"/>	F003374CODE	32 244,-/39 015,-
100 x 45,5 x 28	100,5 x 46 x 12	1		<input type="checkbox"/>	<input type="checkbox"/>	F003378CODE	32 244,-/39 015,-
120 x 45,5 x 28	120,5 x 46 x 12	0		<input type="checkbox"/>	<input type="checkbox"/>	F003382CODE	36 952,-/44 712,-
120 x 45,5 x 28	120,5 x 46 x 12	1		<input type="checkbox"/>	<input type="checkbox"/>	F003386CODE	36 952,-/44 712,-
120 x 45,5 x 28	120,5 x 46 x 12	0		<input type="checkbox"/>	<input type="checkbox"/>	F003390CODE	36 952,-/44 712,-
120 x 45,5 x 28	120,5 x 46 x 12	1		<input type="checkbox"/>	<input type="checkbox"/>	F003394CODE	36 952,-/44 712,-
120 x 45,5 x 28	120,5 x 46 x 12	0		<input type="checkbox"/>	<input type="checkbox"/>	F003398CODE	38 670,-/46 791,-
120 x 45,5 x 28	120,5 x 46 x 12	2		<input type="checkbox"/>	<input type="checkbox"/>	F003402CODE	38 670,-/46 791,-

C-2

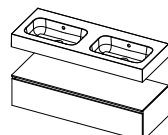

Rozměr nábytku (d x h x v)	Rozměr umyvadla (d x h x v)	Počet otvorů na baterie	Umístění umyvadla	Barva umyvadla	Umístění vyřezu v zásuvce na sifon	Obj. č. nábytku bezúchytková černá	Cena
120 x 45,5 x 28	120,5 x 46 x 12	0		<input type="checkbox"/>	<input type="checkbox"/>	F003406CODE	46 895,-/56 743,-
120 x 45,5 x 28	120,5 x 46 x 12	1		<input type="checkbox"/>	<input type="checkbox"/>	F003410CODE	46 895,-/56 743,-
120 x 45,5 x 28	120,5 x 46 x 12	0		<input type="checkbox"/>	<input type="checkbox"/>	F003414CODE	46 895,-/56 743,-
120 x 45,5 x 28	120,5 x 46 x 12	1		<input type="checkbox"/>	<input type="checkbox"/>	F003418CODE	46 895,-/56 743,-
120 x 45,5 x 28	120,5 x 46 x 12	0		<input type="checkbox"/>	<input type="checkbox"/>	F003422CODE	48 614,-/58 823,-
120 x 45,5 x 28	120,5 x 46 x 12	2		<input type="checkbox"/>	<input type="checkbox"/>	F003426CODE	48 614,-/58 823,-
140 x 45,5 x 28	140,5 x 46 x 12	0		<input type="checkbox"/>	<input type="checkbox"/>	F003430CODE	50 299,-/60 862,-
140 x 45,5 x 28	140,5 x 46 x 12	2		<input type="checkbox"/>	<input type="checkbox"/>	F003434CODE	50 299,-/60 862,-

C-3

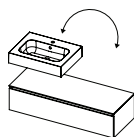

Rozměr nábytku (d x h x v)	Rozměr umyvadla (d x h x v)	Počet otvorů na baterie	Umístění umyvadla	Barva umyvadla	Umístění vyřezu v zásuvce na sifon	Obj. č. nábytku bezúchytková černá	Cena
120 x 45,5 x 28	60,5 x 46 x 12	0	<input checked="" type="checkbox"/>	<input type="checkbox"/>	<input type="checkbox"/>	F003439CODE	31 357,-/37 942,-
120 x 45,5 x 28	60,5 x 46 x 12	1	<input checked="" type="checkbox"/>	<input type="checkbox"/>	<input type="checkbox"/>	F003447CODE	31 357,-/37 942,-

C-3

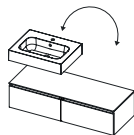

Rozměr nábytku (d x h x v)	Rozměr umyvadla (d x h x v)	Počet otvorů na baterie	Umístění umyvadla	Barva umyvadla	Umístění vyřezu v zásuvce na sifon	Obj. č. nábytku bezúchytková černá	Cena
120 x 45,5 x 28	60,5 x 46 x 12	0	<input checked="" type="checkbox"/>	<input type="checkbox"/>	<input type="checkbox"/>	F003440CODE	41 289,-/49 960,-
120 x 45,5 x 28	60,5 x 46 x 12	1	<input checked="" type="checkbox"/>	<input type="checkbox"/>	<input type="checkbox"/>	F003448CODE	41 289,-/49 960,-
160 x 45,5 x 28	80,5 x 46 x 12	0	<input checked="" type="checkbox"/>	<input type="checkbox"/>	<input type="checkbox"/>	F003454CODE	45 524,-/55 084,-
160 x 45,5 x 28	80,5 x 46 x 12	1	<input checked="" type="checkbox"/>	<input type="checkbox"/>	<input type="checkbox"/>	F003458CODE	45 524,-/55 084,-

C-4

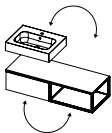

Rozměr nábytku (d x h x v)	Rozměr umyvadla (d x h x v)	Počet otvorů na baterie	Umístění umyvadla	Barva umyvadla	Umístění vyřezu v zásuvce na sifon	Obj. č. nábytku bezúchytková černá	Cena
120 x 45,5 x 28	60,5 x 46 x 12	0	<input checked="" type="checkbox"/>	<input type="checkbox"/>	<input type="checkbox"/>	F003462CODE	38 323,-/46 371,-
120 x 45,5 x 28	60,5 x 46 x 12	1	<input checked="" type="checkbox"/>	<input type="checkbox"/>	<input type="checkbox"/>	F003466CODE	38 323,-/46 371,-
160 x 45,5 x 28	80,5 x 46 x 12	0	<input checked="" type="checkbox"/>	<input type="checkbox"/>	<input type="checkbox"/>	F003470CODE	42 300,-/51 183,-
160 x 45,5 x 28	80,5 x 46 x 12	1	<input checked="" type="checkbox"/>	<input type="checkbox"/>	<input type="checkbox"/>	F003474CODE	42 300,-/51 183,-

C-5

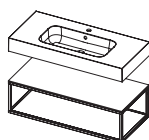

Rozměr nábytku (d x h x v)	Rozměr umyvadla (d x h x v)	Počet otvorů na baterie	Umístění umyvadla	Barva umyvadla	Umístění vyřezu v zásuvce na sifon	Rám Buddy černá	Cena
60 x 45,5 x 28	60,5 x 46 x 12	0	<input checked="" type="checkbox"/>	<input type="checkbox"/>	<input type="checkbox"/>	F003478CODE	23 391,-/28 303,-
80 x 45,5 x 28	80,5 x 46 x 12	0	<input checked="" type="checkbox"/>	<input type="checkbox"/>	<input type="checkbox"/>	F003198CODE	24 256,-/29 350,-
80 x 45,5 x 28	80,5 x 46 x 12	0	<input checked="" type="checkbox"/>	<input type="checkbox"/>	<input type="checkbox"/>	F003482CODE	26 424,-/31 973,-
100 x 45,5 x 28	100,5 x 46 x 12	0	<input checked="" type="checkbox"/>	<input type="checkbox"/>	<input type="checkbox"/>	F003486CODE	28 616,-/34 625,-
120 x 45,5 x 28	120,5 x 46 x 12	0	<input checked="" type="checkbox"/>	<input type="checkbox"/>	<input type="checkbox"/>	F003490CODE	32 660,-/39 519,-
120 x 45,5 x 28	120,5 x 46 x 12	0	<input checked="" type="checkbox"/>	<input type="checkbox"/>	<input type="checkbox"/>	F003494CODE	32 660,-/39 519,-
120 x 45,5 x 28	120,5 x 46 x 12	0	<input checked="" type="checkbox"/>	<input type="checkbox"/>	<input type="checkbox"/>	F003498CODE	34 379,-/41 599,-
60 x 45,5 x 28	60,5 x 46 x 12	1	<input checked="" type="checkbox"/>	<input type="checkbox"/>	<input type="checkbox"/>	F003480CODE	23 391,-/28 303,-
80 x 45,5 x 28	80,5 x 46 x 12	1	<input checked="" type="checkbox"/>	<input type="checkbox"/>	<input type="checkbox"/>	F003484CODE	26 424,-/31 973,-
100 x 45,5 x 28	100,5 x 46 x 12	1	<input checked="" type="checkbox"/>	<input type="checkbox"/>	<input type="checkbox"/>	F003488CODE	28 616,-/34 625,-
120 x 45,5 x 28	120,5 x 46 x 12	1	<input checked="" type="checkbox"/>	<input type="checkbox"/>	<input type="checkbox"/>	F003492CODE	32 660,-/39 519,-
120 x 45,5 x 28	120,5 x 46 x 12	1	<input checked="" type="checkbox"/>	<input type="checkbox"/>	<input type="checkbox"/>	F003496CODE	32 660,-/39 519,-
120 x 45,5 x 28	120,5 x 46 x 12	2	<input checked="" type="checkbox"/>	<input type="checkbox"/>	<input type="checkbox"/>	F003500CODE	34 379,-/41 599,-

C-6

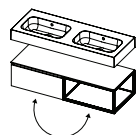

Rozměr nábytku (d x h x v)	Rozměr umyvadla (d x h x v)	Počet otvorů na baterie	Umístění umyvadla	Barva umyvadla	Umístění vyřezu v zásuvce na sifon	Obj. č. nábytku bezúchytková černá	Cena
120 x 45,5 x 28	120,5 x 46 x 12	0		<input type="checkbox"/>	<input type="checkbox"/>	F003502CODE	43 929,-/53 154,-
120 x 45,5 x 28	120,5 x 46 x 12	1		<input type="checkbox"/>	<input type="checkbox"/>	F003506CODE	43 929,-/53 154,-
120 x 45,5 x 28	120,5 x 46 x 12	0		<input type="checkbox"/>	<input type="checkbox"/>	F003510CODE	43 929,-/53 154,-
120 x 45,5 x 28	120,5 x 46 x 12	1		<input type="checkbox"/>	<input type="checkbox"/>	F003514CODE	43 929,-/53 154,-
120 x 45,5 x 28	120,5 x 46 x 12	0		<input type="checkbox"/>	<input type="checkbox"/>	F003518CODE	45 648,-/55 234,-
120 x 45,5 x 28	120,5 x 46 x 12	2		<input type="checkbox"/>	<input type="checkbox"/>	F003522CODE	45 648,-/55 234,-
140 x 45,5 x 28	140,5 x 46 x 12	0		<input type="checkbox"/>	<input type="checkbox"/>	F003526CODE	47 490,-/57 463,-
140 x 45,5 x 28	140,5 x 46 x 12	2		<input type="checkbox"/>	<input type="checkbox"/>	F003530CODE	47 490,-/57 463,-

C-7

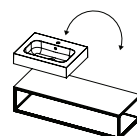

Rozměr nábytku (d x h x v)	Rozměr umyvadla (d x h x v)	Počet otvorů na baterie	Umístění umyvadla	Barva umyvadla	Umístění vyřezu v zásuvce na sifon	Rám Buddy černá	Cena
120 x 45,5 x 28	60,5 x 46 x 12	0		<input type="checkbox"/>	<input type="checkbox"/>	F003534CODE	27 065,-/32 749,-
120 x 45,5 x 28	60,5 x 46 x 12	1		<input type="checkbox"/>	<input type="checkbox"/>	F003536CODE	27 065,-/32 749,-





LIVIT STONE SLIM

HRA TEXTURY

Přírodní materiály mají neutuchající kouzlo. To vaší koupelně dodá umyvadlo LIVIT STONE SLIM, které je vyrobeno z pryskyřice ve vzhledu přírodní břidlice. Strukturovaný povrch s kontrastem hladké plochy uvnitř umyvadla upoutá vaši pozornost a vytváří hluboký dotykový dojem.

- umyvadlo je vyrobeno z polyuretanové pryskyřice
- barva umyvadla - černá s břidlicovou strukturou
- hladká vnitřní struktura umyvadla
- tenké umyvadlo s výškou pouze 1,3 cm
- hloubka umyvadla: 9 cm

LIVIT STONE SLIM

- Umyvadlo je vyrobeno z polyuretanové pryskyřice
- Barva umyvadla - černá s břidlicovou strukturou
- Hladká vnitřní struktura umyvadla
- Tenké umyvadlo s výškou pouze 1,3 cm
- Hloubka umyvadla: 9 cm
- Otvory pro baterie:
- 60, 80, 100 cm - 1 otvor pro baterii
- 120, 140 cm se dvěma umyvadly -2 otvory pro baterie
- Díky místospořicímu sifonu je omezení prostoru v zásuvce minimální
- Bezpřepadové provedení
- Můžete si objednat bílý nebo černý neuzavíratelný CLIC-CLAC a místospořicí sifon
- Doporučená teplota vody do 65 ° C

Všechny koupelnové nábytky z řady Livit jsou nabízeny v těchto barevných odstínech:

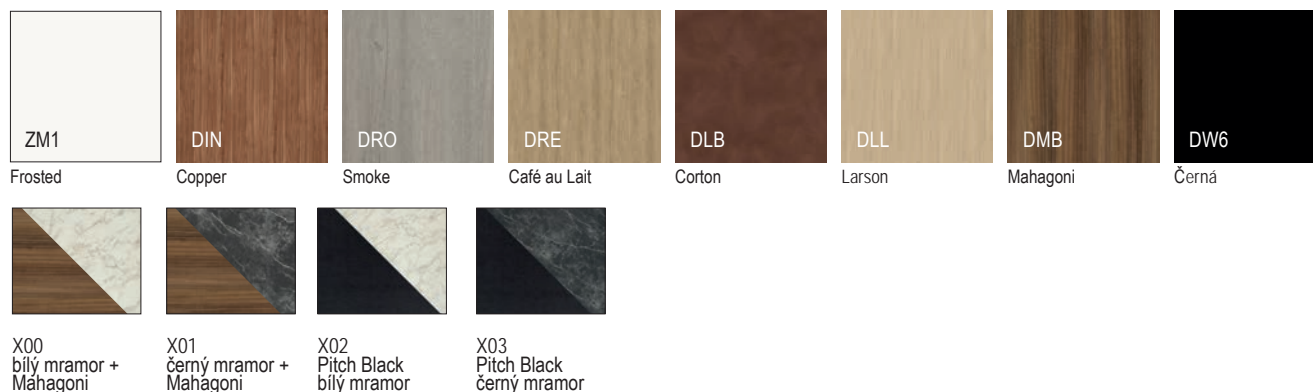

umyvadlo je vyrobeno z polyuretanové pryskyřice, matná černá barva s břidlicovou strukturou



60,3 x 46 x 1,3 cm



80,3 x 46 x 1,3 cm



100,3 x 46 x 1,3 cm



120,3 x 46 x 1,3 cm



140,3 x 46 x 1,3 cm

Výřez na sifon v zásuvce

Sety nábytku s umyvadly Livit Stone Slim

Set A

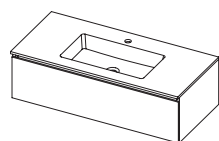

A-1

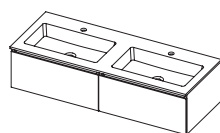

A-2

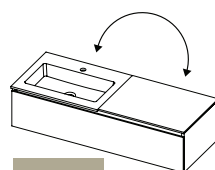

A-3

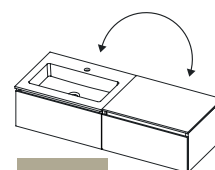

A-3

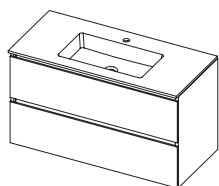

A-4

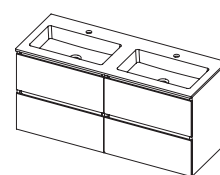

A-5

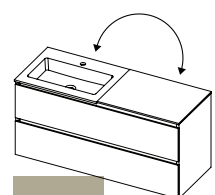

A-6

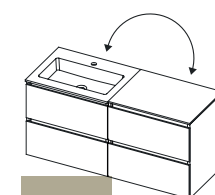

A-6

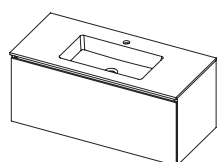

A-7

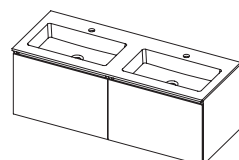

A-8

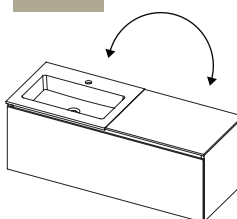

A-9

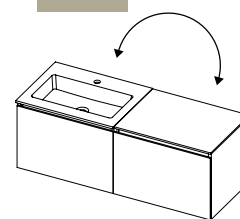

A-9

Set B

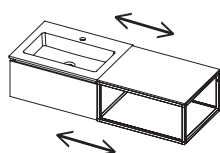

B-4

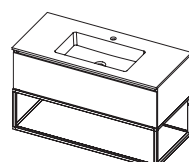

B-5

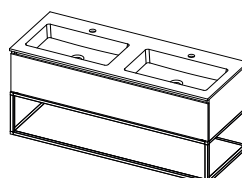

B-6

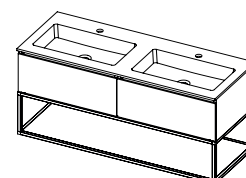

B-6

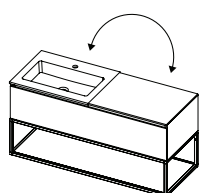

B-7

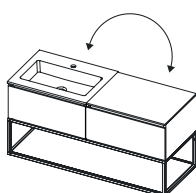

B-7

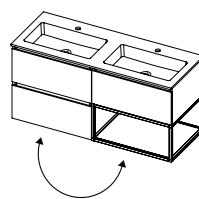

B-8

A-1

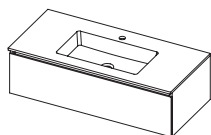

Rozměr nábytku (d x h x v)	Rozměr umyvadla (d x h x v)	Počet otvorů na baterie	Umístění umyvadla	Barva umyvadla	Umístění vyřezu v zásuvce na sifon	Obj. č. nábytku bezúchytková černá	Cena
60 x 45,5 x 28	60,3 x 46 x 1,3	1				F006019CODE	24 122,-/29 188,-
80 x 45,5 x 28	80,3 x 46 x 1,3	1				F006020CODE	26 761,-/32 381,-
100 x 45,5 x 28	100,3 x 46 x 1,3	1				F006034CODE	30 121,-/36 446,-
100 x 45,5 x 28	100,3 x 46 x 1,3	1				F006021CODE	30 132,-/36 460,-
100 x 45,5 x 28	100,3 x 46 x 1,3	1				F006038CODE	30 121,-/36 446,-
120 x 45,5 x 28	120,3 x 46 x 1,3	2				F006022CODE	37 704,-/45 622,-

A-2

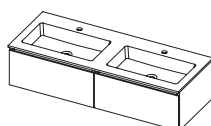

Rozměr nábytku (d x h x v)	Rozměr umyvadla (d x h x v)	Počet otvorů na baterie	Umístění umyvadla	Barva umyvadla	Umístění vyřezu v zásuvce na sifon	Obj. č. nábytku bezúchytková černá	Cena
120 x 45,5 x 28	120,3 x 46 x 1,3	2				F006044CODE	47 502,-/57 477,-
140 x 45,5 x 28	140,3 x 46 x 1,3	2				F006048CODE	50 737,-/61 392,-

A-3

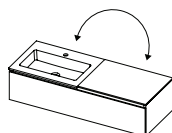

Rozměr nábytku (d x h x v)	Rozměr umyvadla (d x h x v)	Počet otvorů na baterie	Umístění umyvadla	Barva umyvadla	Umístění vyřezu v zásuvce na sifon	Obj. č. nábytku bezúchytková černá	Cena
120 x 45,5 x 28	60,3 x 46 x 1,3	1				F006127CODE	29 728,-/35 971,-
120 x 45,5 x 28	60,3 x 46 x 1,3	1				F006128CODE	29 728,-/35 971,-

A-3

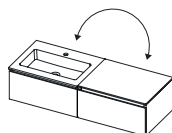

Rozměr nábytku (d x h x v)	Rozměr umyvadla (d x h x v)	Počet otvorů na baterie	Umístění umyvadla	Barva umyvadla	Umístění vyřezu v zásuvce na sifon	Obj. č. nábytku bezúchytková černá	Cena
120 x 45,5 x 28	60,3 x 46 x 1,3	1				F006052CODE	39 042,-/47 241,-
160 x 45,5 x 28	80,3 x 46 x 1,3	1				F006056CODE	42 715,-/51 685,-

A-4

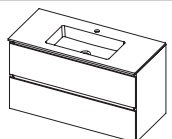

Rozměr nábytku (d x h x v)	Rozměr umyvadla (d x h x v)	Počet otvorů na baterie	Umístění umyvadla	Barva umyvadla	Umístění vyřezu v zásuvce na sifon	Obj. č. nábytku bezúchytková černá	Cena
60 x 45,5 x 56	60,3 x 46 x 1,3	1				F006001CODE	29 784,-/36 039,-
80 x 45,5 x 56	80,3 x 46 x 1,3	1				F006002CODE	33 076,-/40 022,-
100 x 45,5 x 56	100,3 x 46 x 1,3	1				F006066CODE	36 952,-/44 712,-
100 x 45,5 x 56	100,3 x 46 x 1,3	1				F006003CODE	36 952,-/44 712,-
100 x 45,5 x 56	100,3 x 46 x 1,3	1				F006070CODE	36 952,-/44 712,-
120 x 45,5 x 56	120,3 x 46 x 1,3	2				F006004CODE	45 086,-/54 554,-

A-5

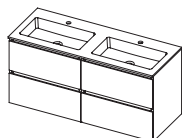

Rozměr nábytku (d x h x v)	Rozměr umyvadla (d x h x v)	Počet otvorů na baterie	Umístění umyvadla	Barva umyvadla	Umístění vyřezu v zásuvce na sifon	Obj. č. nábytku bezúchytková černá	Cena
120 x 45,5 x 56	120,3 x 46 x 1,3	2				F006076CODE	58 838,-/71 194,-
140 x 45,5 x 56	140,3 x 46 x 1,3	2				F006080CODE	62 545,-/75 679,-

A-6

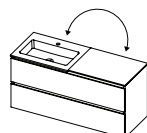

Rozměr nábytku (d x h x v)	Rozměr umyvadla (d x h x v)	Počet otvorů na baterie	Umístění umyvadla	Barva umyvadla	Umístění vyřezu v zásuvce na sifon	Obj. č. nábytku bezúchytková černá	Cena
120 x 45,5 x 56	60,3 x 46 x 1,3	1				F006135CODE	37 154,-/44 956,-
120 x 45,5 x 56	60,3 x 46 x 1,3	1				F006136CODE	37 154,-/44 956,-

A-6

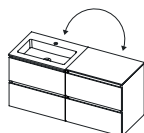

Rozměr nábytku (d x h x v)	Rozměr umyvadla (d x h x v)	Počet otvorů na baterie	Umístění umyvadla	Barva umyvadla	Umístění vyřezu v zásuvce na sifon	Obj. č. nábytku bezúchytková černá	Cena
120 x 45,5 x 56	60,3 x 46 x 1,3	1				F006084CODE	50 423,-/61 012,-
160 x 45,5 x 56	80,3 x 46 x 1,3	1				F006088CODE	55 333,-/66 953,-

A-7

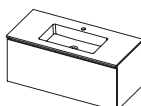

Rozměr nábytku (d x h x v)	Rozměr umyvadla (d x h x v)	Počet otvorů na baterie	Umístění umyvadla	Barva umyvadla	Umístění vyřezu v zásuvce na sifon	Obj. č. nábytku bezúchytková černá	Cena
60 x 45.50 x 42	60.3 x 46 x 1.3	1				F006157CODE	22 717,-/27 488,-
80 x 45.50 x 42	80.3 x 46 x 1.3	1				F006158CODE	25 571,-/30 941,-
100 x 45.50 x 42	100.3 x 46 x 1.3	1				F006159CODE	29 121,-/35 236,-
100 x 45.50 x 42	100.3 x 46 x 1.3	1				F006160CODE	29 121,-/35 236,-
100 x 45.50 x 42	100.3 x 46 x 1.3	1				F006161CODE	29 121,-/35 236,-
120 x 45.50 x 42	120.3 x 46 x 1.3	1				F006162CODE	33 817,-/40 919,-

A-8

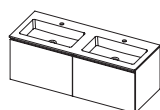

Rozměr nábytku (d x h x v)	Rozměr umyvadla (d x h x v)	Počet otvorů na baterie	Umístění umyvadla	Barva umyvadla	Umístění vyřezu v zásuvce na sifon	Obj. č. nábytku bezúchytková černá	Cena
120 x 45.50 x 42	120.3 x 46 x 1.3	2				F006163CODE	45 929,-/55 574,-
140 x 45.50 x 42	140.3 x 46 x 1.3	2				F006164CODE	47 244,-/57 165,-

A-9

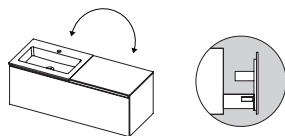

Rozměr nábytku (d x h x v)	Rozměr umyvadla (d x h x v)	Počet otvorů na baterie	Umístění umyvadla	Barva umyvadla	Umístění vyřezu v zásuvce na sifon	Obj. č. nábytku be- zúchytková černá	Cena
120 x 45.50 x 42	60.3 x 46 x 1.3	1				F006165CODE	27 413,-/33 170,-
120 x 45.50 x 42	60.3 x 46 x 1.3	1				F006166CODE	37 176,-/44 983,-

A-9

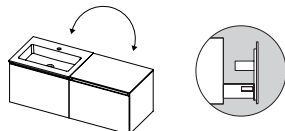

Rozměr nábytku (d x h x v)	Rozměr umyvadla (d x h x v)	Počet otvorů na baterie	Umístění umyvadla	Barva umyvadla	Umístění vyřezu v zásuvce na sifon	Obj. č. nábytku be- zúchytková černá	Cena
160 x 45.50 x 42	80.3 x 46 x 1.3	1				F006167CODE	41 367,-/50 054,-

B-4

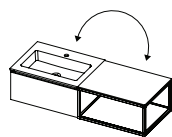

Rozměr nábytku (d x h x v)	Rozměr umyvadla (d x h x v)	Počet otvorů na baterie	Umístění umyvadla	Barva umyvadla	Umístění vyřezu v zásuvce na sifon	Obj. č. nábytku bezúchytková černá	Cena
120 x 45,5 x 28	60,3 x 46 x 1,3	1				F006092CODE	36 076,-/43 652,-
160 x 45,5 x 28	80,3 x 46 x 1,3	1				F006096CODE	39 480,-/47 771,-

B-5

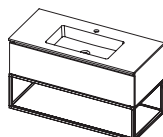

Rozměr nábytku (d x h x v)	Rozměr umyvadla (d x h x v)	Počet otvorů na baterie	Umístění umyvadla	Barva umyvadla	Umístění vyřezu v zásuvce na sifon	Obj. č. nábytku bezúchytková černá	Cena
60 x 45,5 x 56	60,3 x 46 x 1,3	1				F006009CODE	34 200,-/41 382,-
80 x 45,5 x 56	80,3 x 46 x 1,3	1				F006010CODE	37 312,-/45 148,-
100 x 45,5 x 56	100,3 x 46 x 1,3	1				F006011CODE	41 177,-/49 824,-
100 x 45,5 x 56	100,3 x 46 x 1,3	1				F006106CODE	41 165,-/49 810,-
100 x 45,5 x 56	100,3 x 46 x 1,3	1				F006110CODE	41 165,-/49 810,-

B-6

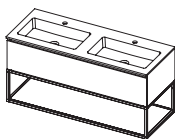

Rozměr nábytku (d x h x v)	Rozměr umyvadla (d x h x v)	Počet otvorů na baterie	Umístění umyvadla	Barva umyvad- la	Umístění vyřezu v zásuvce na sifon	Obj. č. nábytku bezúchytková černá	Cena
120 x 45,5 x 56	120,3 x 46 x 1,3	2				F006012CODE	49 558,-/59 965,-

B-6

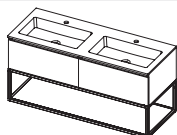

Rozměr nábytku (d x h x v)	Rozměr umyvadla (d x h x v)	Počet otvorů na baterie	Umístění umyvadla	Barva umyvad- la	Umístění vyřezu v zásuvce na sifon	Obj. č. nábytku bezúchytková černá	Cena
120 x 45,5 x 56	120,3 x 46 x 1,3	2				F006116CODE	59 354,-/71 818,-

B-7

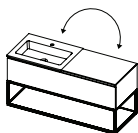

Rozměr nábytku (d x h x v)	Rozměr umyvadla (d x h x v)	Počet otvorů na baterie	Umístění umyvadla	Barva umyvad- la	Umístění vyřezu v zásuvce na sifon	Obj. č. nábytku bezúchytková černá	Cena
120 x 45,5 x 56	60,3 x 46 x 1,3	1				F006145CODE	41 581,-/50 313,-
120 x 45,5 x 56	60,3 x 46 x 1,3	1				F006146CODE	41 581,-/50 313,-

B-7

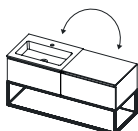

Rozměr nábytku (d x h x v)	Rozměr umyvadla (d x h x v)	Počet otvorů na baterie	Umístění umyvadla	Barva umyvad- la	Umístění vyřezu v zásuvce na sifon	Obj. č. nábytku bezúchytková černá	Cena
120 x 45,5 x 56	60,3 x 46 x 1,3	1				F006121CODE	51 939,-/62 846,-

B-8

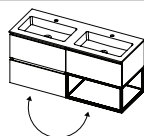

Rozměr nábytku (d x h x v)	Rozměr umyvadla (d x h x v)	Počet otvorů na baterie	Umístění umyvadla	Barva umyvad- la	Umístění vyřezu v zásuvce na sifon	Obj. č. nábytku bezúchytková černá	Cena
120 x 45,5 x 56	120,3 x 46 x 1,3	2				F006013CODE	60 927,-/73 722,-
140 x 45,5 x 56	140,3 x 46 x 1,3	0				F006151CODE	66 939,-/80 996,-





STONE TOP

PŘÍRODNÍ VZHLED

Nábytková řada Livit STONE TOP má přirozený vzhled a využívá praktické možnosti syntetického materiálu. Umyvadlo je vyrobeno ze syntetické pryskyřice, přesto má vzhled břidlicové struktury. Leštěné vnitřní strany umyvadla vytváří dokonalý kontrast se strukturovaným povrchem horní plochy umyvadla. Tento výrobek umístěný ve vaší koupelně na sebe zcela jistě připoutá pozornost.

Syntetická pryskyřice

Syntetický, robustní, odolný vůči všem vlivům používání i vůči vodním usazeninám. Umyvadlo se snadno udržuje hygienicky čistě. Pryskyřice je vysoce odolná vůči všem prostředkům, které v koupelně běžně používáte.

Něco navíc

Protože umyvadlo STONE TOP je vyráběno s vysokým okrajem, může být zavěšeno na stěně nebo může být doplněno spodními skříňkami dle vašeho výběru. V délce 100 cm může být umístěno na střed dolních skříňek.

LIVIT STONE TOP

Umyvadlo je vyrobeno z polyuretanové pryskyřice

- Černá barva s břidlicovou strukturou
- Vnitřek umyvadla je hladký,
- horní plocha umyvadla je břidlicové struktury
- Výška umyvadla: 12 cm
- Hloubka umyvadla: 9 cm
- Prostor v zásuvkách není omezen
- Bezpřepadové provedení
- Můžete si objednat bílý nebo černý neuzavíratelný CLIC-CLAC
- Doporučená teplota vody max. 65 ° C

Všechny koupelnové nábytky z řady Livit jsou nabízeny v těchto barevných odstínech:

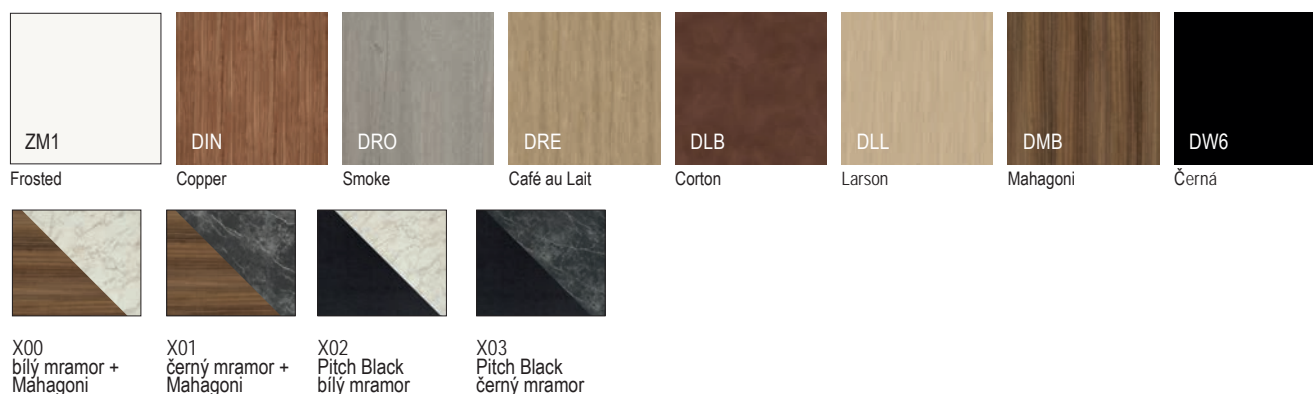

Umyvadlo je vyrobeno z polyuretanové pryskyřice, matná černá barva s břidlicovou strukturou

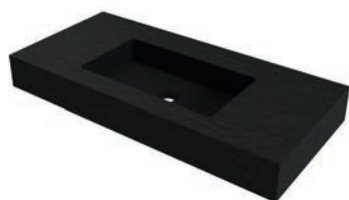

60,3 x 46 x 12 cm



80,3 x 46 x 12 cm



100,3 x 46 x 12 cm



100,3 x 46 x 12 cm



100,3 x 46 x 12 cm



120,3 x 46 x 12 cm



140,3 x 46 x 12 cm

Sety nábytku s umyvadly Livit Stone Top

Set A

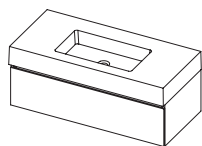

A-1

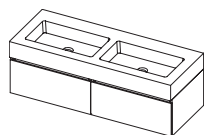

A-2

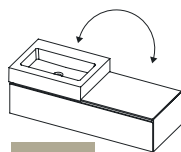

A-3

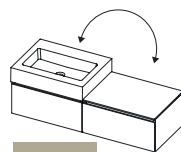

A-3



A-4

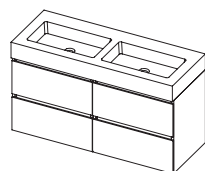

A-5

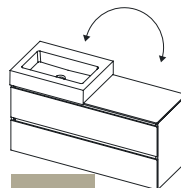

A-6

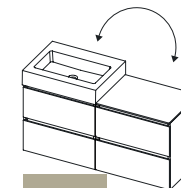

A-6

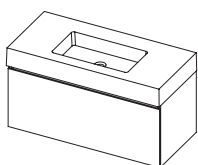

A-7

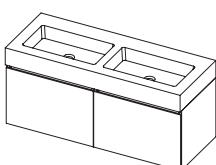

A-8

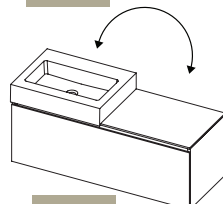

A-9

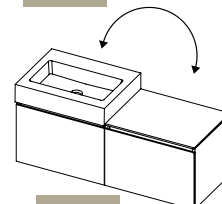

A-9

Set B

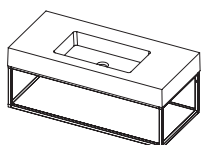

B-1

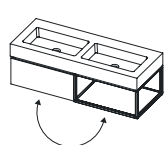

B-2

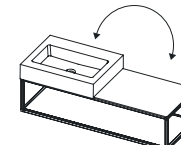

B-3

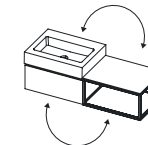

B-4

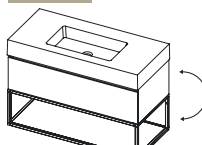

B-5

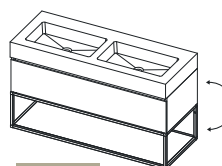

B-6

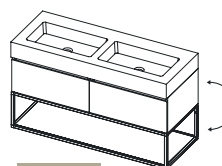

B-6

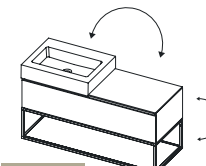

B-7

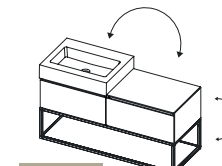

B-7

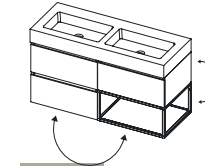

B-8

Set C

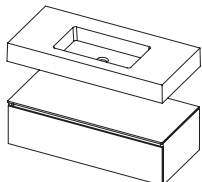

C-1

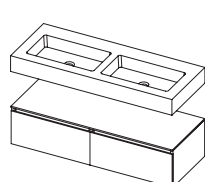

C-2

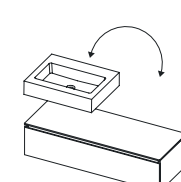

C-3

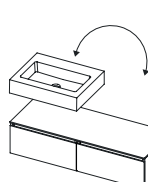

C-3

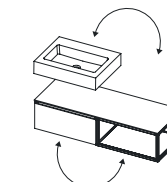

C-4

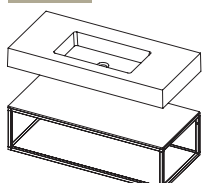

C-5

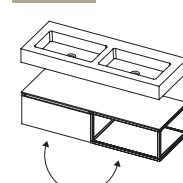

C-6

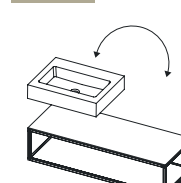

C-7

A-1

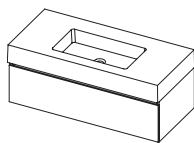

Rozměr nábytku (d x h x v)	Rozměr umyvadla (d x h x v)	Počet otvorů na baterie	Umístění umyvadla	Barva umyvadla	Umístění výřezu v zásuvce na sifon	Obj. č. nábytku bezúchytková černá	Cena
60 x 45,5 x 28	60,3 x 46 x 12	0	v	■	□	F005002CODE	30 301,-/36 664,-
80 x 45,5 x 28	80,3 x 46 x 12	0	□	■	□	F005006CODE	33 447,-/40 471,-
100 x 45,5 x 28	100,3 x 46 x 12	0	□	■	□	F005014CODE	36 716,-/44 426,-
100 x 45,5 x 28	100,3 x 46 x 12	0	□	■	□	F005010CODE	36 716,-/44 426,-
100 x 45,5 x 28	100,3 x 46 x 12	0	□	■	□	F005018CODE	36 716,-/44 426,-
120 x 45,5 x 28	120,3 x 46 x 12	0	□	■	□	F005022CODE	48 378,-/58 537,-

A-2

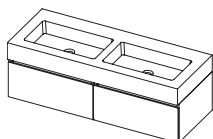

Rozměr nábytku (d x h x v)	Rozměr umyvadla (d x h x v)	Počet otvorů na baterie	Umístění umyvadla	Barva umyvadla	Umístění výřezu v zásuvce na sifon	Obj. č. nábytku bezúchytková černá	Cena
120 x 45,5 x 28	120,3 x 46 x 12	0	□	■	□	F005026CODE	58 321,-/70 568,-
140 x 45,5 x 28	140,3 x 46 x 12	0	□	■	□	F005030CODE	62 871,-/76 074,-

A-3

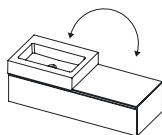

Rozměr nábytku (d x h x v)	Rozměr umyvadla (d x h x v)	Počet otvorů na baterie	Umístění umyvadla	Barva umyvadla	Umístění výřezu v zásuvce na sifon	Obj. č. nábytku bezúchytková černá	Cena
120 x 45,5 x 28	60,3 x 46 x 12	0	□	■	□	F005035CODE	36 334,-/43 964,-

A-3

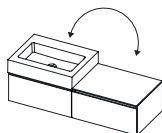

Rozměr nábytku (d x h x v)	Rozměr umyvadla (d x h x v)	Počet otvorů na baterie	Umístění umyvadla	Barva umyvadla	Umístění výřezu v zásuvce na sifon	Obj. č. nábytku bezúchytková černá	Cena
120 x 45,5 x 28	60,3 x 46 x 12	0	□	■	□	F005036CODE	45 232,-/54 731,-
160 x 45,5 x 28	80,3 x 46 x 12	0	□	■	□	F005042CODE	49 400,-/59 774,-

A-4



Rozměr nábytku (d x h x v)	Rozměr umyvadla (d x h x v)	Počet otvorů na baterie	Umístění umyvadla	Barva umyvadla	Umístění výřezu v zásuvce na sifon	Obj. č. nábytku bezúchytková černá	Cena
60 x 45,5 x 56	60,3 x 46 x 12	0	□	■	□	F005046CODE	36 009,-/43 571,-
80 x 45,5 x 56	80,3 x 46 x 12	0	□	■	□	F005050CODE	39 750,-/48 098,-
100 x 45,5 x 56	100,3 x 46 x 12	0	□	■	□	F005058CODE	43 525,-/52 665,-
100 x 45,5 x 56	100,3 x 46 x 12	0	□	■	□	F005054CODE	43 525,-/52 665,-
100 x 45,5 x 56	100,3 x 46 x 12	0	□	■	□	F005062CODE	43 525,-/52 665,-
120 x 45,5 x 56	120,3 x 46 x 12	0	□	■	□	F005066CODE	55 838,-/67 564,-

A-5

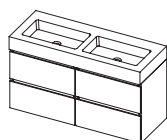

Rozměr nábytku (d x h x v)	Rozměr umyvadla (d x h x v)	Počet otvorů na baterie	Umístění umyvadla	Barva umyvadla	Umístění vyřezu v zásuvce na sifon	Obj. č. nábytku bezúchytková černá	Cena
120 x 45,5 x 56	120,3 x 46 x 12	0				F005070CODE	69 714,-/84 354,-
140 x 45,5 x 56	140,3 x 46 x 12	0				F005074CODE	75 420,-/91 258,-

A-6

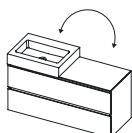

Rozměr nábytku (d x h x v)	Rozměr umyvadla (d x h x v)	Počet otvorů na baterie	Umístění umyvadla	Barva umyvadla	Umístění vyřezu v zásuvce na sifon	Obj. č. nábytku bezúchytková černá	Cena
120 x 45,5 x 56	60,3 x 46 x 12	0				F005079CODE	43 794,-/52 991,-

A-6

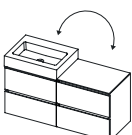

Rozměr nábytku (d x h x v)	Rozměr umyvadla (d x h x v)	Počet otvorů na baterie	Umístění umyvadla	Barva umyvadla	Umístění vyřezu v zásuvce na sifon	Obj. č. nábytku bezúchytková černá	Cena
120 x 45,5 x 56	60,3 x 46 x 12	0				F005080CODE	56 636,-/68 530,-
160 x 45,5 x 56	80,3 x 46 x 12	0				F005086CODE	62 029,-/75 055,-

A-7

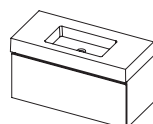

Rozměr nábytku (d x h x v)	Rozměr umyvadla (d x h x v)	Počet otvorů na baterie	Umístění umyvadla	Barva umyvadla	Umístění vyřezu v zásuvce na sifon	Obj. č. nábytku be- zúchytková černá	Cena
60 x 45.50 x 42	60.3 x 46 x 12	0				F005233CODE	29 166,-/35 291,-
80 x 45.50 x 42	80.3 x 46 x 12	0				F005234CODE	32 548,-/39 383,-
100 x 45.50 x 42	100.3 x 46 x 12	0				F005235CODE	35 964,-/43 516,-
100 x 45.50 x 42	100.3 x 46 x 12	0				F005236CODE	35 964,-/43 516,-
100 x 45.50 x 42	100.3 x 46 x 12	0				F005237CODE	35 964,-/43 516,-
120 x 45.50 x 42	120.3 x 46 x 12	0				F005238CODE	45 266,-/54 772,-

A-8

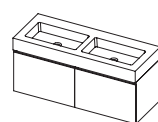

Rozměr nábytku (d x h x v)	Rozměr umyvadla (d x h x v)	Počet otvorů na baterie	Umístění umyvadla	Barva umyvadla	Umístění vyřezu v zásuvce na sifon	Obj. č. nábytku be- zúchytková černá	Cena
120 x 45.50 x 42	120.3 x 46 x 12	0				F005239CODE	55 029,-/66 585,-
140 x 45.50 x 42	140.3 x 46 x 12	0				F005240CODE	60 669,-/73 409,-

A-9

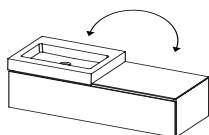

Rozměr nábytku (d x h x v)	Rozměr umyvadla (d x h x v)	Počet otvorů na baterie	Umístění umyvadla	Barva umyvadla	Umístění výřezu v zásuvce na sifon	Obj. č. nábytku be- zúchytková černá	Cena
120 x 45,50 x 42	60,3 x 46 x 12	0				F005241CODE	33 863,-/40 974,-

A-9

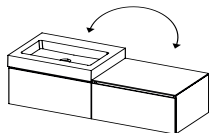

Rozměr nábytku (d x h x v)	Rozměr umyvadla (d x h x v)	Počet otvorů na baterie	Umístění umyvadla	Barva umyvadla	Umístění výřezu v zásuvce na sifon	Obj. č. nábytku be- zúchytková černá	Cena
120 x 45,50 x 42	60,3 x 46 x 12	0				F005242CODE	43 625,-/52 786,-
160 x 45,50 x 42	80,3 x 46 x 12	0				F005243CODE	48 344,-/58 496,-

B-1

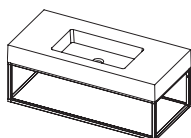

Rozměr nábytku (d x h x v)	Rozměr umyvadla (d x h x v)	Počet otvorů na baterie	Umístění umyvadla	Barva umyvadla	Umístění výřezu v zásuvce na sifon	Rám Buddy černá	Cena
60 x 45,5 x 28	60,3 x 46 x 12	0				F005090CODE	27 335,-/33 075,-
80 x 45,5 x 28	80,3 x 46 x 12	0				F005092CODE	30 211,-/36 555,-
100 x 45,5 x 28	100,3 x 46 x 12	0				F005094CODE	33 076,-/40 022,-
100 x 45,5 x 28	100,3 x 46 x 12	0				F005096CODE	33 076,-/40 022,-
100 x 45,5 x 28	100,3 x 46 x 12	0				F005098CODE	33 076,-/40 022,-
120 x 45,5 x 28	120,3 x 46 x 12	0				F005100CODE	44 086,-/53 344,-

B-2

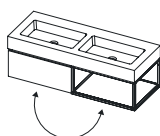

Rozměr nábytku (d x h x v)	Rozměr umyvadla (d x h x v)	Počet otvorů na baterie	Umístění umyvadla	Barva umyvadla	Umístění výřezu v zásuvce na sifon	Obj. č. nábytku bezúchytková černá	Cena
120 x 45,5 x 28	120,3 x 46 x 12	0				F005102CODE	55 343,-/66 965,-
140 x 45,5 x 28	140,3 x 46 x 12	0				F005106CODE	60 062,-/72 675,-

B-3

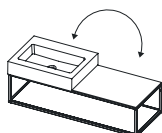

Rozměr nábytku (d x h x v)	Rozměr umyvadla (d x h x v)	Počet otvorů na baterie	Umístění umyvadla	Barva umyvadla	Umístění výřezu v zásuvce na sifon	Rám Buddy černá	Cena
120x 45,5 x 28	60,3 x 46 x 12	0				F005110CODE	32 042,-/38 771,-

B-4

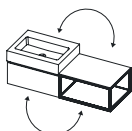

Rozměr nábytku (d x h x v)	Rozměr umyvadla (d x h x v)	Počet otvorů na baterie	Umístění umyvadla	Barva umyvadla	Umístění vyřezu v zásuvce na sifon	Obj. č. nábytku bezúchytková černá	Cena
120 x 45,5 x 28	60,3 x 46 x 12	0				F005112CODE	42 266,-/51 142,-
160 x 45,5 x 28	80,3 x 46 x 12	0				F005116CODE	46 164,-/55 858,-

B-5



Rozměr nábytku (d x h x v)	Rozměr umyvadla (d x h x v)	Počet otvorů na baterie	Umístění umyvadla	Barva umyvadla	Umístění vyřezu v zásuvce na sifon	Obj. č. nábytku bezúchytková černá	Cena
60 x 45,5 x 56	60,3 x 46 x 12	0				F005120CODE	40 379,-/48 859,-
80 x 45,5 x 56	80,3 x 46 x 12	0				F005124CODE	43 996,-/53 235,-
100 x 45,5 x 56	100,3 x 46 x 12	0				F005128CODE	47 749,-/57 776,-
100 x 45,5 x 56	100,3 x 46 x 12	0				F005132CODE	47 749,-/57 776,-
100 x 45,5 x 56	100,3 x 46 x 12	0				F005136CODE	47 749,-/57 776,-

B-6

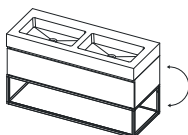

Rozměr nábytku (d x h x v)	Rozměr umyvadla (d x h x v)	Počet otvorů na baterie	Umístění umyvadla	Barva umyvadla	Umístění vyřezu v zásuvce na sifon	Obj. č. nábytku bezúchytková černá	Cena
140 x 45,5 x 56	140,3 x 46 x 12	0				F005140CODE	60 231,-/72 880,-

B-6

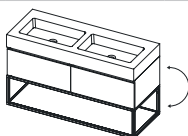

Rozměr nábytku (d x h x v)	Rozměr umyvadla (d x h x v)	Počet otvorů na baterie	Umístění umyvadla	Barva umyvadla	Umístění vyřezu v zásuvce na sifon	Obj. č. nábytku bezúchytková černá	Cena
120 x 45,5 x 56	120,3 x 46 x 12	0				F005144CODE	70 174,-/84 911,-

B-7

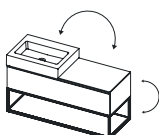

Rozměr nábytku (d x h x v)	Rozměr umyvadla (d x h x v)	Počet otvorů na baterie	Umístění umyvadla	Barva umyvadla	Umístění vyřezu v zásuvce na sifon	Obj. č. nábytku bezúchytková černá	Cena
120 x 45,5 x 56	60,3 x 46 x 12	0				F005151CODE	48 187,-/58 306,-

B-7

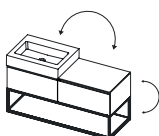

Rozměr nábytku (d x h x v)	Rozměr umyvadla (d x h x v)	Počet otvorů na baterie	Umístění umyvadla	Barva umyvadla	Umístění vyřezu v zásuvce na sifon	Obj. č. nábytku bezúchytková černá	Cena
120 x 45,5 x 56	60,3 x 46 x 12	0				F005152CODE	58 142,-/70 352,-

B-8

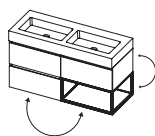

Rozměr nábytku (d x h x v)	Rozměr umyvadla (d x h x v)	Počet otvorů na baterie	Umístění umyvadla	Barva umyvadla	Umístění výřezu v zásuvce na sifon	Obj. č. nábytku bezúchytková černá	Cena
120 x 45,5 x 56	120,3 x 46 x 12	0				F005157CODE	74 084,-/89 642,-

C-1

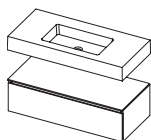

Rozměr nábytku (d x h x v)	Rozměr umyvadla (d x h x v)	Počet otvorů na baterie	Umístění umyvadla	Barva umyvadla	Umístění výřezu v zásuvce na sifon	Obj. č. nábytku bezúchytková černá	Cena
60 x 45,5 x 28	60,3 x 46 x 12	0				F005160CODE	32 189,-/38 949,-
80 x 45,5 x 28	80,3 x 46 x 12	0				F005164CODE	35 593,-/43 068,-
100 x 45,5 x 28	100,3 x 46 x 12	0				F005172CODE	39 155,-/47 378,-
100 x 45,5 x 28	100,3 x 46 x 12	0				F005168CODE	39 155,-/47 378,-
100 x 45,5 x 28	100,3 x 46 x 12	0				F005176CODE	39 155,-/47 378,-
120 x 45,5 x 28	120,3 x 46 x 12	0				F005180CODE	51 097,-/61 827,-

C-2

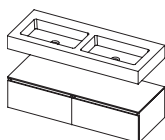

Rozměr nábytku (d x h x v)	Rozměr umyvadla (d x h x v)	Počet otvorů na baterie	Umístění umyvadla	Barva umyvadla	Umístění výřezu v zásuvce na sifon	Obj. č. nábytku bezúchytková černá	Cena
120 x 45,5 x 28	120,3 x 46 x 12	0				F005184CODE	61 040,-/73 858,-
140 x 45,5 x 28	140,3 x 46 x 12	0				F005188CODE	65 770,-/79 582,-

C-3

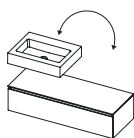

Rozměr nábytku (d x h x v)	Rozměr umyvadla (d x h x v)	Počet otvorů na baterie	Umístění umyvadla	Barva umyvadla	Umístění výřezu v zásuvce na sifon	Obj. č. nábytku bezúchytková černá	Cena
120 x 45,5 x 28	60,3 x 46 x 12	0				F005193CODE	37 188,-/44 997,-

C-3

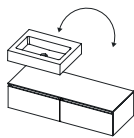

Rozměr nábytku (d x h x v)	Rozměr umyvadla (d x h x v)	Počet otvorů na baterie	Umístění umyvadla	Barva umyvadla	Umístění výřezu v zásuvce na sifon	Obj. č. nábytku bezúchytková černá	Cena
120 x 45,5 x 28	60,3 x 46 x 12	0				F005194CODE	47 120,-/57 015,-
160 x 45,5 x 28	80,3 x 46 x 12	0				F005200CODE	51 478,-/62 288,-

C-4

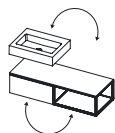

Rozměr nábytku (d x h x v)	Rozměr umyvadla (d x h x v)	Počet otvorů na baterie	Umístění umyvadla	Barva umyvadla	Umístění vyřezu v zásuvce na sifon	Obj. č. nábytku bezúchytková černá	Cena
120 x 45,5 x 28	60,3 x 46 x 12	0				F005204CODE	44 154,-/53 426,-
160 x 45,5 x 28	80,3 x 46 x 12	0				F005208CODE	48 255,-/58 389,-

C-5

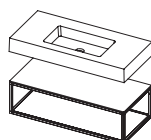

Rozměr nábytku (d x h x v)	Rozměr umyvadla (d x h x v)	Počet otvorů na baterie	Umístění umyvadla	Barva umyvadla	Umístění vyřezu v zásuvce na sifon	Rám Buddy černá	Cena
60 x 45,5 x 28	60,3 x 46 x 12	0				F005212CODE	29 223,-/35 360,-
80 x 45,5 x 28	80,3 x 46 x 12	0				F005214CODE	32 379,-/39 179,-
100 x 45,5 x 28	100,3 x 46 x 12	0				F005216CODE	35 514,-/42 972,-
100 x 45,5 x 28	100,3 x 46 x 12	0				F005218CODE	35 514,-/42 972,-
100 x 45,5 x 28	100,3 x 46 x 12	0				F005220CODE	35 514,-/42 972,-
120 x 45,5 x 28	120,3 x 46 x 12	0				F005222CODE	46 805,-/56 634,-

C-6

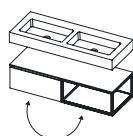

Rozměr nábytku (d x h x v)	Rozměr umyvadla (d x h x v)	Počet otvorů na baterie	Umístění umyvadla	Barva umyvadla	Umístění vyřezu v zásuvce na sifon	Obj. č. nábytku bezúchytková černá	Cena
120 x 45,5 x 28	120,3 x 46 x 12	0				F005224CODE	58 073,-/70 268,-
140 x 45,5 x 28	140,3 x 46 x 12	0				F005228CODE	62 961,-/76 183,-

C-7

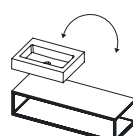

Rozměr nábytku (d x h x v)	Rozměr umyvadla (d x h x v)	Počet otvorů na baterie	Umístění umyvadla	Barva umyvadla	Umístění vyřezu v zásuvce na sifon	Rám Buddy černá	Cena
120 x 45,5 x 28	120 x 46 x 12	0				F005232CODE	32 897,-/39 805,-

RIHO

NÁBYTEK





UMYVADLA S MRAMOROVÝM POVRCHEM

Koupelnový nábytek LIVIT s keramickými umyvadly

Mramorová umyvadla LIVIT jsou k dispozici v kulatém, oválném a obdélníkovém provedení.

Umyvadla mají elegantní vzhled a jsou snadná na údržbu.

Tato umyvadla je zapotřebí objednat samostatně.

Materiál

Umyvadla jsou vyrobena z keramiky. Keramika je dlouhodobě snadno udržitelný materiál, který je vhodný pro používání všech kosmetických a hygienických prostředků.

Barvy

Bílá a černá

UMYVADLA S MRAMOROVÝM POVRCHEM

- Keramické umyvadlo
- Bílá nebo černá barva
- Kulatý, oválný nebo obdélníkový tvar
- Není nutný výřez zásuvky
- Bez přepadové provedení

Všechny koupelnové nábytky z řady Livit jsou nabízeny v těchto barevných odstínech:

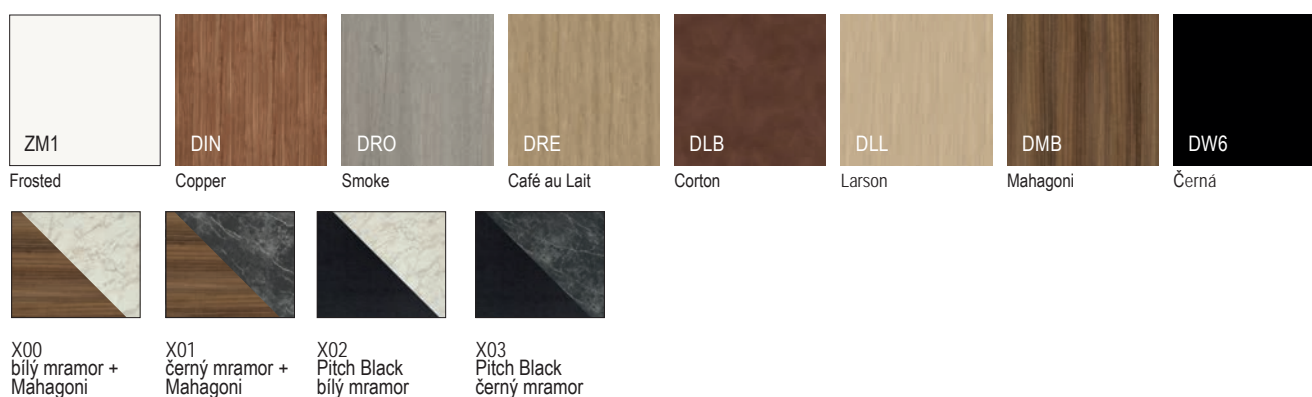

Ø 34,6 x 11,5 cm



52 x 39,5 x 13 cm



50 x 39 x 13 cm



SPODNÍ SKŘÍŇKY S KRYCÍMI DESKAMI LIVIT

Součástí dodávky je krycí deska vyrobená ve stejném dekoru dřeva jako spodní skříňky.

Set A

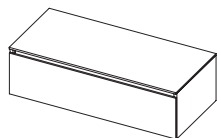

A-1

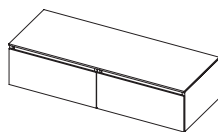

A-2

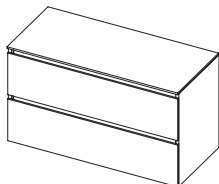

A-4

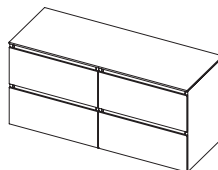

A-5

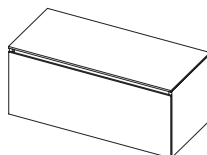

A-7

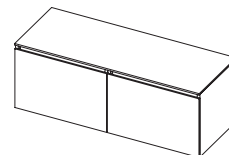

A-8

Set B

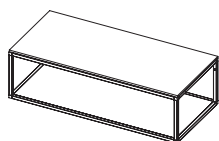

B-1

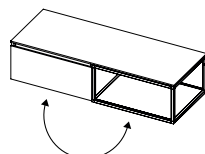

B-2

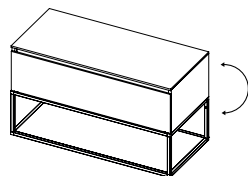

B-5

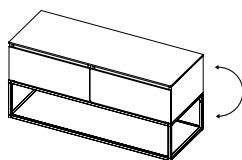

B-6

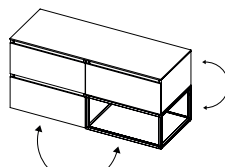

B-8

Set C

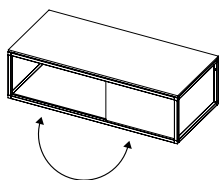

C-1

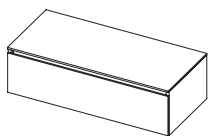
A-1

Rozměr nábytku (d x h x v)	Umístění vyřezu v zásuvce na sifon	Obj. č. nábytku be- zúchytková černá	Cena
60 x 46 x 29		F007002CODE	14 931,-/18 067,-
80 x 46 x 29		F007006CODE	15 954,-/19 304,-
100 x 46 x 29		F007010CODE	17 122,-/20 718,-
120 x 46 x 29		F007096CODE	19 920,-/24 103,-

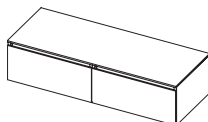
A-2

Rozměr nábytku (d x h x v)	Umístění vyřezu v zásuvce na sifon	Obj. č. nábytku be- zúchytková černá	Cena
120 x 46 x 29		F007014CODE	29 863,-/36 134,-
140 x 46 x 29		F007018CODE	30 301,-/36 664,-
160 x 46 x 29		F007022CODE	31 829,-/38 513,-

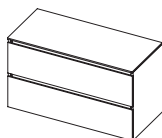
A-4

Rozměr nábytku (d x h x v)	Umístění vyřezu v zásuvce na sifon	Obj. č. nábytku be- zúchytková černá	Cena
60 x 46 x 57		F007026CODE	20 627,-/24 959,-
80 x 46 x 57		F007030CODE	22 279,-/26 958,-
100 x 46 x 57		F007034CODE	23 931,-/28 957,-
120 x 46 x 57		F007100CODE	27 380,-/33 130,-

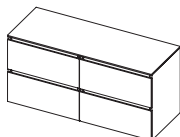
A-5

Rozměr nábytku (d x h x v)	Umístění vyřezu v zásuvce na sifon	Obj. č. nábytku be- zúchytková černá	Cena
120 x 46 x 57		F007038CODE	41 255,-/49 919,-
140 x 46 x 57		F007042CODE	42 862,-/51 863,-
160 x 46 x 57		F007046CODE	44 479,-/53 820,-

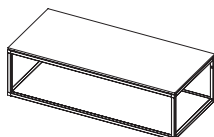
B-1

Rozměr nábytku (d x h x v)	Umístění vyřezu v zásuvce na sifon	Rám Buddy černá	Cena
60 x 46 x 29		F007050CODE	11 966,-/14 479,-
100 x 46 x 29		F007054CODE	13 470,-/16 299,-
120 x 46 x 29		F007104CODE	15 628,-/18 910,-

A-7

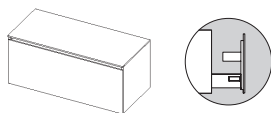

Rozměr nábytku (d x h x v)	Umístění vyřezu v zásuvce na sifon	Obj. č. nábytku be- zúchytková černá	Cena
60 x 45.50 x 42		F007109CODE	14 471,-/17 510,-
80 x 45.50 x 42		F007110CODE	15 808,-/19 128,-
100 x 45.50 x 42		F007111CODE	17 168,-/20 773,-
120 x 45.50 x 42		F007112CODE	17 369,-/21 016,-

A-8

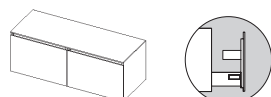

Rozměr nábytku (d x h x v)	Umístění vyřezu v zásuvce na sifon	Obj. č. nábytku be- zúchytková černá	Cena
120 x 45.50 x 42		F007113CODE	28 009,-/33 891,-
140 x 45.50 x 42		F007114CODE	29 537,-/35 740,-
160 x 45.50 x 42		F007115CODE	30 480,-/36 881,-

B-2

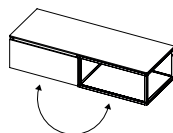

Rozměr nábytku (d x h x v)	Umístění vyřezu v zásuvce na sifon	Obj. č. nábytku bezúchytková černá	Cena
120 x 46 x 29		F007058CODE	26 897,-/32 545,-
140 x 46 x 29		F007062CODE	27 481,-/33 252,-
160 x 46 x 29		F007066CODE	28 616,-/34 625,-

B-5

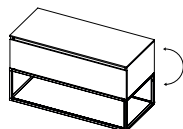

Rozměr nábytku (d x h x v)	Umístění vyřezu v zásuvce na sifon	Obj. č. nábytku be- zúchytková černá	Cena
60 x 46 x 57		F007070CODE	25 009,-/30 261,-
80 x 46 x 57		F007074CODE	26 515,-/32 083,-
100 x 46 x 57		F007078CODE	28 155,-/34 068,-
120 x 46 x 57		F007106CODE	31 773,-/38 445,-

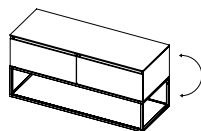
B-6

Rozměr nábytku
(d x h x v)

Umístění
vyřezu v
zásuvce na
sifon

Obj. č. nábytku be-
zúchytková černá

Cena

120 x 46 x 57



F007082CODE

41 715,-/50 475,-

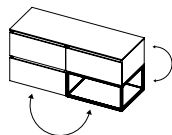
B-8

Rozměr nábytku
(d x h x v)

Umístění
vyřezu v
zásuvce na
sifon

Obj. č. nábytku be-
zúchytková černá

Cena

120 x 46 x 57



F007086CODE

43 463,-/52 590,-

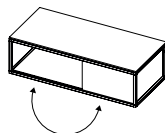
C-1

Rozměr nábytku
(d x h x v)

Umístění
vyřezu v
zásuvce na
sifon

Rám Buddy černá
Cena

80 x 46 x 29



F007090CODE

21 414,-/25 911,-

100 x 46 x 29



F007092CODE

22 167,-/26 822,-

120 x 46 x 29



F007094CODE

24 290,-/29 391,-



UMYVADLO TINY

Keramické umyvadlo TINY je ideální trendové řešení pro vaši toaletu v kombinaci s užitnými vlastnostmi a úložným prostorem. V kombinaci s RÁMEM TINY je také praktický i estetický. Sám název napovídá, že TINY SKŘÍŇKY mohou sloužit k uschování ručníku či jiných nezbytností. Designový nábytek je vám k dispozici ve všech osmi módních barvách Livit s nimiž můžete vytvářet zábavné sestavy nábytku.

TINY WASH

Umyvadlo vyrobené z keramiky

- Lesklá bílá barva
- Výška umyvadla: 10 cm
- Hloubka umyvadla: 8,5 cm
- 1 otvor na baterii - hloubka 40 cm
- Můžete si objednat bílý nebo černý neuzavíratelný CLIC-CLAC

TINY UMYVADLO je k dispozici pouze v jednom rozměru, v levém a pravém provedení, je vyrobeno z keramiky.



20,5 x 41 x 10,5 cm



20,5 x 41 x 10,5 cm

Všechny koupelnové nábytky z řady Livit jsou nabízeny v těchto barevných odstínech:



Sety nábytku s umyvadly Livit Tiny

Set A

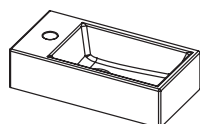

A-1

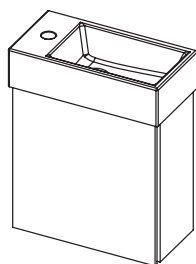

A-2

Set B

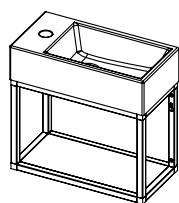

B-1

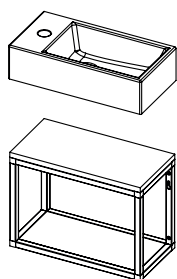

B-2

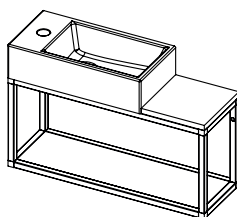

B-3

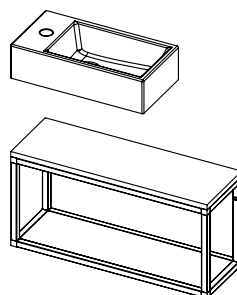

B-4

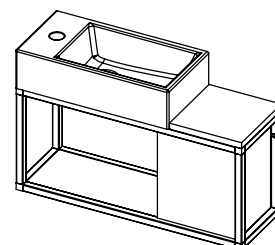

B-5



		umyvadlo			
SET A-1	umyvadlo		Obj. č.	Cena	
40 cm 		1	F0090020	4 236,-/5 126,-	
		1	F0090010		







		umyvadlo			
SET A-2	umyvadlo		Nábytková skříňka pravá	Nábytková skříňka levá	Cena
40 cm 		1	F009005CODE	F009006CODE	14 268,-/17 264,-
		1	F009003CODE	F009004CODE	



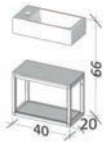



		umyvadlo		RÁM BUDDY	Cena
SET B-1	umyvadlo				
40 cm 		1	F009010CODE	11 292,-/13 663,-	
		1	F009008CODE		







		umyvadlo	RÁM BUDDY	Cena
40 cm	SET B-2	umyvadlo		
				
			1	F009014CODE
			1	F009012CODE
				12 426,-/15 035,-







		umyvadlo	RÁM BUDDY	Cena
40 cm	SET B-3	umyvadlo		
				
			1	F009018CODE
			1	F009016CODE
				13 078,-/15 824,-

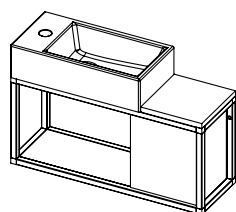

		umyvadlo	RÁM BUDDY	Cena
40 cm	SET B-4	umyvadlo		
				
			1	F009022CODE
			1	F009020CODE
				13 516,-/16 354,-

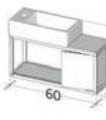

B-5

		umyvadlo	RÁM BUDDY	Cena
40 cm	SET B-5	umyvadlo		
				
			1	F009026CODE
			1	F009024CODE
				17 073,-/20 658,-



KOMBINOVATELNÉ PRVKY

Nemůžete váš vysněný nábytek najít v naší základní nabídce? Chcete si sestavit nábytek Livit zcela dle vašich představ nebo potřeb?









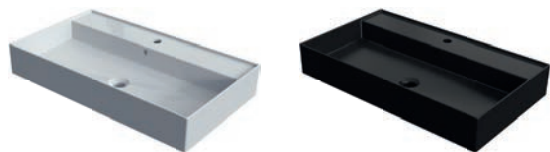

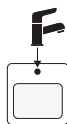

Objednejte si základní komponenty a sestavte si koupelnový nábytek dle vašeho vlastního návrhu.

Kombinujte umyvadla, spodní skříňky a zrcadla dle vašeho individuálního přání.



LIVIT GLAZE TOP



		Rozměry		Obj. č.	Cena
60 cm		61 x 46 x 12,5 cm	0	W006001005	10 112,-/12 236,-
	1		W006002005		
80 cm		61 x 46 x 12,5 cm	0	W006001304	13 695,-/16 571,-
	1		W006002304		
100 cm		81 x 46 x 12,5 cm	0	W006003005	12 741,-/15 417,-
	1		W006004005		
120 cm		81 x 46 x 12,5 cm	0	W006003304	17 156,-/20 759,-
	1		W006004304		
100 cm		101 x 46 x 12,5 cm	0	W006005005	15 358,-/18 583,-
	1		W006006005		
120 cm		101 x 46 x 12,5 cm	2	W006007005	20 617,-/24 947,-
	0		W006005304		
120 cm		101 x 46 x 12,5 cm	1	W006006304	20 617,-/24 947,-
	2		W006007304		
120 cm		121 x 46 x 12,5 cm	0	W006008005	18 830,-/22 784,-
	2		W006009005		
120 cm		121 x 46 x 12,5 cm	0	W006008304	25 492,-/30 845,-
	2		W006009304		
120 cm		121 x 46 x 12,5 cm	0	W006010005	20 020,-/24 224,-
	2		W006011005		
120 cm		121 x 46 x 12,5 cm	0	W006010304	27 167,-/32 872,-
	2		W006011304		







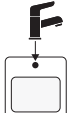

Umyvadla lze kombinovat s BUDDY RÁMEM umístěním přímo na sebe

V zásuvce není omezen prostor

Vhodné k zavěšení na stěnu

LIVIT VELVET SLIM



		Rozměry		Obj. č.	Cena
60 cm		60,5 x 46 x 1,25 cm	0 1	W007001105 W007002105	6 977,-/8 442,-
80 cm		80,5 x 46 x 1,25 cm	0 1	W007003105 W007004105	8 708,-/10 537,-
100 cm		100,5 x 46 x 1,25 cm	0 1	W007005105 W007006105	9 729,-/11 772,-
		120,5 x 46 x 1,25 cm	0 2	W007007105 W007008105	12 224,-/14 791,-
120 cm		120,5 x 46 x 1,25 cm	0 1	W007009105 W007010105	11 032,-/13 349,-
		120,5 x 46 x 1,25 cm	0 1	W007011105 W007012105	11 032,-/13 349,-
140 cm		140,5 x 46 x 1,25 cm	0 2	W007013105 W007014105	12 830,-/15 524,-
160 cm		160,5 x 46 x 1,25 cm	0 2	W007015105 W007016105	17 055,-/20 637,-







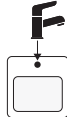

Umyvadla nelze kombinovat s BUDDY RÁMEM

Výřez na sifon v zásuvce

Nevhodné k zavěšení na stěnu

LIVIT VELVET TOP



		Rozměry		Obj. č.	Cena
60 cm		60,5 x 46 x 12 cm	0 1	W008001105 W008002105	10 920,-/13 213,-
80 cm		80,5 x 46 x 12 cm	0 1	W008003105 W008004105	13 179,-/15 947,-
100 cm		100,5 x 46 x 12 cm	0 1	W008005105 W008006105	14 606,-/17 673,-
		120,5 x 46 x 12 cm	0 2	W008007105 W008008105	17 706,-/21 424,-
120 cm		120,5 x 46 x 12 cm	0 1	W008009105 W008010105	16 515,-/19 983,-
		120,5 x 46 x 12 cm	0 1	W008011105 W008012105	16 515,-/19 983,-
140 cm		140,5 x 46 x 12 cm	0 2	W008013105 W008014105	18 954,-/22 934,-

Umyvadla lze kombinovat s BUDDY RÁMEM umístěním přímo na sebe

Výřez na sifon v zásuvce

Vhodné k zavěšení na stěnu

LIVIT STONE SLIM

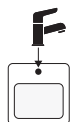

		Rozměry		Obj. č.	Cena
60 cm		60,3 x 46 x 1,3 cm	1	W009001304	9 550,-/11 556,-
80 cm		80,3 x 46 x 1,3 cm	1	W009002304	11 460,-/13 867,-
		100,3 x 46 x 1,3 cm	1	W009003304	13 953,-/16 883,-
100 cm		100,3 x 46 x 1,3 cm	1	W009006304	13 953,-/16 883,-
		100,3 x 46 x 1,3 cm	1	W009007304	13 953,-/16 883,-
120 cm		120,3 x 46 x 1,3 cm	2	W009004304	17 302,-/20 935,-
140 cm		140,3 x 46 x 1,3 cm	2	W009005304	19 695,-/23 831,-







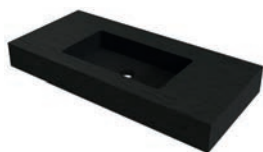

Umyvadla nelze kombinovat s BUDDY RÁMEM

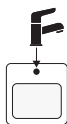
Výřez na sifon v zásuvce

Nevhodné k zavěšení na stěnu

LIVIT STONE TOP









		Rozměry		Obj. č.	Cena
60 cm		60,3 x 46 x 12 cm	0	W010001304	16 953,-/20 513,-
80 cm		80,3 x 46 x 12 cm	0	W010002304	18 493,-/22 377,-
		100,3 x 46 x 12 cm	0	W010003304	20 886,-/25 272,-
100 cm		100,3 x 46 x 12 cm	0	W010004304	20 886,-/25 272,-
		100,3 x 46 x 12 cm	0	W010005304	20 886,-/25 272,-
120 cm		120,3 x 46 x 12 cm	0	W010006304	28 874,-/34 938,-
140 cm		140,3 x 46 x 12 cm	0	W010007304	33 165,-/40 130,-

Umyvadla lze kombinovat s BUDDY RÁMEM umístěním přímo na sebe

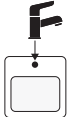
V zásuvce není omezen prostor

Vhodné k zavěšení na stěnu

UMYVADLA S MRAMOROVÝM POVRCHEM

	Rozměry		Obj. č.	Cena
	Ø 34,6 x 11,5 cm	0	W031002M00	3 865,-/4 677,-
	Ø 34,6 x 11,5 cm	0	W031002M01	3 865,-/4 677,-
	52 x 39,5 x 13 cm	0	W031001M00	4 573,-/5 533,-
	52 x 39,5 x 13 cm	0	W031001M01	4 573,-/5 533,-
	50 x 39 x 13 cm	0	W031003M00	4 528,-/5 479,-
	50 x 39 x 13 cm	0	W031003M01	4 528,-/5 479,-

V zásuvce není omezen prostor

Nevhodné k zavěšení na stěnu

LIVIT GLAZE TOP

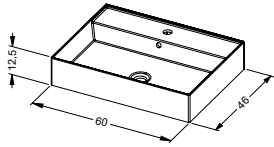

Livit Glaze Top - 60 cm

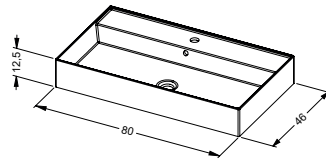

Livit Glaze Top - 80 cm

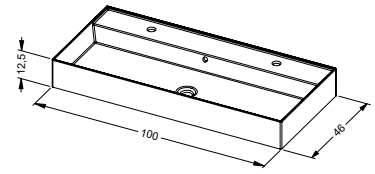

Livit Glaze Top - 100 cm

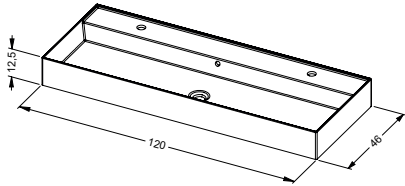

Livit Glaze Top - 120 cm

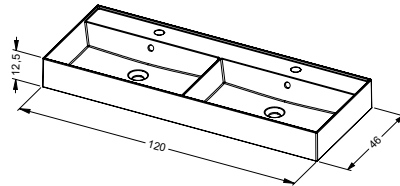

Livit Glaze Top - 120 cm

LIVIT VELVET SLIM

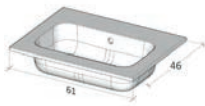

Livit Velvet Slim - 60 cm

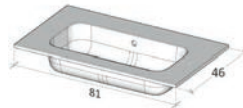

Livit Velvet Slim - 80 cm

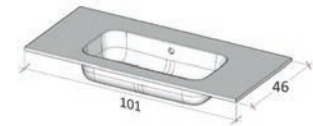

Livit Velvet Slim - 100 cm

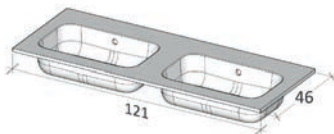

Livit Velvet Slim - 120 cm

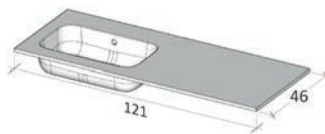

Livit Velvet Slim - 120 cm

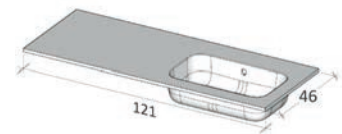

Livit Velvet Slim - 120 cm

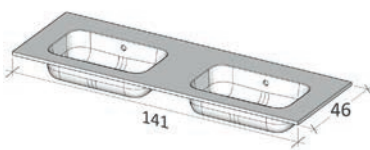

Livit Velvet Slim - 140 cm

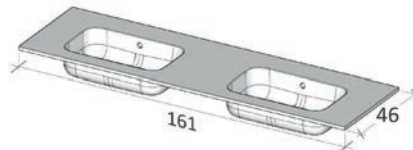

Livit Velvet Slim - 160 cm

LIVIT VELVET TOP

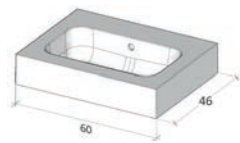

Livit Velvet Top - 60 cm

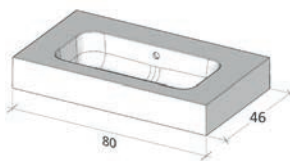

Livit Velvet Top - 80 cm

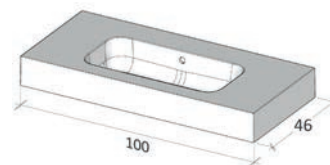

Livit Velvet Top - 100 cm

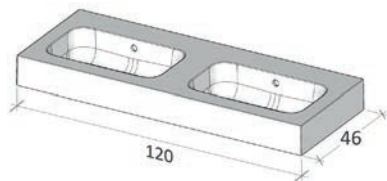

Livit Velvet Top - 120 cm

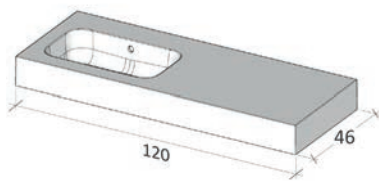

Livit Velvet Top - 120 cm

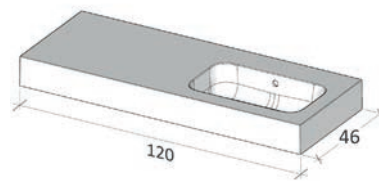

Livit Velvet Top - 120 cm

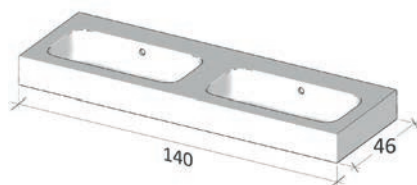

Livit Velvet Top - 140 cm

LIVIT STONE SLIM

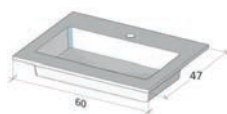

Livit Stone Slim - 60 cm

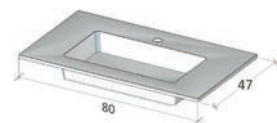

Livit Stone Slim - 80 cm

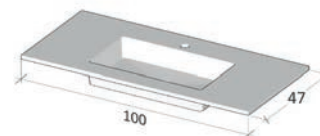

Livit Stone Slim - 100 cm

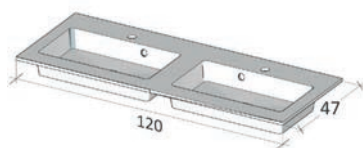

Livit Stone Slim - 100 cm

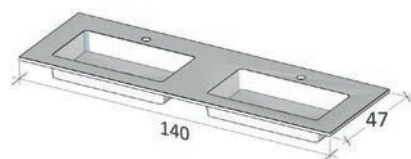

Livit Stone Slim - 100 cm

LIVIT STONE TOP

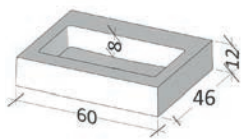

Livit Stone Top - 60 cm

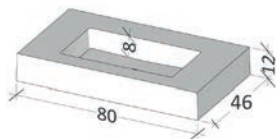

Livit Stone Top - 80 cm

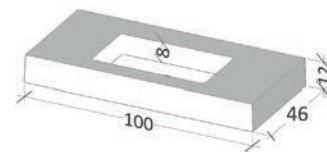

Livit Stone Top - 100 cm

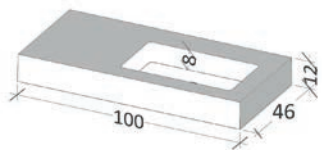

Livit Stone Top - 100 cm

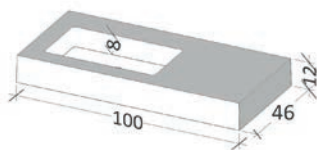

Livit Stone Top - 100 cm

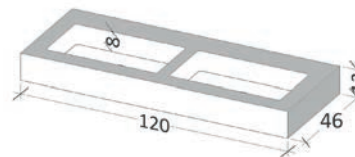

Livit Stone Top - 120 cm

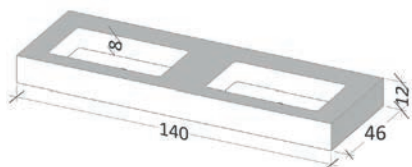

Livit Stone Top - 140 cm



SPODNÍ SKŘÍŇKY

bez omezení prostoru v zásuvce

možnosti barevného provedení

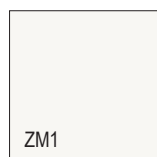

ZM1
Frosted

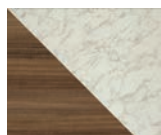

X00
bílý mramor +
Mahagoni

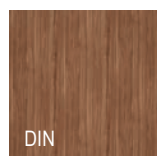

DIN
Copper

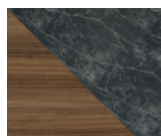

X01
černý mramor +
Mahagoni

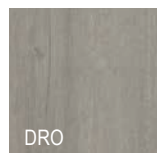

DRO
Smoke



X02
Pitch Black
bílý mramor



DRE
Café au Lait

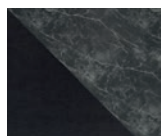

X03
Pitch Black
černý mramor

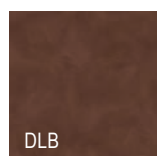

DLB
Corton



DLL
Larson

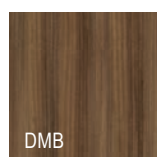

DMB
Mahagoni



DW6
Černá

1 zásuvka bez omezení prostoru

		Bezuchytkové černá	Výřez na sifon v zásuvce	Cena
40 cm		F011049CODE		12 191,-/14 751,-
60 cm		F011021CODE		12 898,-/15 607,-
70 cm		F011022CODE		12 954,-/15 674,-
80 cm		F011023CODE		13 628,-/16 490,-
100 cm		F011024CODE		14 505,-/17 551,-
120 cm		F011025CODE		15 965,-/19 318,-

2 zásuvky bez omezení prostoru

		Bezuchytkové černá	Výřez na sifon v zásuvce	Cena
40 cm		F011051CODE		17 436,-/21 098,-
60 cm		F011031CODE		18 516,-/22 404,-
70 cm		F011047CODE		19 156,-/23 179,-
80 cm		F011032CODE		19 864,-/24 035,-
100 cm		F011033CODE		21 223,-/25 680,-
120 cm		F011034CODE		23 324,-/28 222,-

SPODNÍ SKŘÍŇKY

s omezeným prostorem v zásuvce

možnosti barevného provedení

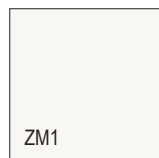

ZM1
Frosted



X00
bílý mramor +
Mahagoni

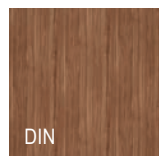

DIN
Copper



X01
černý mramor +
Mahagoni

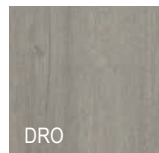

DRO
Smoke



X02
Pitch Black
bílý mramor

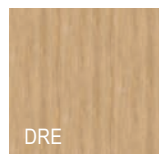

DRE
Café au Lait

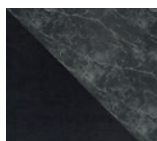

X03
Pitch Black
černý mramor

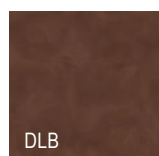

DLB
Corton



DLL
Larson

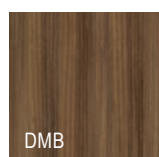

DMB
Mahagoni

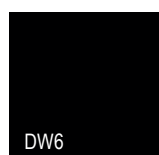

DW6
Černá

1 zásuvka s omezeným prostorem

		Bezuchytkové černá	Výřez na sifon v zásuvce	Cena
60 cm		F011001CODE		13 269,-/16 055,-
70 cm		F011002CODE		13 628,-/16 490,-
80 cm		F011003CODE		13 977,-/16 912,-
100 cm		F011004CODE		14 842,-/17 959,-
120 cm		F011005CODE		16 864,-/20 405,-

2 zásuvky s omezeným prostorem

		Bezuchytkové černá	Výřez na sifon v zásuvce	Cena
60 cm		F011011CODE		18 863,-/22 824,-
70 cm		F011012CODE		19 448,-/23 532,-
80 cm		F011013CODE		20 211,-/24 455,-
100 cm		F011014CODE		21 571,-/26 101,-
120 cm		F011015CODE		25 088,-/30 356,-

SPODNÍ SKŘÍŇKY s omezením prostoru v zásuvce vlevo nebo vpravo

možnosti barevného provedení

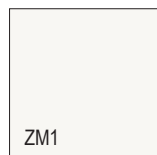

ZM1
Frosted



X00
bílý mramor +
Mahagoni

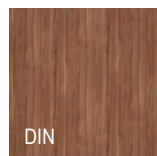

DIN
Copper



X01
černý mramor +
Mahagoni

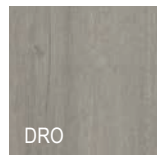

DRO
Smoke



X02
Pitch Black
bílý mramor



DRE
Café au Lait

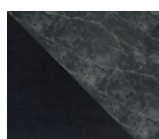

X03
Pitch Black
černý mramor

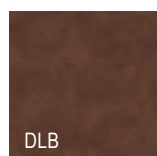

DLB
Corton



DLL
Larson

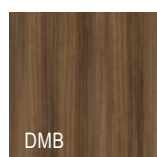





DMB
Mahagoni



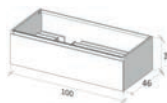



DW6
Černá



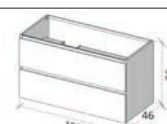

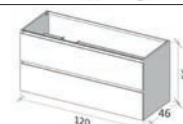
1 zásuvka s omezením prostoru vlevo

		Výřez na sifon v zásuvce	Cena
100 cm			F011053CODE 14 830,-/17 944,-
120 cm			F011039CODE 15 932,-/19 278,-



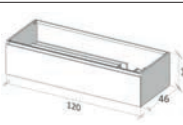

2 zásuvky s omezením prostoru vlevo

		Výřez na sifon v zásuvce	Cena
100 cm			F011057CODE 21 560,-/26 088,-
120 cm			F011043CODE 23 234,-/28 113,-

1 zásuvka s omezením prostoru vpravo

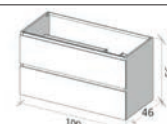

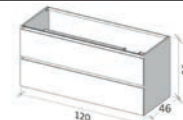



		Výřez na sifon v zásuvce	Cena
100 cm			F011054CODE 14 830,-/17 944,-
120 cm			F011040CODE 15 932,-/19 278,-

2 zásuvky s omezením prostoru vpravo

		Výřez na sifon v zásuvce	Cena
100 cm			F011058CODE 21 560,-/26 088,-
120 cm			F011044CODE 23 234,-/28 113,-

RÁM BUDDY



RÁM BUDDY

	40 cm	60 cm	70 cm	80 cm	100 cm	120 cm
						
	F010006304	F010002304	F010007304	F010003304	F010004304	F010005304
Cena	7 921,-/9 584,-	8 493,-/10 277,-	8 595,-/10 400,-	8 752,-/10 590,-	8 988,-/10 875,-	9 561,-/11 569,-

BUDDY SKŘÍŇKA



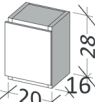





BUDDY skříňka

BUDDY skříňka







	S	L
		
Obj. č.	F011062CODE	F011063CODE
Cena	7 786,-/9 421,-	8 876,-/10 740,-

KRYCÍ DESKA

Horní krycí deska

	20 cm	40 cm	60 cm	70 cm	80 cm	100 cm	120 cm	140 cm	160 cm
									
Obj. č.	F011153CODE	F011130CODE	F011131CODE	F011144CODE	F011132CODE	F011133CODE	F011134CODE	F011135CODE	F011136CODE
Cena	1 360,-/1 646,-	1 551,-/1 877,-	1 831,-/2 216,-	1 989,-/2 407,-	2 090,-/2 529,-	2 359,-/2 854,-	2 629,-/3 181,-	2 797,-/3 384,-	2 966,-/3 589,-

Dolní krycí deska

	36,2 cm	56,2 cm	66,2 cm	76,2 cm	96,2 cm	116,2 cm
						
Obj. č.	F011138CODE	F011139CODE	F011145CODE	F011140CODE	F011141CODE	F011142CODE
Cena	1 315,-/1 591,-	1 528,-/1 849,-	1 652,-/1 999,-	1 752,-/2 120,-	1 967,-/2 380,-	2 213,-/2 678,-







PŘÍSLUŠENSTVÍ

V příslušenství k nábytku Livit najdete spoustu výrobků, které můžete kombinovat s nábytkovými prvky této série. Vybírejte si z několika barevných variant CLIC-CLAC sifonů, z mnoha možností zrcadel. Koupelnový nábytek doplňte světly a bočními skříňkami, BUDDY RÁMY a krycími deskami.





SIFONY CLIC-CLAC S KRYTY





CLIC-CLAC

	CLIC-CLAC VELVET přepad černý	CLIC-CLAC VELVET přepad bílý	CLIC-CLAC VELVET přepad SOLID bílý	CLIC-CLAC GLAZE TOP přepad černý	CLIC-CLAC GLAZE TOP přepad keramický bílý
					
	Pro umyvadel VELVET SLIM a VELVET TOP			Pro umyvadla GLAZE TOP	
Obj. č.	205481	205486	205489	205490	205491
Cena	1 337,-/1 618,-	1 337,-/1 618,-	2 528,-/3 059,-	1 337,-/1 618,-	1 730,-/2 093,-

CLIC-CLAC

	Bílá	Černá	Chrom
			
Obj. č.	205206	205204	205205
Cena	629,-/761,-	629,-/761,-	528,-/639,-

Neuzavíratelný sifon

	Neuzavíratelný sifon bílý	Neuzavíratelný sifon černý	Neuzavíratelný sifon chrom	Neuzavíratelný sifon černý
				
	Pro umyvadla STONE SLIM a STONE TOP		Pro všechna umyvadla	
Obj. č.	205493	205492	205483	205484
Cena	1 674,-/2 026,-	1 674,-/2 026,-	1 169,-/1 414,-	1 281,-/1 550,-





SIFONY

Sifony



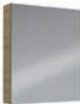

	Bílá	Černá	Chrom
			
	Pro všechna umyvadla		
Obj. č.	201183	201182	201181
Cena	1 315,-/1 591,-	1 315,-/1 591,-	1 315,-/1 591,-

ZRCADLOVÁ SKŘÍŇKA TYP 13

Zrcadlová skříňka typ 13

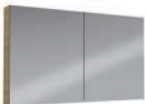
	60 cm 1 dvířka	60 cm 2 dvířka	80 cm 2 dvířka	80 cm 2 dvířka	100 cm 2 dvířka
					
Obj. č.	F016013CODE	F016014CODE	F016016CODE	F016017CODE	F016019CODE
Cena	13 426,-/16 245,-	16 078,-/19 454,-	17 144,-/20 744,-	17 055,-/20 637,-	18 751,-/22 689,-

Zrcadlová skříňka typ 13

	120 cm 2 dvířka	140 cm (2 x 70 cm)	160 cm (2 x 80 cm)	180 cm (2 x 90 cm)
				
Obj. č.	F016020CODE	2x F016015CODE	2x F016017CODE	2x F016018CODE
Cena	19 965,-/24 158,-	16 392,-/19 834,-	17 055,-/20 637,-	18 223,-/22 050,-

Všechny koupelnové nábytky z řady Livit jsou nabízeny v těchto barevných odstínech:

							
ZM1	DIN	DRO	DRE	DLB	DLL	DMB	DW6
Frosted	Copper	Smoke	Café au Lait	Corton	Larson	Mahagoni	Černá

BOČNÍ SKŘÍŇKY

Boční skříňky

	Vysoká boční skříňka 1 dveře L/P provedení	Polovysoká boční skříňka 1 dveře, L/P provedení
	F011125CODE	F011126CODE
Cena	15 999,-/19 359,-	12 808,-/15 498,-



Všechny koupelňové nábytky z řady Livit jsou nabízeny v těchto barevných odstínech:

ZM1 Frosted	DIN Copper	DRO Smoke	DRE Café au Lait	DLB Corton	DLL Larson	DMB Mahagoni	DW6 Černá

X00 bílý mramor + Mahagoni	X01 černý mramor + Mahagoni	X02 Pitch Black bílý mramor	X03 Pitch Black černý mramor

BUDDY RÁMY A KRYCÍ DESKY

RÁM BUDDY

	Buddy 35x35cm	Buddy 70x35cm
	F010001304	F010010304
Cena	7 719,-/9 340,-	8 460,-/10 237,-

Krycí deska

	Horní krycí deska 35 x 35 x 1 cm	Horní krycí deska 70 x 35 x 1 cm	Dolní krycí deska 31,2 x 31,2 x 1,8 cm	Dolní krycí deska 62 x 31,2 x 1,8 cm
Obj. č.	F011129CODE	F011151CODE	F011137CODE	F011152CODE
Cena	1 405,-/1 700,-	1 865,-/2 257,-	1 180,-/1 428,-	1 539,-/1 862,-





FROMSCRATCH
design collection by Riho

KRÁSA JEDNODUCHOSTÍ

Čistá dokonalost a minimalistický design.

Solid surface dodá vaší koupelně příjemnou atmosféru. To také vysvětluje vysoký zájem o koupelnový nábytek v kombinaci s materiálem Solid Surface.

FromScratch vnese do vaší koupelny luxusní vzhled. V této kolekci si můžete vybrat umyvadlo Aviano, masivní krycí desky Avella nebo dekorativní krycí desky v dekoru dřeva.

Aviano má jedno nebo dvě hladce integrovaná umyvadla. Je krásné na pohled a snadno se udržuje.

Krycí desku ze Solid Surface nebo krycí desku v dekoru dřeva lze kombinovat se širokým výběrem umyvadel z řady Slate a Avella.

FromScratch je luxusní řada nábytku RIHO.

Matný bílý materiál dokonale ladí se všemi dekory v naší nabídce a se všemi možnostmi lakovaných povrchů. Používáme dvousložkový lak, který posouvá koupelnový nábytek na vyšší úroveň.

Vytvořte si koupelnu moderního vzhledu s výběrem z palety našich nových trendových barev.

Fromscratch barvy.....	str. 406
Objednávací metoda Fromscratch	str. 405
Základní sety Fromscratch s krycí deskou	str. 411
Základní sety Fromscratch s umyvadly	str. 411

OBJEDNACÍ METODA FROMSCRATCH

1. Vyberte si typ umyvadla

- Krycí desku v dekoru dřeva nebo z materiálu Solid Surface
- Umyvadlo z materiálu Solid Surface

2. Vyberte si z námi nabízených setů nábytku

Sety jsou seřazeny podle typu umyvadla.

Namísto CODE zadejte objednávací kód barvy

3. Určete si délku nábytku

- Můžete si vybrat z délek 80 cm, 120 cm, 140 cm, 160 cm a 180 cm.

Pro objednání setu je třeba jen jedno objednávací číslo.

Součástí setu je chromový CLIC-CLACK

BARVY FROMSCRATCH

Dřevěné dekory - CODE

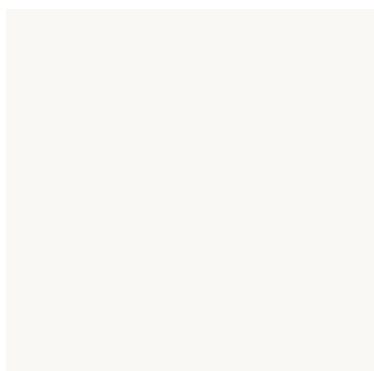
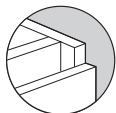

ZM1 - Frosted

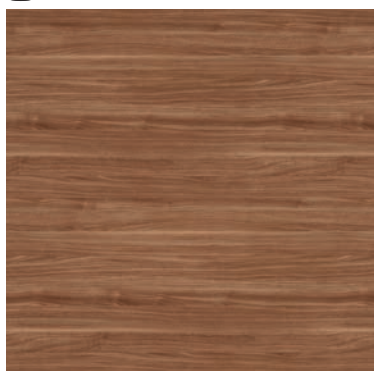

DIN - Copper



DRO - Smoke



DRE - Café au lait

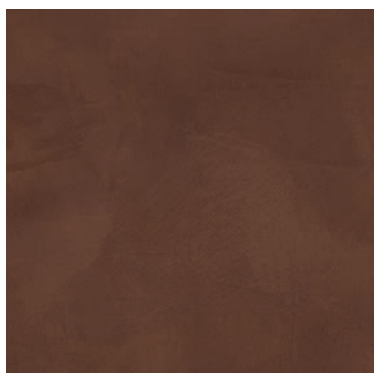

DLB - Corten

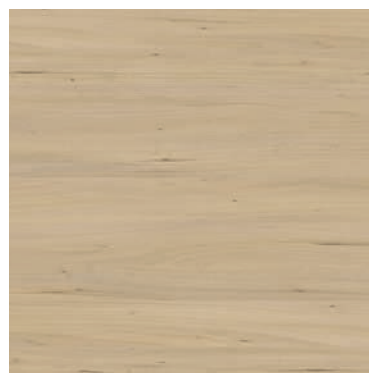

DLL - Larson



DMB - Mahogany

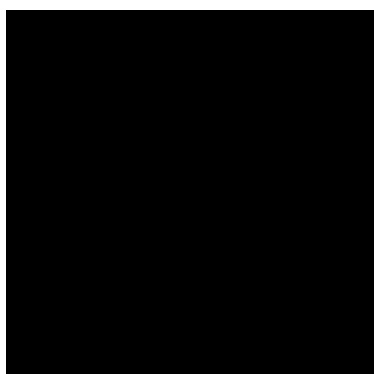

DW6 - Pitch Black

NOVÉ BARVY FROMSCRATCH

Nepochybně jste se s ní již mnohokrát setkali s koupelnami zařízených v jemných zemitých tónech. Je to obrovský trend současné doby. Přírodní odstíny odkazují na venkovní prostředí, a proto dodávají uklidňující vzhled i uvnitř vašeho domova. Tyto barvy jsou tedy ideální i pro stylovou koupelnu kde si chcete odpočinout a relaxovat. Proto představujeme dvě nové trendové barvy v naší nábytkové řadě FROMSCRATHC: Moss Green a Sand Taupe.

BARVY FROMSCRATCH

Satén lak - SILK

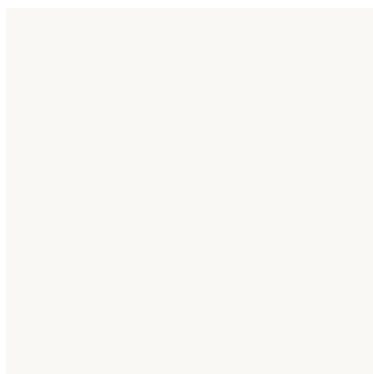
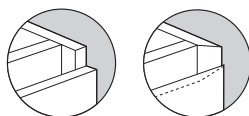

Z01 Bílá



Z06 Černá



Z09 Tmavě šedá

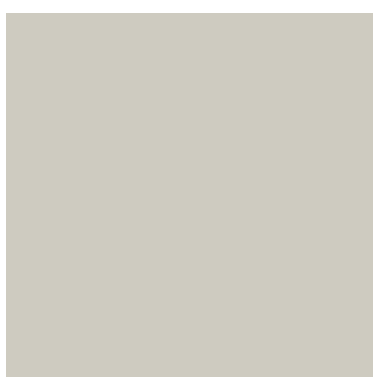

Z16 Off White



Z19 Mustard Gold



Z20 Terracotta



Z21 Midnight

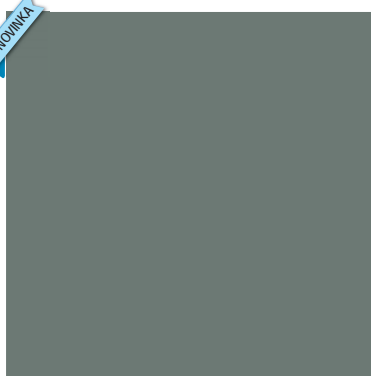

Z22 - Moss Green



Z23 - Sand Taupe

Vysoký lesk lak - GLOSS

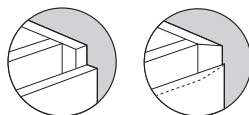

R01 Bílá



R06 Černá



R09 Tmavě šedá

KRYCÍ DESKA SOLID SURFACE

- matná bílá barva výška krycí desky 1,2 cm bez otvorů na baterie možno kombinovat se všemi barevnými dekory dřeva i lakovanými povrchy

KRYCÍ DESKA DEKOR DŘEVO

- výška krycí desky dekor dřevo 1,8 cm



UMYVADLA ZE SOLID SURFACE AVIANO

- matná bílá barva výška umyvadla 2 cm bez otvoru na baterie není omezen prostor v zásuvce součástí dodávky je sifon 01



Krycí deska dekor dřevo / Krycí deska SOLID SURFACE



Krycí deska zobrazená ve variantě Solid Surface je k dispozici také v dřevěném dekoru nebo laku (tloušťka 1,8 cm)

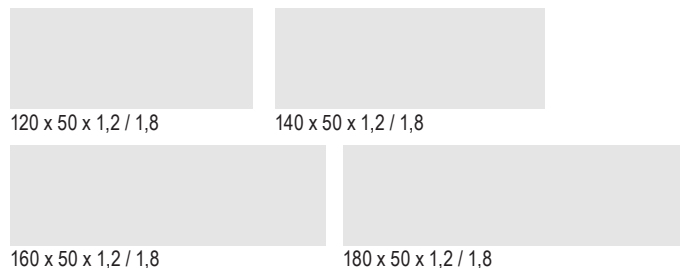

120 x 50 x 1,2 / 1,8

140 x 50 x 1,2 / 1,8

160 x 50 x 1,2 / 1,8

180 x 50 x 1,2 / 1,8

Umyvadla ze SOLID SURFACE Aviano



120 x 50 x 2



140 x 50 x 2



140 x 50 x 2



160 x 50 x 2



180 x 50 x 2

Sety nábytku Fromscratch

Varianty A (krycí desky ze Solid Surface nebo v dekoru dřeva)

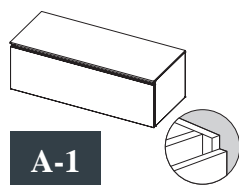

A-1

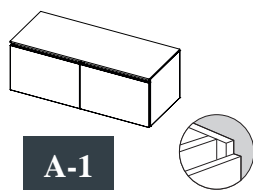

A-1

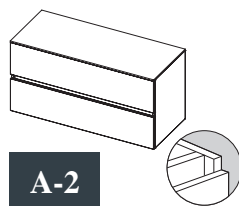

A-2

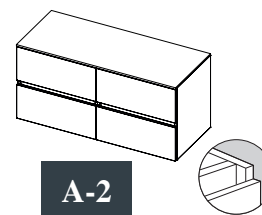

A-2

Varianta B (krycí deska ze Solid Surface nebo v dekoru dřeva)

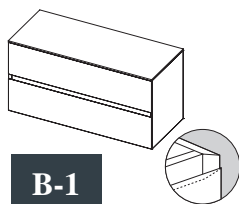

B-1

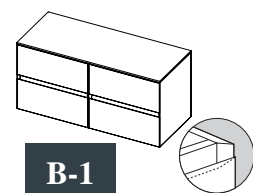

B-1

Sety B jsou k dispozici pouze v lakovaných odstínech - SILK, GLOSS

Varianta A (Umyvadlo ze Solid Surface)

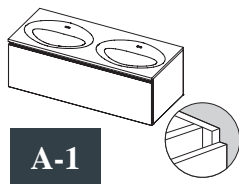

A-1

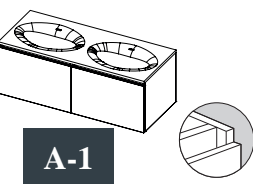

A-1

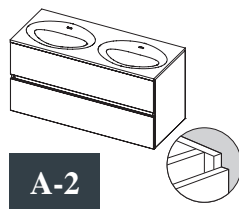

A-2

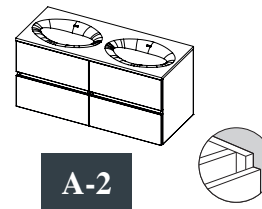

A-2

Varianta B (Umyvadlo ze Solid Surface)

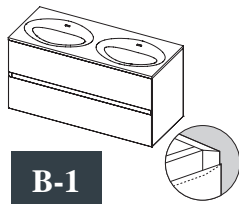

B-1

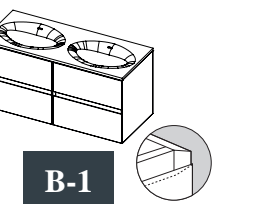



B-1

Sety B jsou k dispozici pouze v lakovaných odstínech - SILK, GLOSS

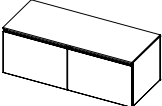
SETY S KRYCÍMI LAKOVANÝMI DESKAMI





A-1 

Rozměr nábytku (d x h x v)	Rozměr krycí desky (d x š x v)	Počet otvorů na baterie	Umístění vyřezu v zásuvce na sifon	Obj. č.	Cena dekor dřeva	Obj. č.	Cena dekor Satén	Obj. č.	Cena vysoký lesk
80 x 50 x 39	80 x 50 x 1,8	0		F013001CODE	18 033,-/21 820,-	F013001SILK	28 852,-/34 911,-	F013001GLOSS	33 885,-/41 001,-
120 x 50 x 39	120 x 50 x 1,8	0		F013004CODE	21 818,-/26 400,-	F013004SILK	35 188,-/42 577,-	F013004GLOSS	41 929,-/50 734,-



A-1 

Rozměr nábytku (d x h x v)	Rozměr krycí desky (d x š x v)	Počet otvorů na baterie	Umístění vyřezu v zásuvce na sifon	Obj. č.	Cena dekor dřeva	Obj. č.	Cena dekor Satén	Obj. č.	Cena vysoký lesk
160 x 50 x 39	160 x 50 x 1,8	0		F013014CODE	35 930,-/43 475,-	F013014SILK	57 545,-/69 629,-	F013014GLOSS	67 623,-/81 824,-

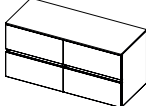

A-2 

Rozměr nábytku (d x h x v)	Rozměr krycí desky (d x š x v)	Počet otvorů na baterie	Umístění vyřezu v zásuvce na sifon	Obj. č.	Cena dekor dřeva	Obj. č.	Cena dekor Satén	Obj. č.	Cena vysoký lesk
80 x 50 x 54	80 x 50 x 1,8	0		F013002CODE	25 515,-/30 873,-	F013002SILK	38 109,-/46 112,-	F013002GLOSS	44 266,-/53 562,-
120 x 50 x 54	120 x 50 x 1,8	0		F013006CODE	30 054,-/36 365,-	F013006SILK	45 973,-/55 627,-	F013006GLOSS	54 062,-/65 415,-
120 x 50 x 59	120 x 50 x 1,8	0		F013008CODE	29 975,-/36 270,-	F013008SILK	45 480,-/55 031,-	F013008GLOSS	53 569,-/64 818,-
140 x 50 x 59	140 x 50 x 1,8	0		F013012CODE	31 716,-/38 376,-	F013012SILK	48 782,-/59 026,-	F013012GLOSS	57 815,-/69 956,-
160 x 50 x 59	160 x 50 x 1,8	0		F013018CODE	40 873,-/49 456,-	F013018SILK	59 490,-/71 983,-	F013018GLOSS	69 454,-/84 039,-

A-2 

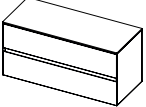
Rozměr nábytku (d x h x v)	Rozměr krycí desky (d x š x v)	Počet otvorů na baterie	Umístění vyřezu v zásuvce na sifon	Obj. č.	Cena dekor dřeva	Obj. č.	Cena dekor Satén	Obj. č.	Cena vysoký lesk
160 x 50 x 54	160 x 50 x 1,8	0		F013016CODE	50 883,-/61 568,-	F013016SILK	76 073,-/92 048,-	F013016GLOSS	88 364,-/106 920,-
180 x 50 x 54	180 x 50 x 1,8	0		F013022CODE	53 232,-/64 411,-	F013022SILK	79 982,-/96 778,-	F013022GLOSS	93 239,-/112 819,-
180 x 50 x 59	180 x 50 x 1,8	0		F013024CODE	51 141,-/61 881,-	F013024SILK	77 454,-/93 719,-	F013024GLOSS	90 846,-/109 924,-

B-1 

Rozměr nábytku (d x h x v)	Rozměr krycí desky (d x š x v)	Počet otvorů na baterie	Umístění vyřezu v zásuvce na sifon	Obj. č.	Cena dekor dřeva	Obj. č.	Cena dekor Satén	Obj. č.	Cena vysoký lesk
120 x 50 x 59	80 x 50 x 1,8	0		F013026SILK	46 704,-/56 512,-	F013026SILK	46 704,-/56 512,-	F013026GLOSS	55 276,-/66 884,-
140 x 50 x 59	140 x 50 x 1,8	0		F013028SILK	50 052,-/60 563,-	F013028SILK	50 052,-/60 563,-	F013028GLOSS	59 636,-/72 160,-
160 x 50 x 59	160 x 50 x 1,8	0		F013030SILK	60 827,-/73 601,-	F013030SILK	60 827,-/73 601,-	F013030GLOSS	71 409,-/86 405,-

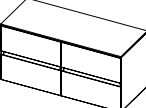
B-1 

Rozměr nábytku (d x h x v)	Rozměr krycí desky (d x š x v)	Počet otvorů na baterie	Umístění vyřezu v zásuvce na sifon	Obj. č.	Cena dekor dřeva	Obj. č.	Cena dekor Satén	Obj. č.	Cena vysoký lesk
180 x 50 x 59	180 x 50 x 1,8	0		F013032SILK	75 949,-/91 898,-	F013032SILK	75 949,-/91 898,-	F013032GLOSS	89 420,-/108 198,-

KRYCÍ DESKA SOLID SURFACE





A-1





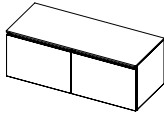

Rozměr nábytku (d x h x v)	Rozměr krycí desky (d x š x v)	Počet otvorů na baterie	Umístění vyřezu v zásuvce na sifon	Obj. č.	Cena dekor dřeva	Obj. č.	Cena dekor Satén	Obj. č.	Cena vysoký lesk
120 x 50 x 39	120 x 50 x 1,8	0		F013003CODE	27 750,-/33 578,-	F013003SILK	36 806,-/44 535,-	F013003GLOSS	40 895,-/49 483,-

A-1

Rozměr nábytku (d x h x v)	Rozměr krycí desky (d x š x v)	Počet otvorů na baterie	Umístění vyřezu v zásuvce na sifon	Obj. č.	Cena dekor dřeva	Obj. č.	Cena dekor Satén	Obj. č.	Cena vysoký lesk
160 x 50 x 39	160 x 50 x 1,8	0		F013013CODE	42 648,-/51 604,-	F013013SILK	58 546,-/70 841,-	F013013GLOSS	65 084,-/78 752,-
180 x 50 x 39	180 x 50 x 1,8	0		F013019CODE	47 277,-/57 205,-	F013019SILK	66 432,-/80 383,-	F013019GLOSS	73 387,-/88 798,-





A-2





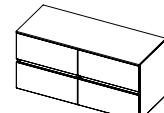





Rozměr nábytku (d x h x v)	Rozměr krycí desky (d x š x v)	Počet otvorů na baterie	Umístění vyřezu v zásuvce na sifon	Obj. č.	Cena dekor dřeva	Obj. č.	Cena dekor Satén	Obj. č.	Cena vysoký lesk
120 x 50 x 54	120 x 50 x 1,8	0		F013005CODE	35 986,-/43 543,-	F013005SILK	47 591,-/57 585,-	F013005GLOSS	53 029,-/64 165,-
120 x 50 x 59	120 x 50 x 1,8	0		F013007CODE	35 885,-/43 421,-	F013007SILK	47 086,-/56 974,-	F013007GLOSS	52 535,-/63 567,-
140 x 50 x 59	140 x 50 x 1,8	0		F013011CODE	38 031,-/46 018,-	F013011SILK	50 097,-/60 617,-	F013011GLOSS	56 018,-/67 782,-
160 x 50 x 59	160 x 50 x 1,8	0		F013017CODE	47 591,-/57 585,-	F013017SILK	60 489,-/73 192,-	F013017GLOSS	66 927,-/80 982,-



A-2

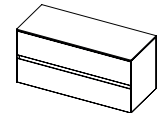

Rozměr nábytku (d x h x v)	Rozměr krycí desky (d x š x v)	Počet otvorů na baterie	Umístění vyřezu v zásuvce na sifon	Obj. č.	Cena dekor dřeva	Obj. č.	Cena dekor Satén	Obj. č.	Cena vysoký lesk
160 x 50 x 54	160 x 50 x 1,8	0		F013015CODE	57 602,-/69 698,-	F013015SILK	77 061,-/93 244,-	F013015GLOSS	85 824,-/103 847,-
180 x 50 x 54	180 x 50 x 1,8	0		F013021CODE	63 377,-/76 686,-	F013021SILK	83 667,-/101 237,-	F013021GLOSS	92 959,-/112 480,-
180 x 50 x 59	180 x 50 x 1,8	0		F013023CODE	61 276,-/74 144,-	F013023SILK	81 162,-/98 206,-	F013023GLOSS	90 566,-/109 585,-

B-1





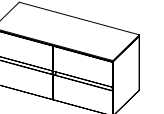

Rozměr nábytku (d x h x v)	Rozměr krycí desky (d x š x v)	Počet otvorů na baterie	Umístění vyřezu v zásuvce na sifon	Obj. č.	Cena dekor Satén	Obj. č.	Cena vysoký lesk
120 x 50 x 59	80 x 50 x 1,8	0		F013025SILK	48 311,-/58 456,-	F013025GLOSS	54 243,-/65 634,-
140 x 50 x 59	140 x 50 x 1,8	0		F013027SILK	51 366,-/62 153,-	F013027GLOSS	57 849,-/69 997,-
160 x 50 x 59	160 x 50 x 1,8	0		F013029SILK	61 826,-/74 809,-	F013029GLOSS	68 859,-/83 319,-









B-1



































Rozměr nábytku (d x h x v)	Rozměr krycí desky (d x š x v)	Počet otvorů na baterie	Umístění vyřezu v zásuvce na sifon	Obj. č.	Cena dekor Satén	Obj. č.	Cena vysoký lesk
180 x 50 x 59	180 x 50 x 1,8	0		F013031SILK	83 454,-/100 979,-	F013031GLOSS	93 610,-/113 268,-

AVIANO



Rozměr nábytku (d x h x v)	Rozměr umyvadla (d x h x v)	Počet otvorů na baterie	Umístění umyvadla	Barva umyvadla	Umístění vyřezu v zásuvce na sifon	Obj. č.	Cena dekor dřeva						
								Obj. č.	Cena dekor Satén	Obj. č.	Cena vysoký lesk		
120 x 50 x 39	120 x 50 x 2	0				F013033CODE	34 649,-/41 925,-	F013033SILK	43 716,-/52 896,-	F013033GLOSS	47 794,-/57 831,-		

Rozměr nábytku (d x h x v)	Rozměr umyvadla (d x h x v)	Počet otvorů na baterie	Umístění umyvadla	Barva umyvadla	Umístění vyřezu v zásuvce na sifon	Obj. č.	Cena dekor dřeva						
								Obj. č.	Cena dekor Satén	Obj. č.	Cena vysoký lesk		
160 x 50 x 50	160 x 50 x 2	0				F013040CODE	49 647,-/60 073,-	F013040SILK	65 545,-/79 309,-	F013040GLOSS	72 084,-/87 222,-		
180 x 50 x 50	180 x 50 x 2	0				F013043CODE	51 861,-/62 752,-	F013043SILK	71 005,-/85 916,-	F013043GLOSS	77 959,-/94 330,-		

Rozměr nábytku (d x h x v)	Rozměr umyvadla (d x h x v)	Počet otvorů na baterie	Umístění umyvadla	Barva umyvadla	Umístění vyřezu v zásuvce na sifon	Obj. č.	Cena dekor dřeva						
								Obj. č.	Cena dekor Satén	Obj. č.	Cena vysoký lesk		
120 x 50 x 54	120 x 50 x 2	0				F013034CODE	44 063,-/53 316,-	F013034SILK	55 670,-/67 361,-	F013034GLOSS	61 107,-/73 939,-		
120 x 50 x 59	120 x 50 x 2	0				F013035CODE	43 962,-/53 194,-	F013035SILK	55 175,-/66 762,-	F013035GLOSS	60 613,-/73 342,-		
140 x 50 x 59	140 x 50 x 2	0				F013038CODE	43 726,-/52 908,-	F013038SILK	55 782,-/67 496,-	F013038GLOSS	61 714,-/74 674,-		
140 x 50 x 59	140 x 50 x 2	0				F013039CODE	43 726,-/52 908,-	F013039SILK	55 782,-/67 496,-	F013039GLOSS	61 714,-/74 674,-		
160 x 50 x 59	160 x 50 x 2	0				F013042CODE	55 771,-/67 483,-	F013042SILK	68 668,-/83 088,-	F013042GLOSS	75 095,-/90 865,-		

Rozměr nábytku (d x h x v)	Rozměr umyvadla (d x h x v)	Počet otvorů na baterie	Umístění umyvadla	Barva umyvadla	Umístění vyřezu v zásuvce na sifon	Obj. č.	Cena dekor dřeva						
								Obj. č.	Cena dekor Satén	Obj. č.	Cena vysoký lesk		
160 x 50 x 54	160 x 50 x 2	0				F013041CODE	66 320,-/80 247,-	F013041SILK	85 768,-/103 779,-	F013041GLOSS	94 532,-/114 384,-		
180 x 50 x 54	180 x 50 x 2	0				F013044CODE	69 669,-/84 299,-	F013044SILK	89 970,-/108 864,-	F013044GLOSS	99 250,-/120 093,-		
180 x 50 x 59	180 x 50 x 2	0				F013045CODE	67 556,-/81 743,-	F013045SILK	87 442,-/105 805,-	F013045GLOSS	96 857,-/117 197,-		

Rozměr nábytku (d x h x v)	Rozměr umyvadla (d x h x v)	Počet otvorů na baterie	Umístění umyvadla	Barva umyvadla	Umístění vyřezu v zásuvce na sifon	Obj. č.	Cena dekor dřeva				
								Obj. č.	Cena dekor Satén	Obj. č.	Cena vysoký lesk
120 x 50 x 59	120 x 50 x 2	0				F013046SILK	56 400,-/68 244,-	F013046GLOSS	62 321,-/75 408,-		
140 x 50 x 59	140 x 50 x 2	0				F013047SILK	57 052,-/69 033,-	F013047GLOSS	63 545,-/76 889,-		
140 x 50 x 59	140 x 50 x 2	0				F013048SILK	57 052,-/69 033,-	F013048GLOSS	63 545,-/76 889,-		
160 x 50 x 59	160 x 50 x 2	0				F013049SILK	70 006,-/84 707,-	F013049GLOSS	77 050,-/93 231,-		

Rozměr nábytku (d x h x v)	Rozměr umyvadla (d x h x v)	Počet otvorů na baterie	Umístění umyvadla	Barva umyvadla	Umístění vyřezu v zásuvce na sifon	Obj. č.	Cena dekor dřeva				
								Obj. č.	Cena dekor Satén	Obj. č.	Cena vysoký lesk
180 x 50 x 59	180 x 50 x 2	0				F013050SILK	89 746,-/108 593,-	F013050GLOSS	99 901,-/120 880,-		

PŘÍSLUŠENSTVÍ

	Obj. č.	Popis	Rozměr	Cena
	F017001CODE	Boční skříňka Avella L/P Dekor dřeva 2 dvířka	40 x 40 x 171,5	16 752,-/20 270,-
	F017001SILK	Boční skříňka Avella L/P Satén 2 dvířka	40 x 40 x 171,5	33 469,-/40 497,-
	F017001GLOSS	Boční skříňka Avella L/P Vysoký lesk 2 dvířka	40 x 40 x 171,5	42 210,-/51 074,-
	F017002CODE	Boční skříňka Avella L/P Dekor dřeva 1 dvířka	40 x 40 x 171,5	16 269,-/19 685,-
	F017002SILK	Boční skříňka Avella L/P Satén 1 dvířka	40 x 40 x 171,5	32 345,-/39 137,-
	F017002GLOSS	Boční skříňka Avella L/P Vysoký lesk 1 dvířka	40 x 40 x 171,5	41 087,-/49 715,-
	F017003CODE	Boční skříňka Avella se zrcadlem L/P Dekor dřeva 1 dvířka	40 x 40 x 171,5	18 549,-/22 444,-
	F017003SILK	Boční skříňka Avella se zrcadlem L/P Satén 1 dvířka	40 x 40 x 171,5	34 637,-/41 911,-
	F017003GLOSS	Boční skříňka Avella se zrcadlem L/P Vysoký lesk 1 dvířka	40 x 40 x 171,5	43 379,-/52 489,-
	F017011CODE	Boční skříňka Cesio L/P Dekor dřeva 1 dvířka	35 x 32 x 171,5	14 775,-/17 878,-
	F017011SILK	Boční skříňka Cesio L/P Satén 1 dvířka	35 x 32 x 171,5	28 133,-/34 041,-
	F017011GLOSS	Boční skříňka Cesio L/P Vysoký lesk 1 dvířka	35 x 32 x 171,5	35 278,-/42 686,-
	F017023CODE	Boční skříňka Cesio L/P Dekor dřeva 2 dvířka	35 x 32 x 171,5	15 280,-/18 489,-

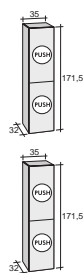

Obj. č.	Popis	Rozměr	Cena
F017023SILK	Boční skříňka Cesio L/P Satén 2 dvířka	35 x 32 x 171,5	29 177,-/35 304,-

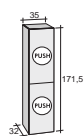

F017023GLOSS	Boční skříňka Cesio L/P Vysoký lesk 2 dvířka	35 x 32 x 171,5	36 334,-/43 964,-
--------------	---	-----------------	-------------------

KRYCÍ DESKA SOLID SURFACE

Obj. č.	Popis	Rozměr	Cena
W017001105	Krycí deska Solid Surface Avella	120 x 50 x 1,2	8 730,-/10 563,-
W017002105	Krycí deska Solid Surface Avella	140 x 50 x 1,2	9 314,-/11 270,-
W017003105	Krycí deska Solid Surface Avella	160 x 50 x 1,2	9 909,-/11 990,-
W017004105	Krycí deska Solid Surface Avella	180 x 50 x 1,2	13 516,-/16 354,-

UMYVADLA AVIANO

Obj. č.	Popis	Rozměr	Cena
W015001105	Umyvadlo Aviano bez otvorů na baterie	120 x 50 x 2	15 628,-/18 910,-
W015002105	Umyvadlo Aviano bez otvorů na baterie	140 x 50 x 2	14 145,-/17 115,-
W015003105	Umyvadlo Aviano bez otvorů na baterie	140 x 50 x 2	14 145,-/17 115,-
W015004105	Umyvadlo Aviano bez otvorů na baterie	160 x 50 x 2	16 909,-/20 460,-
W015005105	Umyvadlo Aviano bez otvorů na baterie	180 x 50 x 2	18 088,-/21 886,-



DALŠÍ UMYVADLA SOLID SURFACE NA STR. 21



RIHO

NÁBYTEK









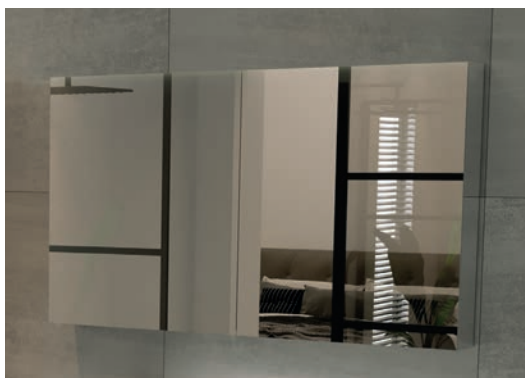



PŘÍSLUŠENSTVÍ

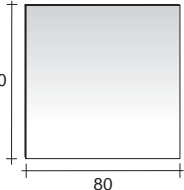

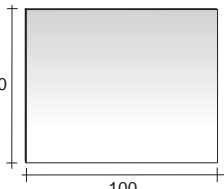
ZRCADLA TYP 12

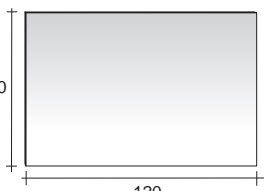
Zrcadla tohoto typu jsou vybavena montážními otvory pro osvětlení typu 07. Za zrcadlovým panelem je prostor pro elektrické připojení.

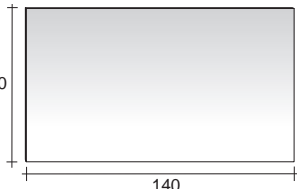

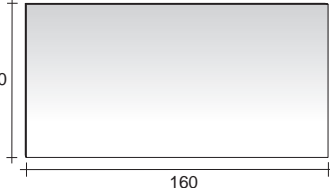













	Obj. č.	Cena	Rozměry
40 X 80 CM	205576 včetně 	3 528,-/4 269,-	
60 X 80 CM	205577 včetně 	3 764,-/4 554,-	
80 X 80 CM	205578 za příplatek 	4 258,-/5 152,-	
100 X 80 CM	205572 za příplatek 	4 506,-/5 452,-	
120 X 80 CM	205573 za příplatek 2x 	4 865,-/5 887,-	
140 X 80 CM	205574 za příplatek 2x 	5 483,-/6 634,-	
160 X 80 CM	205575 za příplatek 2x 	5 977,-/7 232,-	

veškeré osvětlení str. 428

ZRCADLA S OSVĚTLENÍM TYP 13

Zrcadlo s osvětlením T5 LED za vodorovným mléčným sklem, vybavené snímačem pohybu. Nepřímé světlo je atmosférické a rozptýlené. Zrcadlo se snadno čistí.













	Obj. č.	Cena	Rozměry
40 X 80 CM	205563	6 224,-/7 531,-	
	včetně  		
60 X 80 CM	205564	6 471,-/7 830,-	
	včetně  		
80 X 80 CM	205565	6 719,-/8 130,-	
	včetně  		
100 X 80 CM	205559	6 966,-/8 429,-	
	včetně  		
120 X 80 CM	205560	7 697,-/9 313,-	
	včetně  		
140 X 80 CM	205561	8 190,-/9 910,-	
	včetně  		
160 X 80 CM	205562	8 685,-/10 509,-	
	včetně  		



ZRCADLA

Zrcadlo s kovovým rámem o hloubce 2 cm. Zrcadla vybavena snímačem pohybu, není vybaveno osvětlením.

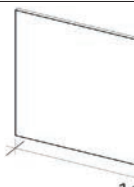

	Obj. č.	Cena	Rozměry
60 X 80 CM	■ 205539 Černá včetně 	5 864,-/7 095,-	
80 X 80 CM	■ 205541 Černá včetně 	6 932,-/8 388,-	
100 X 80 CM	■ 205531 Černá Bílá včetně 	7 539,-/9 122,-	
120 X 80 CM	■ 205533 Černá včetně 	8 247,-/9 979,-	
140 X 80 CM	■ 205535 Černá včetně 	8 909,-/10 780,-	
160 X 80 CM	■ 205537 Černá včetně 	9 617,-/11 637,-	

Zrcadlo je široké 40 cm, s kovovým rámem o hloubce 2 cm. Provedení bez snímače pohybu a osvětlení.

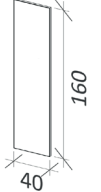
		Obj. č.	Cena	Rozměry
40 X 100 CM		205543 Černá	4 741,-/5 737,-	
40 X 160 CM		205544 Černá	5 089,-/6 158,-	



VYHŘÍVÁNÍ ZRCADEL

Vyhřívání zrcadel pro zrcadla umístěná v rámu.

	Obj. č.	Cena	Obj. č.	Cena
60 X 80 CM	205104	1 269,-/1 535,-	205102	2 044,-/2 473,-
80 X 80 CM	205105	1 697,-/2 053,-	205103	2 427,-/2 937,-

veškeré osvětlení str. 428

POLIČKA PRO ZRCADLA UMÍSTĚNÁ V RÁMU

V nabídce jsou v bílé a černé barvě, užitná plocha poličky je 10 cm.









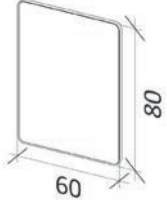

	Obj. č.	Cena	Rozměry
60 X 13 CM	205765 Černá	2 000,-/2 420,-	
80 X 13 CM	205767 Černá	2 101,-/2 542,-	
100 X 13 CM	205757 Černá	2 202,-/2 664,-	
120 X 13 CM	205759 Černá	2 292,-/2 773,-	
140 X 13 CM	205761 Černá	2 416,-/2 923,-	
160 X 13 CM	205763 Černá	2 517,-/3 046,-	

ZRCADLA SHIELD OBDÉLNÍKOVÁ SE ZABUDOVANÝM OSVĚTLENÍM

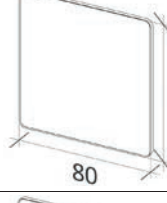
Zrcadla SHIELD obdélníková mají zaoblené rohy s nepřímým osvětlením po celém svém obvodu. Okraje zrcadla jsou barevné, dostupné v bílé a černé barvě.

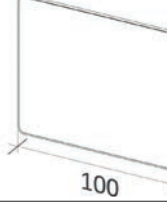

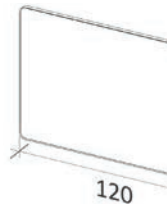
	Obj. č.	Cena	Rozměry
60 X 80 CM	■ 205552 Černá □ 205551 Bílá včetně  	11 999,-/14 519,-	
80 X 80 CM	■ 205554 Černá □ 205553 Bílá včetně  	14 134,-/17 102,-	
100 X 80 CM	■ 205548 Černá □ 205547 Bílá včetně  	15 504,-/18 760,-	
120 X 80 CM	■ 205550 Černá □ 205549 Bílá včetně  	17 178,-/20 785,-	

ZRCADLA SHIELD KRUHOVÁ

Zrcadla SHIELD kruhová jsou s nepřímým osvětlením po celém svém obvodu. Okraje zrcadla jsou barevné, dostupné v bílé a černé barvě.

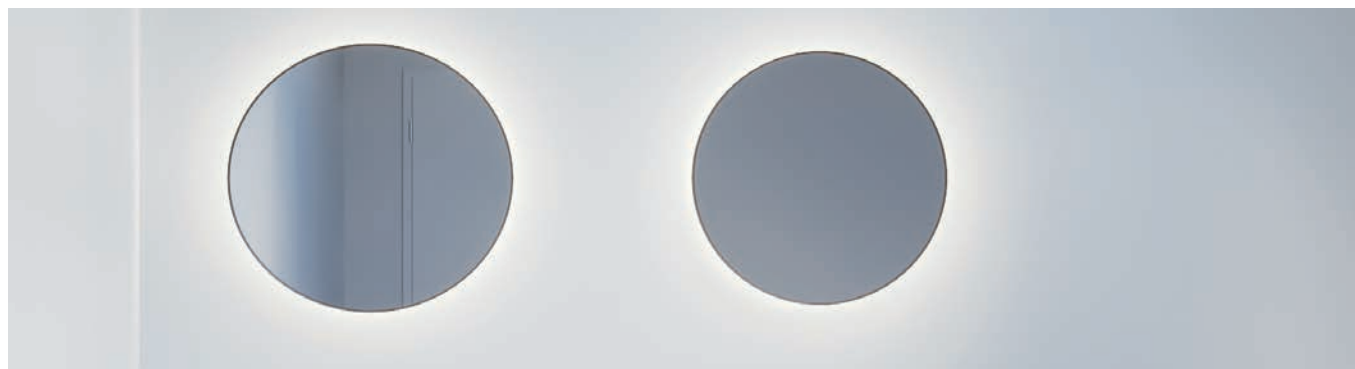

	Obj. č.	Cena	Rozměry
Ø 60 CM	■ 205555 Černá □ 205556Bílá	10 752,-/13 010,-	
	včetně 		
Ø 80 CM	■ 205557 Černá □ 205558 Bílá	13 909,-/16 830,-	
	včetně 		

NOVINKA: ZRCADLA PEBBLE

Zrcadla SHIELD kruhová jsou s nepřímým osvětlením po celém svém obvodu. Okraje zrcadla jsou barevné, dostupné v bílé a černé barvě.





	Obj. č.	Cena
NOVINKA 	216105	11 700,-/14 157,-
včetně 		

NOVINKA: ZRCADLA OVAL

Zrcadla SHIELD kruhová jsou s nepřímým osvětlením po celém svém obvodu. Okraje zrcadla jsou barevné, dostupné v v bílé a černé barvě.



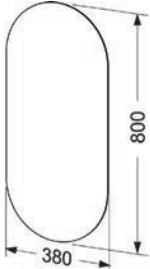

Obj. č.	Cena
216007	8 600,-/10 406,-
včetně	
 	
	

NOVINKA: ZRCADLA PEBBLE

Zrcadla SHIELD kruhová jsou s nepřímým osvětlením po celém svém obvodu. Okraje zrcadla jsou barevné, dostupné v v bílé a černé barvě.

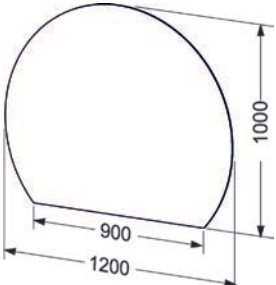

Obj. č.	Cena
216104	16 400,-/19 844,-
včetně	
 	
	

ZRCADLOVÁ SKŘÍŇKA TYP 13

Zrcadlová skříňka s oboustrannými zrcadlovými dvířky v bezúchytkovém provedení s panty pro odpružené zavírání. Tyto zrcadlové skřínky jsou vybaveny 2 policemi. Elektrická zásuvka a osvětlení jsou vám k dispozici samostatně.

Boční strany skříněk si můžete vybrat v barevných dekorech.

Dřevěné dekory - CODE







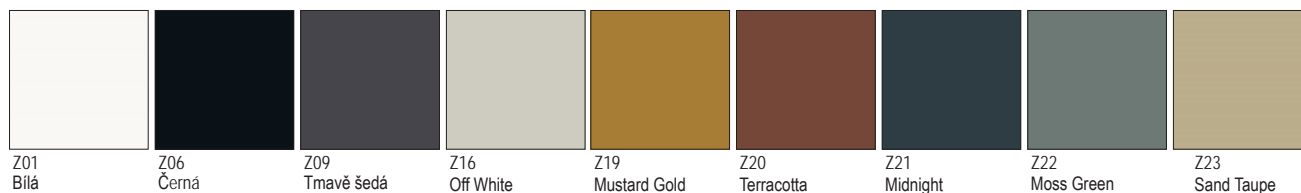



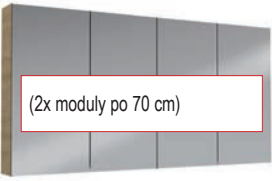

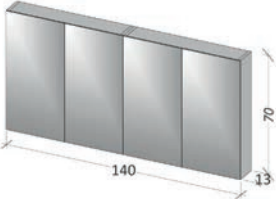
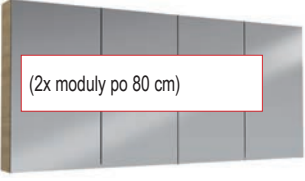

Vysoký lesk lak - GLOSS

Satén lak - SILK

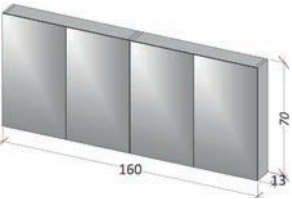
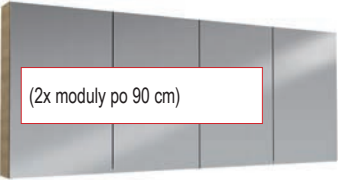

	Barva	Obj. č.	Cena	Rozměry
60 X 70 X 13 CM	Standard Satén Vysoký lesk	F016013CODE F016013SILK F016013GLOSS	13 426,-/16 245,- 16 066,-/19 440,- 16 864,-/20 405,-	
	za příplatek 	včetně 		
60 X 70 X 13 CM	Standard Satén Vysoký lesk	F016014CODE F016014SILK F016014GLOSS	16 078,-/19 454,- 18 707,-/22 635,- 19 515,-/23 613,-	
	za příplatek 	včetně 		
80 X 70 X 13 CM	Standard Satén Vysoký lesk	F016016CODE F016016SILK F016016GLOSS	17 144,-/20 744,- 19 785,-/23 940,- 20 594,-/24 919,-	
	za příplatek 	včetně 		
80 X 70 X 13 CM	Standard Satén Vysoký lesk	F016017CODE F016017SILK F016017GLOSS	17 055,-/20 637,- 19 706,-/23 844,- 20 504,-/24 810,-	
	za příplatek 	včetně 		
100 X 70 X 13 CM	Standard Satén Vysoký lesk	F016019CODE F016019SILK F016019GLOSS	18 751,-/22 689,- 21 447,-/25 951,- 22 257,-/26 931,-	
	za příplatek 	včetně 		
120 X 70 X 13 CM	Standard Satén Vysoký lesk	F016020CODE F016020SILK F016020GLOSS	19 965,-/24 158,- 22 673,-/27 434,- 23 481,-/28 412,-	
	za příplatek 	včetně 		

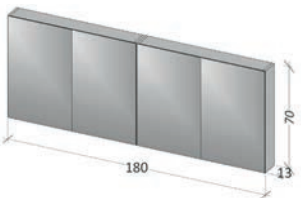
	Barva	Obj. č.	Cena	Rozměry
140 X 70 X 13 CM 	Standard Satén Vysoký lesk za příplatek  	2x F016015CODE 2x F016015SILK 2x F016015GLOSS včetně  	16 392,-/19 834,- 19 032,-/23 029,- 19 841,-/24 008,-	
160 X 70 X 13 CM 	Standard Satén Vysoký lesk za příplatek  	2x F016017CODE 2x F016017SILK 2x F016017GLOSS včetně  	17 055,-/20 637,- 19 706,-/23 844,- 20 504,-/24 810,-	
180 X 70 X 13 CM 	Standard Satén Vysoký lesk za příplatek  	2x F016018CODE 2x F016018SILK 2x F016018GLOSS včetně  	18 223,-/22 050,- 20 875,-/25 259,- 21 672,-/26 223,-	



VYBAVENÍ ZA PŘÍPLATEK: ELEKTRICKÁ ZÁSUVKA S VYPÍNAČEM TYP 13

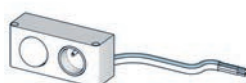









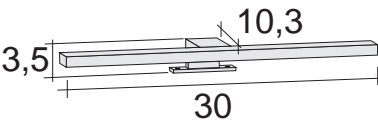



Obj. č.	Cena
202413 (IP20 RAND-CZ)	1 146,-/1 387,-
202412 (IP20 PEN)	1 146,-/1 387,-
202411 (IP20 CH)	1 146,-/1 387,-

VYBAVENÍ ZA PŘÍPLATEK: OSVĚTLENÍ

str.428

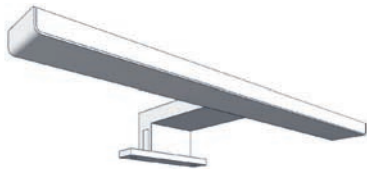
OSVĚTLENÍ

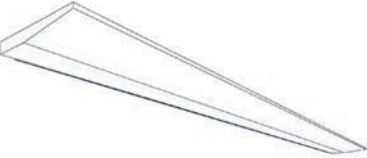
Popis	Obj. č.	Barva	Cena	
Osvětlení LED typ 07 s vestavěným trafem 4,8 Watt / 300 Lumen	204927	 Chrom	2 405,-/2 910,-	
	204926	 Černá	2 405,-/2 910,-	
	204928	 Bílá	2 405,-/2 910,-	
Osvětlení LED typ 08* s vestavěným trafem	204922 (40 cm)	 Černá	1 618,-/1 958,-	
	204923 (60 cm)	 Černá	2 596,-/3 141,-	
	204924 (80 cm)	 Černá	3 573,-/4 323,-	
	204920 (100 cm)	 Černá	3 730,-/4 513,-	
	204921 (120 cm)	 Černá	4 090,-/4 949,-	
Osvětlení LED typ 09 plastové s vestavěným trafem	204930	 Chrom	1 809,-/2 189,-	
	204929	 Černá	1 809,-/2 189,-	
Osvětlení LED typ 12** plexi křídélkové dodávané s trafem	204938 (60 cm)		3 899,-/4 718,-	
	204940 (80 cm)		4 135,-/5 003,-	
	204934 (100 cm)		932,-/5 968,-	
	204936 (120 cm)		887,-/7 123,-	

*u verze se 2 držáky musí být vyvrtány 2 otvory pro upevnění. Nelze použít pro zrcadla umístěná v rámech.

** Vhodné pouze pro zrcadla s rámy a zrcadlové skříňky

RIHO

 Toto svítidlo obsahuje zabudované světelné zdroje LED.

LED

~~A++~~

~~A+~~

~~A~~

~~B~~

~~C~~

~~D~~

~~E~~

} E

} D

Světelné zdroje v tomto svítidle nelze vyměnit.

874/2012 

RIHO

 Žárovky mohou být v tomto zařízení nahrazeny

LED

~~A++~~

~~A+~~

~~A~~

~~B~~

~~C~~

~~D~~

~~E~~

} E

} D

Toto osvětlení se prodává se žárovkou energetické třídy A

874/2012 



	Popis	Barva	Obj. č.	Cena
	pop-up waste CLIC-CLAC	<input type="checkbox"/> <input type="checkbox"/> <input type="checkbox"/>	Chrom 205205 Černá 205204 Bílá 205206	528,-/639,- 629,-/761,- 629,-/761,-
	pop-up waste CLIC-CLAC	<input type="checkbox"/>	Chrom 205207	315,-/381,-
	pop-up waste CLIC-CLAC	<input type="checkbox"/> <input type="checkbox"/>	keramický - Bílá 205203 keramický - Černá 205202	1 955,-/2 366,- 2 943,-/3 561,-
	Neuzavíratelný sifon	<input type="checkbox"/> <input type="checkbox"/>	Chrom 205483 Černá 205484	1 169,-/1 414,- 1 281,-/1 550,-
	Krytka sifonu	<input type="checkbox"/> <input type="checkbox"/>	Chrom 205812 Černá 205811	191,-/231,- 213,-/258,-
	Mistospořicí sifon s přepadem	<input type="checkbox"/>	Bílá 206756	832,-/1 007,-
	Mistospořicí sifon	<input type="checkbox"/>	Bílá 205190	2 022,-/2 447,-
	Mistospořicí sifon Ø 40 mm	<input type="checkbox"/>	Bílá 205186	607,-/734,-
	Designový sifon Ø32mm	<input type="checkbox"/>	Chrom 201181	1 315,-/1 591,-
	Mistospořicí sifon Ø 40 mm	<input type="checkbox"/>	Bílá 205185	719,-/870,-
	Designový sifon Ø 32 mm	<input type="checkbox"/> <input type="checkbox"/>	Černá 201182 Bílá 201183	1 315,-/1 591,- 1 315,-/1 591,-

LEGENDA



Možnost vanového panelu



Možnost vanové zástěny



Otevírání dveří vlevo



Počet otvorů pro baterii



Police + počet



Otevírání dveří vpravo



Sada na údržbu Solid výrobků



Dřevěné police + počet



Sifon nábytkový - úspora místa, Ø 40 mm



Push skříňka - tlačít



Krycí deska z litého mramoru



Elektrická zásuvka



Osvětlení



Zrcadlová skříňka: oboustranné zrcadlo



Krycí deska ze dřeva



Clac-clac umyvadlová výpust' solid surface



Clac-clac umyvadlová výpust'



Držák ručníku



2 držáky ručníku



2 držáky ručníku



Sifon chromový, Ø 40 mm



rovná hrana zásuvky - dekor dřeva, možnost úchytek



zkosená hrana zásuvky - dekor lak



Standardní skříňka - otevření přitáhnutím



Osvětlení se senzorovým vypínačem



Výřez na sifon v zásuvce 1x



Bez omezení prostoru v zásuvce



Výřez na sifon v zásuvce 2x



Výřez na sifon v zásuvce vlevo



Výřez na sifon v zásuvce vpravo



RIHO CZ, a.s. | Suchý 37 | 680 01 Boskovice | Czech Republic | T: 00420-516 468 222 | E: info@riho.cz
www.riho.cz

042023CZ

Všechna práva vyhrazena! Výrobce nezodpovídá za tiskové chyby a dále si vyhrazuje právo technických a cenových změn.
Veškeré imageové fotografie, technické nákresy produktů a loga společnosti RIHO CZ, a.s. jsou pod ochranou autorských práv.
Tato autorská majetková práva vykonává společnost RIHO CZ, a.s. a bez jejího souhlasu nelze tato autorská díla užit, zejména pak rozmnožovat a rozšiřovat.