













TRÈS







DESIGNED AND PRODUCED IN BARCELONA

2025

CHARACTERISTICS CARATTERISTICHE

-  **N** New
Novita
-  Automatic drain included
Scarico automatico incluso
-  Valvola Simple-Rapid allegata
Simple-Rapid valve included
-  Telescopic shower bar
Scarico automatico incluso
-  Suitable for people with physical disabilities
Indicato per persone con disabilità fisiche
-  Works with electric current
Funziona mediante alimentazione elettrica
-  Works with battery power
Funziona mediante alimentazione con batterie
-  Brass shower head
Soffione in ottone
-  Stainless steel shower head
Soffione in acciaio inox
-  ABS shower head
Soffione in ABS
-  Brass hand shower
Doccia a mano in ottone
-  Stainless steel hand shower
Doccia a mano in acciaio inox
-  ABS hand shower
Doccia a mano in ABS

SPARE PARTS RICAMBI

-  Cartridge (spare part reference)
Cartuccia (numero di riferimento del ricambio)
-  Frame (spare part reference)
Montatura (numero di riferimento del ricambio)
-  Distributor (spare part reference)
Distributore (numero di riferimento del ricambio)
-  Cartridge+Handle (spare part reference)
Cartuccia+Manopola (numero di riferimento del ricambio)

INDICATIONS INDICAZIONI

-  Spout swivel angle
Angolo di rotazione della canna
-  Eccentricità speciale
Special eccentricity
-  Shower head functions (litres/minute)
Funzioni di un soffione (litri/minuto)
-  Hand shower functions (litres/minute)
Funzioni di una doccia a mano (litri/minuto)
-  Jet functions (litres/minute)
Funzioni delle bocchette (litri/minuto)
-  Tempo di apertura (in secondi)
Opening time (in seconds)
-  Freddo (Indicatore della manopola)
Cold (Handle indicator)
-  Caldo (Indicatore della manopola)
Hot (Handle indicator)

TECHNOLOGY TECNOLOGIA

-  Shower with Chromotherapy system
Doccia con sistema di Cromoterapia
-  Cartridge Tres Therm 77®
Cartuccia Tres Therm 77®
-  Cartridge Tres Instant 77®
Cartuccia Tres Instant 77®
-  Cartridge Tres Instant 57®
Cartuccia Tres Instant 57®
-  Touch-Cool®
The surface of the tap is always cold
La superficie del rubinetto è sempre fredda
-  Easy-Clean®
Easy access to and maintenance of the cartridge
Accesso e manutenzione facile della cartuccia
-  Cold-Tres®
The tap always opens with cold water
Il rubinetto si apre sempre con l'acqua fredda
-  Tres-Duo®
The middle position halves the consumption
Nella posizione intermedia si consuma la metà
-  Easy-install®
Easy faucet blockage
Bloccaggio facile del rubinetto



DESIGNED AND PRODUCED IN BARCELONA

2025

The products shown in this catalogue may undergo slight modifications due to design demands, always to the item's benefit.

The prices in this catalogue are recommended retail prices and do not include IVA (VAT).

Given the possibility of printing errors, the revised and definitive prices are always shown on Tres' website.

Please consult the website for product availability.

You can keep up to date with Tres's news or see if a product has been discontinued on this website.

I prodotti del catalogo possono subire qualche modifica per rispondere a esigenze di design, sempre a vantaggio del prodotto.

I prezzi del catalogo sono raccomandati per la vendita al pubblico, IVA non inclusa.

Per evitare eventuali errori di stampa, i prezzi definitivi vengono sempre mostrati sulla pagina web di Tres.

Per sapere la disponibilità dei prodotti, consultare la pagina web.

La pagina web permette di essere sempre aggiornati sulle novità di Tres o di verificare se un prodotto è fuori catalogo.



Tres manufactures **affordable** products in which **design** and **experience** are the focal points, all while **improving water consumption**.

*Tres fabbrica prodotti **accessibili** in cui il **design** e l'**esperienza** sono il pilastro fondamentale e che contribuiscono a rendere più piacevole il **consumo responsabile dell'acqua**.*

CONTENTS CONTENUTO

31 COLLECTIONS COLLEZIONI

Exclusive

- 32 Mont Blanc
- 40 Tres Clasic
- 60 Slim
- 76 Study
- 94 Cuadro

Selection

- 114 Loft
- 128 Fuji
- 140 Project-tres
- 154 Max
- 168 Lex-Alp
- 182 Class

Essential

- 192 Flat
- 204 Canigó Plus
- 216 Canigó
- 228 Base Plus
- 240 Base
- 250 Ese-23

257 SHOWER AREA SPAZIO DOCCIA

Electronic / Elettronici

- 258 Shower technology

Thermostatic systems / Termostatici

- 270 Concealed / *Incassati* B-system
- 280 Concealed / *Incassati* Therm-box
- 294 Surface-mounted / *Da appoggio* Over-wall

Single-lever mixer taps / *Monocomandi*

- 318 Concealed / *Incassati* Rapid-box
- 338 Surface-mounted / *Da appoggio*

347 SHOWER COMPLEMENTS COMPLEMENTI PER DOCCIA

- 354 Shower heads / *Soffioni*

- 371 Hand showers / *Doccini*

- 377 Flexible hoses / *Flessibili*

- 380 Sliding bars / *Barre scorrevoli*

- 390 Shower kits / *Kit per doccia*

- 394 Supports and wall connections / *Staffe e prese a muro*

- 397 Wall elbow adaptors / *Adattatore a gomito a muro*

- 398 Jets / *Getti*

403 CONCEALED SOLUTIONS SOLUZIONI A INCASSO

409 BATHROOM ACCESSORIES ACCESSORI DA BAGNO

- 410 Square / *Quadrato*

- 411 Round / *Rotondo*

- 412 Classic / *Classico*

417 ELECTRONIC TECHNOLOGY TECNOLOGIA ELETTRONICA

- 419 Wash basins / *Lavabi*
- 425 Soap dispensers / *Dispenser di sapone*
- 426 WC sensors / *Sensori WC*
- 426 Hand dryer / *Asciuga mani*
- 427 Kitchen electronic tap / *Cucina elettronica*

429 KITCHEN AREA SPAZIO CUCINA

- 436 Single-lever mixer taps / *Monocomandi*
- 446 For filtered water / *Per acqua filtrata*
- 450 With folding spout / *Con canna a scomparsa*
- 450 With flexible spout / *Con canna flessibile*
- 452 With pull-out spout / *Con canna estraibile*
- 455 Electronic / *Elettronici*
- 456 Two-handle / *Bicomandi*
- 459 Wall-mounted / *A muro*
- 462 Industrial / *Industriali*
- 464 Taps for various uses / *Rubinetti per usi diversi*

467 PUBLIC SPACES STRUTTURE COLLETTIVE

- 468 Outdoor taps / *Rubinetti da esterno*
- 470 Timed taps / *Rubinetti temporizzati*
- 476 Medical taps / *Rubinetti per centri medici*
- 477 Hair salon taps / *Rubinetti per negozio da parrucchiere*
- 478 Taps for various uses / *Rubinetti per usi diversi*

481 TAP COMPLEMENTS COMPLEMENTI DI RUBINETTERIA

- 482 Valves and drains / *Valvole e scarichi*
- 491 Siphons / *Sifoni*
- 495 Shut-off valves / *Valvole di intercettazione*
- 497 Elbow connections / *Raccordi a gomito*
- 499 Spouts / *Canne*
- 501 Escutcheons / *Rosoni*
- 502 Offsets / *Eccentrici*
- 504 WC Systems
 - 506 Filling mechanisms / *Meccanismo di riempimento*
 - 507 Flush mechanisms / *Meccanismo di scarico*
- 510 Tres Cleaner
 - 513 Tapware cleaner / *Detergente per rubinetti*

515 ANNEX ALLEGATO

- 516 Recommended installation / *Installazione consigliata*
- 518 Spare parts / *Ricambi*
- 522 Product list / *Elenco dei riferimenti*
- 534 Terms of sale / *Condizioni di vendita*

COLLECTIONS COLLEZIONI

EXCLUSIVE



SELECTION



ESSENTIAL



SHOWER AREA *SPAZIO DOCCIA*

ELECTRONIC *ELETTRONICI*



Shower technology

THERMOSTATIC *TERMOSTATICI*



B-system

SINGLE-LEVER MIXER *MONOCOMANDI*



Rapid-box



Therm-box



Surface-mounted
Da appoggio



Over-wall

KITCHEN AREA *SPAZIO CUCINA*



Single-lever mixer taps
Monocomandi



For filtered water
Per acqua filtrata



With flexible spout
Con canna flessibile



With pull-out spout
Con canna estraibile



With folding spout
Con canna a scomparsa



Electronic
Elettronici



Two-handle
Bicomandi



Wall-mounted
A muro



Industrial
Industriali



For various uses
Per usi diversi

In order to ensure the maximum quality of its products, Tres controls the entire manufacturing process in its own facilities, from conception of the idea to turning that idea into a reality.

Tres invests in R&D to develop its own technologies and patents and to integrate them in its tapware. Its modern facilities enable research into innovation for showers, environmentally efficient systems and new uses of tapware to adapt to the market demands.

Tres has pioneered the development of tapware with water-saving systems: patented solutions which have been used all over the world. It is also a specialist in thermostatic tapware and researches new ways of experimenting with water in the shower.

Electronics is already a reality in product development. The intuitive use of a contactless washbasin tap, showers which give complete control of the water and temperature, effective water-saving mechanisms, smart taps... All this and more forms part of the bathrooms and kitchens of the future.

Per assicurare la massima sicurezza dei suoi prodotti, Tres controlla l'intero processo di fabbricazione, dal concepimento dell'idea al risultato finale.

Tres investe su R+S al fine di sviluppare le sue tecnologie e i brevetti da integrare nella rubinetteria. I moderni stabilimenti permettono di studiare nuove soluzioni per la doccia, impianti ecoefficienti e nuovi usi della rubinetteria, in linea con le esigenze del mercato.

Tres è un'azienda pioniera nello sviluppo della rubinetteria dotata di un sistema di risparmio idrico e ha brevettato soluzioni utilizzate in tutto il mondo. È specializzata in rubinetteria termostatica e si impegna nella ricerca costante di nuovi modi di utilizzare l'acqua sotto la doccia.

La regolazione elettronica dei miscelatori è ormai una realtà tra i nostri prodotti più recenti e assicurano l'uso intuitivo e contactless dei rubinetti da lavabo, docce che consentono un totale controllo di acqua e temperatura, meccanismi efficaci di risparmio dell'acqua, rubinetti intelligenti... Innovazioni integrate nei bagni e nelle cucine del futuro.

DESIGNED AND
PRODUCED IN
BARCELONA

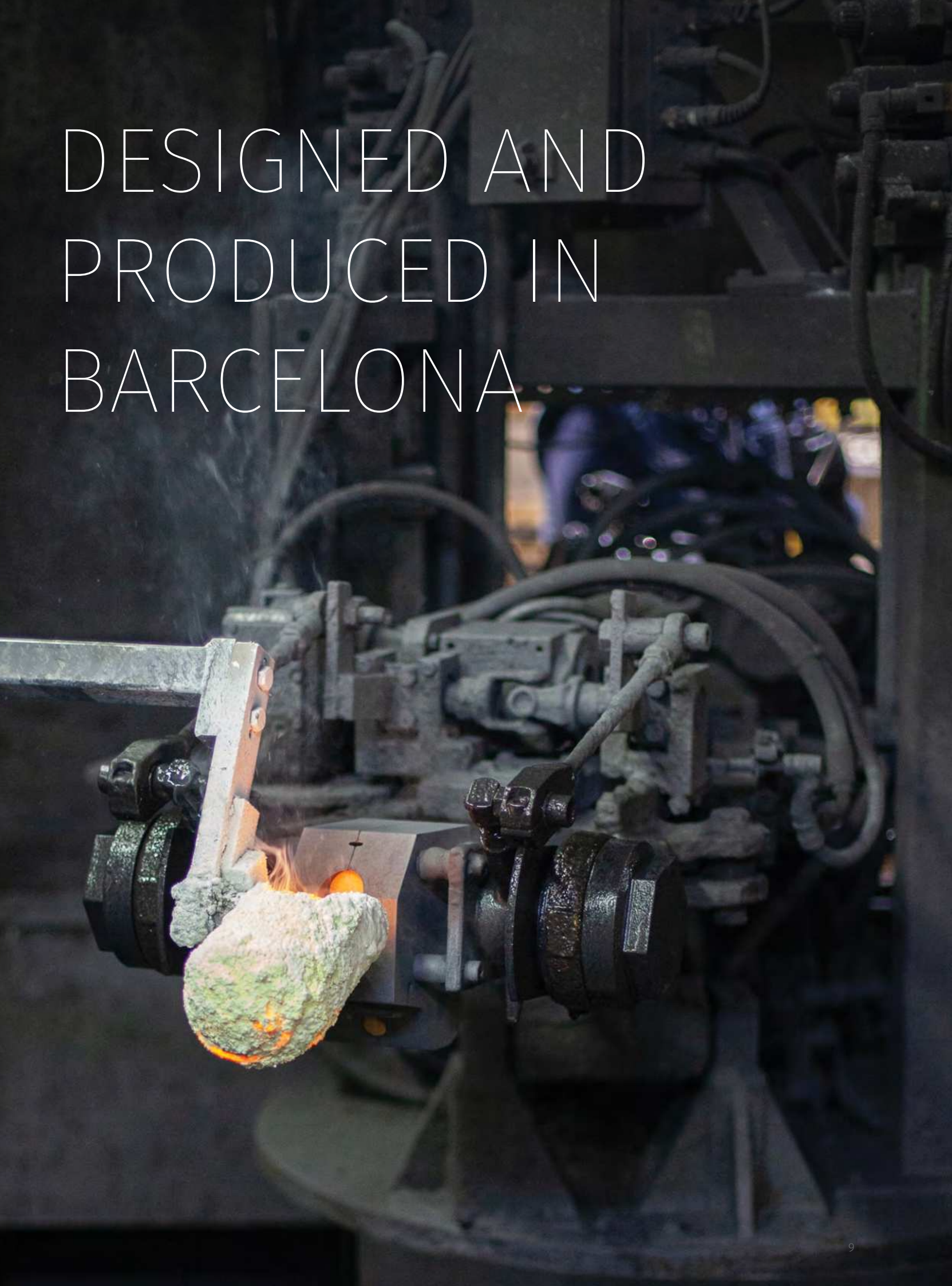

INDUSTRIAL AND INNOVATIVE SPIRIT

SPIRITO INDUSTRIALE E INNOVATIVO



1968

Jaume Tres revolutionised the wine sector by patenting a new barrel tap with a better airtight seal.

Jaume Tres rivoluzionò il settore enologico brevettando un nuovo rubinetto per botti con chiusura ermetica migliorata.

1968

The Tres family opened a small mechanics workshop in Ordal (Barcelona) equipped with second-hand machinery to undertake small repairs for the town, welding jobs for third parties and locksmithing projects.

La famiglia Tres fondò una piccola officina meccanica a Ordal (Barcellona, Spagna), equipaggiandola di macchinari di seconda mano e con l'intenzione di realizzare piccole riparazioni in paese, saldature per terzi o lavorare su commissione per fabbri.



1971

Alongside these workshop jobs, they begin to machine and assemble taps for the wine industry in order to market them under their own brand. They also supply parts to various tapware manufacturers.

Oltre ai lavori tipici da officina, cominciarono a elaborare e montare rubinetti da vino per poterli commercializzare con un marchio proprio. Fornivano inoltre pezzi per vari fabbricanti di rubinetteria.



1972

Their taps for the wine industry became the most profitable part of the business, so they decided to focus exclusively on manufacturing these products and abandoned their repair workshop operations.

L'attività più redditizia era la rubinetteria da vino, per cui decisero di dedicarsi totalmente alla produzione di questi articoli, abbandonando la prestazione di servizi da officina per riparazioni.

1975

A constant learning process and the experience they gained led them to expand their business and include the manufacture of bathroom and kitchen taps. Tres launches its first single lever mixer tap on the Spanish market.

L'apprendistato costante e l'esperienza maturata sfociano nella crescita del volume di affari, nel quale viene inserita la produzione di rubinetteria per bagno e cucina. Tres lancia sul mercato spagnolo il primo rubinetto monocomando.



1985

A decision is made to stop using third parties to produce parts for their taps and the company begins to manufacture its products entirely at its own workshop. Little by little, Tres takes over the entire manufacturing process itself.

Si decide di prescindere dalla produzione esterna di componenti della loro rubinetteria per cominciare a fabbricare interamente in officina. Poco a poco tutto il processo di fabbricazione viene realizzato esclusivamente in Tres.

1993

Tres expands its premises and relocates a part of its production process to Vallirana (very close to the initial factory in Ordal), with a warehouse and office complex of more than 35,000 m².

Tres ingrandisce i propri stabilimenti trasferendo parte della sua produzione a Vallirana (molto vicino alla fabbrica di Ordal) con un complesso di capannoni e officine che occupa più di 35.000 m².

1994

Tres develops and patents one of its most widespread inventions: the first eco-friendly single lever mixer taps in the market. These products effectively save water and energy, and fundamentally changed how the tap industry would approach sustainability.

Tres sviluppa e brevetta una delle sue invenzioni più diffuse: i primi rubinetti monocomando ecologici del mercato che comportano un effettivo risparmio d'acqua ed energia e che influiscono sulla modalità con cui le industrie di rubinetteria affronteranno la questione della sostenibilità.

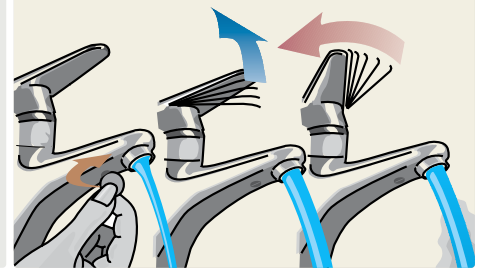

2011

The Jordi Tres Casas Foundation is set up, giving quality jobs to people at risk of social exclusion.

Nasce la Fondazione Jordi Tres Casas che offre lavoro di qualità a persone a rischio di esclusione sociale.

2016

Tres begins to undertake projects focused on new technologies and incorporates electronics into the design of its products.

Tres comincia a lavorare su progetti improntati sulle nuove tecnologie e include l'elettronica nella progettazione dei suoi prodotti.



2025

Discover Tres from the inside:

Esplora Tres da dentro:



RESPONSIBLE INDUSTRY *INDUSTRIA RESPONSABILE*

We want to reduce our impact on the planet as much as possible by manufacturing with quality materials of European origin which comply with the strictest safety standards. We also want to contribute to maintaining a good ecological balance by developing more efficient manufacturing processes, economising transport and applying the recycling, reuse and transformation measures within our reach.

Intendiamo ridurre al massimo il nostro impatto sul pianeta utilizzando materiali di qualità di origine europea, nel rispetto delle più esigenti norme di sicurezza. E desideriamo dare il nostro contributo per mantenere un buon equilibrio ecologico, sviluppando un processo di fabbricazione più efficiente, risparmiando sui trasporti e attuando le misure a nostra disposizione per il riciclo, il riuso e la trasformazione.



Energy self-supply from solar panels.
Autoconsumo di energia attraverso pannelli solari.



Self-produced cardboard packaging to reduce the use of plastics and transport services.
Imballaggio in cartone autoprodotta in vista della riduzione dell'uso di plastica e dei trasporti.



The taps are made from low-lead brass that is refined in Europe according to European Standards (UNE-EN-10204).

I rubinetti sono realizzati in ottone raffinato in Europa, con basso contenuto di piombo, in ottemperanza alla norma europea (UNE-EN 10204).



Tres taps are available in a range of different finishes. All of them are applied via a combination of industrial processes and non-industrial controls to offer a perfect long-lasting result.

La rubinetteria di Tres è disponibile in varie finiture. Tutte vengono applicate attraverso un procedimento industriale intercalato dal controllo artigianale per il raggiungimento di risultati perfetti e duraturi.



Tres offers a guarantee of up to five years on many of our most popular products.

Tres offre fino a 5 anni di garanzia per molti dei prodotti più venduti.



The next-gen laboratory is outfitted for acoustic testing under European Standard EN 200-2008, studying the product to reduce water and energy consumption.

Il nostro laboratorio all'avanguardia è attrezzato per test acustici in conformità alla norma europea EN 200-2008 che permettono di studiare il prodotto per ridurre il consumo di acqua ed energia.



Visual and functional checks on absolutely every part of the pieces, as well as the non-slip rubber seals and non-toxic greases, mean that our products pass all the audits constantly being conducted by official European bodies on our installations.

L'ispezione visiva e funzionale del 100% dei componenti, associata alle gomme non migranti e ai grassi atossici, fa sì che i prodotti superino tutti i controlli realizzati costantemente dagli organismi ufficiali europei presso gli stabilimenti.



Both our products and our production processes are certified by leading certification authorities.

Sia i prodotti che i processi di produzione sono certificati dai principali enti.



①
Design
 Where the collections are devised and the taps are designed.
Design
 Ideazione delle collezioni e progettazione della rubinetteria.

②
Engineering
 Where the product is industrialised and technological improvements are made.
Ingegneria
 Il prodotto viene industrializzato e si apportano miglioramenti tecnologici.

③
Electronics
 Electronic design and programming.
Elettronica
 Progettazione e programmazione elettronica.

④
Foundry
 Where the moulds give shape to the pieces in the brass foundry.
Fusione
 Gli stampi conformano i pezzi attraverso la fusione dell'ottone.



⑤
Machining
 Where we hollow out all the cavities using high-precision machinery.
Elaborazione
 Lavoriamo tutte le cavità con macchinari di alta precisione.



6

Polishers

Where we polish all the surfaces on every tap using robots.

Levigatura

Tutte le superfici di ciascun rubinetto vengono levigate da robot.



7

Baths

Where the pieces are dipped to achieve the final finish.

Bagni

I pezzi prodotti passano alla fase del bagno per essere dotati della finitura definitiva.



8

Assembly

Where the components are installed and the tap is tested before packing.

Montaggio

Si installano i componenti e si verifica il rubinetto per rifinirlo.

9

Laboratory

Where the products undergo exhaustive quality testing in the lab.

Laboratorio

I prodotti vengono sottoposti a test di qualità esaurienti in laboratorio.



10

Packaging

Self-manufacturing of packaging and displays.

Imballaggio

Autofabbricazione di imballaggi ed espositori.

11

Shipping

Where orders are shipped out to destinations all over the world every day.

Spedizione

Gli ordini vengono spediti quotidianamente in tutto il mondo.



TAPS WITH CHARACTER RUBINETTERIA CON PERSONALITÀ

A process capable of guaranteeing quality and durability is needed to achieve all the finishes that Tres offers. This entire industrial process obtains maximum resistance to corrosion and the utmost uniformity on the surface; i.e. a perfect finish. Furthermore, all the pieces are checked and completed by hand to achieve excellence. Given that the entire process takes place at installations owned by Tres, the products maintain the same colour and the same qualities to ensure you always make the right choice.

Tutte le finiture offerte da Tres richiedono lo svolgimento di un procedimento che garantisca qualità e durata. Il procedimento industrializzato a cui sono sottoposti i prodotti li dota di massima resistenza alla corrosione e perfetta uniformità della superficie, per cui la finitura risulta impeccabile. Inoltre, ogni singolo pezzo viene controllato e completato a mano con il proposito di raggiungere l'eccellenza. Poiché l'intero procedimento si svolge negli stabilimenti di Tres, tutti i prodotti presentano la stessa tonalità e le medesime qualità, per cui la scelta di qualsiasi di essi sarà sempre indovinata.



The chrome-plated taps use a Tres-Micron® coating, which offers a perfectly smooth coating over any irregularities on the surface of our pieces. This galvanisation process guarantees outstanding resistance to wear and tear, as well as a lasting shine.

Il rubinetto cromato è provvisto del rivestimento Tres-Micron®, che offre un perfetto livellamento dello spessore sulle superfici irregolari dei singoli pezzi. Questo trattamento galvanico garantisce un'elevata resistenza all'usura con una luminosità duratura e inalterabile.



The chrome plating process involves several steps. The first baths clean the pieces of any grease and dust. The nickel baths then change the colour of the brass. Finally, the electrolysis baths apply the chrome plating to the brass.

Il procedimento di cromatura prevede diverse fasi. I primi bagni servono per l'eliminazione di grasso e polvere; in seguito, i bagni di nichel cambiano il colore dell'ottone; infine, i pezzi sono sottoposti a bagni in cui, mediante elettrolisi, la cromatura viene incorporata nell'ottone.



To create the steel, aged brass (gloss o matte) or metallic black finishes, high-quality tap-suitable epoxy paint is added.

Per realizzare le finiture in acciaio, ottone vecchio (lucido od opacizzato) o nero metallizzato, viene aggiunta vernice epossidica di alta qualità, idonea per rubinetti.



The gold finishes are created using a very similar process to the one for chrome-plating, except that the final step involves a bath in 24 carat gold.

Le finiture in oro sono realizzate con un procedimento molto simile alla cromatura, tranne che nell'ultima fase viene applicata una placcatura in oro 24 carati.



Solvent-free environmentally friendly paint is used to paint pieces in coloured finishes. These finishes include such features as anti-corrosion and durability or stability over time.

Per verniciare i pezzi con finiture colorate, viene utilizzata una vernice ecologica senza solventi; queste finiture incorporano caratteristiche quali anticorrosione e durata o stabilità nel tempo.



For the gold and rose gold finish taps, both gloss and matte, they pass through a bath with real 24 carat gold for a natural look and added value, transforming each tap into a luxurious status symbol.

























Per i rubinetti con finitura oro e oro rosa, sia lucida che opacizzata, viene realizzato un bagno con oro 24 carati autentico; così ogni pezzo acquisisce maggiore naturalezza e valore, e ciascun rubinetto si trasforma in un elemento di lusso.

	CR	Chrome / <i>Cromato</i>
	NM	Matte black / <i>Nero opaco</i>
	BM	Matte white / <i>Bianco opaco</i>
	AC	Steel / <i>Acciaio</i>
	KM	Metallic black / <i>Nero metallizzato</i>
	KMB	Black bronze / <i>Nero bronzato</i>
	OR	Gold 24k / <i>Oro 24k</i>
	OM	Matte gold 24k / <i>Oro opaco 24k</i>
	OP	Rose gold 24k / <i>Oro rosa 24k</i>
	OPM	Matt rose gold 24k / <i>Oro rosa opaco 24k</i>
	LV	Aged brass / <i>Ottone invecchiato</i>
	LM	Matt aged brass / <i>Ottone invecchiato opaco</i>

Tres has poured all its potential into creating unique quality in every product it offers. All the finishes available for its taps are proof of that. The exclusivity, strength and safety of these finishes leads to designer pieces that bring personality and individuality to bathrooms and kitchens.

Tres ha riversato tutto il proprio potenziale per dotare di esclusività ciascun prodotto offerto. Tutte le finiture disponibili per i rubinetti ne sono la prova. L'esclusività, la resistenza e la sicurezza di queste finiture si traducono in pezzi di design che impreziosiscono carattere e individualità del bagno o della cucina.



		CR	NM	BM	AC	KM	KMB	OR	OM	OP	OPM	LV	LM	AM	RO	ME	BL
Mont Blanc		32	•	•	•			•			•						
Tres Clasic		40	•		•			•				•	•				
Slim		60	•	•	•		•	•	•								
Study		76	•	•	•	•	•	•	•	•	•			•	•		
Cuadro		94	•	•	•			•	•							•	•
Loft		114	•	•	•			•	•							•	•
Fuji		128	•	•	•						•						
Project-tres		140	•	•	•	•	•	•	•	•	•						
Max		154	•														
Lex-Alp		168	•														
Class		182	•														
Flat		192	•														
Canigó Plus		204	•														
Canigó		216	•														
Base Plus		228	•	•													
Base		240	•														
Ese-23		250	•														
Shower technology		258	•	•					•		•						
B-system		270	•	•	•			•	•	•	•						
Therm-box		280	•	•	•	•	•	•	•	•	•						
Over-wall		294	•	•	•	•	•		•		•						
Rapid-box		318	•	•	•	•	•	•	•	•	•						
Accessories/Accessori		409	•	•	•	•	•	•	•	•	•	•	•				
Kitchen/Cucina		429	•	•	•	•		•	•			•	•				

TAPS FOR A LIFETIME

RUBINETTI PER TUTTA LA VITA

The durability of Tres products avoids premature obsolescence and reduces environmental impact. The creation of new products considers water and energy saving ideas to offer a safe and efficient product that is also environmentally friendly while maintaining functionality. Tres offers solutions for any installation ready to be adapted to meet the most demanding certification requirements.

La durabilità dei prodotti Tres previene l'obsolescenza prematura, per cui genera un minor impatto ambientale. La creazione dei nuovi prodotti tiene conto del risparmio idrico ed energetico per offrire un prodotto sicuro ed efficiente, rispettoso dell'ambiente senza dover sacrificare la funzionalità. Tres offre soluzioni predisposte per adattarsi alle certificazioni più esigenti per qualsiasi installazione.



Low energy consumption system in which the tap is **always opened with cold water**, avoiding unnecessary switching on of the heater. Designed and patented by Tres since 1992.

*Sistema a basso consumo energetico in cui il rubinetto **si apre sempre con acqua fredda**, evitando inutili accensioni dello scaldabagno. Ideato e brevettato da Tres dal 1992.*



Water saving system with a **two-position handle**. The middle position allows for a 50% water saving. Designed and patented by Tres since 2010.

*Sistema a basso consumo d'acqua con **apertura del rubinetto in due posizioni**. Nella posizione intermedia, si consuma il 50% dell'acqua. Ideato e brevettato da Tres dal 2010.*



Adjustable aerator with 5.7 l/min flow rate limiter for a 50% lower water consumption compared to normal taps, while maintaining maximum comfort.

***Aeratore regolabile** con limitatore di flusso a 5,7 lpm, per consumare meno del 50% di acqua rispetto ai normali rubinetti, mantenendo un utilizzo comodo.*



The taps are made from low-lead brass that is refined in Europe according to European Standards (UNE-EN-10204).

I rubinetti sono realizzati in ottone raffinato in Europa, con basso contenuto di piombo, in ottemperanza alla norma europea (UNE-EN 10204).



Tres-Micron® chrome-plated coating, which guarantees a long-lasting surface, resistance to the passage of time and easy tap cleaning.

Rivestimento con cromatura Tres-Micron®, che garantisce una superficie durevole, resistenza al passaggio del tempo e facilità di pulizia dei rubinetti.



Different height taps that adapt to suit the various sink models available in the market.

Rubinetti di varie altezze che si adattano ai diversi modelli di lavandini presenti sul mercato.

				
BR1	5	5	6	8
BR2	1,9	3,8		6
BR3	-	1,9		

BR flow limiters on the taps, enabling Breeam, Leed and Edge certification.

Limitatore di flusso BR nella rubinetteria che permettono di accedere a certificazioni come Breeam, Leed ed Edge.



Cartridges with ceramic discs that offer smooth lever motion. Designed and patented by Tres, they have a certified lifespan of 200,000 cycles (AENOR-NF).

Cartuccia con dischi in ceramica che garantiscono un funzionamento docile del comando. Progettati e brevettati da Tres, hanno una durata di esercizio certificata di 200.000 cicli (AENOR-NF).



Protec-tres anti-scold system. The cartridge ring enables the maximum temperature to be limited.

Sistema anti-ustione Protec-tres. L'anello della cartuccia consente di limitare la temperatura massima desiderata.

CONCEALED SOLUTIONS *SOLUZIONI A INCASSO*

Recessed taps are partly installed inside the wall, leaving only the essential parts visible to the user. This type of installation is perfect for a more discreet or minimalistic bathroom design, providing a greater sense of airy spaciousness. At Tres, we have several different internal bodies for recessing every type of tap we produce.

La rubinetteria a incasso viene installata internamente, nella parete, per cui resta visibile solo la parte essenziale. Questo tipo di installazione è perfetta per le sale da bagno in cui si ricerca un design più discreto o minimalista per offrire una sensazione di maggiore ampiezza e leggerezza. In Tres disponiamo di vari corpi interni per incassare qualsiasi tipo di rubinetteria.



→65, 72, 82, 89, 404

Floor-standing taps
Sink or bath taps that are installed on the floor

Rubinetteria autoportante
Rubinetti per lavabo o vasca da bagno installati con attacco a pavimento



→405

Wall-mounted washbasins
Built-in single lever mixer tap for the sink

Lavabi a muro
Rubinetti monocomando a incasso per il lavabo

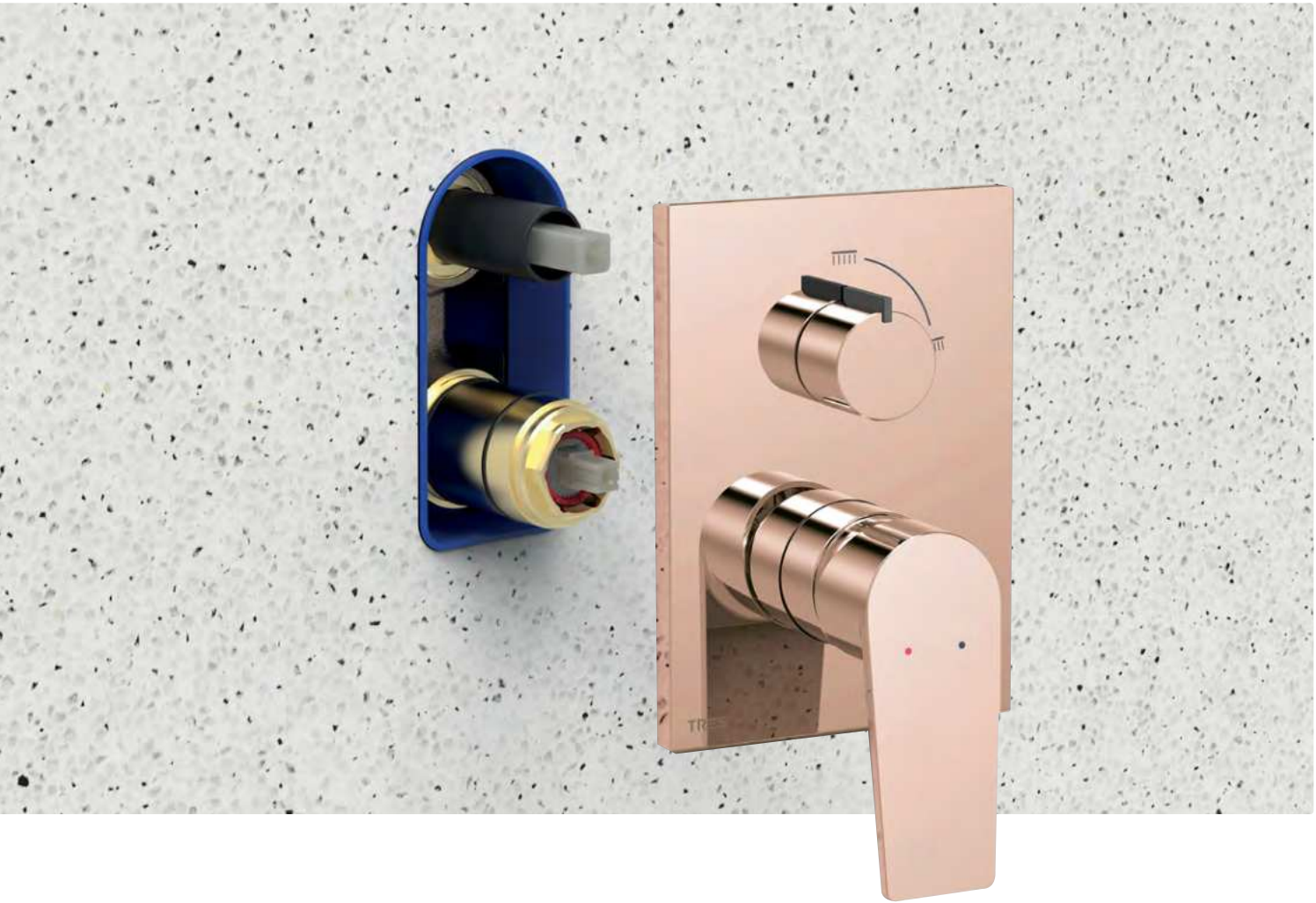

→258

Shower technology

Electronic thermostatic kits with 2, 3 or 4 outlets for the shower

Kit termostatici elettronici da 2, 3 o 4 vie per la doccia



→270

B-system

Built-in thermostatic kits with 2, 3 or 4 outlets for the shower

Kit termostatici a incasso da 2, 3 o 4 vie per la doccia



→280

Therm-box

Built-in thermostatic kits with 2 outlets for the shower

Kit termostatici a incasso da 2 vie per la doccia



→318

Rapid-box

Built-in single lever mixer tap kits with 1, 2 or 3 outlets for the shower

Kit monocomando a incasso a 1, 2 o 3 vie per la doccia

QUALITY AND TOTAL CONTROL *QUALITÀ E CONTROLLO TOTALE*

Thermostatic taps automatically mix hot and cold water to constantly maintain the desired temperature while also regulating water flow. Thermostatic taps minimise water wastage and maximise energy efficiency. Their specifications give you total control over your water and guarantee a complete shower experience.

I rubinetti termostatici miscelano automaticamente acqua calda e acqua fredda fino a ottenere la temperatura scelta che mantengono costante, oltre a regolarne il flusso. Il rubinetto termostatico è la soluzione che provoca il minor spreco dell'acqua e che meglio ottimizza l'energia. Le sue caratteristiche permettono di esercitare un controllo totale dell'acqua e garantiscono che la doccia si converta in un'esperienza totale.



Aerated or waterfall bath taps.

Rubinetti per vasca da bagno disponibili con uscita dell'acqua aerata o tipo a cascata.



Shower or bath taps with hand shower, support and flexo hose.

Rubinetti per doccia o vasca da bagno con doccia a mano, supporto e flessibile.



Aerated or waterfall triple-output sets for the bath.

Set di 3 vie per vasca da bagno con uscita dell'acqua aerata o tipo a cascata.



More variety in terms of dual-output sets for the shower.

Ulteriore varietà di set a 2 vie per la doccia.



Touch-cool

The internal water circuit makes the cold water come in contact with the surface, meaning **the tap stays cool when touched and preventing burns.**

*Il circuito interno dell'acqua fa in modo che sia l'acqua fredda a toccare la superficie e in questo modo **il rubinetto rimane sempre freddo al tatto, evitando bruciature.***



Easy-clean

Tres offers the possibility of **cleaning the cartridge easily** in the event of blockage, without losing its calibration.

*Tres offre la possibilità di **pulire facilmente la cartuccia** in caso di ingorgo senza perderne la calibratura.*



Instant

The cartridge ensures a **constant flow of water** at the desired temperature ± 1 degree, in spite of pressure and/or temperature changes. Designed for Legionella disinfection.

*La cartuccia assicura una **portata d'acqua costante** alla temperatura desiderata di ± 1 grado in caso di variazioni di pressione e/o temperatura. Concepita per la disinfezione dalla legionella.*

Lever designs

The B-system, Therm-box and Over-wall shower collections come with levers in different shapes and sizes to combine with all the other Tres collections so your bathroom can perfectly embody your initial ideas.

Progettazione di volantini

Le collezioni da doccia B-System, Therm-box e Over-wall dispongono di volantini di varie forme che si abbinano al resto delle collezioni di Tres e dunque permettono di completare il bagno con design adattabili.

		B-SYSTEM	THERM-BOX	OVER-WALL
	Square Quadrata		•	•
	Square-round Quadrata-rotonda	•	•	•
	Round Rotonda	•	•	•
	Rounded edges Bordi arrotondati			•
	Oval Ovale		•	•
	Crossed A croce		•	

REPLACES THE BIDET AND MAKES GOOD USE OF SPACE

SOSTITUISTE IL BIDET E APPROFITTATE DELLO SPAZIO

Replaces the traditional bidet with a tap that takes advantage of the toilet bowl. Simple to install, and does not occupy any space. You can opt for an embedded mixer tap with integrated shower/bidet support, or else use the wash basin tap with a specific outlet for the shower-bidet. Two options to adapt to new spaces and bring your bathroom up to date.

Sostituisci il bidet tradizionale con un rubinetto da incorporare nel water. L'installazione è semplice e non occupa spazio. Si può scegliere un rubinetto monocomando incassato con supporto per doccia/bidet incorporato o utilizzare il rubinetto del lavandino con apposita uscita per la doccia/bidet. Due opzioni da adattare ai nuovi spazi per riformulare l'arredo bagno.

















Built-in mixer tap with integrated shower-bidet support.
Monocomando miscelatore incassato con supporto doccia-bidet integrato.



Special bathroom mixer tap with a dedicated shower-bidet outlet; easy to install using the water outlet shared with the sink mixer tap.

Monocomando speciale da lavabo con un'uscita specifica per la doccia-bidet: installazione semplice utilizzando la presa d'acqua condivisa con il monocomando del lavabo.

	Study Max	134123 134122*	→84 →160	
	Cuadro	00612301 00612302*	→103	
	Loft	20522301 20522201*	→121	
	Fuji	28112301	→134	
	Lex	181223 181222*	→174	
	Canigó	21712301	→220	
	Lex	181113	→174	

* Option for plasterboard walls. / *Opzione per pareti in cartongesso.*

KITCHENS FOR EVERY TASTE CUCINE PER TUTTI I GUSTI



Cold-tres system: the tap always opens with cold water in the central lever position and the user can decide whether or not to use hot water, thereby reducing energy and water consumption.

Sistema Cold-tres: all'apertura, con la leva in posizione centrale, il rubinetto eroga sempre acqua fredda così l'acqua calda viene utilizzata solo con una decisione consapevole e si consumano meno energia e acqua.



The base is built-in to the tap body, making installation and surface cleaning easier.
Base incorporata che agevola l'installazione del rubinetto e la pulizia del ripiano.



All kitchen taps incorporate the Easy-install system, reinforced tap anchoring with a simple movement.

In tutti i rubinetti da cucina è incorporato il sistema di fissaggio Easy-install, supporto rinforzato del rubinetto che si attiva con un semplice movimento.



New tap models with a folding spout. The total height with the spout folded away is only 6 cm.

Nuovi modelli di rubinetti con beccuccio pieghevole. Altezza totale con beccuccio piegato di soli 6 cm.



The lever is located at a particular height above the countertop for greater comfort.

Leva posizionata a un'altezza speciale rispetto al ripiano per maggiore comodità.



Electronic tap activated by an infra-red sensor. Sensor-based flow control. Temperature adjustment using a handle on the body.
Rubinetto elettronico azionato da sensore a infrarossi. Regolazione del flusso mediante sensore. Regolazione della temperatura tramite volantino situato sul corpo.



Two stream modes (aerator or shower effect) that are selected using a button.
2 tipi di getto (effetto aeratore o doccia) azionati da pulsante.



Magnetic attachment of spout to the support.
Fissaggio del beccuccio al supporto tramite magnete.



A single tap for mains and filtered water. With a touch system for filtered water.
Un solo rubinetto per acqua di rete di erogazione e acqua filtrata. Con sistema tattile per acqua filtrata.



The Seven+ purifier filter from Tres provides unbeatable protection against the contaminants and viruses present in water, as well giving you water that tastes good.
Il filtro purificante Seven+ di Tres offre una protezione insuperabile contro gli elementi contaminanti e i virus presenti nell'acqua, oltre a donare un buon sapore all'acqua.



A range of taps for filtered water in special finishes for combination with other taps.
Varietà di rubinetti per acqua filtrata con finiture speciali da combinare con il resto della rubinetteria.





32 Mont Blanc

40 Tres Clasic

60 Slim

76 Study

94 Cuadro

114 Loft

128 Fuji

140 Project-tres

154 Max

168 Lex-Alp

182 Class

192 Flat

204 Canigó Plus

216 Canigó

228 Base Plus

240 Base

250 Ese-23



MONT BLANC

The Mont Blanc collection by Tres is based on a symmetrical architecture, built on the premises of design, functionality and attention to detail. With the characteristic cross-shaped handles, this update of the classic design allows more adaptability and turns the pieces into something timeless and authentic.

La collezione Mont Blanc di Tres si basa su un'architettura simmetrica costruita sulle premesse di design, funzionalità e attenzione ai dettagli. Con le caratteristiche manopole a forma di croce, questa revisione dell'estetica classica permette una maggiore adattabilità e rende i tuoi pezzi senza tempo e autentici.

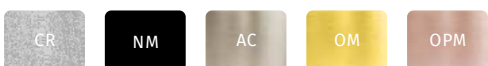







WASHBASIN TAPS / RUBINETTI PER LAVABO

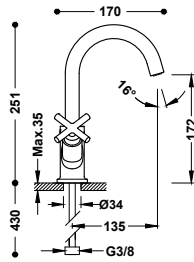

Two-handle washbasin mixer tap

With handles. G3/8 flexible hoses.

Miscelatore bicomando per lavabo

Con manopole. Flessibili di alimentazione G3/8.

28310301	236,00
28310301NM	366,00
28310301AC	366,00
28310301OM	520,00
28310301OPM	520,00

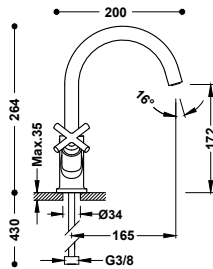
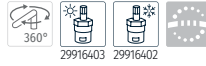

High two-handle washbasin mixer tap

With handles. G3/8 flexible hoses.

Miscelatore bicomando alto per lavabo

Con manopole. Flessibili di alimentazione G3/8.

28320301	252,00
28320301NM	391,00
28320301AC	391,00
28320301OM	554,00
28320301OPM	554,00

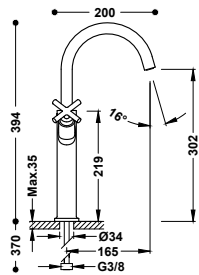
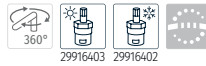

XXL two-handle washbasin mixer tap

With handles. G3/8 flexible hoses.

Miscelatore bicomando XXL per lavabo

Con manopole. Flessibili di alimentazione G3/8.

28380301	294,00
28380301NM	456,00
28380301AC	456,00
28380301OM	647,00
28380301OPM	647,00

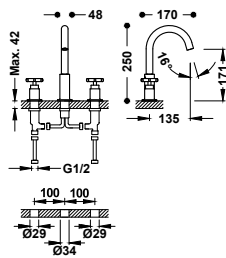
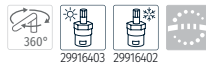

Deck-mounted 3-hole basin mixer

Can be freely installed. With handles.

Miscelatore bicomando bordo lavabo

Libera installazione. Con manopole.

28310501	315,00
28310501NM	488,00
28310501AC	488,00
28310501OM	693,00
28310501OPM	693,00

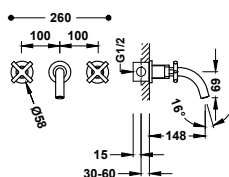

3-hole concealed basin mixer

Fitted and indivisible body included. With handles. 148 mm spout.

Miscelatore bicomando a incasso per lavabo

Corpo a incasso incluso e indivisibile. Con manopole. Canna da 148 mm.

28330001	289,00
28330001NM	448,00
28330001AC	448,00
28330001OM	635,00
28330001OPM	635,00



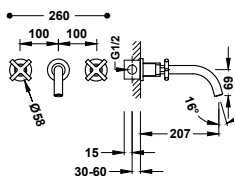

3-hole concealed basin mixer

Fitted and indivisible body included. With handles. 207 mm spout.

Miscelatore bicomando a incasso per lavabo

Corpo a incasso incluso e indivisibile. Con manopole. Canna da 207 mm.

■ 28330002	299,00
■ 28330002NM	464,00
■ 28330002AC	464,00
■ 28330002OM	658,00
■ 28330002OPM	658,00



BIDET TAPS / RUBINETTI PER BIDET

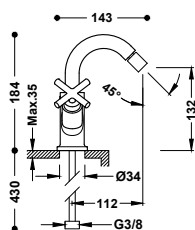

Two-handle bidet mixer tap

Adjustable shower head. With handles. G3/8 flexible hoses.

Miscelatore bicomando per bidet

Supporto orientabile. Con manopole. Flessibili di alimentazione G3/8.

■ 28312001	239,00
■ 28312001NM	371,00
■ 28312001AC	371,00
■ 28312001OM	527,00
■ 28312001OPM	527,00



WALL TAPS / RUBINETTI A MURO

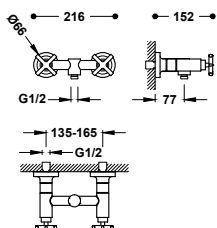

Wall-mounted two-handle shower mixer tap

Anti-limescale brass hand shower. Adjustable support for hand shower. Satin hose.

Miscelatore bicomando a muro per doccia

Doccino anticalcare in ottone. Supporto orientabile per doccino. Flessibile satinato.

■ 28316301	336,00
■ 28316301NM	521,00
■ 28316301AC	521,00
■ 28316301OM	739,00
■ 28316301OPM	739,00

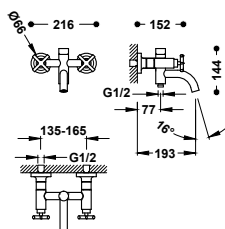

Wall-mounted two-handle mixer tap for bath and shower

Anti-limescale brass hand shower. Adjustable support for hand shower. Satin hose.

Miscelatore bicomando a muro per vasca e doccia

Doccino anticalcare in ottone. Supporto orientabile per doccino. Flessibile satinato.

■ 28317601	404,00
■ 28317601NM	627,00
■ 28317601AC	627,00
■ 28317601OM	889,00
■ 28317601OPM	889,00





BATH TAPS / RUBINETTI PER VASCA

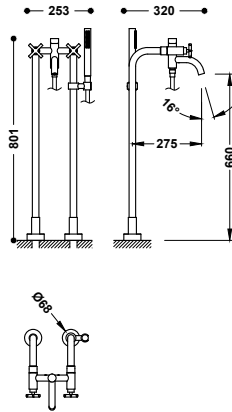

Floor-mounted two-handle mixer tap for bath and shower

2 floor-mounted vertical water supply columns. Anti-limescale brass hand shower. Fixed support for hand shower. Satin hose.

Miscelatore bicomando da pavimento per vasca e doccia

Con 2 colonne verticali di alimentazione dell'acqua a terra. Doccino anticalcare in ottone. Supporto fisso per doccia. Flessibile satinato.

28319401	578,00
28319401NM	895,00
28319401AC	895,00
28319401OM	1.271,00
28319401OPM	1.271,00

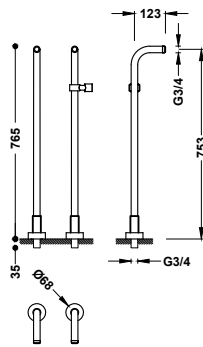

Elbow water connectors for floor installation for bath tap

2 units with fixed support for hand shower.

Prese d'acqua a gomito da terra per miscelatore della vasca

2 unità con supporto fisso per doccia.

161194	310,00
161194NM	481,00
161194AC	481,00
161194OM	682,00
161194OPM	682,00

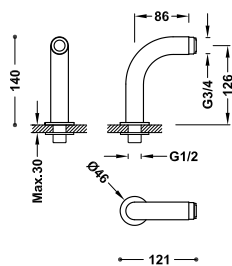

Elbow water connectors for installation on bath edge for bath tap

2 units with silencer.

Prese d'acqua a gomito bordo vasca per miscelatore della vasca

2 unità con silenziatore.

29987001	114,00
29987001NM	177,00
29987001AC	177,00
29987001OM	251,00
29987001OPM	251,00

CONCEALED TAPS/ RUBINETTI DA INCASSO

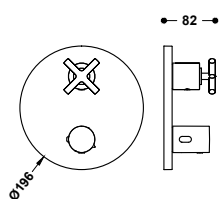

Visible part for concealed 2-way Therm-box

Only visible part. Crossed handle. Includes trim plate, control and distribution handle. Complete with concealed Therm-box ref.: 20785001.

Pezzo vista per cassa da incasso a 2 vie Therm-box

Solo parte vista. Manopola a croce. Include piastra decorativa, comando e volante distributore. Completare con scatola da incasso Therm-box rif.: 20785001.

28325001	179,00
28325001NM	277,00
28325001AC	277,00
28325001OM	393,00
28325001OPM	393,00



Therm-box 2-way concealed box with thermostatic tap for shower and bathtub

20785001	130,00
----------	--------

Scatola da incasso a 2 getti Therm-box con miscelatore termostatico per doccia e vasca da bagno

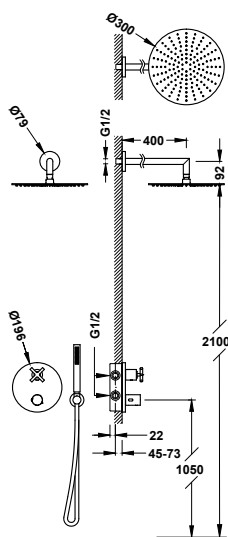

Therm-box 2-way concealed thermostatic tap kit for showers

- Concealed body included.
- Crossed handle with temperature control. 2-way ceramic distributor.
- Wall-mounted arm with adjustable stainless steel shower head: Ø 300 mm.
- Wall-mounted support for hand shower with water supply.
- Anti-limescale brass hand shower.
- Satin hose.

Kit di miscelatore termostatico da incasso a 2 getti Therm-box per doccia

- Corpo a incasso incluso.
- Manopola a croce con controllo della temperatura. Erogatore in ceramica a 2 getti.
- Braccio a muro con soffione doccia orientabile in acciaio inossidabile: Ø 300 mm.
- Supporto per doccia con presa d'acqua a muro.
- Doccino anticalcare in ottone.
- Flessibile satinato.

28325002	625,00
28325002NM	899,00
28325002AC	899,00
28325002OM	1.224,00
28325002OPM	1.224,00



29926828



SHUT-OFF VALVES / VALVOLE DI INTERCETTAZIONE

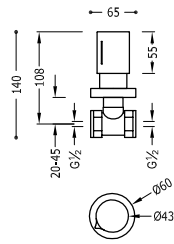

Concealed shut-off valve

Female thread connection: 1/2".

Valvola di intercettazione a incasso

Attacco a filetto femmina: 1/2".

06115501	83,00
06115501NM	128,00
06115501BM	128,00
06115501AC	128,00
06115501KM	128,00
06115501KMB	128,00
06115501OR	182,00
06115501OM	182,00
06115501OP	182,00
06115501OPM	182,00

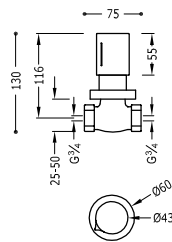

Concealed shut-off valve

Female thread connection: 3/4".

Valvola di intercettazione a incasso

Attacco a filetto femmina: 3/4".

06151101	91,00
06151101NM	140,00
06151101BM	140,00
06151101AC	140,00
06151101KM	140,00
06151101KMB	140,00
06151101OR	199,00
06151101OM	199,00
06151101OP	199,00
06151101OPM	199,00



TRES CLASIC

Its design takes inspiration from classic tapware but it is equipped with the latest technology. The Clasic collection by Tres creates the rustic, classic and elegant ambience that you are looking for. The special finishes available for this model are the perfect option for adding the finishing touches to an inspiring bathroom.

Il suo design si ispira alla rubinetteria classica ma dotato di tecnologia odierna. Con la collezione Clasic di Tres ottieni l'atmosfera rustica, classica ed elegante che stai cercando. Le finiture speciali che presenta sono perfette per completare un bagno d'ispirazione.







WASHBASIN TAPS / RUBINETTI PER LAVABO

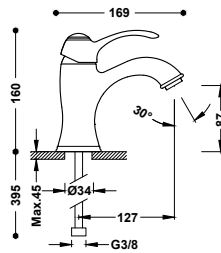

Single-handle washbasin mixer tap

G3/8 flexible hoses.

Miscelatore monocomando per lavabo

Flessibili di alimentazione G3/8.

	24210301	215,00
	24210301AC	334,00
	24210301OR	474,00
	24210301LV	312,00
	24210301LM	312,00

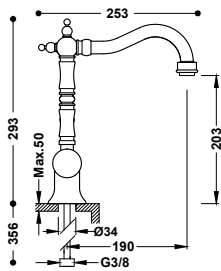

Single-handle washbasin mixer tap with lateral lever

G3/8 flexible hoses.

Miscelatore monocomando con leva laterale per lavabo

Flessibili di alimentazione G3/8.

	24210801	252,00
	24210801AC	391,00
	24210801OR	554,00
	24210801LV	365,00
	24210801LM	365,00

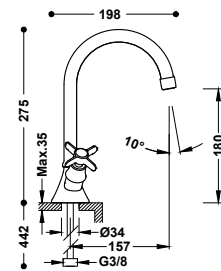

Two-handle washbasin mixer tap

With handles. G3/8 flexible hoses.

Miscelatore bicomando per lavabo

Con manopole. Flessibili di alimentazione G3/8.

	24210901	179,00
	24210901AC	277,00
	24210901OR	393,00
	24210901LV	259,00
	24210901LM	259,00

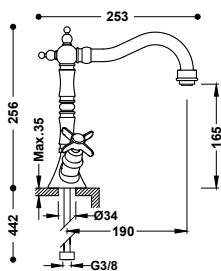

Two-handle washbasin mixer tap

With handles. G3/8 flexible hoses.

Miscelatore bicomando per lavabo

Con manopole. Flessibili di alimentazione G3/8.

	24210902	278,00
	24210902AC	431,00
	24210902OR	612,00
	24210902LV	403,00
	24210902LM	403,00

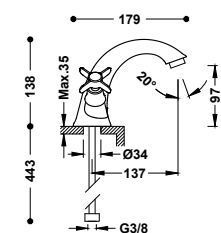

Two-handle washbasin mixer tap

With handles. G3/8 flexible hoses.

Miscelatore bicomando per lavabo

Con manopole. Flessibili di alimentazione G3/8.

	24210201	273,00
	24210201AC	423,00
	24210201OR	601,00
	24210201LV	396,00
	24210201LM	396,00

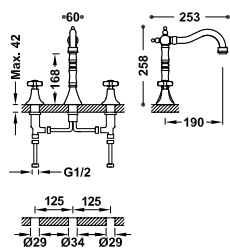

Deck-mounted 3-hole basin mixer

Can be freely installed. With handles.

Miscelatore bicomando bordo lavabo

Libera installazione. Con manopole.



24210501	383,00
24210501AC	594,00
24210501OR	843,00
24210501LV	556,00
24210501LM	556,00

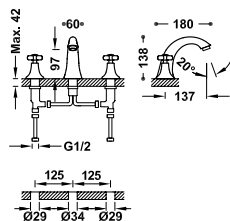

Deck-mounted 3-hole basin mixer

Can be freely installed. With handles.

Miscelatore bicomando bordo lavabo

Libera installazione. Con manopole.



24210601	326,00
24210601AC	505,00
24210601OR	716,00
24210601LV	472,00
24210601LM	472,00

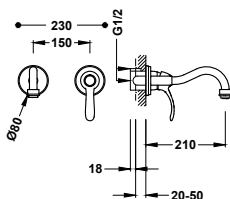

Concealed single-handle washbasin mixer tap

Fitted and indivisible body included. 210 mm spout.

Miscelatore monocomando a incasso per lavabo

Corpo a incasso incluso e indivisibile. Canna da 210 mm.



24220001	263,00
24220001AC	407,00
24220001OR	578,00
24220001LV	381,00
24220001LM	381,00

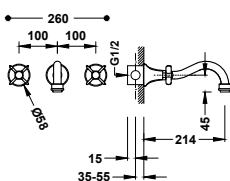

3-hole concealed basin mixer

Fitted and indivisible body included. With handles. 214 mm spout.

Miscelatore bicomando a incasso per lavabo

Corpo a incasso incluso e indivisibile. Con manopole. Canna da 214 mm.



24215101	284,00
24215101AC	439,00
24215101OR	624,00
24215101LV	411,00
24215101LM	411,00

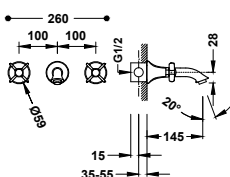

3-hole concealed basin mixer

Fitted and indivisible body included. With handles. 145 mm spout.

Miscelatore bicomando a incasso per lavabo

Corpo a incasso incluso e indivisibile. Con manopole. Canna da 145 mm.



24215102	305,00
24215102AC	472,00
24215102OR	670,00
24215102LV	442,00
24215102LM	442,00

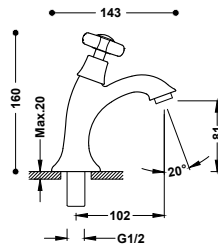

Washbasin tap with 1 water outlet
 With G1/2 threaded connection
Rubinetto monoacqua per lavabo
 Con attacco filettato da G1/2



	24250301	104,00
	24250301AC	156,00
	24250301OR	222,00
	24250301LV	146,00
	24250301LM	146,00

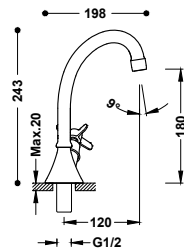

Washbasin tap with 1 water outlet and lateral handle
 With G1/2 threaded connection
Miscelatore monoacqua con manopola laterale per lavabo
 Con attacco filettato da G1/2



	24230601	106,00
	24230601AC	164,00
	24230601OR	233,00
	24230601LV	154,00
	24230601LM	154,00

BIDET TAPS / RUBINETTI PER BIDET

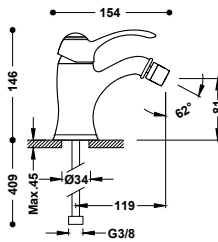

Single-handle bidet mixer tap
 Adjustable shower head. G3/8 flexible hoses.
Miscelatore monocomando per bidet
 Supporto orientabile. Flessibili di alimentazione G3/8.



	24212001	226,00
	24212001AC	350,00
	24212001OR	497,00
	24212001LV	327,00
	24212001LM	327,00

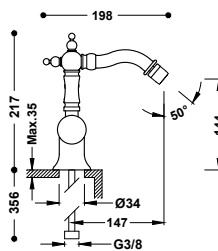

Single-handle bidet mixer tap with lateral lever
 Adjustable shower head. G3/8 flexible hoses.
Miscelatore monocomando con leva laterale per bidet
 Supporto orientabile. Flessibili di alimentazione G3/8.



	24222001	255,00
	24222001AC	395,00
	24222001OR	561,00
	24222001LV	370,00
	24222001LM	370,00

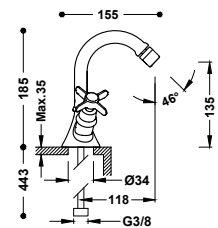

Two-handle bidet mixer tap
 Adjustable shower head. With handles. G3/8 flexible hoses.
Miscelatore bicomando per bidet
 Supporto orientabile. Con manopole. Flessibili di alimentazione G3/8.



	24212201	186,00
	24212201AC	288,00
	24212201OR	409,00
	24212201LV	269,00
	24212201LM	269,00

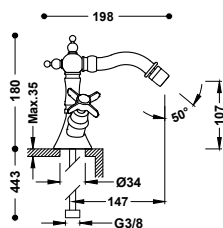

Two-handle bidet mixer tap

Adjustable shower head. With handles. G3/8 flexible hoses.

Miscelatore bicomando per bidet

Supporto orientabile. Con manopole. Flessibili di alimentazione G3/8.



24212202	289,00
24212202AC	448,00
24212202OR	635,00
24212202LV	419,00
24212202LM	419,00

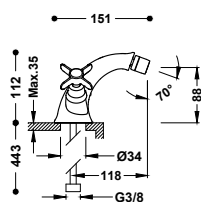

Two-handle bidet mixer tap

Adjustable shower head. With handles. G3/8 flexible hoses.

Miscelatore bicomando per bidet

Supporto orientabile. Con manopole. Flessibili di alimentazione G3/8.



24212101	284,00
24212101AC	439,00
24212101OR	624,00
24212101LV	411,00
24212101LM	411,00

WALL TAPS / RUBINETTI A MURO

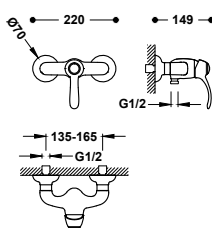

Wall-mounted single-handle shower mixer tap

Anti-limescale brass hand shower: Ø 78 mm. Adjustable support for hand shower. Reinforced metal hose.

Miscelatore monocomando a muro per doccia

Doccino anticalcare in ottone: Ø 78 mm. Supporto orientabile per doccino. Flessibile rinforzato in metallo.



24216701	305,00
24216701AC	472,00
24216701OR	670,00
24216701LV	442,00
24216701LM	442,00

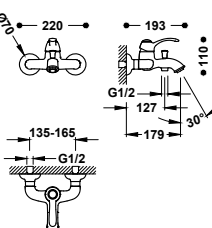

Wall-mounted single-handle mixer tap for bath and shower

Anti-limescale brass hand shower: Ø 78 mm. Adjustable support for hand shower. Reinforced metal hose.

Miscelatore monocomando a muro per vasca e doccia

Doccino anticalcare in ottone: Ø 78 mm. Supporto orientabile per doccino. Flessibile rinforzato in metallo.



24217001	352,00
24217001AC	545,00
24217001OR	774,00
24217001LV	510,00
24217001LM	510,00

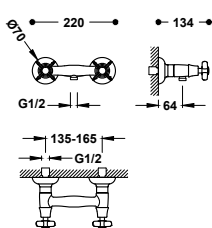

Wall-mounted two-handle shower mixer tap

Anti-limescale brass hand shower: Ø 78 mm. Adjustable support for hand shower. Reinforced metal hose.

Miscelatore bicomando a muro per doccia

Doccino anticalcare in ottone: Ø 78 mm. Supporto orientabile per doccino. Flessibile rinforzato in metallo.



24216301	294,00
24216301AC	456,00
24216301OR	647,00
24216301LV	426,00
24216301LM	426,00

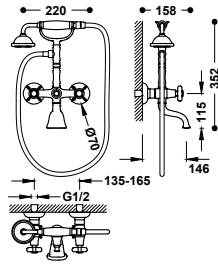

Wall-mounted two-handle mixer tap for bath and shower

Anti-limescale brass hand shower: Ø 78 mm. Fixed support for hand shower. Reinforced metal hose.

Miscelatore bicomando a muro per vasca e doccia

Doccino anticalcare in ottone: Ø 78 mm. Supporto fisso per doccino. Flessibile rinforzato in metallo.

■	24217601	436,00
■	24217601AC	675,00
■	24217601OR	959,00
■	24217601LV	632,00
■	24217601LM	632,00

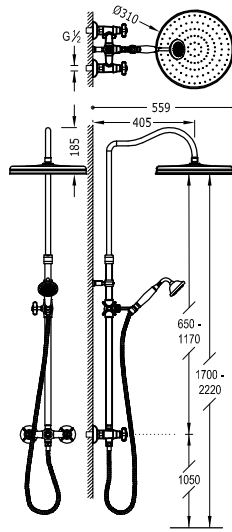
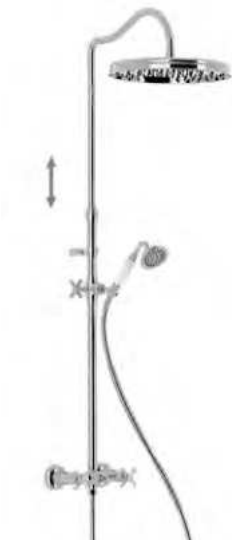
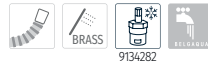

2-way wall-mounted two-handle shower mixer tap set

- Telescopic shower bar.
- Adjustable brass shower head: Ø 310 mm.
- Adjustable and sliding support for hand shower.
- Anti-limescale brass hand shower: Ø 78 mm.
- Reinforced metal hose.

Set di miscelatore bicomando a muro 2 getti per doccia

- Colonna doccia telescopica.
- Soffione doccia orientabile in ottone: Ø 310 mm.
- Supporto scorrevole e orientabile per doccino.
- Doccino anticalcare in ottone: Ø 78 mm.
- Flessibile rinforzato in metallo.

■	24219101	1.003,00
■	24219101AC	1.555,00
■	24219101LV	1.454,00
■	24219101LM	1.454,00

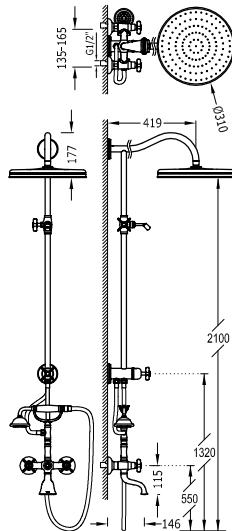
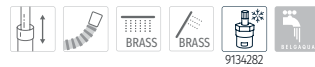

3-way wall-mounted two-handle mixer tap set for bath and shower

- With diverter integrated into the shower bar.
- Adjustable brass shower head: Ø 310 mm.
- Adjustable and sliding support for hand shower.
- Anti-limescale brass hand shower: Ø 78 mm.
- Reinforced metal hose.

Set di miscelatore bicomando a muro 3 getti per vasca e doccia

- Con inverter incorporato nella colonna doccia.
- Soffione doccia orientabile in ottone: Ø 310 mm.
- Supporto scorrevole e orientabile per doccino.
- Doccino anticalcare in ottone: Ø 78 mm.
- Flessibile rinforzato in metallo.

■	24217602	890,00
■	24217602AC	1.380,00
■	24217602LV	1.291,00
■	24217602LM	1.291,00

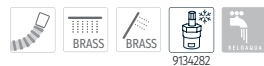

CONCEALED TAPS/ RUBINETTI DA INCASSO

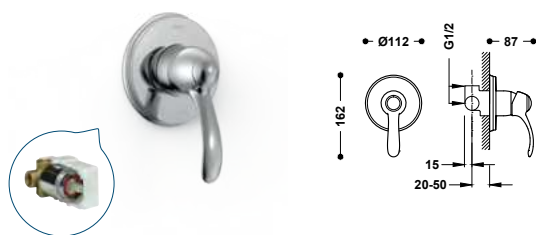

1-way concealed single-handle shower mixer tap

Concealed body included.

Miscelatore monocomando a incasso 1 getto per doccia

Corpo a incasso incluso.



24217701	116,00
24217701AC	179,00
24217701OR	254,00
24217701LV	167,00
24217701LM	167,00

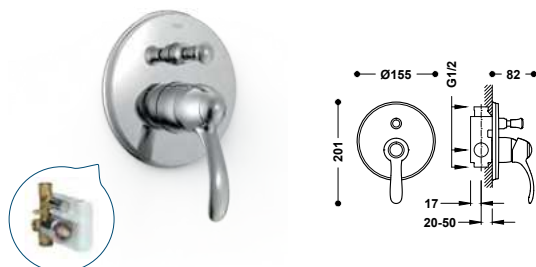

2-way concealed single-handle shower mixer tap

Concealed body included. 2-way diverter.

Miscelatore monocomando a incasso 2 getti per doccia

Corpo a incasso incluso. Inverter a 2 getti.



24218001	179,00
24218001AC	277,00
24218001OR	393,00
24218001LV	259,00
24218001LM	259,00

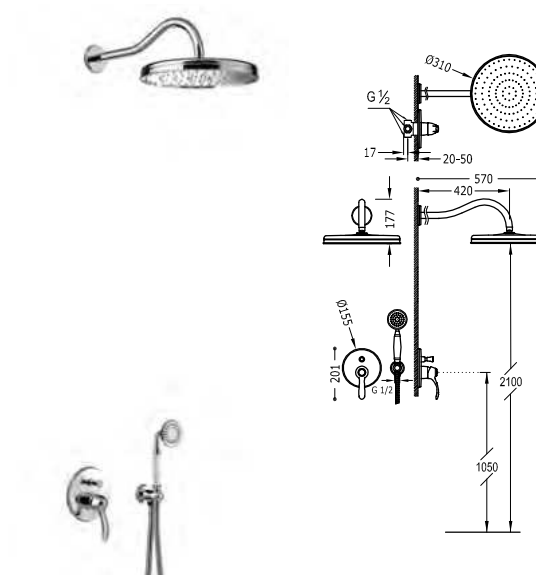

2-way concealed single-handle shower mixer tap kit

- Concealed body included.
- 2-way diverter.
- Wall-mounted arm with adjustable brass shower head: Ø 310 mm.
- Wall-mounted support for hand shower with water supply.
- Anti-limescale brass hand shower: Ø 78 mm.
- Reinforced metal hose.

Kit di miscelatore monocomando a incasso 2 getti per doccia

- Corpo a incasso incluso.
- Inverter a 2 getti.
- Braccio a muro con soffione doccia orientabile in ottone: Ø 310 mm.
- Supporto per doccia con presa d'acqua a muro.
- Doccino anticalcare in ottone: Ø 78 mm.
- Flessibile rinforzato in metallo.

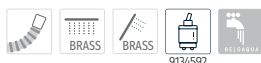

24218003	638,00
24218003AC	991,00
24218003OR	1.480,00
24218003LV	925,00
24218003LM	925,00



2-way concealed single-handle shower mixer tap kit

- Concealed body included.
- 2-way diverter.
- Ceiling-mounted arm with brass adjustable shower head: Ø 310 mm.
- Wall-mounted support for hand shower with water supply.
- Anti-limescale brass hand shower: Ø 78 mm.
- Reinforced metal hose.

Kit di miscelatore monocomando a incasso 2 getti per doccia

- Corpo a incasso incluso.
- Inverter a 2 getti.
- Braccio a soffitto con soffione doccia orientabile in ottone: Ø 310 mm.
- Supporto per doccia con presa d'acqua a muro.
- Doccino anticalcare in ottone: Ø 78 mm.
- Flessibile rinforzato in metallo.

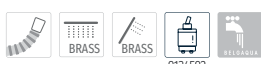

24218004	604,00
24218004AC	936,00
24218004OR	1.399,00
24218004LV	876,00
24218004LM	876,00

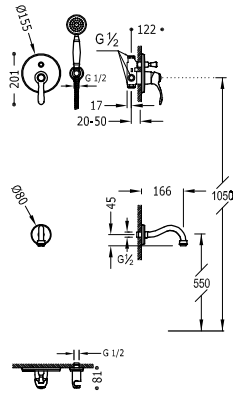

2-way concealed single-handle shower mixer tap kit

- Concealed body included.
- 2-way diverter.
- Fixed wall-mounted spout.
- Wall-mounted support for hand shower with water supply.
- Anti-limescale brass hand shower: Ø 78 mm.
- Reinforced metal hose.

24218005	400,00
24218005AC	620,00
24218005OR	880,00
24218005LV	580,00
24218005LM	580,00

Kit di miscelatore monocomando a incasso 2 getti per doccia

- Corpo a incasso incluso.
- Inverter a 2 getti.
- Canna fissa a muro.
- Supporto per doccino con presa d'acqua a muro.
- Doccino anticalcare in ottone: Ø 78 mm.
- Flessibile rinforzato in metallo.



9134592

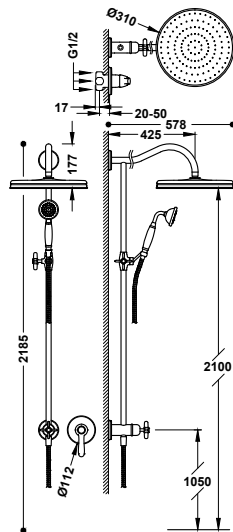

2-way concealed single-handle shower mixer tap kit

- Concealed body included.
- Shower bar set with adjustable brass shower head: Ø 310 mm.
- Inverter integrated into the shower bar.
- Adjustable and sliding support for hand shower.
- Anti-limescale brass hand shower: Ø 78 mm.
- Reinforced metal hose.

24217703	566,00
24217703AC	906,00
24217703LV	821,00
24217703LM	821,00

Kit di miscelatore monocomando a incasso 2 getti per doccia

- Corpo a incasso incluso.
- Set di colonna doccia con soffione orientabile in ottone: Ø 310 mm.
- Inverter incorporato nella colonna della doccia.
- Supporto scorrevole e orientabile per doccino.
- Doccino anticalcare in ottone: Ø 78 mm.
- Flessibile rinforzato in metallo.

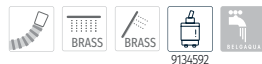

9134592

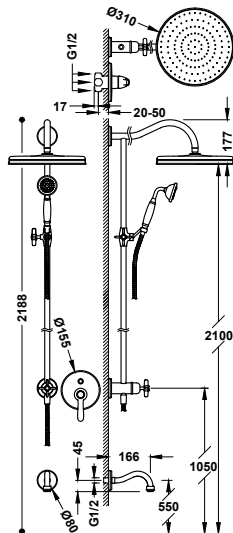

3-way concealed single-handle mixer tap kit for bath and shower

- Concealed body included.
- 2-way diverter.
- Shower bar set with adjustable brass shower head: Ø 310 mm.
- Diverter integrated into the shower bar.
- Adjustable and sliding support for hand shower.
- Anti-limescale brass hand shower: Ø 78 mm.
- Reinforced metal hose.

24218006	678,00
24218006AC	1.051,00
24218006LV	984,00
24218006LM	984,00

Kit di miscelatore monocomando a incasso a 3 getti per vasca e doccia

- Corpo a incasso incluso.
- Inverter a 2 getti.
- Set di colonna doccia con soffione orientabile in ottone: Ø 310 mm.
- Inverter incorporato nella colonna della doccia.
- Supporto scorrevole e orientabile per doccino.
- Doccino anticalcare in ottone: Ø 78 mm.
- Flessibile rinforzato in metallo.

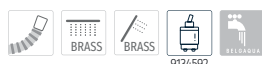

9134592

BATH TAPS / RUBINETTI PER VASCA

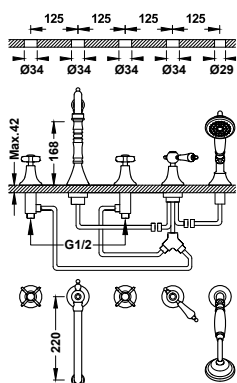

Two-handle bath edge mixer tap

- With handles and diverter.
- Anti-limescale brass hand shower: Ø 78 mm.
- Water flow: 3 bar - 12 l/min.

Miscelatore bicomando bordo vasca

- Con manopole e inverter.
- Doccino anticalcare in ottone: Ø 78 mm.
- Flusso: 3 bar - 12 l/min.

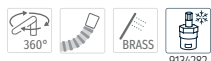

	24214601	610,00
	24214601AC	945,00
	24214601OR	1.342,00
	24214601LV	884,00
	24214601LM	884,00



Click-clack drainage valve with overflow for bath
Valvola di scarico Click-clack per vasca



	13453420	32,00
--	----------	-------

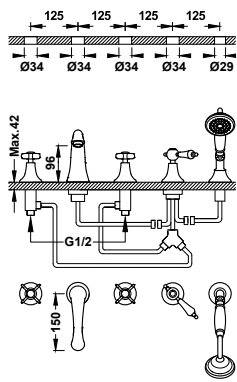

Two-handle bath edge mixer tap

- With handles and diverter.
- Anti-limescale brass hand shower: Ø 78 mm.
- Water flow: 3 bar - 12 l/min.

Miscelatore bicomando bordo vasca

- Con manopole e inverter.
- Doccino anticalcare in ottone: Ø 78 mm.
- Flusso: 3 bar - 12 l/min.

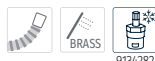

	24214602	583,00
	24214602AC	903,00
	24214602OR	1.282,00
	24214602LV	845,00
	24214602LM	845,00



Click-clack drainage valve with overflow for bath
Valvola di scarico Click-clack per vasca



	13453420	32,00
--	----------	-------

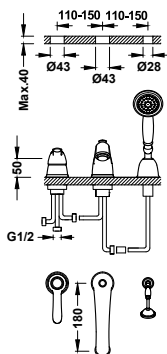

Single-handle bath edge mixer tap

- Inverter integrated into the bath spout.
- Anti-limescale brass hand shower: Ø 78 mm.
- 180 mm bath spout. Water flow: 3 bar - 16 l/min.

Miscelatore monocomando bordo vasca

- Inverter incorporato nella canna della vasca.
- Doccino anticalcare in ottone: Ø 78 mm.
- Canna della vasca di 180 mm. Flusso: 3 bar - 16 l/min.



	24214501	467,00
	24214501AC	724,00
	24214501OR	1.028,00
	24214501LV	678,00
	24214501LM	678,00



Click-clack drainage valve with overflow for bath
Valvola di scarico Click-clack per vasca



	13453420	32,00
--	----------	-------

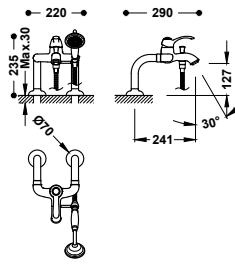

Single-handle bath edge mixer tap with elbow water connectors

With 2 elbow water connectors. Anti-limescale brass hand shower: Ø 78 mm. Fixed support for hand shower. Reinforced metal hose.

Miscelatore monocomando per bordo vasca con prese d'acqua a gomito

Con 2 prese d'acqua a gomito. Doccino anticalcare in ottone: Ø 78 mm. Supporto fisso per doccino. Flessibile rinforzato in metallo.

24219401	459,00
24219401AC	711,00
24219401OR	1.009,00
24219401LV	665,00
24219401LM	665,00

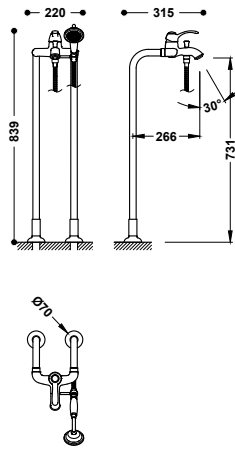

Floorstanding bathtub mixer

2 floor-mounted vertical water supply columns. Anti-limescale brass hand shower: Ø 78 mm. Fixed support for hand shower. Reinforced metal hose.

Miscelatore monocomando da pavimento per vasca e doccia

Con 2 colonne verticali di alimentazione dell'acqua a terra. Doccino anticalcare in ottone: Ø 78 mm. Supporto fisso per doccino. Flessibile rinforzato in metallo.

24219402	648,00
24219402AC	1.004,00
24219402LV	939,00
24219402LM	939,00



THERMOSTATIC WALL TAPS / RUBINETTO TERMOSTATICI A MURO

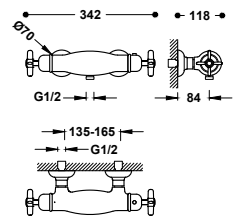

Wall-mounted thermostatic shower mixer tap

Anti-limescale brass hand shower: Ø 78 mm. Adjustable support for hand shower. Reinforced metal hose.

Miscelatore termostatico a muro per doccia

Doccino anticalcare in ottone: Ø 78 mm. Supporto orientabile per doccino. Flessibile rinforzato in metallo.

24216409	488,00
24216409AC	757,00
24216409OR	1.074,00
24216409LV	708,00
24216409LM	708,00

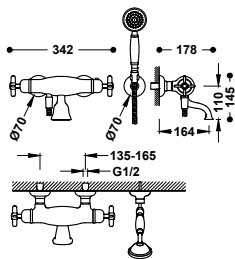

Wall-mounted thermostatic mixer tap for bath and shower

With cascade outlet. Inverter integrated into the flow regulator. Anti-limescale brass hand shower: Ø 78 mm. Adjustable support for hand shower. Reinforced metal hose.

Miscelatore termostatico a muro per vasca e doccia

Con getto a cascata. Inverter incorporato nel regolatore di flusso. Doccino anticalcare in ottone: Ø 78 mm. Supporto orientabile per doccino. Flessibile rinforzato in metallo.

24217409	541,00
24217409AC	838,00
24217409OR	1.190,00
24217409LV	784,00
24217409LM	784,00

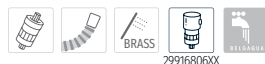

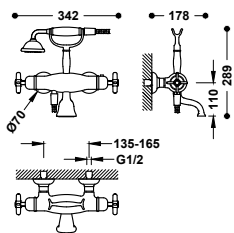

Wall-mounted thermostatic mixer tap for bath and shower

With cascade outlet. Inverter integrated into the flow regulator. Anti-limescale brass hand shower: Ø 78 mm. Fixed support for hand shower. Reinforced metal hose.

Miscelatore termostatico a muro per vasca e doccia

Con getto a cascata. Inverter incorporato nel regolatore di flusso. Doccino anticalcare in ottone: Ø 78 mm. Supporto fisso per doccia. Flessibile rinforzato in metallo.

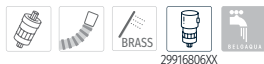

24217609	683,00
24217609AC	1.058,00
24217609OR	1.502,00
24217609LV	990,00
24217609LM	990,00

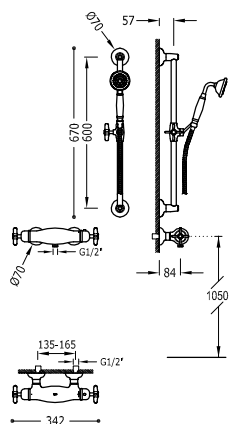

Wall-mounted thermostatic shower mixer tap kit

- Shower bar: length 600 mm.
- Adjustable and sliding support for hand shower.
- Anti-limescale brass hand shower: Ø 78 mm.
- Reinforced metal hose.

Kit di miscelatore termostatico a muro per doccia

- Colonna doccia: lungh. 600 mm.
- Supporto scorrevole e orientabile per doccia.
- Doccino anticalcare in ottone: Ø 78 mm.
- Flessibile rinforzato in metallo.

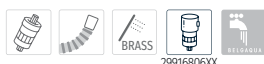

24216402	625,00
24216402AC	969,00
24216402LV	906,00
24216402LM	906,00

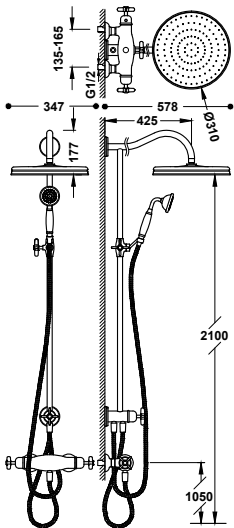

2-way wall-mounted thermostatic shower mixer tap set

- With diverter integrated into the shower bar.
- Adjustable brass shower head: Ø 310 mm.
- Adjustable and sliding support for hand shower.
- Anti-limescale brass hand shower: Ø 78 mm.
- Reinforced metal hose.

Set di miscelatore termostatico a muro 2 getti per doccia

- Con inverter incorporato nella colonna doccia.
- Soffione doccia orientabile in ottone: Ø 310 mm.
- Supporto scorrevole e orientabile per doccia.
- Doccino anticalcare in ottone: Ø 78 mm.
- Flessibile rinforzato in metallo.



24219501	867,00
24219501AC	1.344,00
24219501LV	1.257,00
24219501LM	1.257,00

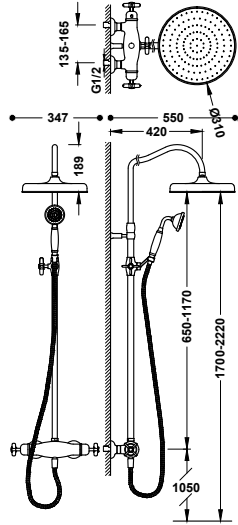

2-way wall-mounted thermostatic shower mixer tap set

- With diverter integrated into the flow regulator.
- Telescopic shower bar.
- Adjustable brass shower head: \varnothing 310 mm.
- Adjustable and sliding support for hand shower.
- Anti-limescale brass hand shower: \varnothing 78 mm.
- Reinforced metal hose.

24219502	1.039,00
24219502AC	1.610,00
24219502LV	1.507,00
24219502LM	1.507,00

Set di miscelatore termostatico a muro 2 getti per doccia

- Con inverter incorporato nel regolatore di flusso.
- Colonna doccia telescopica.
- Soffione doccia orientabile in ottone: \varnothing 310 mm.
- Supporto scorrevole e orientabile per doccia.
- Doccino anticalcare in ottone: \varnothing 78 mm.
- Flessibile rinforzato in metallo.

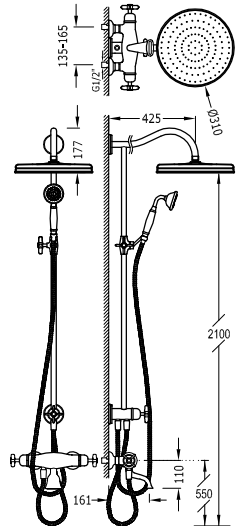
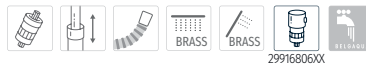

3-way wall-fitted thermostatic mixer tap set for bath and shower

- With diverter integrated into the flow regulator and into the shower bar.
- Cascade outlet.
- Adjustable brass shower head: \varnothing 310 mm.
- Adjustable and sliding support for hand shower.
- Anti-limescale brass hand shower: \varnothing 78 mm.
- Reinforced metal hose.

24219801	964,00
24219801AC	1.494,00
24219801LV	1.398,00
24219801LM	1.398,00

Set di miscelatore termostatico a muro 3 getti per vasca e doccia

- Con inverter incorporato nel regolatore di flusso e nella colonna della doccia.
- Getto a cascata.
- Soffione doccia orientabile in ottone: \varnothing 310 mm.
- Supporto scorrevole e orientabile per doccia.
- Doccino anticalcare in ottone: \varnothing 78 mm.
- Flessibile rinforzato in metallo.

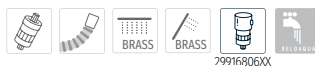

THERMOSTATIC CONCEALED TAPS / RUBINETTI TERMOSTATICI DA INCASSO

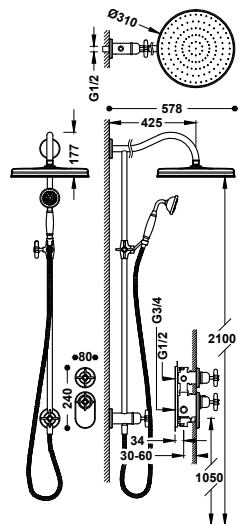

Block System 2-way concealed thermostatic shower mixer tap kit

- Concealed thermostatic body for vertical installation included.
- Flow regulator and 1-way diverter.
- Shower bar set with adjustable brass shower head: \varnothing 310 mm.
- Inverter integrated into the shower bar.
- Adjustable and sliding support for hand shower.
- Anti-limescale brass hand shower: \varnothing 78 mm.
- Reinforced metal hose.

24235203	1.021,00
24235203AC	1.583,00
24235203LV	1.480,00
24235203LM	1.480,00

Kit di miscelatore termostatico a incasso 2 getti Block System per doccia

- Corpo termostatico a incasso con installazione verticale inclusa.
- Regolatore di flusso ed erogatore a 1 getto.
- Set di colonna doccia con soffione orientabile in ottone: \varnothing 310 mm.
- Inverter incorporato nella colonna della doccia.
- Supporto scorrevole e orientabile per doccia.
- Doccino anticalcare in ottone: \varnothing 78 mm.
- Flessibile rinforzato in metallo.

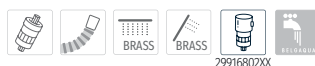

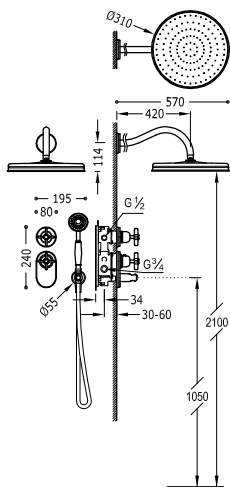

Block System 2-way concealed thermostatic shower mixer tap kit

- Concealed thermostatic body for vertical installation included.
- Flow regulator and 2-way diverter.
- Wall-mounted arm with adjustable brass shower head: Ø 310 mm.
- Wall-mounted support for hand shower with water supply.
- Anti-limescale brass hand shower: Ø 78 mm.
- Reinforced metal hose.

24235202	1.009,00
24235202AC	1.564,00
24235202OR	2.220,00
24235202LV	1.463,00
24235202LM	1.463,00

Kit di miscelatore termostatico a incasso 2 getti Block System per doccia

- Corpo termostatico a incasso con installazione verticale inclusa.
- Regolatore di flusso ed erogatore a 2 getti.
- Braccio a muro con soffione doccia orientabile in ottone: Ø 310 mm.
- Supporto per doccia con presa d'acqua a muro.
- Doccino anticalcare in ottone: Ø 78 mm.
- Flessibile rinforzato in metallo.

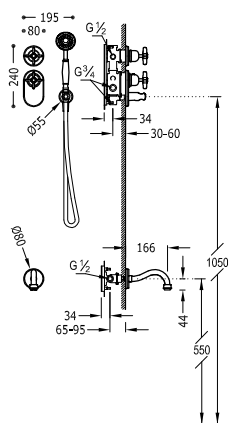
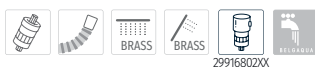

Block System 2-way concealed thermostatic mixer tap kit for bath and shower

- Concealed thermostatic body for vertical installation included.
- Flow regulator and 2-way diverter.
- Fixed wall-mounted spout.
- Wall-mounted support for hand shower with water supply.
- Anti-limescale brass hand shower: Ø 78 mm.
- Reinforced metal hose.

24235201	786,00
24235201AC	1.218,00
24235201OR	1.729,00
24235201LV	1.140,00
24235201LM	1.140,00

Kit di miscelatore termostatico a incasso 2 getti Block System per vasca e doccia

- Corpo termostatico a incasso con installazione verticale inclusa.
- Regolatore di flusso ed erogatore a 2 getti.
- Canna fissa a muro.
- Supporto per doccia con presa d'acqua a muro.
- Doccino anticalcare in ottone: Ø 78 mm.
- Flessibile rinforzato in metallo.

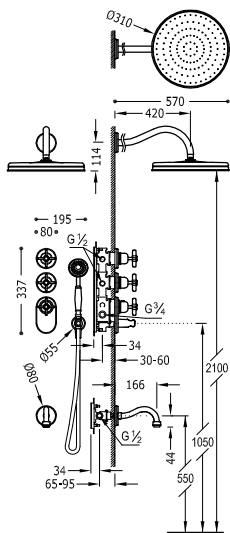
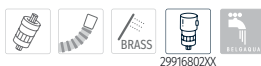

Block System 3-way concealed thermostatic mixer tap kit for bath and shower

- Concealed thermostatic body for vertical installation included.
- Flow regulator and 3-way diverter.
- Wall-mounted arm with adjustable brass shower head: Ø 310 mm.
- Fixed wall-mounted spout.
- Wall-mounted support for hand shower with water supply.
- Anti-limescale brass hand shower: Ø 78 mm.
- Reinforced metal hose.

24235301	1.330,00
24235301AC	2.062,00
24235301OR	2.926,00
24235301LV	1.929,00
24235301LM	1.929,00

Kit di miscelatore termostatico a incasso 3 getti Block System per vasca e doccia

- Corpo termostatico a incasso con installazione verticale inclusa.
- Regolatore di flusso ed erogatore a 3 getti.
- Braccio a muro con soffione doccia orientabile in ottone: Ø 310 mm.
- Canna fissa a muro.
- Supporto per doccia con presa d'acqua a muro.
- Doccino anticalcare in ottone: Ø 78 mm.
- Flessibile rinforzato in metallo.

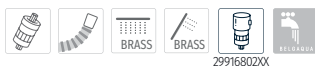

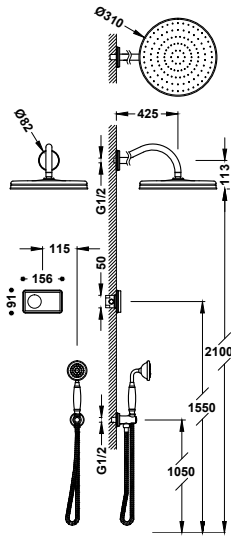

Shower technology 2-way concealed electronic thermostatic shower tap kit

- Electronic control included with Schlüter anti-moisture seals.
- 2-way electronic thermostatic control box included.
- Wall-mounted arm with adjustable brass shower head: Ø 310 mm.
- Wall-mounted support for hand shower with water supply.
- Anti-limescale brass hand shower: Ø 78 mm.
- Reinforced metal hose.

09226201	1.176,00
09226201AC	1.640,00
09226201OR	2.158,00
09226201LV	1.624,00
09226201LM	1.624,00

Kit di miscelatore termostatico elettronico a incasso 2 getti Shower technology per doccia

- Controllo elettronico incluso con guarnizioni antiumidità Schlüter.
- Centralina elettronica termostatica inclusa a 2 getti.
- Braccio a muro con soffione doccia orientabile in ottone: Ø 310 mm.
- Supporto per doccia con presa d'acqua a muro.
- Doccino anticalcare in ottone: Ø 78 mm.
- Flessibile rinforzato in metallo.

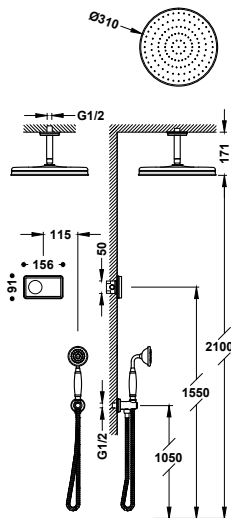
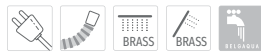

Shower technology 2-way concealed electronic thermostatic shower tap kit

- Electronic control included with Schlüter anti-moisture seals.
- 2-way electronic thermostatic control box included.
- Ceiling-mounted arm with brass adjustable shower head: Ø 310 mm.
- Wall-mounted support for hand shower with water supply.
- Anti-limescale brass hand shower: Ø 78 mm.
- Reinforced metal hose.

09226202	1.213,00
09226202AC	1.596,00
09226202OR	2.095,00
09226202LV	1.589,00
09226202LM	1.589,00

Kit di miscelatore termostatico elettronico a incasso 2 getti Shower technology per doccia

- Controllo elettronico incluso con guarnizioni antiumidità Schlüter.
- Centralina elettronica termostatica inclusa a 2 getti.
- Braccio a soffitto con soffione doccia orientabile in ottone: Ø 310 mm.
- Supporto per doccia con presa d'acqua a muro.
- Doccino anticalcare in ottone: Ø 78 mm.
- Flessibile rinforzato in metallo.

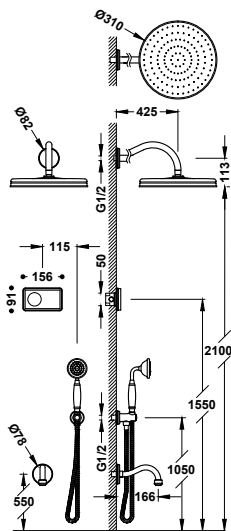

Shower technology 3-way concealed electronic thermostatic tap kit for bath and shower

- Electronic control included with Schlüter anti-moisture seals.
- 3-way electronic thermostatic control box included.
- Wall-mounted arm with adjustable brass shower head: Ø 310 mm.
- Fixed wall-mounted spout.
- Wall-mounted support for hand shower with water supply.
- Anti-limescale brass hand shower: Ø 78 mm.
- Reinforced metal hose.

09226301	1.383,00
09226301AC	1.834,00
09226301OR	2.422,00
09226301LV	1.805,00
09226301LM	1.805,00

Kit di miscelatore termostatico elettronico a incasso 3 getti Shower technology per vasca e doccia

- Controllo elettronico incluso con guarnizioni antiumidità Schlüter.
- Centralina elettronica termostatica inclusa a 3 getti.
- Braccio a muro con soffione doccia orientabile in ottone: Ø 310 mm.
- Canna fissa a muro.
- Supporto per doccia con presa d'acqua a muro.
- Doccino anticalcare in ottone: Ø 78 mm.
- Flessibile rinforzato in metallo.



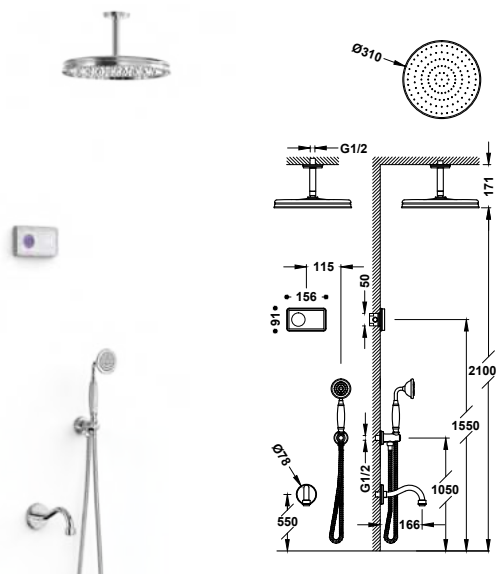

Shower technology 3-way concealed electronic thermostatic tap kit for bath and shower

- Electronic control included with Schlüter anti-moisture seals.
- 3-way electronic thermostatic control box included.
- Ceiling-mounted arm with brass adjustable shower head: Ø 310 mm.
- Fixed wall-mounted spout.
- Wall-mounted support for hand shower with water supply.
- Anti-limescale brass hand shower: Ø 78 mm.
- Reinforced metal hose.

Kit di miscelatore termostatico elettronico a incasso 3 getti Shower technology per vasca e doccia

- Controllo elettronico incluso con guarnizioni antimidità Schlüter.
- Centralina elettronica termostatica inclusa a 3 getti.
- Braccio a soffitto con soffione doccia orientabile in ottone: Ø 310 mm.
- Canna fissa a muro.
- Supporto per doccia con presa d'acqua a muro.
- Doccino anticalcare in ottone: Ø 78 mm.
- Flessibile rinforzato in metallo.

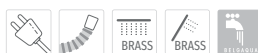

09226302	1.355,00
09226302AC	1.791,00
09226302OR	2.340,00
09226302LV	1.770,00
09226302LM	1.770,00

TAPS FOR VARIOUS USES / RUBINETTI PER USI DIVERSI

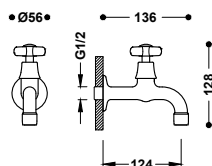

Concealed tap with 1 water outlet for office or utility room

With G1/2 threaded connection

Miscelatore monoacqua per o zona pranzo o lavatoio

Con attacco filettato da G1/2



24252001	103,00
24252001AC	159,00
24252001OR	226,00
24252001LV	149,00
24252001LM	149,00

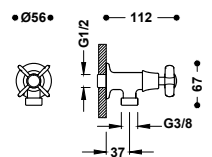

Concealed tap with 1 water outlet for washing machine

With G1/2 threaded connection

Miscelatore monoacqua per lavatrice

Con attacco filettato da G1/2



24250001	88,00
24250001AC	136,00
24250001OR	193,00
24250001LV	127,00
24250001LM	127,00

SHUT-OFF VALVES / VALVOLE DI INTERCETTAZIONE

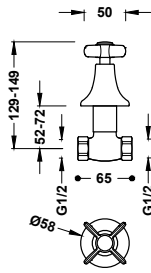

Concealed shut-off valve

With G1/2 threaded connection. Ceramic index (cold).

Valvola di intercettazione a incasso

Con attacco filettato da G1/2. Indicatore in ceramica (freddo).

24215501	93,00
24215501AC	145,00
24215501OR	206,00
24215501LV	136,00
24215501LM	136,00

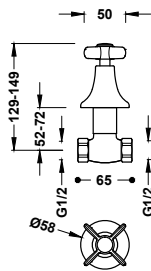

Concealed shut-off valve

With G1/2 threaded connection. Ceramic index (hot).

Valvola di intercettazione a incasso

Con attacco filettato da G1/2. Indicatore in ceramica (caldo).

24215502	93,00
24215502AC	145,00
24215502OR	206,00
24215502LV	136,00
24215502LM	136,00

SHOWER COMPLEMENTS / COMPLEMENTI PER DOCCIA

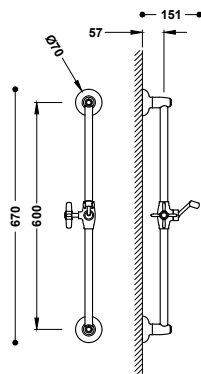

Sliding shower bar

Shower bar: length 600 mm and \varnothing 20.6 mm. Adjustable and sliding support for hand shower.

Colonna scorrevole per doccia

Colonna doccia: lung. 600 mm e \varnothing 20,6 mm. Supporto scorrevole e orientabile per doccia.

24273201	216,00
24273201AC	335,00
24273201LV	313,00
24273201LM	313,00

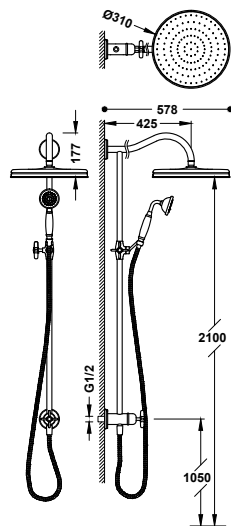

Shower bar set without mixer tap with wall water supply and shower head

- With diverter integrated into the shower bar.
- Adjustable brass shower head: \varnothing 310 mm.
- Adjustable and sliding support for hand shower.
- Anti-limescale brass hand shower: \varnothing 78 mm.
- Reinforced metal hose.

Set di colonna doccia senza miscelatore con presa d'acqua a muro e soffione

- Con inverter incorporato nella colonna doccia.
- Soffione doccia orientabile in ottone: \varnothing 310 mm.
- Supporto scorrevole e orientabile per doccia.
- Doccino anticalcare in ottone: \varnothing 78 mm.
- Flessibile rinforzato in metallo.

24247602	481,00
24247602AC	745,00
24247602LV	697,00
24247602LM	697,00



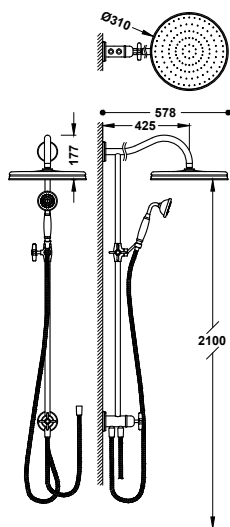

Shower bar set adjustable to any tap type

- With diverter integrated into the shower bar.
- Adjustable brass shower head: Ø 310 mm.
- Adjustable and sliding support for hand shower.
- Anti-limescale brass hand shower: Ø 78 mm.
- Reinforced metal hose.

Set colonna doccia adattabile a qualsiasi miscelatore

- Con inverter incorporato nella colonna doccia.
- Soffione doccia orientabile in ottone: Ø 310 mm.
- Supporto scorrevole e orientabile per doccia.
- Doccino anticalcare in ottone: Ø 78 mm.
- Flessibile rinforzato in metallo.

■ 24247601	494,00
■ 24247601AC	765,00
■ 24247601LV	716,00
■ 24247601LM	716,00

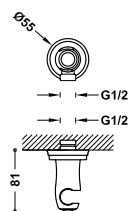

Fixed support with water supply for hand shower and hose

With wall water supply.

Supporto fisso con presa d'acqua per doccia e flessibile

Con presa d'acqua a muro.

■ 24218201	71,00
■ 24218201AC	111,00
■ 24218201OR	157,00
■ 24218201LV	104,00
■ 24218201LM	104,00

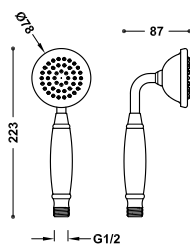

Hand shower Clasic

Ceramic handle. Dimensions: Ø 78 mm. Material: Brass. Anti-limescale nozzles.

Doccino Clasic

Manico in ceramica. Dimensioni: Ø 78 mm. Materiale: Ottone. Fori anticalcare.

■ 29963109	58,00
■ 29963109AC	90,00
■ 29963109OR	145,00
■ 29963109LV	84,00
■ 29963109LM	84,00

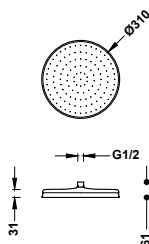

Shower head Clasic

Dimensions: Ø 310 mm. Adjustable shower head. Material: Brass. Anti-limescale nozzles.

Soffione doccia Clasic

Dimensioni: Ø 310 mm. Supporto orientabile. Materiale: Ottone. Fori anticalcare.

■ 29933703	268,00
■ 29933703AC	415,00
■ 29933703OR	590,00
■ 29933703LV	389,00
■ 29933703LM	389,00



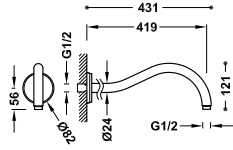

Wall-mounted arm Clasic

For shower head. Length: 419 mm.

Braccio a muro Clasic

Per soffione doccia. Lunghezza: 419 mm.

	29933701	84,00
	29933701AC	130,00
	29933701OR	185,00
	29933701LV	122,00
	29933701LM	122,00

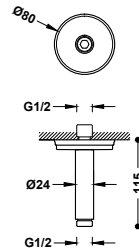

Wall-mounted arm Clasic

For shower head. Length: 115 mm.

Braccio a muro Clasic

Per soffione doccia. Lunghezza: 115 mm.

	29933702	60,00
	29933702AC	93,00
	29933702OR	132,00
	29933702LV	87,00
	29933702LM	87,00

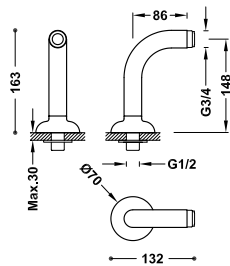

Elbow water connectors for installation on bath edge for bath tap

2 units with silencer.

Prese d'acqua a gomito bordo vasca per miscelatore della vasca

2 unità con silenziatore.

	24287101	154,00
	24287101AC	239,00
	24287101OR	339,00
	24287101LV	223,00
	24287101LM	223,00

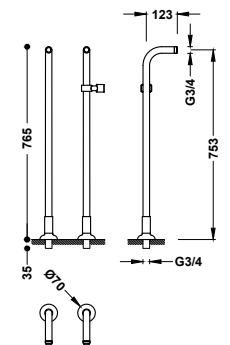

Elbow water connectors for floor installation for bath tap

2 floor-mounted vertical water supply columns.

Prese d'acqua a gomito da terra per miscelatore della vasca

2 colonne verticali di alimentazione dell'acqua a terra.

	24219403	350,00
	24219403AC	543,00
	24219403OM	770,00
	24219403LV	508,00
	24219403LM	508,00



SLIM

Stylish and slim lines that offer you unrivalled exclusivity. The Slim range features slender parts and elegant finishes, highlighting its length and underlining its unique, personal and contemporary style.

Linee stilizzate e sottili per un'esclusività impareggiabile. La finezza dei pezzi della serie Slim e l'eleganza delle loro finiture ne sottolineano l'estensione ed enfatizzano uno stile unico, personale e contemporaneo.

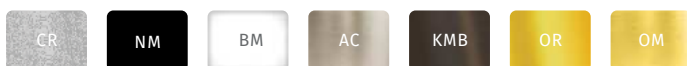





WASHBASIN TAPS / RUBINETTI PER LAVABO

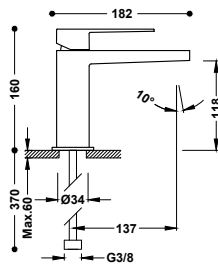

Single-handle washbasin mixer tap

G3/8 flexible hoses.

Miscelatore monocomando per lavabo

Flessibili di alimentazione G3/8.



	20210301	193,00
	20210301D	216,00
	20210301NM	299,00
	20210301BM	299,00
	20210301AC	299,00
	20210301KMB	299,00 N
	20210301OR	425,00
	20210301OM	425,00

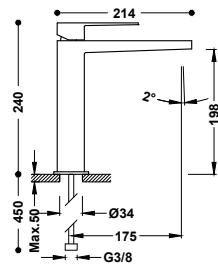

High single-handle washbasin mixer tap

G3/8 flexible hoses.

Miscelatore monocomando alto per lavabo

Flessibili di alimentazione G3/8.



	20210303	362,00
	20210303NM	561,00
	20210303BM	561,00
	20210303AC	561,00
	20210303KMB	561,00 N
	20210303OR	797,00
	20210303OM	797,00

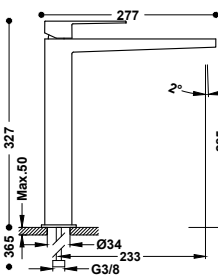

XXL single-handle washbasin mixer tap

G3/8 flexible hoses.

Miscelatore monocomando XXL per lavabo

Flessibili di alimentazione G3/8.



	20210305	399,00
	20210305NM	618,00
	20210305BM	618,00
	20210305AC	618,00
	20210305KMB	618,00 N
	20210305OR	878,00
	20210305OM	878,00

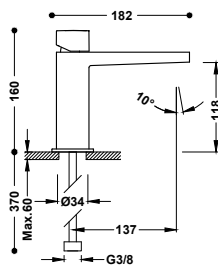

Single-handle washbasin mixer tap

G3/8 flexible hoses.

Miscelatore monocomando per lavabo

Flessibili di alimentazione G3/8.



	20210302	193,00
	20210302D	216,00

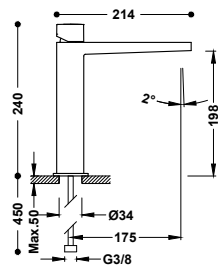

High single-handle washbasin mixer tap

G3/8 flexible hoses.

Miscelatore monocomando alto per lavabo

Flessibili di alimentazione G3/8.



	20210304	362,00
--	----------	--------

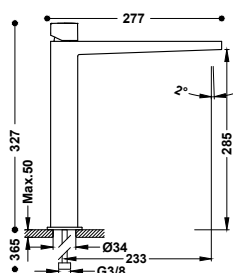

XXL single-handle washbasin mixer tap

G3/8 flexible hoses.

Miscelatore monocomando XXL per lavabo

Flessibili di alimentazione G3/8.



20210306 399,00

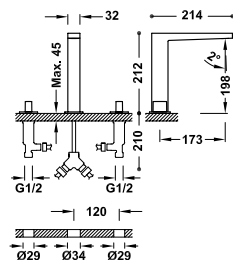

Deck-mounted 3-hole basin mixer

Can be freely installed. With handles.

Miscelatore bicomando bordo lavabo

Libera installazione. Con manopole.



20210501 389,00
 20210501NM 602,00
 20210501BM 602,00
 20210501AC 602,00
 20210501OR 855,00
 20210501OM 855,00

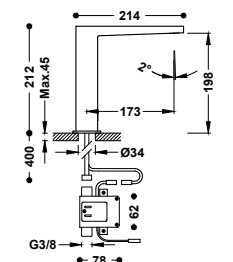

Electronic washbasin tap with 1 water outlet

Operated by infrared sensor.

Rubinetto elettronico monoacqua per lavabo

Azionato mediante sensore a infrarossi.



20261310 357,00
 20261310NM 553,00
 20261310BM 553,00
 20261310AC 553,00
 20261310OR 785,00
 20261310OM 785,00

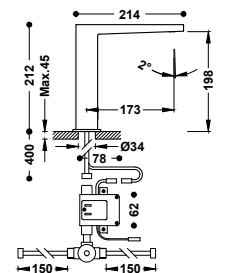

Electronic washbasin tap with pre-mixing system

Operated by infrared sensor. Includes a 2-outlet mixer valve with flexible hoses.

Rubinetto elettronico con sistema di premiscelazione per lavabo

Azionato mediante sensore a infrarossi. È inclusa una valvola miscelatrice a 2 getti con tubi flessibili.



20261320 399,00
 20261320NM 618,00
 20261320BM 618,00
 20261320AC 618,00
 20261320OR 878,00
 20261320OM 878,00

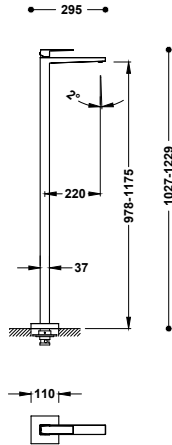

Single-handle washbasin mixer tap with floor water supply

Concealed box not included (Ref. 26285350). 1 floor-mounted vertical water supply column.

Miscelatore monocomando con presa a terra per lavabo

Scatola incassata (Ref. 26285350) non inclusa. 1 colonna verticale di alimentazione dell'acqua a terra.

20285301	660,00
20285301NM	1.023,00
20285301BM	1.023,00
20285301AC	1.023,00
20285301KM	1.023,00
20285301KMB	1.023,00
20285301OR	1.452,00
20285301OM	1.452,00
20285301OP	1.452,00
20285301OPM	1.452,00



Concealing base for floor installation of single-handle mixer taps

26285350	189,00
404	

Base a incasso per montaggio di miscelatori monocomando a pavimento

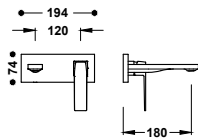

Visible part for recessed sink body

Visible part only. Includes concealing plate, handle and 180 mm spout. Recessed body not included.

Elemento a vista per il corpo a incasso da lavello

Solo parte a vista. Include piastra decorativa, comando e beccuccio da 180 mm. Corpo a incasso non incluso.

20230031	205,00
20230031NM	318,00
20230031BM	318,00
20230031AC	318,00
20230031KMB	318,00
20230031OR	451,00
20230031OM	451,00



Recessed body for sink tap

20830002	85,00
----------	-------

Corpo a incasso per rubinetto da lavello

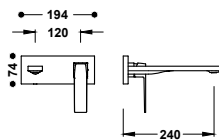

Visible part for recessed sink body

Visible part only. Includes concealing plate, handle and 240 mm spout. Recessed body not included.

Elemento a vista per il corpo a incasso da lavello

Solo parte a vista. Include piastra decorativa, comando e beccuccio da 240 mm. Corpo a incasso non incluso.

20230032	215,00
20230032NM	333,00
20230032BM	333,00
20230032AC	333,00
20230032KMB	333,00
20230032OR	473,00
20230032OM	473,00



Recessed body for sink tap

20830002	85,00
----------	-------

Corpo a incasso per rubinetto da lavello

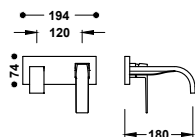

Visible part for recessed sink body

Visible part only. Includes concealing plate, handle and 180 mm spout. Recessed body not included.

Elemento a vista per il corpo a incasso da lavello

Solo parte a vista. Include piastra decorativa, comando e beccuccio da 180 mm. Corpo a incasso non incluso.

	20230033	220,00
	20230033NM	341,00
	20230033BM	341,00
	20230033AC	341,00
	20230033OR	484,00
	20230033OM	484,00



Recessed body for sink tap

20830002

85,00

Corpo a incasso per rubinetto da lavello

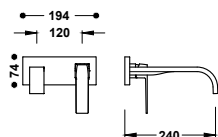

Visible part for recessed sink body

Visible part only. Includes concealing plate, handle and 240 mm spout. Recessed body not included.

Elemento a vista per il corpo a incasso da lavello

Solo parte a vista. Include piastra decorativa, comando e beccuccio da 240 mm. Corpo a incasso non incluso.

	20230034	240,00
	20230034NM	372,00
	20230034BM	372,00
	20230034AC	372,00
	20230034OR	528,00
	20230034OM	528,00



Recessed body for sink tap

20830002

85,00

Corpo a incasso per rubinetto da lavello

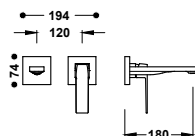







Visible part for recessed sink body

Visible part only. Includes concealing plate, handle and 180 mm spout. Recessed body not included.

Elemento a vista per il corpo a incasso da lavello

Solo parte a vista. Include piastra decorativa, comando e beccuccio da 180 mm. Corpo a incasso non incluso.

	20230021	170,00
	20230021NM	264,00
	20230021BM	264,00
	20230021AC	264,00
	20230021KMB	264,00
	20230021OR	374,00
	20230021OM	374,00



Recessed body for sink tap

20830002

85,00

Corpo a incasso per rubinetto da lavello

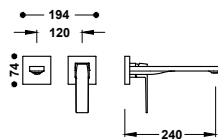

Visible part for recessed sink body

Visible part only. Includes concealing plate, handle and 240 mm spout. Recessed body not included.

Elemento a vista per il corpo a incasso da lavello

Solo parte a vista. Include piastra decorativa, comando e beccuccio da 240 mm. Corpo a incasso non incluso.

	20230022	180,00
	20230022NM	279,00
	20230022BM	279,00
	20230022AC	279,00
	20230022KMB	279,00
	20230022OR	396,00
	20230022OM	396,00



Recessed body for sink tap

20830002

85,00

Corpo a incasso per rubinetto da lavello

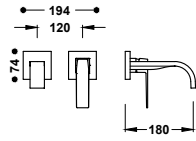

Visible part for recessed sink body

Visible part only. Includes concealing plate, handle and 180 mm spout. Recessed body not included.

Elemento a vista per il corpo a incasso da lavello

Solo parte a vista. Include piastra decorativa, comando e beccuccio da 180 mm. Corpo a incasso non incluso.

	20230023	185,00
	20230023NM	287,00
	20230023BM	287,00
	20230023AC	287,00
	20230023OR	287,00
	20230023OM	287,00



Recessed body for sink tap

20830002 85,00

Corpo a incasso per rubinetto da lavello

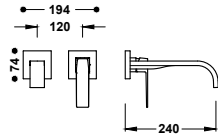

Visible part for recessed sink body

Visible part only. Includes concealing plate, handle and 240 mm spout. Recessed body not included.

Elemento a vista per il corpo a incasso da lavello

Solo parte a vista. Include piastra decorativa, comando e beccuccio da 240 mm. Corpo a incasso non incluso.

	20230024	195,00
	20230024NM	302,00
	20230024BM	302,00
	20230024AC	302,00
	20230024OR	429,00
	20230024OM	429,00



Recessed body for sink tap

20830002 85,00

Corpo a incasso per rubinetto da lavello

BIDET TAPS / RUBINETTI PER BIDET

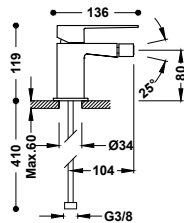

Single-handle bidet mixer tap

Adjustable shower head. G3/8 flexible hoses.

Miscelatore monocomando per bidet

Supporto orientabile. Flessibili di alimentazione G3/8.

	20212001	196,00
	20212001D	219,00
	20212001NM	304,00
	20212001BM	304,00
	20212001AC	304,00
	20212001KMB	304,00
	20212001OR	432,00
	20212001OM	432,00

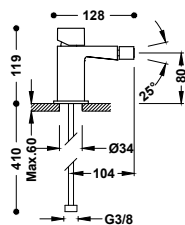

Single-handle bidet mixer tap

Adjustable shower head. G3/8 flexible hoses.

Miscelatore monocomando per bidet

Supporto orientabile. Flessibili di alimentazione G3/8.

	20212002	196,00
	20212002D	219,00



WALL TAPS / RUBINETTI A MURO

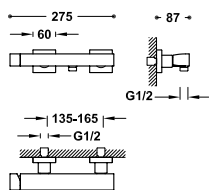

Wall-mounted single-handle shower mixer tap

Anti-limescale brass hand shower. Adjustable support for hand shower. Satin hose.

Miscelatore monocomando a muro per doccia

Doccino anticalcare in ottone. Supporto orientabile per doccino. Flessibile satinato.



20216701	344,00
20216701NM	534,00
20216701BM	534,00
20216701AC	534,00
20216701KMB	534,00
20216701OR	758,00
20216701OM	758,00

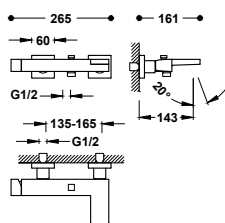

Wall-mounted single-handle mixer tap for bath and shower

Anti-limescale brass hand shower. Adjustable support for hand shower. Satin hose.

Miscelatore monocomando a muro per vasca e doccia

Doccino anticalcare in ottone. Supporto orientabile per doccino. Flessibile satinato.



20217001	365,00
20217001NM	566,00
20217001BM	566,00
20217001AC	566,00
20217001KMB	566,00
20217001OR	804,00
20217001OM	804,00

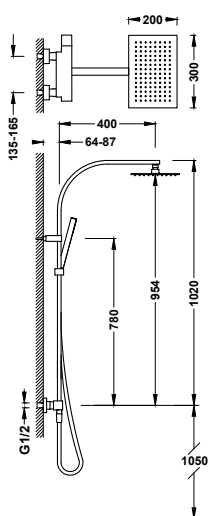

2-way wall-fitted single-handle shower mixer tap

- Stainless steel adjustable shower head: 300x200 mm.
- Adjustable and sliding support for hand shower.
- Anti-limescale brass hand shower.
- Satin hose.

Set miscelatore monocomando a muro 2 getti per doccia

- Soffione doccia orientabile in acciaio inossidabile: 300x200 mm.
- Supporto scorrevole e orientabile per doccino.
- Doccino anticalcare in ottone.
- Flessibile satinato.

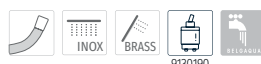

20219101	715,00
20219101NM	1.108,00
20219101BM	1.108,00
20219101AC	1.108,00
20219101KMB	1.108,00

CONCEALED TAPS/ RUBINETTI DA INCASSO

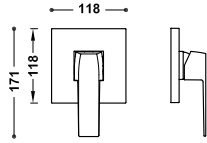

Visible part for concealed 1-way Rapid-box

Only visible part. Includes trim plate, control, bush and concealed attachment screw. Complete with concealed Rapid-box ref: 20827810.

Pezzo vista per cassa da incasso a 1 via Rapid-box

Solo parte vista. Include piastra decorativa, comando, boccola e vite di fissaggio occulta. Completare con scatola da incasso Rapid-box rif: 20827810.

	20227810	89,00
	20227810NM	138,00
	20227810BM	138,00
	20227810AC	138,00
	20227810KMB	138,00 N
	20227810OR	196,00
	20227810OM	196,00



Concealed 1-way Rapid-box with single-handle mixer tap for shower

20827810 80,00

Scatola da incasso a 1 via Rapid-box con miscelatore monocomando per doccia

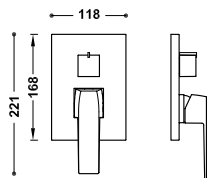

Visible part for concealed 2-way Rapid-box

Only visible part. Includes trim plate, control, distribution handle and concealed attachment screw. Complete with concealed Rapid-box ref: 20828110.

Pezzo vista per cassa da incasso a 2 vie Rapid-box

Solo parte vista. Include piastra decorativa, comando, volante distributore e vite di fissaggio occulta. Completare con scatola da incasso Rapid-box rif: 20828110.

	20228110	116,00
	20228110NM	179,00
	20228110BM	179,00
	20228110AC	179,00
	20228110KMB	179,00 N
	20228110OR	254,00
	20228110OM	254,00



Concealed 2-way Rapid-box with single-handle mixer tap for shower and bath

20828110 90,00

Scatola da incasso a 2 vie Rapid-box con miscelatore monocomando per doccia e vasca da bagno

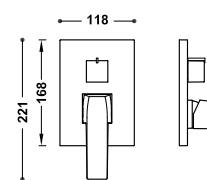

Visible part for concealed 3-way Rapid-box

Only visible part. Includes trim plate, control, distribution handle and concealed attachment screw. Complete with concealed Rapid-box ref: 20827310.

Pezzo vista per cassa da incasso a 3 vie Rapid-box

Solo parte vista. Include piastra decorativa, comando, volante distributore e vite di fissaggio occulta. Completare con scatola da incasso Rapid-box rif: 20827310.

	20227310	125,00
	20227310NM	194,00
	20227310BM	194,00
	20227310AC	194,00
	20227310OR	275,00
	20227310OM	275,00



Concealed 3-way Rapid-box with single-handle mixer tap for shower and bath

20827310 95,00

Scatola da incasso a 3 vie Rapid-box con miscelatore monocomando per doccia e vasca da bagno

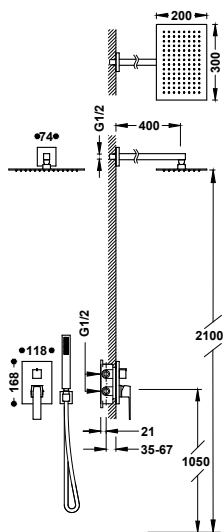

Rapid-box 2-way concealed single-handle shower mixer tap kit

- Concealed body included.
- 2-way ceramic distributor.
- Wall-mounted arm with adjustable stainless steel shower head: 300x200 mm.
- Wall-mounted support for hand shower with water supply.
- Anti-limescale brass hand shower.
- Satin hose.

Kit di miscelatore monocomando a incasso 2 getti Rapid-box per doccia

- Corpo a incasso incluso.
- Erogatore in ceramica a 2 getti.
- Braccio a muro con soffione doccia orientabile in acciaio inossidabile: 300x200 mm.
- Supporto per doccia con presa d'acqua a muro.
- Doccino anticalcare in ottone.
- Flessibile satinato.

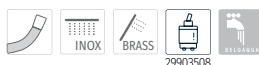

20228004	595,00
20228004NM	868,00
20228004BM	868,00
20228004AC	868,00
20228004KMB	868,00
20228004OR	1.195,00
20228004OM	1.195,00

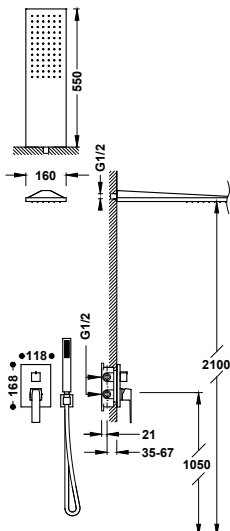

Rapid-box 2-way concealed single-handle shower mixer tap kit

- Concealed body included.
- 2-way ceramic distributor.
- Stainless steel wall-mounted shower head: 160x550 mm.
- Wall-mounted support for hand shower with water supply.
- Anti-limescale brass hand shower.
- Satin hose.

Kit di miscelatore monocomando a incasso 2 getti Rapid-box per doccia

- Corpo a incasso incluso.
- Erogatore in ceramica a 2 getti.
- Soffione doccia a muro in acciaio inossidabile: 160x550 mm.
- Supporto per doccia con presa d'acqua a muro.
- Doccino anticalcare in ottone.
- Flessibile satinato.

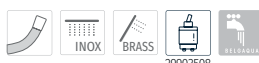

20228005	750,00
20228005NM	1.108,00
20228005BM	1.108,00
20228005AC	1.108,00
20228005OR	1.537,00
20228005OM	1.537,00

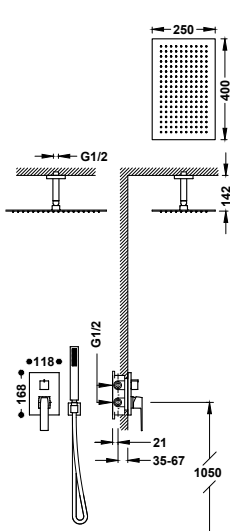

Rapid-box 2-way concealed single-handle shower mixer tap kit

- Concealed body included.
- 2-way ceramic distributor.
- Ceiling-mounted arm with adjustable stainless steel shower head: 400x250 mm.
- Wall-mounted support for hand shower with water supply.
- Anti-limescale brass hand shower.
- Satin hose.

Kit di miscelatore monocomando a incasso 2 getti Rapid-box per doccia

- Corpo a incasso incluso.
- Erogatore in ceramica a 2 getti.
- Braccio a soffitto con soffione doccia orientabile in acciaio inossidabile: 400x250 mm.
- Supporto per doccia con presa d'acqua a muro.
- Doccino anticalcare in ottone.
- Flessibile satinato.

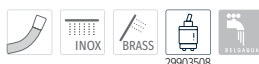

20228003	621,00
20228003NM	916,00
20228003BM	916,00
20228003AC	916,00
20228003OR	1.263,00
20228003OM	1.263,00

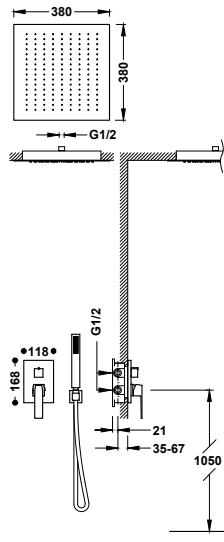

Rapid-box 2-way concealed single-handle shower mixer tap kit

- Concealed body included.
- 2-way ceramic distributor.
- Concealed stainless steel ceiling-mounted shower head: 380x380 mm.
- Wall-mounted support for hand shower with water supply.
- Anti-limescale brass hand shower.
- Satin hose.

20228006	1.100,00
20228006NM	1.657,00
20228006BM	1.657,00
20228006AC	1.657,00
20228006OR	2.316,00
20228006OM	2.316,00

Kit di miscelatore monocomando a incasso 2 getti Rapid-box per doccia

- Corpo a incasso incluso.
- Erogatore in ceramica a 2 getti.
- Soffione doccia soffitto a incasso in acciaio inossidabile: 380x380 mm.
- Supporto per doccia con presa d'acqua a muro.
- Doccino anticalcare in ottone.
- Flessibile satinato.

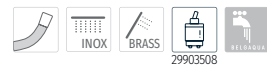

Rapid-box 2-way concealed single-handle mixer tap kit for bath and shower

- Concealed body included.
- 2-way ceramic distributor.
- Fixed wall-mounted spout.
- Wall-mounted support for hand shower with water supply.
- Anti-limescale brass hand shower.
- Satin hose.

20228007	462,00
20228007NM	651,00
20228007BM	651,00
20228007AC	651,00
20228007OR	907,00
20228007OM	907,00

Kit di miscelatore monocomando a incasso a 2 getti Rapid-box per vasca e doccia

- Corpo a incasso incluso.
- Erogatore in ceramica a 2 getti.
- Canna fissa a muro.
- Supporto per doccia con presa d'acqua a muro.
- Doccino anticalcare in ottone.
- Flessibile satinato.

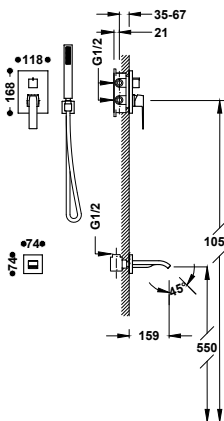
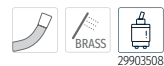

Rapid-box 3-way concealed single-handle shower mixer tap kit

- Concealed body included.
- 3-way ceramic distributor.
- Stainless steel wall-mounted shower head with 2 stream types (rain/cascade). 280x550 mm. IMPORTANT: Install a >50 l/min drain.
- Wall-mounted support for hand shower with water supply.
- Anti-limescale brass hand shower.
- Satin hose.

20227301	1.076,00
20227301NM	1.618,00
20227301BM	1.618,00
20227301AC	1.618,00
20227301KMB	1.618,00
20227301OR	2.258,00
20227301OM	2.258,00

Kit di miscelatore monocomando a incasso 3 getti Rapid-box per doccia

- Corpo a incasso incluso.
- Erogatore in ceramica a 3 getti.
- Soffione doccia a muro in acciaio inossidabile con 2 tipi di getto (pioggia/cascata). 280x550 mm. IMPORTANTE: Montare uno scarico da >50 l/min.
- Supporto per doccia con presa d'acqua a muro.
- Doccino anticalcare in ottone.
- Flessibile satinato.

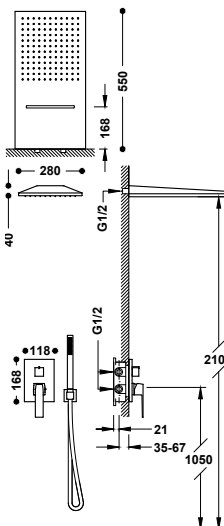

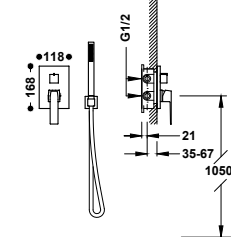
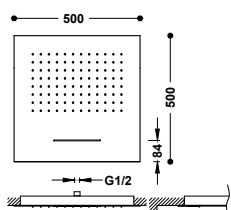

Rapid-box 3-way concealed single-handle shower mixer tap kit

- Concealed body included.
- 3-way ceramic distributor.
- Stainless steel concealed ceiling-mounted shower head with 2 stream types (rain/cascade). 500x500 mm. IMPORTANT: Install a >50 l/min drain.
- Wall-mounted support for hand shower with water supply.
- Anti-limescale brass hand shower.
- Satin hose.

	20227302	1.445,00
	20227302NM	2.189,00
	20227302BM	2.189,00
	20227302AC	2.189,00
	20227302KMB	2.189,00
	20227302OR	3.069,00
	20227302OM	3.069,00

Kit di miscelatore monocomando a incasso 3 getti Rapid-box per doccia

- Corpo a incasso incluso.
- Erogatore in ceramica a 3 getti.
- Soffione doccia a incasso da soffitto in acciaio inossidabile con 2 tipi di getto (pioggia/cascata). 500x500 mm. IMPORTANTE: Montare uno scarico da >50 l/min.
- Supporto per doccia con presa d'acqua a muro.
- Doccino anticalcare in ottone.
- Flessibile satinato.

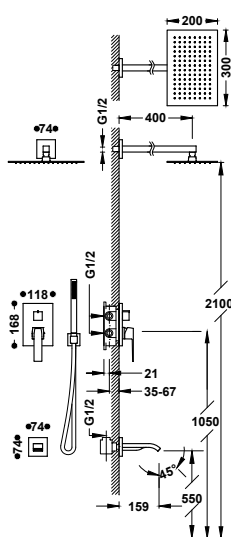

Rapid-box 3-way concealed single-handle shower mixer tap kit

- Concealed body included.
- 3-way ceramic distributor.
- Wall-mounted arm with adjustable stainless steel shower head: 300x200 mm.
- Fixed wall-mounted spout.
- Wall-mounted support for hand shower with water supply.
- Anti-limescale brass hand shower.
- Satin hose.

	20227303	786,00
	20227303NM	1.203,00
	20227303BM	1.203,00
	20227303AC	1.203,00
	20227303OR	1.618,00
	20227303OM	1.618,00

Kit di miscelatore monocomando a incasso 3 getti Rapid-box per doccia

- Corpo a incasso incluso.
- Erogatore in ceramica a 3 getti.
- Braccio a muro con soffione doccia orientabile in acciaio inossidabile: 300x200 mm.
- Canna fissa a muro.
- Supporto per doccia con presa d'acqua a muro.
- Doccino anticalcare in ottone.
- Flessibile satinato.



BATH TAPS / RUBINETTI PER VASCA

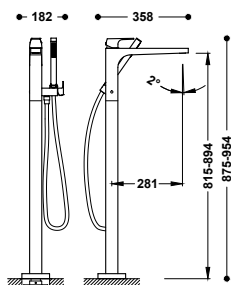

Floorstanding bathtub mixer

- Concealed box not included (ref. 26285350). 1 floor-mounted vertical water supply column. Support for hand shower with independent flow regulation and closure. Anti-limescale brass hand shower. Satin hose.

Miscelatore monocomando da pavimento per vasca e doccia

- Scatola incassata (ref. 26285350) non inclusa. 1 colonna verticale di alimentazione dell'acqua a terra. Supporto per doccia con chiusura e regolazione di flusso indipendente. Doccino anticalcare in ottone. Flessibile satinato.

	20247001	1.660,00
	20247001NM	1.798,00
	20247001BM	1.798,00
	20247001AC	1.798,00
	20247001KM	1.798,00
	20247001KMB	1.798,00
	20247001OR	2.552,00
	20247001OM	2.552,00
	20247001OP	2.552,00
	20247001OPM	2.552,00

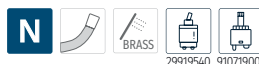

Concealing base for floor installation of single-handle mixer taps

26285350	189,00
	→ 404

Base a incasso per montaggio di miscelatori monocomando a pavimento

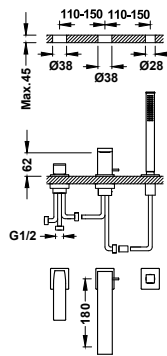

Single-handle bath edge mixer tap

- Inverter integrated into the bath spout.
- Anti-limescale brass hand shower.
- 180 mm bath spout. Water flow: 3 bar - 13 l/min.
- Optional tank kit not included ref: 20224501.

Miscelatore monocomando bordo vasca

- Inverter incorporato nella canna della vasca.
- Doccino anticalcare in ottone.
- Canna della vasca di 180 mm. Flusso: 3 bar - 13 l/m.
- Kit contenitore opzionale non incluso rif: 20224501.

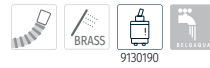

	20216103	450,00
	20216103NM	698,00
	20216103BM	698,00
	20216103AC	698,00
	20216103OR	990,00
	20216103OM	990,00



Tank for bath edge tapware
 Contenitore per kit di miscelazione bordo vasca

	20224501	415,00
--	----------	--------



Click-clack drainage valve for bath with overflow and drainage point
 Valvola di scarico Click-clack per vasca con troppopieno e presa drenaggio

	134445	100,00
--	--------	--------

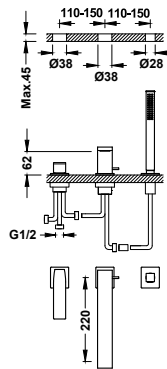

Single-handle bath edge mixer tap

- Inverter integrated into the bath spout.
- Anti-limescale brass hand shower.
- 220 mm bath spout. Water flow: 3 bar - 13 l/min.
- Optional tank kit not included ref: 20224501.

Miscelatore monocomando bordo vasca

- Inverter incorporato nella canna della vasca.
- Doccino anticalcare in ottone.
- Canna della vasca di 220 mm. Flusso: 3 bar - 13 l/m.
- Kit contenitore opzionale non incluso rif: 20224501.



	20216101	460,00
	20216101NM	713,00
	20216101BM	713,00
	20216101AC	713,00
	20216101OR	1.012,00
	20216101OM	1.012,00



Tank for bath edge tapware
 Contenitore per kit di miscelazione bordo vasca

	20224501	415,00
--	----------	--------



Click-clack drainage valve for bath with overflow and drainage point
 Valvola di scarico Click-clack per vasca con troppopieno e presa drenaggio

	134445	100,00
--	--------	--------

THERMOSTATIC WALL TAPS / RUBINETTO TERMOSTATICI A MURO

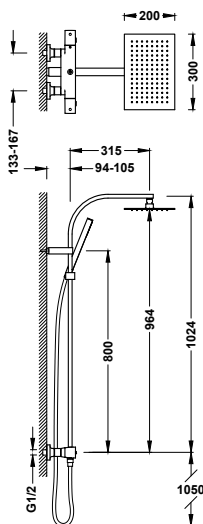

2-way Over-wall thermostatic shower mixer tap set

- With diverter integrated into the flow regulator.
- Square handle.
- Stainless steel adjustable shower head: 300x200 mm.
- Adjustable and sliding support for hand shower.
- Anti-limescale brass hand shower.
- Satin hose.

Set di miscelatore termostatico a muro Over-wall 2 getti per doccia

- Con inverter incorporato nel regolatore di flusso.
- Manopola quadrata.
- Soffione doccia orientabile in acciaio inossidabile: 300x200 mm.
- Supporto scorrevole e orientabile per doccino.
- Doccino anticalcare in ottone.
- Flessibile satinato.



	19039306	671,00
	19039306NM	1.040,00
	19039306BM	1.040,00
	19039306AC	1.040,00
	19039306KMB	1.040,00
	19039306OM	1.476,00

THERMOSTATIC CONCEALED TAPS / RUBINETTI TERMOSTATICI DA INCASSO

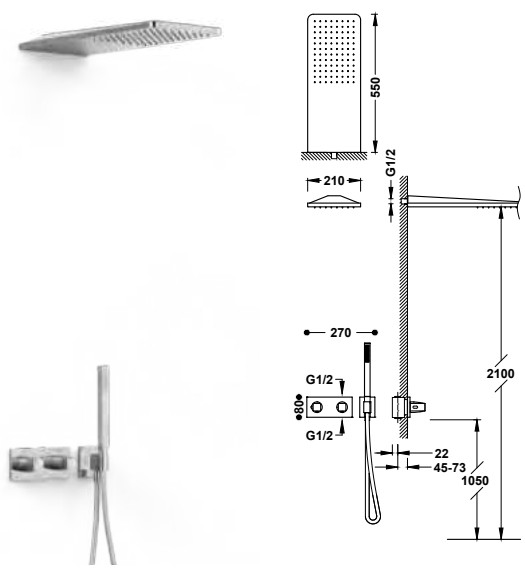

B-system 2-way concealed thermostatic shower mixer tap kit

- Concealed thermostatic body for horizontal installation included.
- Flow regulator and 2-way ceramic distributor.
- Square-round handle.
- Stainless steel wall-mounted shower head: 210x550 mm.
- Wall-mounted support for hand shower with water supply.
- Anti-limescale brass hand shower.
- Satin hose.

Kit di miscelatore termostatico a incasso 2 getti B-system per doccia

- Corpo termostatico a incasso con installazione orizzontale inclusa.
- Regolatore di flusso ed erogatore in ceramica a 2 getti.
- Manopola quadrata-rotonda.
- Soffione doccia a muro in acciaio inossidabile: 210x550 mm.
- Supporto per doccia con presa d'acqua a muro.
- Doccino anticalcare in ottone.
- Flessibile satinato.



30725205	1.116,00
30725205NM	1.730,00
30725205AC	1.730,00
30725205KMB	1.730,00 N
30725205OR	2.456,00
30725205OM	2.456,00
30725205OP	2.456,00
30725205OPM	2.456,00

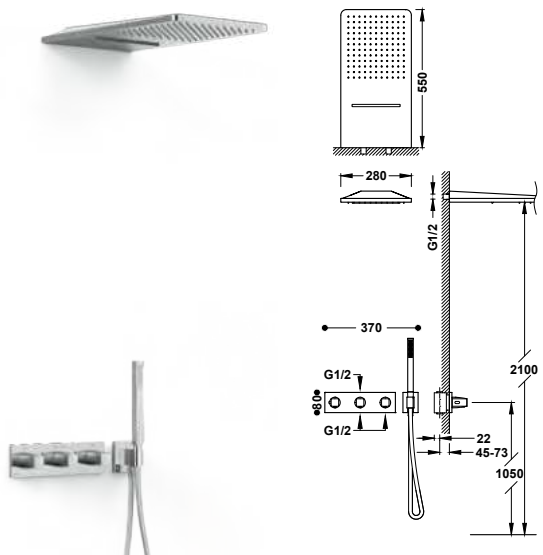

B-system 3-way concealed thermostatic shower mixer tap kit

- Concealed thermostatic body for horizontal installation included.
- Flow regulator and 3-way distributor.
- Square-round handle.
- Stainless steel wall-mounted shower head with 2 stream types (rain/cascade). 280x550 mm. IMPORTANT: Install a >50 l/min drain.
- Wall-mounted support for hand shower with water supply.
- Anti-limescale brass hand shower.
- Satin hose.

Kit di miscelatore termostatico a incasso 3 getti B-system per doccia

- Corpo termostatico a incasso con installazione orizzontale inclusa.
- Regolatore di flusso ed erogatore a 3 getti.
- Manopola quadrata-rotonda.
- Soffione doccia a muro in acciaio inossidabile con 2 tipi di getto (pioggia/cascata). 280x550 mm. IMPORTANTE: Montare uno scarico da >50 l/min.
- Supporto per doccia con presa d'acqua a muro.
- Doccino anticalcare in ottone.
- Flessibile satinato.



30725305	1.410,00
30725305NM	2.172,00
30725305AC	2.172,00
30725305KMB	2.172,00 N
30725305OR	3.083,00
30725305OM	3.083,00
30725305OP	3.083,00
30725305OPM	3.083,00

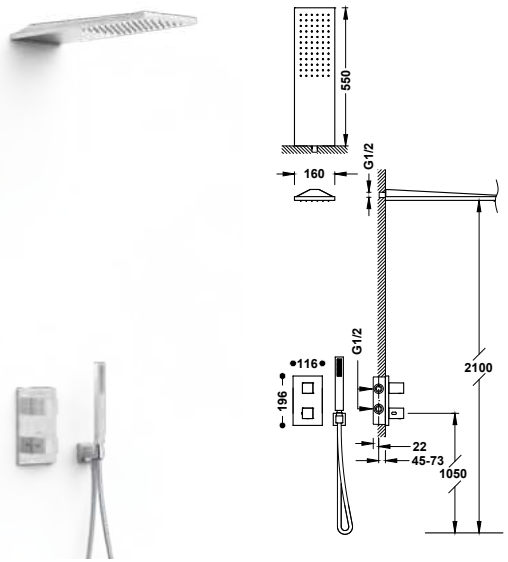

Therm-box 2-way concealed thermostatic tap kit for showers

- Concealed body included.
- Square handle with temperature control. 2-way ceramic distributor.
- Stainless steel wall-mounted shower head: 160x550 mm.
- Wall-mounted support for hand shower with water supply.
- Anti-limescale brass hand shower.
- Satin hose.

Kit di miscelatore termostatico da incasso a 2 getti Therm-box per doccia

- Corpo a incasso incluso.
- Manopola quadrata con controllo della temperatura. Erogatore in ceramica a 2 getti.
- Soffione doccia a muro in acciaio inossidabile: 160x550 mm.
- Supporto per doccia con presa d'acqua a muro.
- Doccino anticalcare in ottone.
- Flessibile satinato.



20225055	829,00
20225055NM	1.216,00
20225055BM	1.216,00
20225055AC	1.216,00
20225055KMB	1.216,00 N
20225055OR	1.672,00
20225055OM	1.672,00

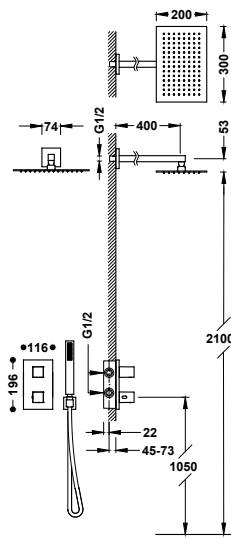

Therm-box 2-way concealed thermostatic tap kit for showers

- Concealed body included.
- Square handle with temperature control. 2-way ceramic distributor.
- Wall-mounted arm with adjustable stainless steel shower head: 300x200 mm.
- Wall-mounted support for hand shower with water supply.
- Anti-limescale brass hand shower.
- Satin hose.

20225054	677,00
20225054NM	975,00
20225054BM	975,00
20225054AC	975,00
20225054OR	1.331,00
20225054OM	1.331,00

**Kit di miscelatore termostatico da incasso a 2 getti
Therm-box per doccia**

- Corpo a incasso incluso.
- Manopola quadrata con controllo della temperatura. Erogatore in ceramica a 2 getti.
- Braccio a muro con soffione doccia orientabile in acciaio inossidabile: 300x200 mm.
- Supporto per doccia con presa d'acqua a muro.
- Doccino anticalcare in ottone.
- Flessibile satinato.

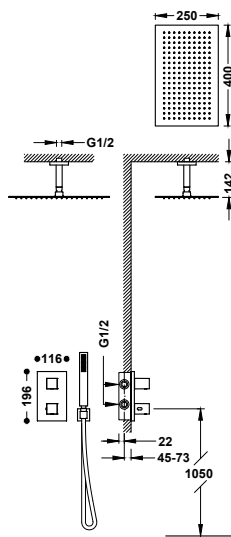

Therm-box 2-way concealed thermostatic tap kit for showers

- Concealed body included.
- Square handle with temperature control. 2-way ceramic distributor.
- Ceiling-mounted arm with adjustable stainless steel shower head: 400x250 mm.
- Wall-mounted support for hand shower with water supply.
- Anti-limescale brass hand shower.
- Satin hose.

20225053	705,00
20225053NM	1.023,00
20225053BM	1.023,00
20225053AC	1.023,00
20225053KMB	1.023,00 N
20225053OR	1.399,00
20225053OM	1.399,00

**Kit di miscelatore termostatico da incasso a 2 getti
Therm-box per doccia**

- Corpo a incasso incluso.
- Manopola quadrata con controllo della temperatura. Erogatore in ceramica a 2 getti.
- Braccio a soffitto con soffione doccia orientabile in acciaio inossidabile: 400x250 mm.
- Supporto per doccia con presa d'acqua a muro.
- Doccino anticalcare in ottone.
- Flessibile satinato.



SHUT-OFF VALVES / VALVOLE DI INTERCETTAZIONE

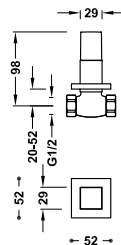

Concealed shut-off valve

Female thread connection: 1/2".

Valvola di intercettazione a incasso

Attacco a filetto femmina: 1/2".

00715501	89,00
00715501NM	137,00
00715501BM	137,00
00715501AC	137,00
00715501OR	196,00
00715501OM	196,00

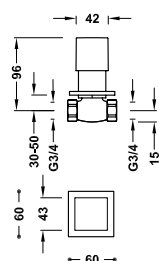

Concealed shut-off valve

Female thread connection: 3/4".

Valvola di intercettazione a incasso

Attacco a filetto femmina: 3/4".

107511	96,00
--------	-------



STUDY

Simple yet extravagant. The cylindrical and slim body of the Study range searches for a timeless balance. A minimalist and harmonious design with metallic finishes that will blow you away.

Semplice e sofisticato. I corpi sottili e cilindrici di Study aspirano a un equilibrio senza tempo. Un design minimalista e armonioso con finiture metalliche che sorprendono.

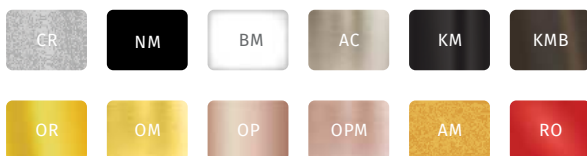





WASHBASIN TAPS / RUBINETTI PER LAVABO

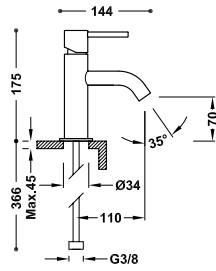

Single-handle washbasin mixer tap

G3/8 flexible hoses.

Miscelatore monocomando per lavabo

Flessibili di alimentazione G3/8.

	26290301	173,00
	26290301D	196,00
	26290301NM	269,00
	26290301BM	269,00
	26290301AC	269,00
	26290301KM	269,00
	26290301KMB	269,00
	26290301OR	381,00
	26290301OM	381,00
	26290301OP	381,00
	26290301OPM	381,00
	26290301TAM	269,00
	26290301TRO	269,00

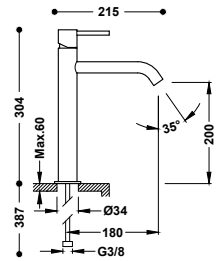

High single-handle washbasin mixer tap

G3/8 flexible hoses.

Miscelatore monocomando alto per lavabo

Flessibili di alimentazione G3/8.

	26230701	312,00
	26230701NM	483,00
	26230701BM	483,00
	26230701AC	483,00
	26230701KM	483,00
	26230701KMB	483,00
	26230701OR	686,00
	26230701OM	686,00
	26230701OP	686,00
	26230701OPM	686,00
	26230701TAM	483,00
	26230701TRO	483,00

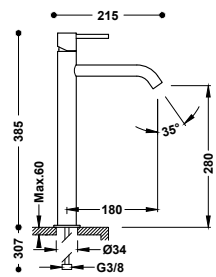

XXL single-handle washbasin mixer tap

G3/8 flexible hoses.

Miscelatore monocomando XXL per lavabo

Flessibili di alimentazione G3/8.

	26230801	341,00
	26230801NM	529,00
	26230801BM	529,00
	26230801AC	529,00
	26230801KM	529,00
	26230801KMB	529,00
	26230801OR	751,00
	26230801OM	751,00
	26230801OP	751,00
	26230801OPM	751,00
	26230801TAM	529,00
	26230801TRO	529,00

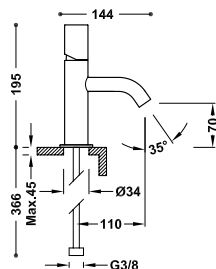

Single-handle washbasin mixer tap

G3/8 flexible hoses.

Miscelatore monocomando per lavabo

Flessibili di alimentazione G3/8.

	26190301	173,00
	26190301D	196,00
	26190301NM	269,00
	26190301BM	269,00
	26190301AC	269,00
	26190301KM	269,00
	26190301KMB	269,00
	26190301OR	381,00
	26190301OM	381,00
	26190301OP	381,00
	26190301OPM	381,00
	26190301TAM	269,00
	26190301TRO	269,00

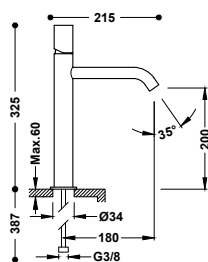

High single-handle washbasin mixer tap

G3/8 flexible hoses.

Miscelatore monocomando alto per lavabo

Flessibili di alimentazione G3/8.



- 26130701 312,00
- 26130701NM 483,00
- 26130701BM 483,00
- 26130701AC 483,00
- 26130701KM 483,00
- 26130701KMB 483,00
- 26130701OR 686,00
- 26130701OM 686,00
- 26130701OP 686,00
- 26130701OPM 686,00
- 26130701TAM 483,00
- 26130701TRO 483,00

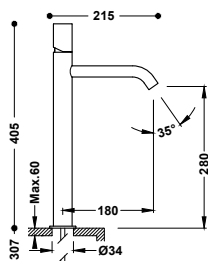

XXL single-handle washbasin mixer tap

G3/8 flexible hoses.

Miscelatore monocomando XXL per lavabo

Flessibili di alimentazione G3/8.



- 26130801 341,00
- 26130801NM 529,00
- 26130801BM 529,00
- 26130801AC 529,00
- 26130801KM 529,00
- 26130801KMB 529,00
- 26130801OR 751,00
- 26130801OM 751,00
- 26130801OP 751,00
- 26130801OPM 751,00
- 26130801TAM 529,00
- 26130801TRO 529,00

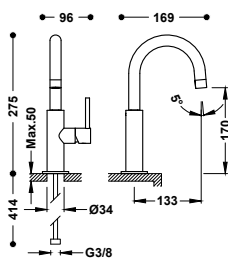

Single-handle washbasin mixer tap with lateral lever

G3/8 flexible hoses.

Miscelatore monocomando con leva laterale per lavabo

Flessibili di alimentazione G3/8.



- 26290403 221,00
- 26290403NM 342,00
- 26290403BM 342,00
- 26290403AC 342,00
- 26290403KM 342,00
- 26290403KMB 342,00
- 26290403OR 485,00
- 26290403OM 485,00
- 26290403OP 485,00
- 26290403OPM 485,00
- 26290403TAM 342,00
- 26290403TRO 342,00

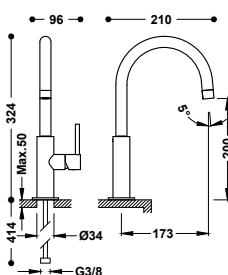

High single-handle washbasin mixer tap with lateral lever

G3/8 flexible hoses.

Miscelatore monocomando alto con leva laterale per lavabo

Flessibili di alimentazione G3/8.



- 26290402 231,00
- 26290402NM 358,00
- 26290402BM 358,00
- 26290402AC 358,00
- 26290402KM 358,00
- 26290402KMB 358,00
- 26290402OR 508,00
- 26290402OM 508,00
- 26290402OP 508,00
- 26290402OPM 508,00
- 26290402TAM 358,00
- 26290402TRO 358,00

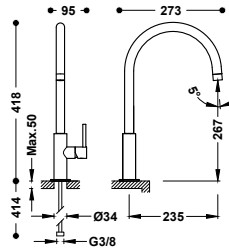

XXL single-handle washbasin mixer tap with lateral lever

G3/8 flexible hoses.

Miscelatore monocomando XXL con leva laterale per lavabo

Flessibili di alimentazione G3/8.



26290401	242,00
26290401NM	374,00
26290401BM	374,00
26290401AC	374,00
26290401KM	374,00
26290401KMB	374,00
26290401OR	531,00
26290401OM	531,00
26290401OP	531,00
26290401OPM	531,00
26290401TAM	374,00
26290401TRO	374,00

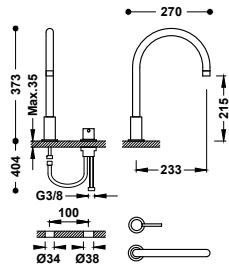

Deck-mounted 2-hole basin mixer

Can be freely installed.

Miscelatore monocomando bordo lavabo

Libera installazione.



26110501	236,00
26110501NM	366,00
26110501BM	366,00
26110501AC	366,00
26110501KM	366,00
26110501KMB	366,00
26110501OR	520,00
26110501OM	520,00
26110501OP	520,00
26110501OPM	520,00

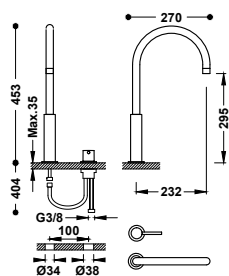

High deck-mounted 2-hole basin mixer

Can be freely installed.

Miscelatore monocomando alto bordo lavabo

Libera installazione.



26110502	252,00
26110502NM	391,00
26110502BM	391,00
26110502AC	391,00
26110502KM	391,00
26110502KMB	391,00
26110502OR	554,00
26110502OM	554,00
26110502OP	554,00
26110502OPM	554,00

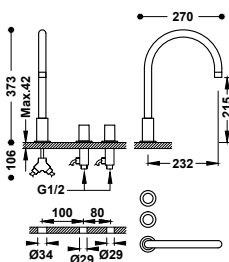

Deck-mounted 3-hole basin mixer

Can be freely installed. With handles.

Miscelatore bicomando bordo lavabo

Libera installazione. Con manopole.



06110501	278,00
06110501NM	431,00
06110501BM	431,00
06110501AC	431,00
06110501KM	431,00
06110501KMB	431,00
06110501OR	612,00
06110501OM	612,00
06110501OP	612,00
06110501OPM	612,00

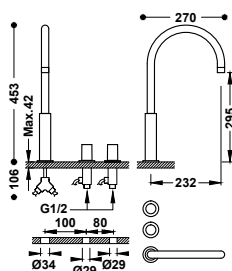

High deck-mounted 3-hole basin mixer

Can be freely installed. With handles.

Miscelatore bicomando alto bordo lavabo

Libera installazione. Con manopole.



06110502	294,00
06110502NM	456,00
06110502BM	456,00
06110502AC	456,00
06110502KM	456,00
06110502KMB	456,00
06110502OR	647,00
06110502OM	647,00
06110502OP	647,00
06110502OPM	647,00

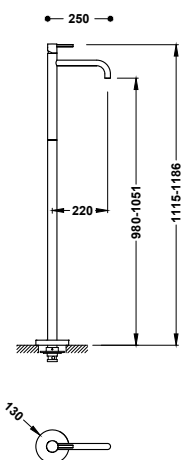

Single-handle washbasin mixer tap with floor water supply

Concealed box not included (Ref. 26285350). 1 floor-mounted vertical water supply column.

Miscelatore monocomando con presa a terra per lavabo

Scatola incassata (Ref. 26285350) non inclusa. 1 colonna verticale di alimentazione dell'acqua a terra.



26285305	578,00
26285305NM	895,00
26285305BM	895,00
26285305AC	895,00
26285305KM	895,00
26285305KMB	895,00
26285305OR	1.271,00
26285305OM	1.271,00
26285305OP	1.271,00
26285305OPM	1.271,00



Concealing base for floor installation of single-handle mixer taps

26285350	189,00
→404	

Base a incasso per montaggio di miscelatori monocomando a pavimento

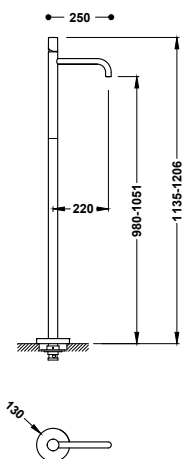

Single-handle washbasin mixer tap with floor water supply

Concealed box not included (Ref. 26285350). 1 floor-mounted vertical water supply column.

Miscelatore monocomando con presa a terra per lavabo

Scatola incassata (Ref. 26285350) non inclusa. 1 colonna verticale di alimentazione dell'acqua a terra.



26285306	578,00
26285306NM	895,00
26285306BM	895,00
26285306AC	895,00
26285306KM	895,00
26285306KMB	895,00
26285306OR	1.271,00
26285306OM	1.271,00
26285306OP	1.271,00
26285306OPM	1.271,00



Concealing base for floor installation of single-handle mixer taps

26285350	189,00
→404	

Base a incasso per montaggio di miscelatori monocomando a pavimento

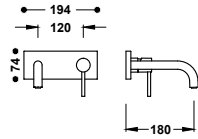

Visible part for recessed sink body

Visible part only. Includes concealing plate, handle and 180 mm spout. Recessed body not included.

Elemento a vista per il corpo a incasso da lavello

Solo parte a vista. Include piastra decorativa, comando e beccuccio da 180 mm. Corpo a incasso non incluso.



26230031	215,00
26230031NM	333,00
26230031BM	333,00
26230031AC	333,00
26230031KM	333,00
26230031KMB	333,00
26230031OR	473,00
26230031OM	473,00
26230031OP	473,00
26230031OPM	473,00



Recessed body for sink tap

20830002 85,00

Corpo a incasso per rubinetto da lavello

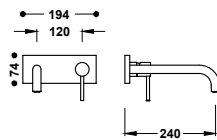

Visible part for recessed sink body

Visible part only. Includes concealing plate, handle and 240 mm spout. Recessed body not included.

Elemento a vista per il corpo a incasso da lavello

Solo parte a vista. Include piastra decorativa, comando e beccuccio da 240 mm. Corpo a incasso non incluso.



26230032	225,00
26230032NM	349,00
26230032BM	349,00
26230032AC	349,00
26230032KM	349,00
26230032KMB	349,00
26230032OR	450,00
26230032OM	495,00
26230032OP	495,00
26230032OPM	495,00



Recessed body for sink tap

20830002 85,00

Corpo a incasso per rubinetto da lavello

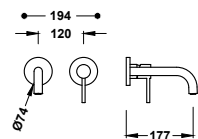

Visible part for recessed sink body

Visible part only. Includes concealing plate, handle and 177 mm spout. Recessed body not included.

Elemento a vista per il corpo a incasso da lavello

Solo parte a vista. Include piastra decorativa, comando e beccuccio da 177 mm. Corpo a incasso non incluso.



26230021	177,00
26230021NM	274,00
26230021BM	274,00
26230021AC	274,00
26230021KM	274,00
26230021KMB	274,00
26230021OR	389,00
26230021OM	389,00
26230021OP	389,00
26230021OPM	389,00



Recessed body for sink tap

20830002 85,00

Corpo a incasso per rubinetto da lavello

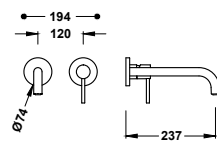

Visible part for recessed sink body

Visible part only. Includes concealing plate, handle and 237 mm spout. Recessed body not included.

Elemento a vista per il corpo a incasso da lavello

Solo parte a vista. Include piastra decorativa, comando e beccuccio da 237 mm. Corpo a incasso non incluso.



26230022	187,00
26230022NM	290,00
26230022BM	290,00
26230022AC	290,00
26230022KM	290,00
26230022KMB	290,00
26230022OR	411,00
26230022OM	411,00
26230022OP	411,00
26230022OPM	411,00



Recessed body for sink tap

20830002 85,00

Corpo a incasso per rubinetto da lavello

BIDET TAPS / RUBINETTI PER BIDET

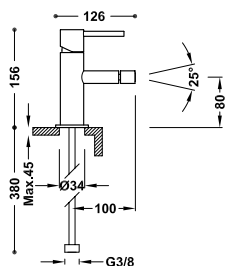

Single-handle bidet mixer tap

Adjustable shower head. G3/8 flexible hoses.

Miscelatore monocomando per bidet

Supporto orientabile. Flessibili di alimentazione G3/8.



	26212001	176,00
	26212001D	200,00
	06212001NM	273,00
	06212001BM	273,00
	06212001AC	273,00
	06212001KM	273,00
	06212001KMB	273,00
	06212001OR	388,00
	06212001OM	388,00
	06212001OP	388,00
	06212001OPM	388,00
	06212001TAM	273,00
	06212001TRO	273,00

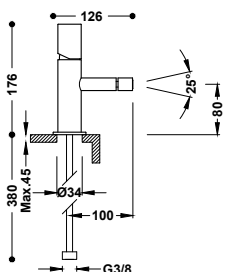

Single-handle bidet mixer tap

Adjustable shower head. G3/8 flexible hoses.

Miscelatore monocomando per bidet

Supporto orientabile. Flessibili di alimentazione G3/8.



	26112001	176,00
	26112001D	200,00
	06112001NM	273,00
	06112001BM	273,00
	06112001AC	174,00
	06112001KM	273,00
	06112001KMB	273,00
	06112001OR	388,00
	06112001OM	388,00
	06112001OP	388,00
	06112001OPM	388,00
	06112001TAM	273,00
	06112001TRO	273,00

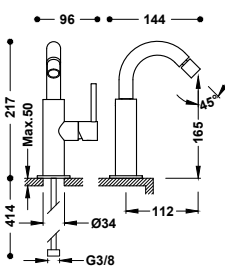

Single-handle bidet mixer tap with lateral lever

Adjustable shower head. G3/8 flexible hoses.

Miscelatore monocomando con leva laterale per bidet

Supporto orientabile. Flessibili di alimentazione G3/8.

	26222402	221,00
	26222402NM	342,00
	26222402BM	342,00
	26222402AC	342,00
	26222402KM	342,00
	26222402KMB	342,00
	26222402OR	485,00
	26222402OM	485,00
	26222402OP	485,00
	26222402OPM	485,00
	26222402TAM	342,00
	26222402TRO	342,00

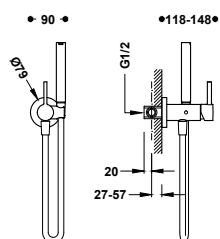

Concealed single lever WC/ bidet mixer

With cold and hot water. Hand shower with 5 l/min limiter coupling and non-drip system. Fixed support for hand shower for installation on right or left. Satin hose.

Miscelatore monocomando con doccia per wc

Con acqua fredda e calda. Doccino con limitatore a 5 l/min. e sistema antigocciolamento. Supporto fisso per doccia installabile a destra o a sinistra. Flessibile satinato.



	134123	190,00
	134123NM	295,00
	134123BM	295,00
	134123AC	295,00
	134123KM	295,00
	134123KMB	295,00
	134123OR	418,00
	134123OM	418,00
	134123OP	418,00
	134123OPM	418,00

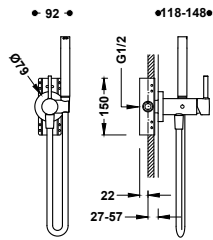

Concealed single lever WC/ bidet mixer

Option for plasterboard walls. With cold and hot water. Hand shower with 5 l/min limiter coupling and non-drip system. Fixed support for hand shower for installation on right or left. Satin hose.

134122	230,00
134122NM	357,00
134122BM	357,00
134122AC	357,00

Miscelatore monocomando con doccia per wc

Opzione per pareti in cartongesso. Con acqua fredda e calda. Doccia con limitatore a 5 l/min. e sistema antigocciolamento. Supporto fisso per doccia installabile a destra o a sinistra. Flessibile satinato.



9134591



Towel holder accessory for toilet mixer tap with shower

Installable support for right or left side (for ref.: 134122, 134123, 181122, 181123, 181222, 181223, 20522201, 20522301). Length: 180 mm.

03412401	37,00
03412401NM	57,00
03412401BM	57,00
03412401AC	57,00
03412401KM	57,00
03412401KMB	57,00
03412401OR	81,00
03412401OM	81,00
03412401OP	81,00
03412401OPM	81,00

Portasciugamano per rubinetto con doccia per wc

Supporto installabile a destra o a sinistra (per rif.: 134122, 134123, 181122, 181123, 181222, 181223, 20522201, 20522301). Lungh.: 180 mm.

WALL TAPS / RUBINETTI A MURO

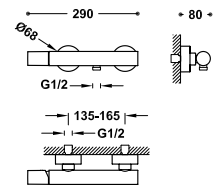

Wall-mounted single-handle shower mixer tap

Anti-limescale hand shower. Adjustable support for hand shower. Satin hose.

26116701	278,00
26116701NM	431,00
26116701BM	431,00
26116701AC	431,00
26116701KM	431,00
26116701KMB	431,00
26116701OR	612,00
26116701OM	612,00
26116701OP	612,00
26116701OPM	612,00
26116701TAM	431,00
26116701TRO	431,00

Miscelatore monocomando a muro per doccia

Doccia anticalcare. Supporto orientabile per doccia. Flessibile satinato.



9130190

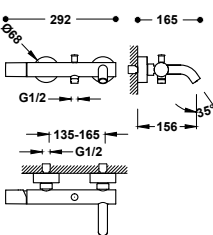

Wall-mounted single-handle mixer tap for bath and shower

Anti-limescale hand shower. Adjustable support for hand shower. Satin hose.

26117001	299,00
26117001NM	464,00
26117001BM	464,00
26117001AC	464,00
26117001KM	464,00
26117001KMB	464,00
26117001OR	658,00
26117001OM	658,00
26117001OP	658,00
26117001OPM	658,00
26117001TAM	464,00
26117001TRO	464,00

Miscelatore monocomando a muro per vasca e doccia

Doccia anticalcare. Supporto orientabile per doccia. Flessibile satinato.



9130190

CONCEALED TAPS/ RUBINETTI DA INCASSO

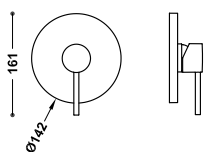

Visible part for concealed 1-way Rapid-box

Only visible part. Includes trim plate, control, bush and concealed attachment screw. Complete with concealed Rapid-box ref.: 20827810.

Pezzo vista per cassa da incasso a 1 via Rapid-box

Solo parte vista. Include piastra decorativa, comando, boccola e vite di fissaggio occulta. Completare con scatola da incasso Rapid-box rif.: 20827810.

	26227810	89,00
	26227810NM	138,00
	26227810BM	138,00
	26227810AC	138,00
	26227810KM	138,00
	26227810KMB	138,00
	26227810OR	196,00
	26227810OM	196,00
	26227810OP	196,00
	26227810OPM	196,00



Concealed 1-way Rapid-box with single-handle mixer tap for shower

20827810 80,00

Scatola da incasso a 1 via Rapid-box con miscelatore monocomando per doccia

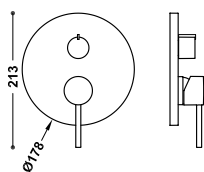

Visible part for concealed 2-way Rapid-box

Only visible part. Includes trim plate, control, distribution handle and concealed attachment screw. Complete with concealed Rapid-box ref.: 20828110.

Pezzo vista per cassa da incasso a 2 vie Rapid-box

Solo parte vista. Include piastra decorativa, comando, volante distributore e vite di fissaggio occulta. Completare con scatola da incasso Rapid-box rif.: 20828110.

	26228110	116,00
	26228110NM	179,00
	26228110BM	179,00
	26228110AC	179,00
	26228110KM	179,00
	26228110KMB	179,00
	26228110OR	254,00
	26228110OM	254,00
	26228110OP	254,00
	26228110OPM	254,00



Concealed 2-way Rapid-box with single-handle mixer tap for shower and bath

20828110 90,00

Scatola da incasso a 2 vie Rapid-box con miscelatore monocomando per doccia e vasca da bagno

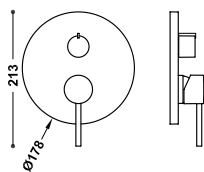

Visible part for concealed 3-way Rapid-box

Only visible part. Includes trim plate, control, distribution handle and concealed attachment screw. Complete with concealed Rapid-box ref.: 20827310.

Pezzo vista per cassa da incasso a 3 vie Rapid-box

Solo parte vista. Include piastra decorativa, comando, volante distributore e vite di fissaggio occulta. Completare con scatola da incasso Rapid-box rif.: 20827310.

	26227310	125,00
	26227310NM	194,00
	26227310BM	194,00
	26227310AC	194,00
	26227310KM	194,00
	26227310KMB	194,00
	26227310OR	275,00
	26227310OP	275,00
	26227310OM	275,00
	26227310OPM	275,00



Concealed 3-way Rapid-box with single-handle mixer tap for shower and bath

20827310 95,00

Scatola da incasso a 3 vie Rapid-box con miscelatore monocomando per doccia e vasca da bagno

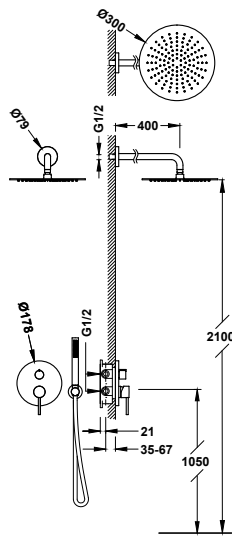

Rapid-box 2-way concealed single-handle shower mixer tap kit

- Concealed body included.
- 2-way ceramic distributor.
- Wall-mounted arm with adjustable stainless steel shower head: Ø 300 mm.
- Wall-mounted support for hand shower with water supply.
- Anti-limescale brass hand shower.
- Satin hose.

Kit di miscelatore monocomando a incasso 2 getti Rapid-box per doccia

- Corpo a incasso incluso.
- Erogatore in ceramica a 2 getti.
- Braccio a muro con soffione doccia orientabile in acciaio inossidabile: Ø 300 mm.
- Supporto per doccia con presa d'acqua a muro.
- Doccino anticalcare in ottone.
- Flessibile satinato.



26228004	495,00
26228004NM	712,00
26228004BM	712,00
26228004AC	712,00
26228004KM	712,00
26228004KMB	712,00
26228004OR	977,00
26228004OM	977,00
26228004OP	977,00
26228004OPM	977,00

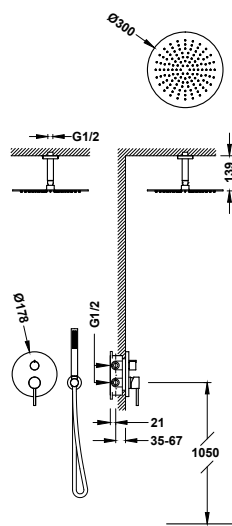

Rapid-box 2-way concealed single-handle shower mixer tap kit

- Concealed body included.
- 2-way ceramic distributor.
- Ceiling-mounted arm with adjustable stainless steel shower head: Ø 300 mm.
- Wall-mounted support for hand shower with water supply.
- Anti-limescale brass hand shower.
- Satin hose.

Kit di miscelatore monocomando a incasso 2 getti Rapid-box per doccia

- Corpo a incasso incluso.
- Erogatore in ceramica a 2 getti.
- Braccio a soffitto con soffione doccia orientabile in acciaio inossidabile: Ø 300 mm.
- Supporto per doccia con presa d'acqua a muro.
- Doccino anticalcare in ottone.
- Flessibile satinato.



26228003	473,00
26228003NM	675,00
26228003BM	675,00
26228003AC	675,00
26228003KM	675,00
26228003KMB	675,00
26228003OR	924,00
26228003OM	924,00
26228003OP	924,00
26228003OPM	924,00

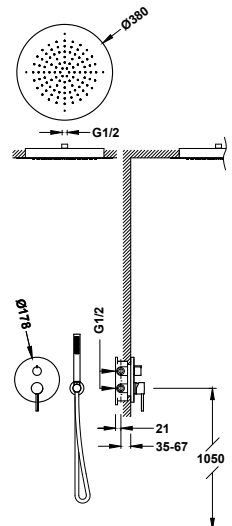

Rapid-box 2-way concealed single-handle shower mixer tap kit

- Concealed body included.
- 2-way ceramic distributor.
- Concealed stainless steel ceiling-mounted shower head: Ø 380 mm.
- Wall-mounted support for hand shower with water supply.
- Anti-limescale brass hand shower.
- Satin hose.

Kit di miscelatore monocomando a incasso 2 getti Rapid-box per doccia

- Corpo a incasso incluso.
- Erogatore in ceramica a 2 getti.
- Soffione doccia soffitto a incasso in acciaio inossidabile: Ø 380 mm.
- Supporto per doccia con presa d'acqua a muro.
- Doccino anticalcare in ottone.
- Flessibile satinato.



26228005	1.026,00
26228005NM	1.546,00
26228005BM	1.546,00
26228005AC	1.546,00
26228005KM	1.546,00
26228005KMB	1.546,00
26228005OR	2.160,00
26228005OM	2.160,00
26228005OP	2.160,00
26228005OPM	2.160,00

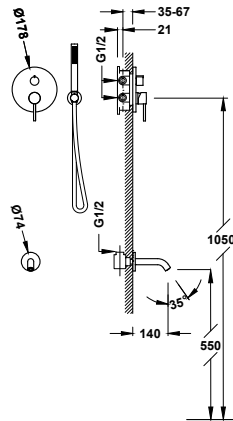

Rapid-box 2-way concealed single-handle mixer tap kit for bath and shower

- Concealed body included.
- 2-way ceramic distributor.
- Fixed wall-mounted spout.
- Wall-mounted support for hand shower with water supply.
- Anti-limescale brass hand shower.
- Satin hose.

Kit di miscelatore monocomando a incasso a 2 getti Rapid-box per vasca e doccia

- Corpo a incasso incluso.
- Erogatore in ceramica a 2 getti.
- Canna fissa a muro.
- Supporto per doccia con presa d'acqua a muro.
- Doccino anticalcare in ottone.
- Flessibile satinato.

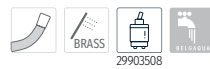

	26228006	381,00
	26228006NM	545,00
	26228006BM	545,00
	26228006AC	545,00
	26228006KM	545,00
	26228006KMB	545,00
	26228006OR	740,00
	26228006OM	740,00
	26228006OP	740,00
	26228006OPM	740,00

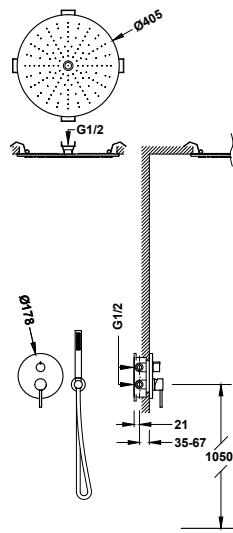

Rapid-box 3-way concealed single-handle shower mixer tap kit

- Concealed body included.
- 3-way ceramic distributor.
- Stainless steel concealed ceiling-mounted shower head with 2 stream types (rain/free flow). Ø 405 mm.
- Wall-mounted support for hand shower with water supply.
- Anti-limescale brass hand shower.
- Satin hose.

Kit di miscelatore monocomando a incasso 3 getti Rapid-box per doccia

- Corpo a incasso incluso.
- Erogatore in ceramica a 3 getti.
- Soffione doccia a incasso da soffitto in acciaio inossidabile con 2 tipi di getto (pioggia/free flow). Ø 405 mm.
- Supporto per doccia con presa d'acqua a muro.
- Doccino anticalcare in ottone.
- Flessibile satinato.



	26227301	1.164,00
	26227301NM	1.754,00
	26227301BM	1.754,00
	26227301AC	1.754,00
	26227301KM	1.754,00
	26227301KMB	1.754,00
	26227301OR	2.450,00
	26227301OP	2.450,00
	26227301OM	2.450,00
	26227301OPM	2.450,00

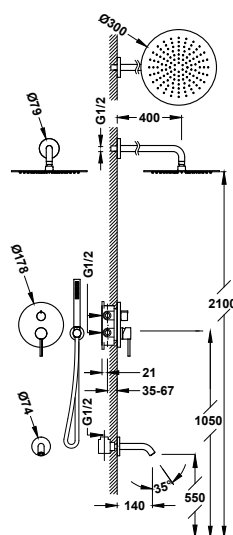

Rapid-box 3-way concealed single-handle shower mixer tap kit

- Concealed body included.
- 3-way ceramic distributor.
- Wall-mounted arm with adjustable stainless steel shower head: Ø 300 mm.
- Fixed wall-mounted spout.
- Wall-mounted support for hand shower with water supply.
- Anti-limescale brass hand shower.
- Satin hose.

Kit di miscelatore monocomando a incasso 3 getti Rapid-box per doccia

- Corpo a incasso incluso.
- Erogatore in ceramica a 3 getti.
- Braccio a muro con soffione doccia orientabile in acciaio inossidabile: Ø 300 mm.
- Canna fissa a muro.
- Supporto per doccia con presa d'acqua a muro.
- Doccino anticalcare in ottone.
- Flessibile satinato.



	26227302	663,00
	26227302NM	946,00
	26227302BM	946,00
	26227302AC	946,00
	26227302KM	946,00
	26227302KMB	946,00
	26227302OR	1.304,00
	26227302OP	1.304,00
	26227302OM	1.304,00
	26227302OPM	1.304,00

BATH TAPS / RUBINETTI PER VASCA

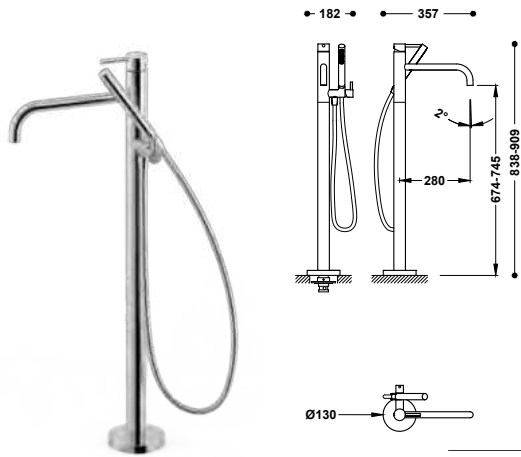

Floorstanding bathtub mixer

Concealed box not included (ref. 26285350). 1 floor-mounted vertical water supply column. Support for hand shower with independent flow regulation and closure. Anti-limescale brass hand shower. Satin hose.

Miscelatore monocomando da pavimento per vasca e doccia

Scatola incassata (ref. 26285350) non inclusa. 1 colonna verticale di alimentazione dell'acqua a terra. Supporto per doccia con chiusura e regolazione di flusso indipendente. Doccino anticalcare in ottone. Flessibile satinato.

26247005	1.103,00
26247005NM	1.709,00
26247005BM	1.709,00
26247005AC	1.709,00
26247005KM	1.709,00
26247005KMB	1.709,00
26247005OR	2.426,00
26247005OM	2.426,00
26247005OP	2.426,00
26247005OPM	2.426,00



Concealing base for floor installation of single-handle mixer taps

26285350	189,00
→ 404	

Base a incasso per montaggio di miscelatori monocomando a pavimento

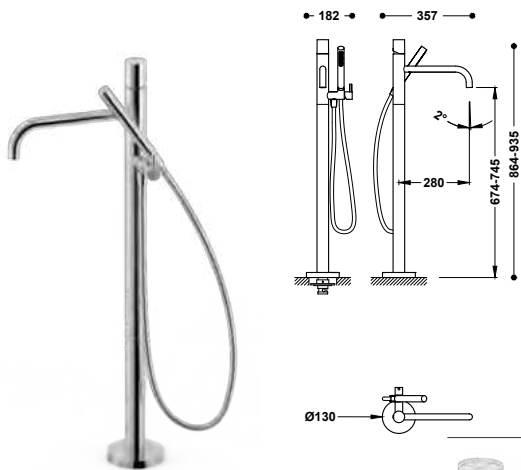

Floorstanding bathtub mixer

Concealed box not included (ref. 26285350). 1 floor-mounted vertical water supply column. Support for hand shower with independent flow regulation and closure. Anti-limescale brass hand shower. Satin hose.

Miscelatore monocomando da pavimento per vasca e doccia

Scatola incassata (ref. 26285350) non inclusa. 1 colonna verticale di alimentazione dell'acqua a terra. Supporto per doccia con chiusura e regolazione di flusso indipendente. Doccino anticalcare in ottone. Flessibile satinato.

26247006	1.103,00
26247006NM	1.709,00
26247006BM	1.709,00
26247006AC	1.709,00
26247006KM	1.709,00
26247006KMB	1.709,00
26247006OR	2.426,00
26247006OM	2.426,00
26247006OP	2.426,00
26247006OPM	2.426,00



Concealing base for floor installation of single-handle mixer taps

26285350	189,00
→ 404	

Base a incasso per montaggio di miscelatori monocomando a pavimento

THERMOSTATIC WALL TAPS / RUBINETTO TERMOSTATICI A MURO

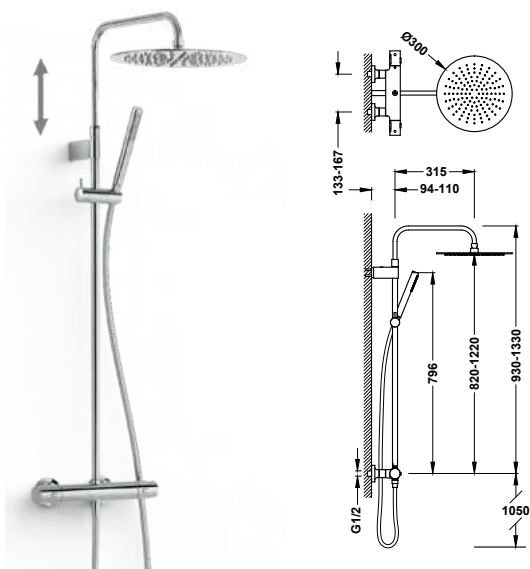

2-way Over-wall thermostatic shower mixer tap set

- With diverter integrated into the flow regulator.
- Round handle.
- Telescopic shower bar.
- Stainless steel adjustable shower head: Ø 300 mm.
- Adjustable and sliding support for hand shower.
- Anti-limescale brass hand shower.
- Satin hose.

Set di miscelatore termostatico a muro Over-wall 2 getti per doccia

- Con inverter incorporato nel regolatore di flusso.
- Manopola rotonda.
- Colonna doccia telescopica.
- Soffione doccia orientabile in acciaio inossidabile: Ø 300 mm.
- Supporto scorrevole e orientabile per doccia.
- Doccino anticalcare in ottone.
- Flessibile satinato.

19039302	559,00
19039302NM	866,00
19039302BM	866,00
19039302AC	866,00
19039302KMB	866,00
19039302OM	1.230,00
19039302OPM	1.230,00



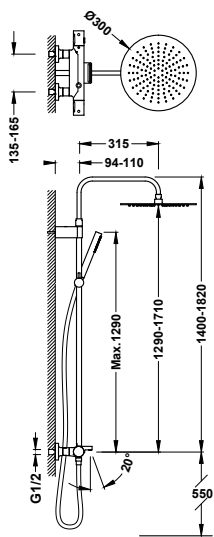

3-way Over-wall thermostatic mixer tap set for bath and shower

- With diverter integrated into the flow regulator.
- Round handle.
- Telescopic shower bar.
- Stainless steel adjustable shower head: Ø 300 mm.
- Adjustable and sliding support for hand shower.
- Anti-limescale brass hand shower.
- Satin hose.

19031212	654,00
19031212NM	1.014,00
19031212BM	1.014,00
19031212AC	1.014,00
19031212KMB	1.014,00
19031212OM	1.439,00
19031212OPM	1.439,00

Set di miscelatore termostatico a muro Over-wall 3 getti per vasca e doccia

- Inverter incorporato nel regolatore di flusso.
- Manopola rotonda.
- Colonna doccia telescopica.
- Soffione doccia orientabile in acciaio inossidabile: Ø 300 mm.
- Supporto scorrevole e orientabile per doccia.
- Doccino anticalcare in ottone.
- Flessibile satinato.

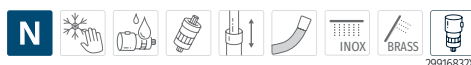

THERMOSTATIC CONCEALED TAPS / RUBINETTI TERMOSTATICI DA INCASSO

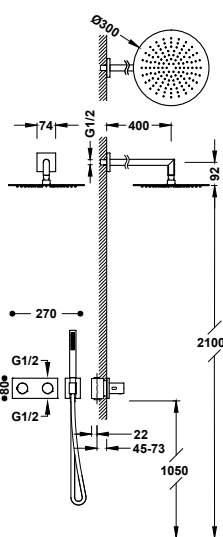

B-system 2-way concealed thermostatic shower mixer tap kit

- Concealed thermostatic body for horizontal installation included.
- Flow regulator and 2-way ceramic distributor.
- Round handle.
- Wall-mounted arm with adjustable stainless steel shower head: Ø 300 mm.
- Wall-mounted support for hand shower with water supply.
- Anti-limescale brass hand shower.
- Satin hose.

30735204	811,00
30735204NM	1.163,00
30735204AC	1.163,00
30735204OR	1.651,00
30735204OM	1.651,00
30735204OP	1.651,00
30735204OPM	1.651,00

Kit di miscelatore termostatico a incasso 2 getti B-system per doccia

- Corpo termostatico a incasso con installazione orizzontale inclusa.
- Regolatore di flusso ed erogatore in ceramica a 2 getti.
- Manopola rotonda.
- Braccio a muro con soffione doccia orientabile in acciaio inossidabile: Ø 300 mm.
- Supporto per doccia con presa d'acqua a muro.
- Doccino anticalcare in ottone.
- Flessibile satinato.

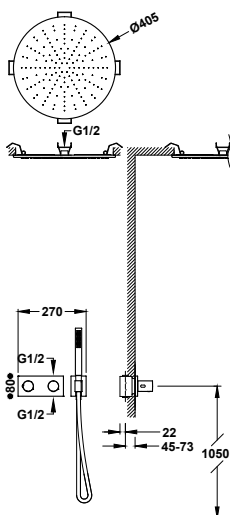

B-system 2-way concealed thermostatic shower mixer tap kit

- Concealed thermostatic body for horizontal installation included.
- Flow regulator and 2-way ceramic distributor.
- Round handle.
- Concealed stainless steel ceiling-mounted shower head: Ø 405 mm.
- Wall-mounted support for hand shower with water supply.
- Anti-limescale brass hand shower.
- Satin hose.

30735206	1.329,00
30735206NM	1.966,00
30735206AC	1.966,00
30735206OR	2.790,00
30735206OM	2.790,00
30735206OP	2.790,00
30735206OPM	2.790,00

Kit di miscelatore termostatico a incasso 2 getti B-system per doccia

- Corpo termostatico a incasso con installazione orizzontale inclusa.
- Regolatore di flusso ed erogatore in ceramica a 2 getti.
- Manopola rotonda.
- Soffione doccia soffitto a incasso in acciaio inossidabile: Ø 405 mm.
- Supporto per doccia con presa d'acqua a muro.
- Doccino anticalcare in ottone.
- Flessibile satinato.



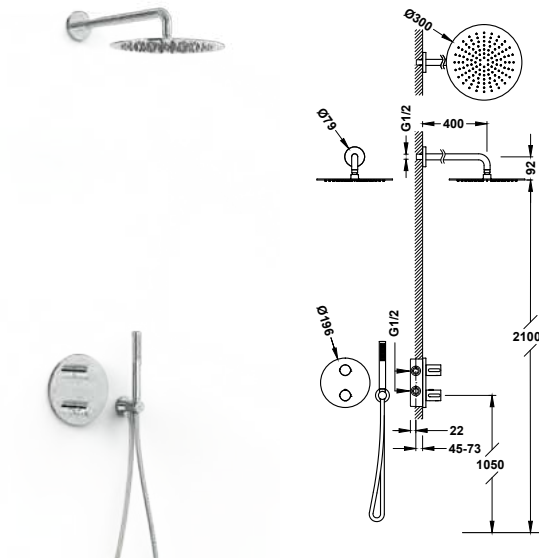

Therm-box 2-way concealed thermostatic tap kit for showers

- Concealed body included.
- Round handle with temperature control. 2-way ceramic distributor.
- Wall-mounted arm with adjustable stainless steel shower head: Ø 300 mm.
- Wall-mounted support for hand shower with water supply.
- Anti-limescale brass hand shower.
- Satin hose.

**Kit di miscelatore termostatico da incasso a 2 getti
Therm-box per doccia**

- Corpo a incasso incluso.
- Manopola rotonda con controllo della temperatura. Erogatore in ceramica a 2 getti.
- Braccio a muro con soffione doccia orientabile in acciaio inossidabile: Ø 300 mm.
- Supporto per doccia con presa d'acqua a muro.
- Doccino anticalcare in ottone.
- Flessibile satinato.



26225004	585,00
26225004NM	837,00
26225004BM	837,00
26225004AC	837,00
26225004KM	837,00
26225004KMB	837,00
26225004OR	1.136,00
26225004OM	1.136,00
26225004OP	1.136,00
26225004OPM	1.136,00

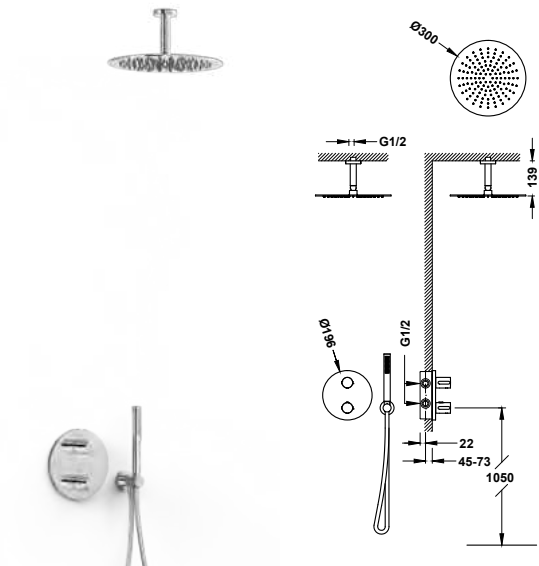

Therm-box 2-way concealed thermostatic tap kit for showers

- Concealed body included.
- Round handle with temperature control. 2-way ceramic distributor.
- Ceiling-mounted arm with adjustable stainless steel shower head: Ø 300 mm.
- Wall-mounted support for hand shower with water supply.
- Anti-limescale brass hand shower.
- Satin hose.

**Kit di miscelatore termostatico da incasso a 2 getti
Therm-box per doccia**

- Corpo a incasso incluso.
- Manopola rotonda con controllo della temperatura. Erogatore in ceramica a 2 getti.
- Braccio a soffitto con soffione doccia orientabile in acciaio inossidabile: Ø 300 mm.
- Supporto per doccia con presa d'acqua a muro.
- Doccino anticalcare in ottone.
- Flessibile satinato.



26225003	558,00
26225003NM	797,00
26225003BM	797,00
26225003AC	797,00
26225003KM	797,00
26225003KMB	797,00
26225003OR	1.078,00
26225003OM	1.078,00
26225003OP	1.078,00
26225003OPM	1.078,00

SHUT-OFF VALVES / VALVOLE DI INTERCETTAZIONE

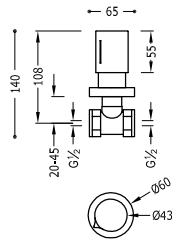

Concealed shut-off valve

Female thread connection: 1/2".

Valvola di intercettazione a incasso

Attacco a filetto femmina: 1/2".

	06115501	83,00
	06115501NM	128,00
	06115501BM	128,00
	06115501AC	128,00
	06115501KM	128,00
	06115501KMB	128,00
	06115501OR	182,00
	06115501OM	182,00
	06115501OP	182,00
	06115501OPM	182,00

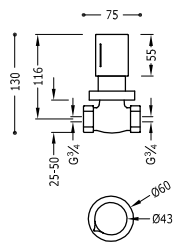

Concealed shut-off valve

Female thread connection: 3/4".

Valvola di intercettazione a incasso

Attacco a filetto femmina: 3/4".

	06151101	91,00
	06151101NM	140,00
	06151101BM	140,00
	06151101AC	140,00
	06151101KM	140,00
	06151101KMB	140,00
	06151101OR	199,00
	06151101OM	199,00
	06151101OP	199,00
	06151101OPM	199,00





CUADRO

A collection that cares for even the tiniest of details. With stylish lines, a compact body and modern design, the Cuadro series is pure craftsmanship, perfect for adding a distinguishing touch to the most cutting-edge spaces.

Una collezione attenta a ogni dettaglio. Con una linea sottile, un corpo compatto e un design moderno, la serie Cuadro è pura maestria per arredare gli spazi più all'avanguardia e offrire un tocco distinto.







WASHBASIN TAPS / RUBINETTI PER LAVABO

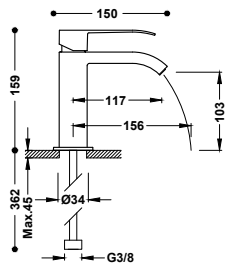

Single-handle washbasin mixer tap

Closed spout with cascade outlet. Flow limited to 5 l/min. G3/8 flexible hoses. Includes 2 regulation keys with filter (ref: 9134525).

Miscelatore monocomando per lavabo

Canna chiusa con getto a cascata. Flusso limitato a 5 l/min. Flessibili di alimentazione G3/8. Sono incluse 2 valvole di alimentazione con filtro (rif: 9134525).



00610101	163,00
00610101D	186,00
00610101NM	252,00
00610101BM	252,00
00610101AC	252,00
00610101OR	358,00
00610101OM	358,00
00610101NE	252,00
00610101BL	252,00

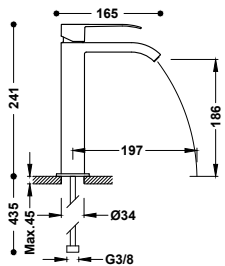

High single-handle washbasin mixer tap

Closed spout with cascade outlet. Flow limited to 5 l/min. G3/8 flexible hoses. Includes 2 regulation keys with filter (ref: 9134525).

Miscelatore monocomando alto per lavabo

Canna chiusa con getto a cascata. Flusso limitato a 5 l/min. Flessibili di alimentazione G3/8. Sono incluse 2 valvole di alimentazione con filtro (rif: 9134525).



00661001	313,00
00661001NM	485,00
00661001BM	485,00
00661001AC	485,00
00661001OR	688,00
00661001OM	688,00
00661001NE	485,00
00661001BL	485,00

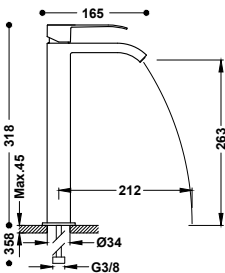

XXL single-handle washbasin mixer tap

Closed spout with cascade outlet. Flow limited to 5 l/min. G3/8 flexible hoses. Includes 2 regulation keys with filter (ref: 9134525).

Miscelatore monocomando XXL per lavabo

Canna chiusa con getto a cascata. Flusso limitato a 5 l/min. Flessibili di alimentazione G3/8. Sono incluse 2 valvole di alimentazione con filtro (rif: 9134525).



00681001	383,00
00681001NM	594,00
00681001BM	594,00
00681001AC	594,00
00681001OR	843,00
00681001OM	843,00
00681001NE	594,00
00681001BL	594,00

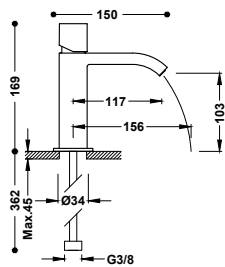

Single-handle washbasin mixer tap

Closed spout with cascade outlet. Flow limited to 5 l/min. G3/8 flexible hoses. Includes 2 regulation keys with filter (ref: 9134525).

Miscelatore monocomando per lavabo

Canna chiusa con getto a cascata. Flusso limitato a 5 l/min. Flessibili di alimentazione G3/8. Sono incluse 2 valvole di alimentazione con filtro (rif: 9134525).



00610102	163,00
00610102D	186,00

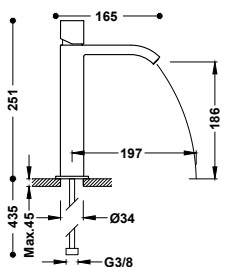

High single-handle washbasin mixer tap

Closed spout with cascade outlet. Flow limited to 5 l/min. G3/8 flexible hoses. Includes 2 regulation keys with filter (ref: 9134525).

Miscelatore monocomando alto per lavabo

Canna chiusa con getto a cascata. Flusso limitato a 5 l/min. Flessibili di alimentazione G3/8. Sono incluse 2 valvole di alimentazione con filtro (rif: 9134525).



00661002	313,00
----------	--------

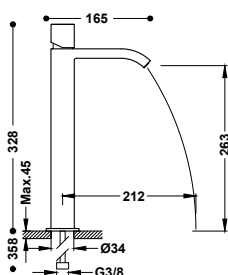

XXL single-handle washbasin mixer tap

Closed spout with cascade outlet. Flow limited to 5 l/min. G3/8 flexible hoses. Includes 2 regulation keys with filter (ref. 9134525).

Miscelatore monocomando XXL per lavabo

Canna chiusa con getto a cascata. Flusso limitato a 5 l/min. Flessibili di alimentazione G3/8. Sono incluse 2 valvole di alimentazione con filtro (rif. 9134525).



00681002 383,00

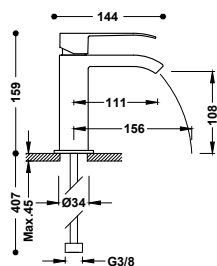

Single-handle washbasin mixer tap

Open spout with cascade outlet. G3/8 flexible hoses. Includes 2 regulation keys with filter (ref. 9134525).

Miscelatore monocomando per lavabo

Canna aperta con getto a cascata. Flessibili di alimentazione G3/8. Sono incluse 2 valvole di alimentazione con filtro (rif. 9134525).



00611001 278,00
 00611001D 301,00
 00611001NE 431,00
 00611001BL 431,00

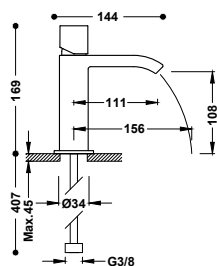

Single-handle washbasin mixer tap

Open spout with cascade outlet. G3/8 flexible hoses. Includes 2 regulation keys with filter (ref. 9134525).

Miscelatore monocomando per lavabo

Canna aperta con getto a cascata. Flessibili di alimentazione G3/8. Sono incluse 2 valvole di alimentazione con filtro (rif. 9134525).



00611002 278,00
 00611002D 301,00
 00611002NE 431,00
 00611002BL 431,00

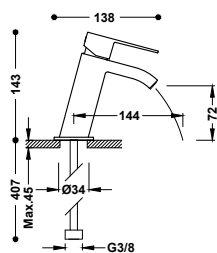

Inclined single-handle washbasin mixer tap

Closed spout with cascade outlet. Flow limited to 5 l/min. G3/8 flexible hoses. Includes 2 regulation keys with filter (ref. 9134525).

Miscelatore monocomando inclinato per lavabo

Canna chiusa con getto a cascata. Flusso limitato a 5 l/min. Flessibili di alimentazione G3/8. Sono incluse 2 valvole di alimentazione con filtro (rif. 9134525).



00620101 170,00
 00620101NM 264,00
 00620101BM 264,00
 00620101AC 264,00
 00620101OR 374,00
 00620101OM 374,00

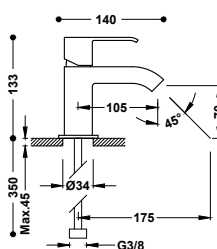

Single-handle washbasin mixer tap

G3/8 flexible hoses.

Miscelatore monocomando per lavabo

Flessibili di alimentazione G3/8.



106103 160,00
 106103DA 183,00

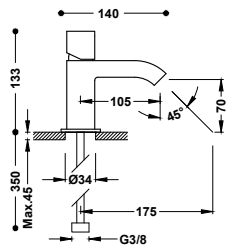

Single-handle washbasin mixer tap
G3/8 flexible hoses.

	107103	160,00
	107103DA	183,00

Miscelatore monocomando per lavabo
Flessibili di alimentazione G3/8.

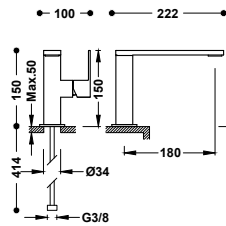

Single-handle washbasin mixer tap with lateral lever
G3/8 flexible hoses.

	10620501	263,00
	00620501NM	407,00
	00620501BM	407,00
	00620501AC	407,00
	00620501OR	578,00
	00620501OM	578,00

Miscelatore monocomando con leva laterale per lavabo
Flessibili di alimentazione G3/8.

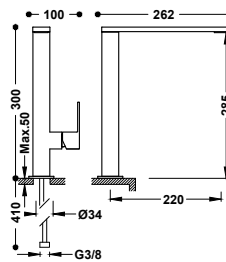

High single-handle washbasin mixer tap with lateral lever
G3/8 flexible hoses.

	00648501	305,00
	00648501NM	472,00
	00648501BM	472,00
	00648501AC	472,00
	00648501OR	670,00
	00648501OM	670,00

Miscelatore monocomando alto con leva laterale per lavabo
Flessibili di alimentazione G3/8.

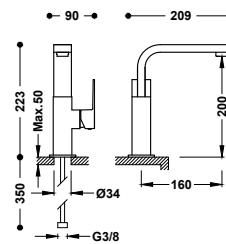

Single-handle washbasin mixer tap with lateral lever
G3/8 flexible hoses.

	106603	233,00
--	--------	--------

Miscelatore monocomando con leva laterale per lavabo
Flessibili di alimentazione G3/8.

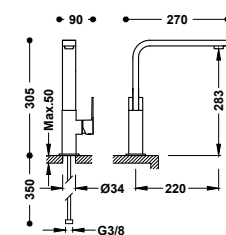

High single-handle washbasin mixer tap with lateral lever
G3/8 flexible hoses.

	106604	265,00
--	--------	--------

Miscelatore monocomando alto con leva laterale per lavabo
Flessibili di alimentazione G3/8.



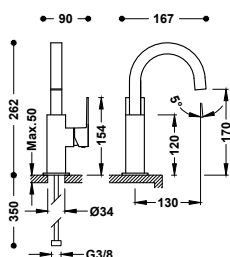

Single-handle washbasin mixer tap with lateral lever

G3/8 flexible hoses.

Miscelatore monocomando con leva laterale per lavabo

Flessibili di alimentazione G3/8.



106605	254,00
00660502NM	394,00
00660502BM	394,00
00660502AC	394,00
00660502OR	559,00
00660502OM	559,00

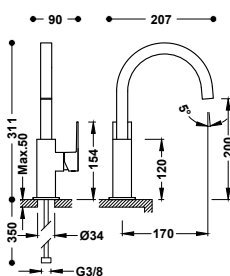

High single-handle washbasin mixer tap with lateral lever

G3/8 flexible hoses.

Miscelatore monocomando alto con leva laterale per lavabo

Flessibili di alimentazione G3/8.



106606	275,00
00660602NM	426,00
00660602BM	426,00
00660602AC	426,00
00660602OR	605,00
00660602OM	605,00

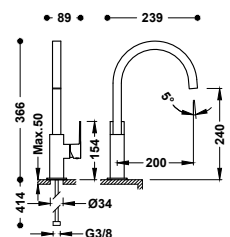

XXL single-handle washbasin mixer tap with lateral lever

G3/8 flexible hoses.

Miscelatore monocomando XXL con leva laterale per lavabo

Flessibili di alimentazione G3/8.



106607	286,00
00660702NM	443,00
00660702BM	443,00
00660702AC	443,00
00660702OR	628,00
00660702OM	628,00

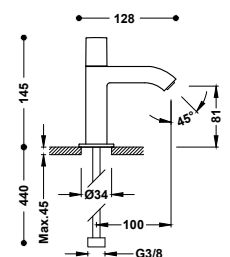

Washbasin tap with 1 water outlet

With G3/8 flexible shower hose.

Rubinetto monoacqua per lavabo

Con flessibili di alimentazione G3/8.



107503	158,00
00750301NM	244,00
00750301BM	244,00
00750301AC	244,00
00750301OR	347,00
00750301OM	347,00

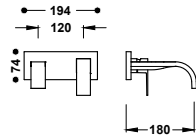

Visible part for recessed sink body

Visible part only. Includes concealing plate, handle and 180 mm spout. Recessed body not included.

Elemento a vista per il corpo a incasso da lavello

Solo parte a vista. Include piastra decorativa, comando e beccuccio da 180 mm. Corpo a incasso non incluso.

	00630031	190,00
	00630031NM	295,00
	00630031BM	295,00
	00630031AC	295,00
	00630031OR	418,00
	00630031OM	418,00



Recessed body for sink tap

20830002 85,00

Corpo a incasso per rubinetto da lavello

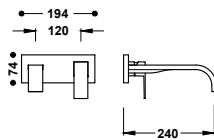

Visible part for recessed sink body

Visible part only. Includes concealing plate, handle and 240 mm spout. Recessed body not included.

Elemento a vista per il corpo a incasso da lavello

Solo parte a vista. Include piastra decorativa, comando e beccuccio da 240 mm. Corpo a incasso non incluso.

	00630032	200,00
	00630032NM	310,00
	00630032BM	310,00
	00630032AC	310,00
	00630032OR	440,00
	00630032OM	440,00



Recessed body for sink tap

20830002 85,00

Corpo a incasso per rubinetto da lavello

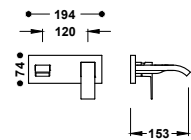

Visible part for recessed sink body

Visible part only. Includes concealing plate, handle and 153 mm spout. Recessed body not included.

Elemento a vista per il corpo a incasso da lavello

Solo parte a vista. Include piastra decorativa, comando e beccuccio da 153 mm. Corpo a incasso non incluso.

	00630033	240,00
	00630033NM	372,00
	00630033BM	372,00
	00630033AC	372,00
	00630033OR	528,00
	00630033OM	528,00



Recessed body for sink tap

20830002 85,00

Corpo a incasso per rubinetto da lavello

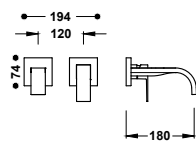

Visible part for recessed sink body

Visible part only. Includes concealing plate, handle and 180 mm spout. Recessed body not included.

Elemento a vista per il corpo a incasso da lavello

Solo parte a vista. Include piastra decorativa, comando e beccuccio da 180 mm. Corpo a incasso non incluso.

	00630021	157,00
	00630021NM	243,00
	00630021BM	243,00
	00630021AC	243,00
	00630021OR	345,00
	00630021OM	345,00



Recessed body for sink tap

20830002 85,00

Corpo a incasso per rubinetto da lavello

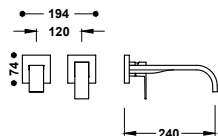

Visible part for recessed sink body

Visible part only. Includes concealing plate, handle and 240 mm spout. Recessed body not included.

Elemento a vista per il corpo a incasso da lavello

Solo parte a vista. Include piastra decorativa, comando e beccuccio da 240 mm. Corpo a incasso non incluso.

	00630022	167,00
	00630022NM	259,00
	00630022BM	259,00
	00630022AC	259,00
	00630022OR	367,00
	00630022OM	367,00



Recessed body for sink tap

20830002

85,00

Corpo a incasso per rubinetto da lavello

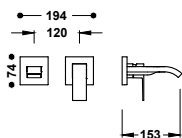

Visible part for recessed sink body

Visible part only. Includes concealing plate, handle and 153 mm spout. Recessed body not included.

Elemento a vista per il corpo a incasso da lavello

Solo parte a vista. Include piastra decorativa, comando e beccuccio da 153 mm. Corpo a incasso non incluso.

	00630023	210,00
	00630023NM	326,00
	00630023BM	326,00
	00630023AC	326,00
	00630023OR	462,00
	00630023OM	462,00



Recessed body for sink tap

20830002

85,00

Corpo a incasso per rubinetto da lavello

BIDET TAPS / RUBINETTI PER BIDET

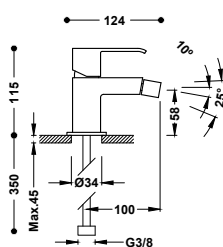

Single-handle bidet mixer tap

Adjustable shower head. G3/8 flexible hoses.

Miscelatore monocomando per bidet

Supporto orientabile. Flessibili di alimentazione G3/8.



	00612001	166,00
	00612001D	189,00
	00612001NM	257,00
	00612001BM	257,00
	00612001AC	257,00
	00612001OR	365,00
	00612001OM	365,00
	00612001NE	257,00
	00612001BL	257,00

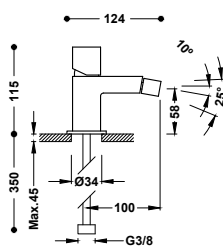

Single-handle bidet mixer tap

Adjustable shower head. G3/8 flexible hoses.

Miscelatore monocomando per bidet

Supporto orientabile. Flessibili di alimentazione G3/8.



	00712001	166,00
	00712001D	189,00
	00712001NM	257,00
	00712001BM	257,00
	00712001AC	257,00
	00712001OR	365,00
	00712001OM	365,00
	00712001NE	257,00
	00712001BL	257,00

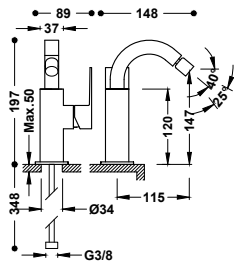

Single-handle bidet mixer tap with lateral lever

Adjustable shower head. G3/8 flexible hoses.

Miscelatore monocomando con leva laterale per bidet

Supporto orientabile. Flessibili di alimentazione G3/8.



■ 106124	233,00
■ 00612402NM	361,00
■ 00612402BM	361,00
■ 00612402AC	361,00
■ 00612402OR	513,00
■ 00612402OM	513,00

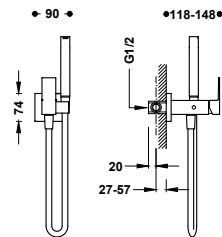

Concealed single lever WC/ bidet mixer

With cold and hot water. Hand shower with 5 l/min limiter coupling and non-drip system. Fixed support for hand shower for installation on right or left. Satin hose.

Miscelatore monocomando con doccino per wc

Con acqua fredda e calda. Doccino con limitatore a 5 l/min. e sistema antigocciolamento. Supporto fisso per doccino installabile a destra o a sinistra. Flessibile satinato.



■ 00612301	200,00
■ 00612301NM	310,00
■ 00612301BM	310,00
■ 00612301AC	310,00
■ 00612301OR	440,00
■ 00612301OM	440,00

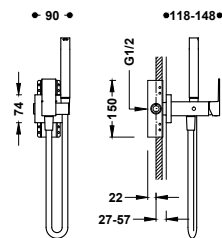

Concealed single lever WC/ bidet mixer

Option for plasterboard walls. With cold and hot water. Hand shower with 5 l/min limiter coupling and non-drip system. Fixed support for hand shower for installation on right or left. Satin hose.

Miscelatore monocomando con doccino per wc

Opzione per pareti in cartongesso. Con acqua fredda e calda. Doccino con limitatore a 5 l/min. e sistema antigocciolamento. Supporto fisso per doccino installabile a destra o a sinistra. Flessibile satinato.



■ 00612302	240,00
■ 00612302NM	372,00
■ 00612302BM	372,00
■ 00612302AC	372,00



Towel holder accessory for toilet mixer tap with shower

Installable support for right or left side (for ref.: 00612301, 00612302). Length: 180 mm.

Portasciugamano per rubinetto con doccino per wc

Supporto installabile a destra o a sinistra (per rif.: 00612301, 00612302). Lungh.: 180 mm.

■ 03412402	47,00
■ 03412402NM	73,00
■ 03412402BM	73,00
■ 03412402AC	73,00
■ 03412402OR	104,00
■ 03412402OM	104,00

WALL TAPS / RUBINETTI A MURO

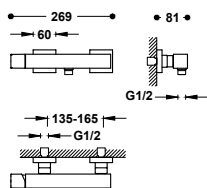

Wall-mounted single-handle shower mixer tap

Anti-limescale brass hand shower. Adjustable support for hand shower. Satin hose.

Miscelatore monocomando a muro per doccia

Doccino anticalcare in ottone. Supporto orientabile per doccino. Flessibile satinato.

107167	313,00
00716703NM	485,00
00716703BM	485,00
50716703	485,00
00716703OR	688,00
00716703OM	688,00

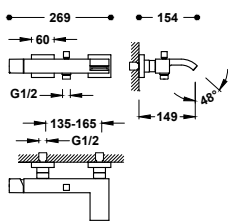

Wall-mounted single-handle mixer tap for bath and shower

With cascade outlet. Anti-limescale brass hand shower. Adjustable support for hand shower. Satin hose.

Miscelatore monocomando a muro per vasca e doccia

Con getto a cascata. Doccino anticalcare in ottone. Supporto orientabile per doccino. Flessibile satinato.

10717002	334,00
0071700203NM	518,00
0071700203BM	518,00
5071700203	518,00
0071700203OR	735,00
0071700203OM	735,00

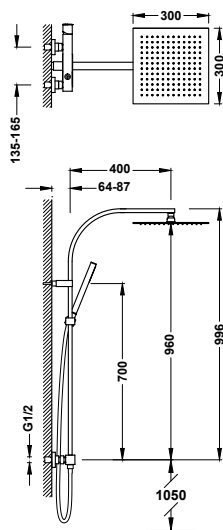

2-way wall-fitted single-handle shower mixer tap

- Stainless steel adjustable shower head: 300x300 mm.
- Adjustable and sliding support for hand shower.
- Anti-limescale brass hand shower.
- Satin hose.

Set miscelatore monocomando a muro 2 getti per doccia

- Soffione doccia orientabile in acciaio inossidabile: 300x300 mm.
- Supporto scorrevole e orientabile per doccino.
- Doccino anticalcare in ottone.
- Flessibile satinato.

00719102	680,00
----------	--------



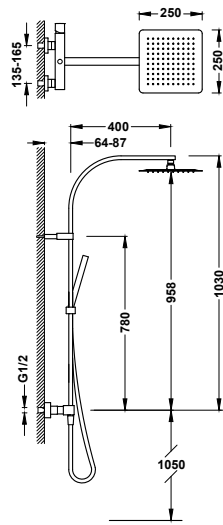

2-way wall-fitted single-handle shower mixer tap

00719101

635,00

- Stainless steel adjustable shower head: 250x250 mm.
- Adjustable and sliding support for hand shower.
- Anti-limescale brass hand shower.
- Satin hose.

Set miscelatore monocomando a muro 2 getti per doccia

- Soffione doccia orientabile in acciaio inossidabile: 250x250 mm.
- Supporto scorrevole e orientabile per doccia.
- Doccino anticalcare in ottone.
- Flessibile satinato.

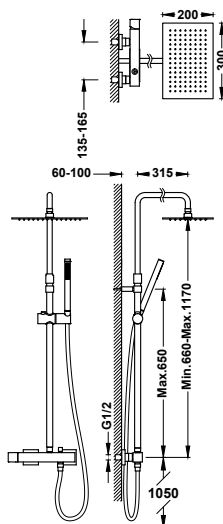

2-way wall-fitted single-handle shower mixer tap

00719702

626,00

- Stainless steel adjustable shower head: 300x200 mm.
- Telescopic shower bar.
- Adjustable and sliding support for hand shower.
- Anti-limescale brass hand shower.
- Satin hose.

Set miscelatore monocomando a muro 2 getti per doccia

- Soffione doccia orientabile in acciaio inossidabile: 300x200 mm.
- Colonna doccia telescopica.
- Supporto scorrevole e orientabile per doccia.
- Doccino anticalcare in ottone.
- Flessibile satinato.

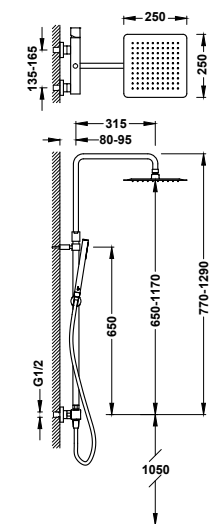

2-way wall-fitted single-handle shower mixer tap

00719701

582,00

- Stainless steel adjustable shower head: 250x250 mm.
- Telescopic shower bar.
- Adjustable and sliding support for hand shower.
- Anti-limescale brass hand shower.
- Satin hose.

Set miscelatore monocomando a muro 2 getti per doccia

- Soffione doccia orientabile in acciaio inossidabile: 250x250 mm.
- Colonna doccia telescopica.
- Supporto scorrevole e orientabile per doccia.
- Doccino anticalcare in ottone.
- Flessibile satinato.



CONCEALED TAPS/ RUBINETTI DA INCASSO

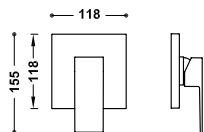

Visible part for concealed 1-way Rapid-box

Only visible part. Includes trim plate, control, bush and concealed attachment screw. Complete with concealed Rapid-box ref.: 20827810.

Pezzo vista per cassa da incasso a 1 via Rapid-box

Solo parte vista. Include piastra decorativa, comando, boccola e vite di fissaggio occulta. Completare con scatola da incasso Rapid-box rif.: 20827810.

10627810	89,00
10627810NM	138,00
10627810BM	138,00
10627810AC	138,00
10627810OR	196,00
10627810OM	196,00



Concealed 1-way Rapid-box with single-handle mixer tap for shower

20827810 80,00

Scatola da incasso a 1 via Rapid-box con miscelatore monocomando per doccia

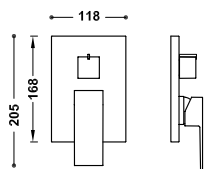

Visible part for concealed 2-way Rapid-box

Only visible part. Includes trim plate, control, distribution handle and concealed attachment screw. Complete with concealed Rapid-box ref.: 20828110.

Pezzo vista per cassa da incasso a 2 vie Rapid-box

Solo parte vista. Include piastra decorativa, comando, volante distributore e vite di fissaggio occulta. Completare con scatola da incasso Rapid-box rif.: 20828110.

10628110	116,00
10628110NM	179,00
10628110BM	179,00
10628110AC	179,00
10628110OR	254,00
10628110OM	254,00



Concealed 2-way Rapid-box with single-handle mixer tap for shower and bath

20828110 90,00

Scatola da incasso a 2 vie Rapid-box con miscelatore monocomando per doccia e vasca da bagno

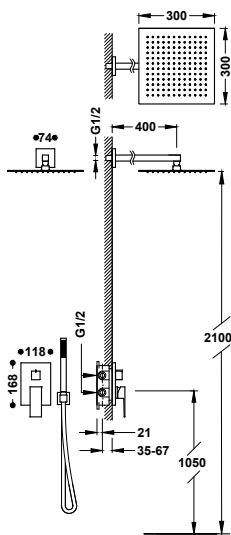

Rapid-box 2-way concealed single-handle shower mixer tap kit

- Concealed body included.
- 2-way ceramic distributor.
- Wall-mounted arm with adjustable stainless steel shower head: 300x300 mm.
- Wall-mounted support for hand shower with water supply.
- Anti-limescale brass hand shower.
- Satin hose.

Kit di miscelatore monocomando a incasso 2 getti Rapid-box per doccia

- Corpo a incasso incluso.
- Erogatore in ceramica a 2 getti.
- Braccio a muro con soffione doccia orientabile in acciaio inossidabile: 300x300 mm.
- Supporto per doccia con presa d'acqua a muro.
- Doccino anticalcare in ottone.
- Flessibile satinato.

00628004	582,00
00628004NM	853,00
00628004BM	853,00
00628004AC	853,00
00628004OR	1.174,00
00628004OM	1.174,00



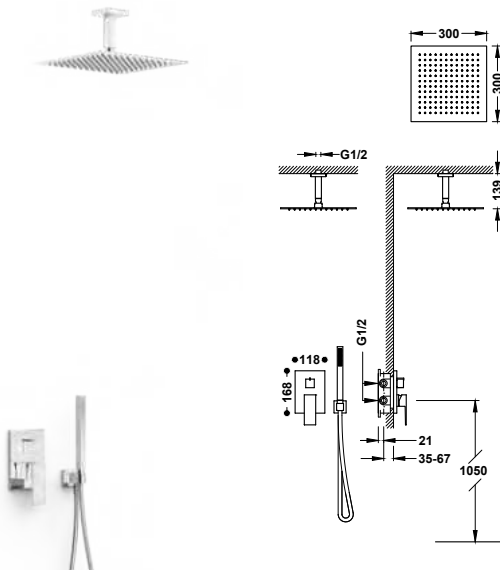

Rapid-box 2-way concealed single-handle shower mixer tap kit

- Concealed body included.
- 2-way ceramic distributor.
- Ceiling-mounted arm with adjustable stainless steel shower head: 300x300 mm.
- Wall-mounted support for hand shower with water supply.
- Anti-limescale brass hand shower.
- Satin hose.

00628003	559,00
00628003NM	818,00
00628003BM	818,00
00628003AC	818,00
00628003OR	1.125,00
00628003OM	1.125,00

Kit di miscelatore monocomando a incasso 2 getti Rapid-box per doccia

- Corpo a incasso incluso.
- Erogatore in ceramica a 2 getti.
- Braccio a soffitto con soffione doccia orientabile in acciaio inossidabile: 300x300 mm.
- Supporto per doccia con presa d'acqua a muro.
- Doccino anticalcare in ottone.
- Flessibile satinato.

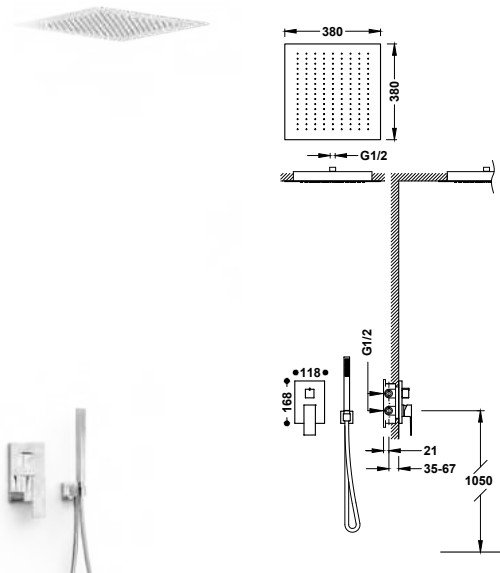

Rapid-box 2-way concealed single-handle shower mixer tap kit

- Concealed body included.
- 2-way ceramic distributor.
- Concealed stainless steel ceiling-mounted shower head: 380x380 mm.
- Wall-mounted support for hand shower with water supply.
- Anti-limescale brass hand shower.
- Satin hose.

00628005	1.097,00
00628005NM	1.654,00
00628005BM	1.654,00
00628005AC	1.654,00
00628005OR	2.312,00
00628005OM	2.312,00

Kit di miscelatore monocomando a incasso 2 getti Rapid-box per doccia

- Corpo a incasso incluso.
- Erogatore in ceramica a 2 getti.
- Soffione doccia soffitto a incasso in acciaio inossidabile: 380x380 mm.
- Supporto per doccia con presa d'acqua a muro.
- Doccino anticalcare in ottone.
- Flessibile satinato.

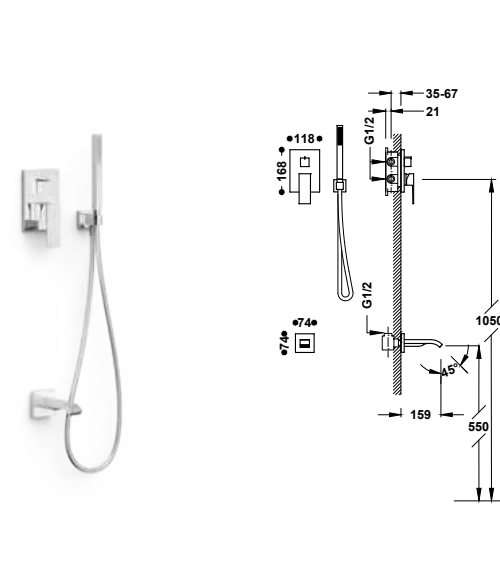

Rapid-box 2-way concealed single-handle mixer tap kit for bath and shower

- Concealed body included.
- 2-way ceramic distributor.
- Fixed wall-mounted spout.
- Wall-mounted support for hand shower with water supply.
- Anti-limescale brass hand shower.
- Satin hose.

00628006	459,00
00628006NM	662,00
00628006BM	662,00
00628006AC	662,00
00628006OR	903,00
00628006OM	903,00

Kit di miscelatore monocomando a incasso a 2 getti Rapid-box per vasca e doccia

- Corpo a incasso incluso.
- Erogatore in ceramica a 2 getti.
- Canna fissa a muro.
- Supporto per doccia con presa d'acqua a muro.
- Doccino anticalcare in ottone.
- Flessibile satinato.

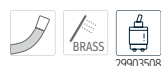

1-way concealed single-handle shower mixer tap

106177

126,00

Concealed body included.

Miscelatore monocomando a incasso 1 getto per doccia

Corpo a incasso incluso.

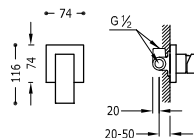

Extender for 1-way concealed single-handle shower mixer tap

10617710

95,00

Prolunga per miscelatore monocomando a incasso 1 getto per doccia



2-way concealed single-handle shower mixer tap

106180

210,00

Concealed body included. 2-way diverter.

Miscelatore monocomando a incasso 2 getti per doccia

Corpo a incasso incluso. Inverter a 2 getti.

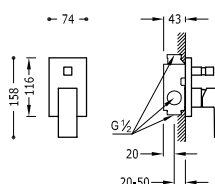

Extension set for 2-way concealed single-handle mixer taps

10618010

105,00

Set di estensione per miscelatori monocomando a incasso 2 getti



2-way concealed single-handle shower mixer tap kit

00698003

582,00

- Concealed body included.
- 2-way diverter.
- Wall-mounted arm with adjustable stainless steel shower head: 300x200 mm.
- Wall-mounted support for hand shower with water supply.
- Anti-limescale brass hand shower.
- Satin hose.

Kit di miscelatore monocomando a incasso 2 getti per doccia

- Corpo a incasso incluso.
- Inverter a 2 getti.
- Braccio a muro con soffione doccia orientabile in acciaio inossidabile: 300x200mm.
- Supporto per doccino con presa d'acqua a muro.
- Doccino anticalcare in ottone.
- Flessibile satinato.

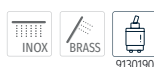
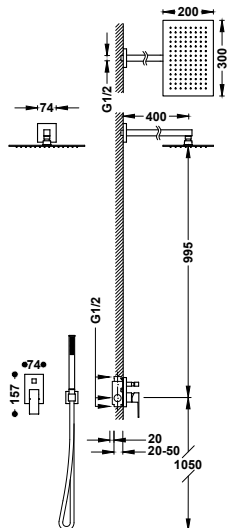

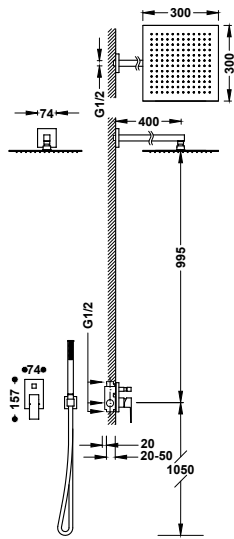

2-way concealed single-handle shower mixer tap kit

106980

561,00

- Concealed body included.
- 2-way diverter.
- Wall-mounted arm with adjustable stainless steel shower head: 300x300 mm.
- Wall-mounted support for hand shower with water supply.
- Anti-limescale brass hand shower.
- Satin hose.

Kit di miscelatore monocomando a incasso 2 getti per doccia

- Corpo a incasso incluso.
- Inverter a 2 getti.
- Braccio a muro con soffione doccia orientabile in acciaio inossidabile: 300x300mm.
- Supporto per doccia con presa d'acqua a muro.
- Doccino anticalcare in ottone.
- Flessibile satinato.

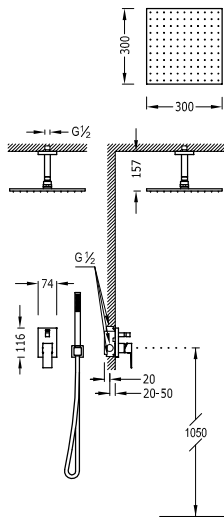

2-way concealed single-handle shower mixer tap kit

00618080

550,00

- Concealed body included.
- 2-way diverter.
- Ceiling-mounted arm with adjustable stainless steel shower head: 300x300 mm.
- Wall-mounted support for hand shower with water supply.
- Anti-limescale brass hand shower.
- Satin hose.

Kit di miscelatore monocomando a incasso 2 getti per doccia

- Corpo a incasso incluso.
- Inverter a 2 getti.
- Braccio a soffitto con soffione doccia orientabile in acciaio inossidabile: 300x300mm.
- Supporto per doccia con presa d'acqua a muro.
- Doccino anticalcare in ottone.
- Flessibile satinato.

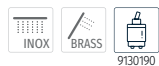

BATH TAPS / RUBINETTI PER VASCA

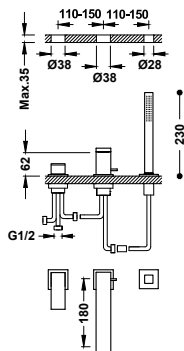

Single-handle bath edge mixer tap

00616105

462,00

- Inverter integrated into the bath spout.
- Anti-limescale brass hand shower.
- 180 mm bath spout. Water flow: 3 bar - 13 l/min.
- Optional tank kit not included ref: 20024501.

Miscelatore monocomando bordo vasca

- Inverter incorporato nella canna della vasca.
- Doccino anticalcare in ottone.
- Canna della vasca di 180 mm. Flusso: 3 bar - 13 l/m.
- Kit contenitore opzionale non incluso rif: 20024501.

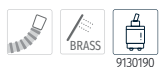

00616105NM

716,00

00616105BM

716,00

00616105AC

716,00

00616105OR

1.016,00

00616105OM

1.016,00



Tank for bath edge tapware

20024501

415,00

Contenitore per kit di miscelazione bordo vasca



Click-clack drainage valve for bath with overflow and drainage point

134445

100,00

Valvola di scarico Click-clack per vasca con troppopieno e presa drenaggio

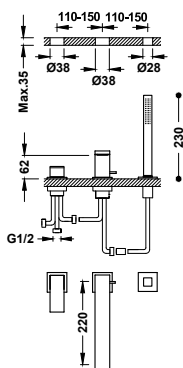

Single-handle bath edge mixer tap

- Inverter integrated into the bath spout.
- Anti-limescale brass hand shower.
- 220 mm bath spout. Water flow: 3 bar - 13 l/min.
- Optional tank kit not included ref: 20024501.

Miscelatore monocomando bordo vasca

- Inverter incorporato nella canna della vasca.
- Doccino anticalcare in ottone.
- Canna della vasca di 220 mm. Flusso: 3 bar - 13 l/m.
- Kit contenitore opzionale non incluso rif: 20024501.

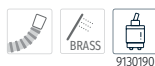

	00616103	410,00
	00616103NM	636,00
	00616103BM	636,00
	00616103AC	636,00
	00616103OR	902,00
	00616103OM	902,00



Tank for bath edge tapware
 Contenitore per kit di miscelazione bordo vasca

	20024501	415,00
--	----------	--------

→406



Click-clack drainage valve for bath with overflow and drainage point
 Valvola di scarico Click-clack per vasca con troppopieno e presa drenaggio

	134445	100,00
--	--------	--------

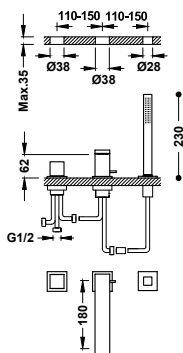

Single-handle bath edge mixer tap

- Inverter integrated into the bath spout.
- Anti-limescale brass hand shower.
- 180 mm bath spout. Water flow: 3 bar - 13 l/min.
- Optional tank kit not included ref: 20024501.

Miscelatore monocomando bordo vasca

- Inverter incorporato nella canna della vasca.
- Doccino anticalcare in ottone.
- Canna della vasca di 180 mm. Flusso: 3 bar - 13 l/m.
- Kit contenitore opzionale non incluso rif: 20024501.

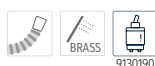

	00616106	400,00
--	----------	--------



Tank for bath edge tapware
 Contenitore per kit di miscelazione bordo vasca

	20024501	415,00
--	----------	--------



Click-clack drainage valve for bath with overflow and drainage point
 Valvola di scarico Click-clack per vasca con troppopieno e presa drenaggio

	134445	100,00
--	--------	--------

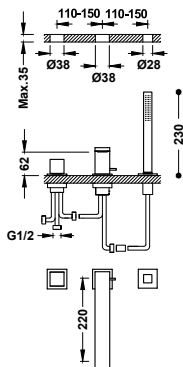

Single-handle bath edge mixer tap

- Inverter integrated into the bath spout.
- Anti-limescale brass hand shower.
- 220 mm bath spout. Water flow: 3 bar - 13 l/min.
- Optional tank kit not included ref: 20024501.

Miscelatore monocomando bordo vasca

- Inverter incorporato nella canna della vasca.
- Doccino anticalcare in ottone.
- Canna della vasca di 220 mm. Flusso: 3 bar - 13 l/m.
- Kit contenitore opzionale non incluso rif: 20024501.

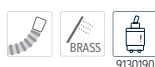

	00616104	473,00
--	----------	--------



Tank for bath edge tapware
 Contenitore per kit di miscelazione bordo vasca

	20024501	415,00
--	----------	--------



Click-clack drainage valve for bath with overflow and drainage point
 Valvola di scarico Click-clack per vasca con troppopieno e presa drenaggio

	134445	100,00
--	--------	--------

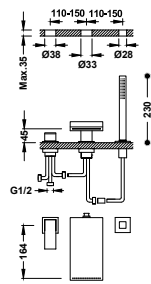

Single-handle bath edge mixer tap

10616102 890,00

- Inverter integrated into the bath spout.
- Anti-limescale brass hand shower.
- Bath spout with cascade outlet: 164 mm. Water flow: 3 bar - 13 l/min.
- Optional tank kit not included ref.: 106245.

Miscelatore monocomando bordo vasca

- Inverter incorporato nella canna della vasca.
- Doccino anticalcare in ottone.
- Canna della vasca con getto a cascata: 164 mm. Flusso: 3 bar - 13 l/min.
- Kit contenitore opzionale non incluso rif: 106245.

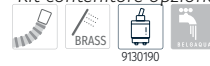

Tank for bath edge tapware
Contenitore per kit di miscelazione bordo vasca

106245 415,00



Click-clack drainage valve for bath with overflow and drainage point
Valvola di scarico Click-clack per vasca con troppopieno e presa drenaggio

134445 100,00

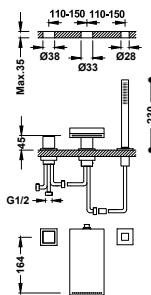

Single-handle bath edge mixer tap

10716102 880,00

- Inverter integrated into the bath spout.
- Anti-limescale brass hand shower.
- Bath spout with cascade outlet: 161 mm. Water flow: 3 bar - 13 l/min.
- Optional tank kit not included ref.: 106245.

Miscelatore monocomando bordo vasca

- Inverter incorporato nella canna della vasca.
- Doccino anticalcare in ottone.
- Canna della vasca con getto a cascata: 161 mm. Flusso: 3 bar - 13 l/min.
- Kit contenitore opzionale non incluso rif: 106245.

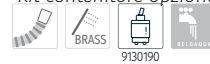

Tank for bath edge tapware
Contenitore per kit di miscelazione bordo vasca

106245 415,00



Click-clack drainage valve for bath with overflow and drainage point
Valvola di scarico Click-clack per vasca con troppopieno e presa drenaggio

134445 100,00

THERMOSTATIC WALL TAPS / RUBINETTO TERMOSTATICI A MURO

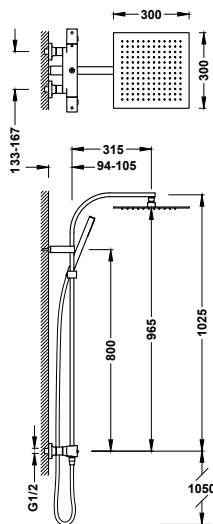

2-way Over-wall thermostatic shower mixer tap set

19039308 620,00

- With diverter integrated into the flow regulator.
- Square handle.
- Stainless steel adjustable shower head: 300x300 mm.
- Adjustable and sliding support for hand shower.
- Anti-limescale brass hand shower.
- Satin hose.

19039308NM 961,00

19039308BM 961,00

19039308AC 961,00

19039308OM 1.364,00

Set di miscelatore termostatico a muro Over-wall 2 getti per doccia

- Con inverter incorporato nel regolatore di flusso.
- Manopola quadrata.
- Soffione doccia orientabile in acciaio inossidabile: 300x300 mm.
- Supporto scorrevole e orientabile per doccia.
- Doccino anticalcare in ottone.
- Flessibile satinato.



THERMOSTATIC CONCEALED TAPS / RUBINETTI TERMOSTATICI DA INCASSO

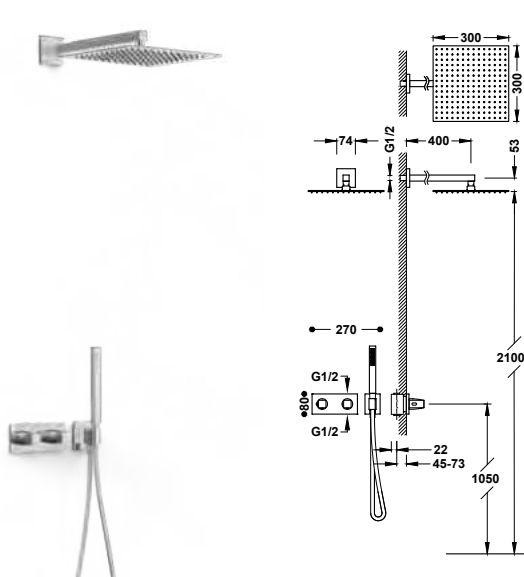

B-system 2-way concealed thermostatic shower mixer tap kit

- Concealed thermostatic body for horizontal installation included.
- Flow regulator and 2-way ceramic distributor.
- Square-round handle.
- Wall-mounted arm with adjustable brass shower head: 300x300 mm.
- Wall-mounted support for hand shower with water supply.
- Anti-limescale brass hand shower.
- Satin hose.

Kit di miscelatore termostatico a incasso 2 getti B-system per doccia

- Corpo termostatico a incasso con installazione orizzontale inclusa.
- Regolatore di flusso ed erogatore in ceramica a 2 getti.
- Manopola quadrata-rotonda.
- Braccio a muro con soffione doccia orientabile in acciaio inossidabile: 300x300 mm.
- Supporto per doccia con presa d'acqua a muro.
- Doccino anticalcare in ottone.
- Flessibile satinato.



	30725204	782,00
	30725204NM	1.210,00
	30725204AC	1.210,00
	30725204OR	1.718,00
	30725204OM	1.718,00

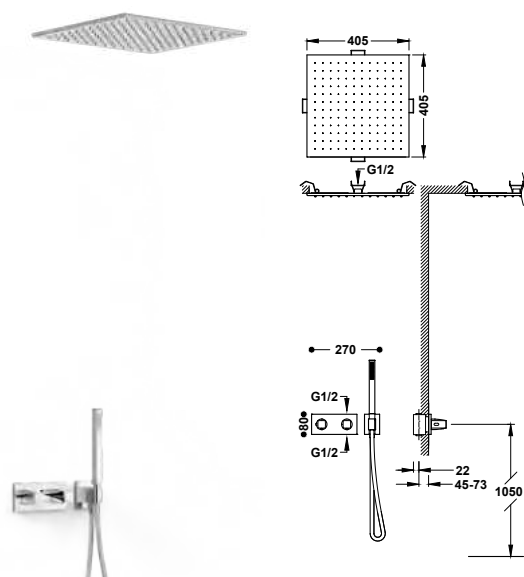

B-system 2-way concealed thermostatic shower mixer tap kit

- Concealed thermostatic body for horizontal installation included.
- Flow regulator and 2-way ceramic distributor.
- Square-round handle.
- Concealed stainless steel ceiling-mounted shower head: 405x405 mm.
- Wall-mounted support for hand shower with water supply.
- Anti-limescale brass hand shower.
- Satin hose.

Kit di miscelatore termostatico a incasso 2 getti B-system per doccia

- Corpo termostatico a incasso con installazione orizzontale inclusa.
- Regolatore di flusso ed erogatore in ceramica a 2 getti.
- Manopola quadrata-rotonda.
- Soffione doccia soffitto a incasso in acciaio inossidabile: 405x405 mm.
- Supporto per doccia con presa d'acqua a muro.
- Doccino anticalcare in ottone.
- Flessibile satinato.



	30725206	1.315,00
	30725206NM	1.855,00
	30725206AC	1.855,00
	30725206OR	2.895,00
	30725206OM	2.895,00

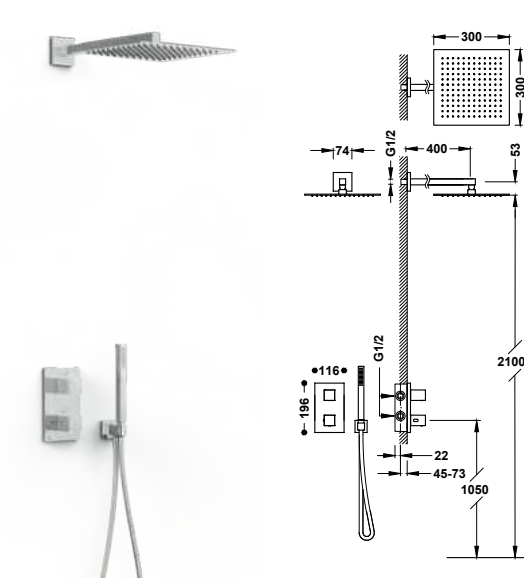

Therm-box 2-way concealed thermostatic tap kit for showers

- Concealed body included.
- Square handle with temperature control. 2-way ceramic distributor.
- Wall-mounted arm with adjustable stainless steel shower head: 300x300 mm.
- Wall-mounted support for hand shower with water supply.
- Anti-limescale brass hand shower.
- Satin hose.

Kit di miscelatore termostatico da incasso a 2 getti Therm-box per doccia

- Corpo a incasso incluso.
- Manopola quadrata con controllo della temperatura. Erogatore in ceramica a 2 getti.
- Braccio a muro con soffione doccia orientabile in acciaio inossidabile: 300x300 mm.
- Supporto per doccia con presa d'acqua a muro.
- Doccino anticalcare in ottone.
- Flessibile satinato.



	00625004	641,00
	00625004NM	922,00
	00625004BM	922,00
	00625004AC	922,00
	00625004OR	1.256,00
	00625004OM	1.256,00

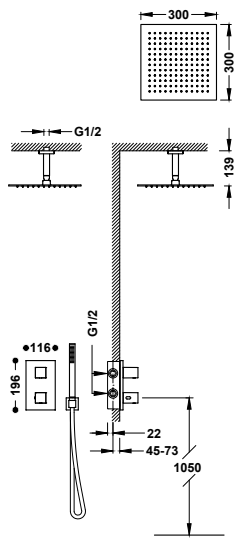

Therm-box 2-way concealed thermostatic tap kit for showers

- Concealed body included.
- Square handle with temperature control. 2-way ceramic distributor.
- Ceiling-mounted arm with adjustable stainless steel shower head: 300x300 mm.
- Wall-mounted support for hand shower with water supply.
- Anti-limescale brass hand shower.
- Satin hose.

00625003	620,00
00625003NM	888,00
00625003BM	888,00
00625003AC	888,00
00625003OR	1.207,00
00625003OM	1.207,00

**Kit di miscelatore termostatico da incasso a 2 getti
Therm-box per doccia**

- Corpo a incasso incluso.
- Manopola quadrata con controllo della temperatura. Erogatore in ceramica a 2 getti.
- Braccio a soffitto con soffione doccia orientabile in acciaio inossidabile: 300x300 mm.
- Supporto per doccia con presa d'acqua a muro.
- Doccino anticalcare in ottone.
- Flessibile satinato.



SHUT-OFF VALVES / VALVOLE DI INTERCETTAZIONE

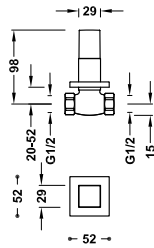

Concealed shut-off valve

Female thread connection: 1/2".

Valvola di intercettazione a incasso

Attacco a filetto femmina: 1/2".

00715501	89,00
00715501NM	137,00
00715501BM	137,00
00715501AC	137,00
00715501OR	196,00
00715501OM	196,00

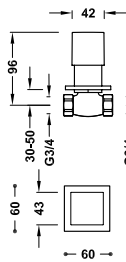

Concealed shut-off valve

Female thread connection: 3/4".

Valvola di intercettazione a incasso

Attacco a filetto femmina: 3/4".

107511	96,00
--------	-------



LOFT

The balance between flat and rounded surfaces results in a wide and versatile collection. Loft is the series which best fits in to any situation and is always a winning choice. Designed for water.

L'equilibrio tra superfici piane e arrotondate si traduce in una collezione molto ampia e versatile. Loft è la serie che meglio si adatta e colpisce sempre nel segno. Progettata per l'acqua.





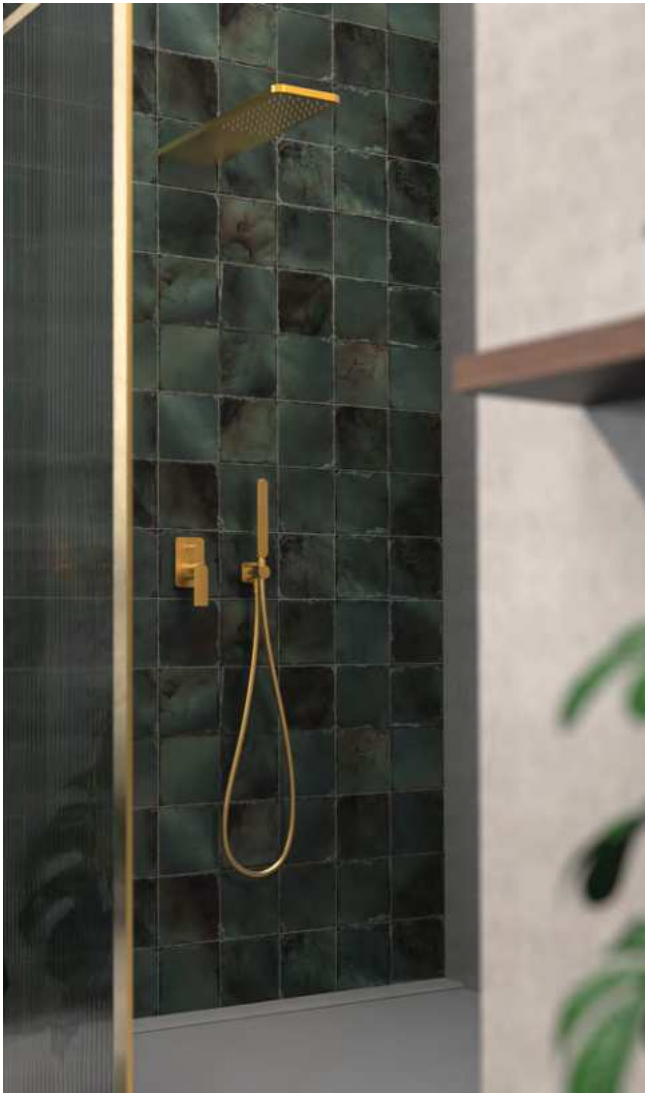

WASHBASIN TAPS / RUBINETTI PER LAVABO

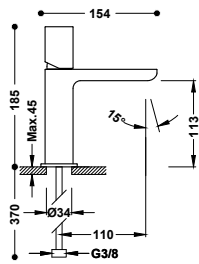

Single-handle washbasin mixer tap

G3/8 flexible hoses.

Miscelatore monocomando per lavabo

Flessibili di alimentazione G3/8.

20010302	131,00
20010302D	154,00
20010302NM	203,00
20010302BM	203,00
20010302AC	203,00
20010302OR	289,00
20010302OM	289,00
20010302NE	203,00
20010302BL	203,00

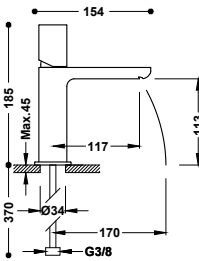

Single-handle washbasin mixer tap

Closed spout with cascade outlet. G3/8 flexible hoses. Includes 2 regulation keys with filter (ref: 9134525).

Miscelatore monocomando per lavabo

Canna chiusa con getto a cascata. Flessibili di alimentazione G3/8. Sono incluse 2 valvole di alimentazione con filtro (rif: 9134525).

20010102	158,00
20010102D	181,00

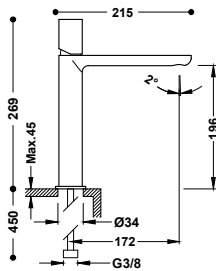

High single-handle washbasin mixer tap

G3/8 flexible hoses.

Miscelatore monocomando alto per lavabo

Flessibili di alimentazione G3/8.

20020304	244,00
20020304NM	378,00
20020304BM	378,00
20020304AC	378,00
20020304OR	536,00
20020304OM	536,00
20020304NE	378,00
20020304BL	378,00

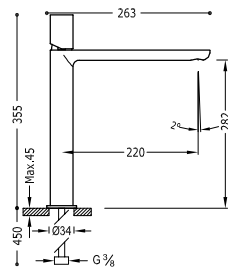

XXL single-handle washbasin mixer tap

G3/8 flexible hoses.

Miscelatore monocomando XXL per lavabo

Flessibili di alimentazione G3/8.

20020306	278,00
20020306NM	431,00
20020306BM	431,00
20020306AC	431,00
20020306OR	612,00
20020306OM	612,00
20020306NE	431,00
20020306BL	431,00

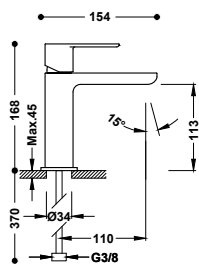

Single-handle washbasin mixer tap

G3/8 flexible hoses.

Miscelatore monocomando per lavabo

Flessibili di alimentazione G3/8.

20010301	131,00
20010301D	154,00
20010301NM	203,00
20010301BM	203,00
20010301AC	203,00
20010301OR	289,00
20010301OM	289,00
20010301NE	203,00
20010301BL	203,00

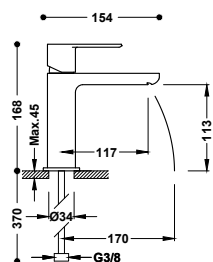

Single-handle washbasin mixer tap

Closed spout with cascade outlet. G3/8 flexible hoses. Includes 2 regulation keys with filter (ref: 9134525).

Miscelatore monocomando per lavabo

Canna chiusa con getto a cascata. Flessibili di alimentazione G3/8. Sono incluse 2 valvole di alimentazione con filtro (rif: 9134525).



- 20010101 158,00
- 20010101D 181,00

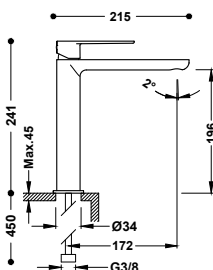

High single-handle washbasin mixer tap

G3/8 flexible hoses.

Miscelatore monocomando alto per lavabo

Flessibili di alimentazione G3/8.



- 20020303 244,00
- 20020303NM 378,00
- 20020303BM 378,00
- 20020303AC 378,00
- 20020303OR 536,00
- 20020303OM 536,00
- 20020303NE 378,00
- 20020303BL 378,00

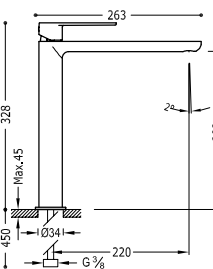

XXL single-handle washbasin mixer tap

G3/8 flexible hoses.

Miscelatore monocomando XXL per lavabo

Flessibili di alimentazione G3/8.



- 20020305 278,00
- 20020305NM 431,00
- 20020305BM 431,00
- 20020305AC 431,00
- 20020305OR 612,00
- 20020305OM 612,00
- 20020305NE 431,00
- 20020305BL 431,00

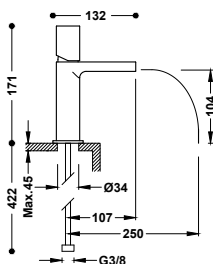

Single-handle washbasin mixer tap

Open spout with cascade outlet. G3/8 flexible hoses. Includes 2 regulation keys with filter (ref: 9134525).

Miscelatore monocomando per lavabo

Canna aperta con getto a cascata. Flessibili di alimentazione G3/8. Sono incluse 2 valvole di alimentazione con filtro (rif: 9134525).



- 20011002 223,00
- 20011002NE 345,00
- 20011002BL 345,00

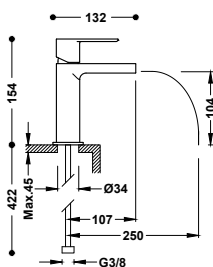

Single-handle washbasin mixer tap

Open spout with cascade outlet. G3/8 flexible hoses. Includes 2 regulation keys with filter (ref: 9134525).

Miscelatore monocomando per lavabo

Canna aperta con getto a cascata. Flessibili di alimentazione G3/8. Sono incluse 2 valvole di alimentazione con filtro (rif: 9134525).



- 20011001 223,00
- 20011001NE 345,00
- 20011001BL 345,00

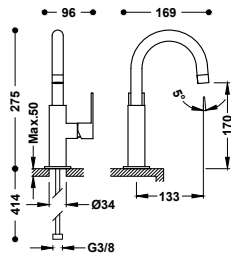

Single-handle washbasin mixer tap with lateral lever
G3/8 flexible hoses.

Miscelatore monocomando con leva laterale per lavabo
Flessibili di alimentazione G3/8.



20020504	210,00
20020504NM	326,00
20020504BM	326,00
20020504AC	326,00
20020504OR	462,00
20020504OM	462,00
20020504NE	326,00
20020504BL	326,00

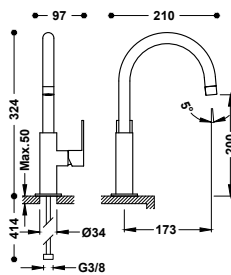

High single-handle washbasin mixer tap with lateral lever
G3/8 flexible hoses.

Miscelatore monocomando alto con leva laterale per lavabo
Flessibili di alimentazione G3/8.



20020505	221,00
20020505NM	342,00
20020505BM	342,00
20020505AC	342,00
20020505OR	485,00
20020505OM	485,00
20020505NE	342,00
20020505BL	342,00

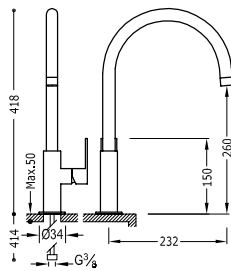

XXL single-handle washbasin mixer tap with lateral lever
G3/8 flexible hoses.

Miscelatore monocomando XXL con leva laterale per lavabo
Flessibili di alimentazione G3/8.



20020506	231,00
20020506NM	358,00
20020506BM	358,00
20020506AC	358,00
20020506OR	508,00
20020506OM	508,00
20020506NE	358,00
20020506BL	358,00

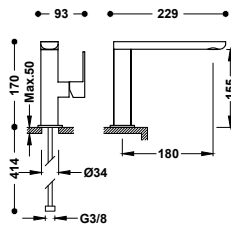

Single-handle washbasin mixer tap with lateral lever
G3/8 flexible hoses.

Miscelatore monocomando con leva laterale per lavabo
Flessibili di alimentazione G3/8.



20020501	194,00
20020501NM	301,00
20020501BM	301,00
20020501AC	301,00
20020501OR	427,00
20020501OM	427,00
20020501NE	301,00
20020501BL	301,00

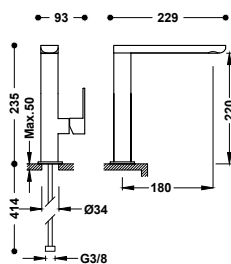

High single-handle washbasin mixer tap with lateral lever
G3/8 flexible hoses.

Miscelatore monocomando alto con leva laterale per lavabo
Flessibili di alimentazione G3/8.



20020502	215,00
20020502NM	334,00
20020502BM	334,00
20020502AC	334,00
20020502OR	474,00
20020502OM	474,00
20020502NE	334,00
20020502BL	334,00

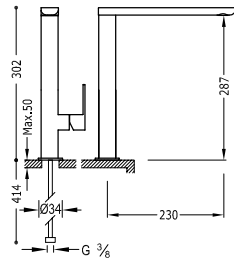

XXL single-handle washbasin mixer tap with lateral lever

G3/8 flexible hoses.

Miscelatore monocomando XXL con leva laterale per lavabo

Flessibili di alimentazione G3/8.



20020503	236,00
20020503NM	366,00
20020503BM	366,00
20020503AC	366,00
20020503OR	520,00
20020503OM	520,00
20020503NE	366,00
20020503BL	366,00

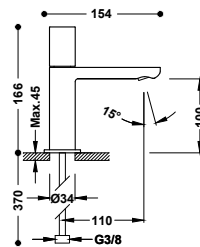

Washbasin tap with 1 water outlet

With G3/8 flexible shower hose.

Rubinetto monoacqua per lavabo

Con flessibili di alimentazione G3/8.



20050301	100,00
20050301NM	155,00
20050301BM	155,00
20050301AC	155,00
20050301OR	219,00
20050301OM	219,00

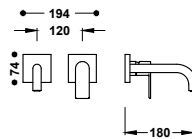

Visible part for recessed sink body

Visible part only. Includes concealing plate, handle and 180 mm spout. Recessed body not included.

Elemento a vista per il corpo a incasso da lavello

Solo parte a vista. Include piastra decorativa, comando e beccuccio da 180 mm. Corpo a incasso non incluso.



20030021	150,00
20030021NM	233,00
20030021BM	233,00
20030021AC	233,00
20030021OR	330,00
20030021OM	330,00



Recessed body for sink tap

20830002 85,00

Corpo a incasso per rubinetto da lavello

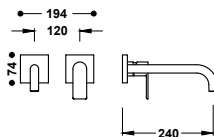

Visible part for recessed sink body

Visible part only. Includes concealing plate, handle and 240 mm spout. Recessed body not included.

Elemento a vista per il corpo a incasso da lavello

Solo parte a vista. Include piastra decorativa, comando e beccuccio da 240 mm. Corpo a incasso non incluso.



20030022	160,00
20030022NM	248,00
20030022BM	248,00
20030022AC	248,00
20030022OR	352,00
20030022OM	352,00



Recessed body for sink tap

20830002 85,00

Corpo a incasso per rubinetto da lavello

BIDET TAPS / RUBINETTI PER BIDET

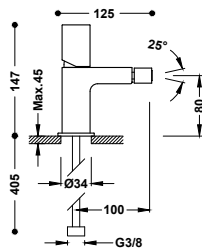

Single-handle bidet mixer tap

Adjustable shower head. G3/8 flexible hoses.

Miscelatore monocomando per bidet

Supporto orientabile. Flessibili di alimentazione G3/8.



	20012002	134,00
	20012002D	158,00
	20012002NM	208,00
	20012002BM	208,00
	20012002AC	208,00
	20012002OR	296,00
	20012002OM	296,00
	20012002NE	208,00
	20012002BL	208,00

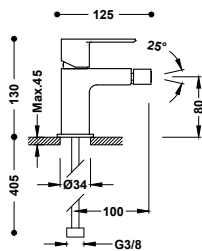

Single-handle bidet mixer tap

Adjustable shower head. G3/8 flexible hoses.

Miscelatore monocomando per bidet

Supporto orientabile. Flessibili di alimentazione G3/8.



	20012001	134,00
	20012001D	158,00
	20012001NM	208,00
	20012001BM	208,00
	20012001AC	208,00
	20012001OR	296,00
	20012001OM	296,00
	20012001NE	208,00
	20012001BL	208,00

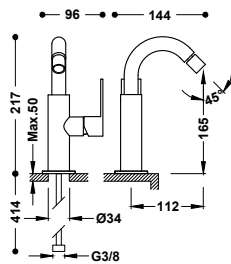

Single-handle bidet mixer tap with lateral lever

Adjustable shower head. G3/8 flexible hoses.

Miscelatore monocomando con leva laterale per bidet

Supporto orientabile. Flessibili di alimentazione G3/8.



	20022401	202,00
	20022401NM	312,00
	20022401BM	312,00
	20022401AC	312,00
	20022401OR	444,00
	20022401OM	444,00
	20022401NE	312,00
	20022401BL	312,00

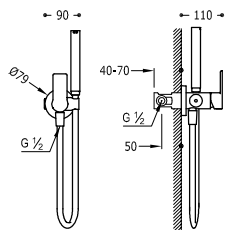

Concealed single lever WC/ bidet mixer

With cold and hot water. Hand shower with 5 l/min limiter coupling and non-drip system. Fixed support for hand shower for installation on right or left. Satin hose.

Miscelatore monocomando con doccia per wc

Con acqua fredda e calda. Doccino con limitatore a 5 l/min. e sistema antigocciolamento. Supporto fisso per doccia installabile a destra o a sinistra. Flessibile satinato.



	20522301	189,00
	20522301NM	293,00
	20522301BM	293,00
	20522301AC	293,00
	20522301OR	416,00
	20522301OM	416,00

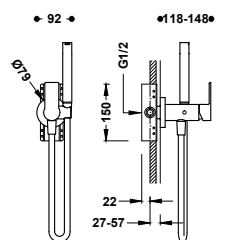

Concealed single lever WC/ bidet mixer

Option for plasterboard walls. With cold or hot water. Hand shower with 5 l/min limiter coupling and non-drip system. Fixed support for hand shower for installation on right or left. Satin hose.

Miscelatore monocomando con doccia per wc

Opzione per pareti in cartongesso. Con acqua fredda o calda. Doccino con limitatore a 5 l/min. e sistema antigocciolamento. Supporto fisso per doccia installabile a destra o a sinistra. Flessibile satinato.



	20522201	231,00
	20522201NM	358,00
	20522201BM	358,00
	20522201AC	358,00



Towel holder accessory for toilet mixer tap with shower

Installable support for right or left side (for ref.: 134122, 134123, 181122, 181123, 181222, 181223, 20522201, 20522301). Length: 180 mm.

Portasciugamano per rubinetto con doccino per wc

Supporto installabile a destra o a sinistra (per rif.: 134122, 134123, 181122, 181123, 181222, 181223, 20522201, 20522301). Lung.: 180 mm.

	03412401	37,00
	03412401NM	57,00
	03412401BM	57,00
	03412401AC	57,00
	03412401OR	81,00
	03412401OM	81,00

WALL TAPS / RUBINETTI A MURO

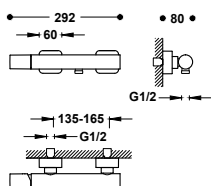

Wall-mounted single-handle shower mixer tap

Anti-limescale hand shower. Adjustable support for hand shower. Satin hose.

Miscelatore monocomando a muro per doccia

Doccino anticalcare. Supporto orientabile per doccino. Flessibile satinato.

	20016701	247,00
	20016701NM	382,00
	20016701BM	382,00
	20016701AC	382,00
	20016701OR	543,00
	20016701OM	543,00

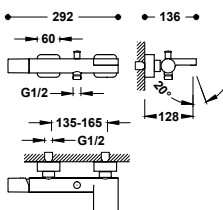

Wall-mounted single-handle mixer tap for bath and shower

Anti-limescale hand shower. With cascade outlet. Adjustable support for hand shower. Satin hose.

Miscelatore monocomando a muro per vasca e doccia

Doccino anticalcare. Con getto a cascata. Supporto orientabile per doccino. Flessibile satinato.

	20017001	268,00
	20017001NM	415,00
	20017001BM	415,00
	20017001AC	415,00
	20017001OR	589,00
	20017001OM	589,00



CONCEALED TAPS / RUBINETTI DA INCASSO

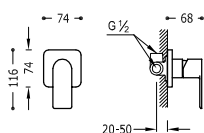

1-way concealed single-handle shower mixer tap

Concealed body included.

Miscelatore monocomando a incasso 1 getto per doccia

Corpo a incasso incluso.

	20017701	116,00
--	----------	--------

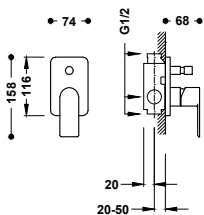

2-way concealed single-handle shower mixer tap

Concealed body included. 2-way diverter.

Miscelatore monocomando a incasso 2 getti per doccia

Corpo a incasso incluso. Inverter a 2 getti.

	20018001	179,00
	20018001NM	277,00
	20018001BM	277,00
	20018001AC	277,00
	20018001OR	393,00
	20018001OM	393,00



Extension set for 2-way concealed single-handle mixer taps

Set di estensione per miscelatori monocomando a incasso 2 getti

	20018010	100,00
--	----------	--------



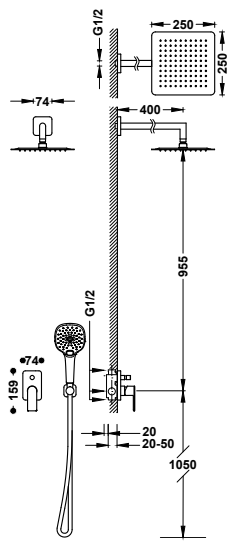

2-way concealed single-handle shower mixer tap kit

20018011 453,00

- Concealed body included.
- 2-way diverter.
- Wall-mounted arm with adjustable stainless steel shower head: 250x250 mm.
- Wall-mounted support for hand shower with water supply.
- Anti-limescale hand showers: 120x120 mm. (3 stream types).
- Satin hose.

Kit di miscelatore monocomando a incasso 2 getti per doccia

- Corpo a incasso incluso.
- Inverter a 2 getti.
- Braccio a muro con soffione doccia orientabile in acciaio inossidabile: 250x250 mm.
- Supporto per doccia con presa d'acqua a muro.
- Doccino anticalcare: 120x120 mm. (3 tipi di getto).
- Flessibile satinato.

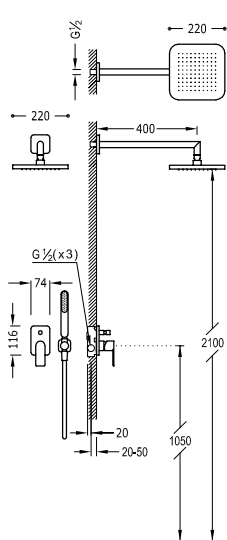

2-way concealed single-handle shower mixer tap kit

20018002 479,00

- Concealed body included.
- 2-way diverter.
- Wall-mounted arm with adjustable shower head: 220x220 mm.
- Wall-mounted support for hand shower with water supply.
- Anti-limescale hand shower.
- Satin hose.

Kit di miscelatore monocomando a incasso 2 getti per doccia

- Corpo a incasso incluso.
- Inverter a 2 getti.
- Braccio a muro con soffione doccia orientabile: 220x220 mm.
- Supporto per doccia con presa d'acqua a muro.
- Doccino anticalcare.
- Flessibile satinato.

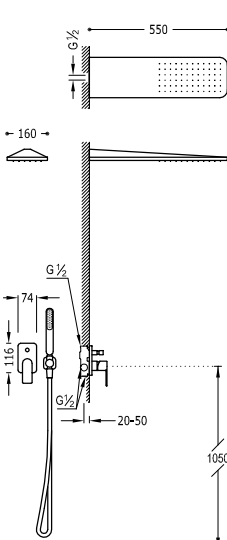
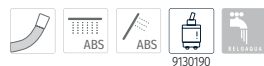

2-way concealed single-handle shower mixer tap kit

20018005 725,00
 20018005NM 1.124,00
 20018005BM 1.124,00
 20018005AC 1.124,00
 20018005OR 1.596,00
 20018005OM 1.596,00

- Concealed body included.
- 2-way diverter.
- Stainless steel wall-mounted shower head: 160x550 mm.
- Wall-mounted support for hand shower with water supply.
- Anti-limescale hand shower.
- Satin hose.

Kit di miscelatore monocomando a incasso 2 getti per doccia

- Corpo a incasso incluso.
- Inverter a 2 getti.
- Soffione doccia a muro in acciaio inossidabile: 160x550 mm.
- Supporto per doccia con presa d'acqua a muro.
- Doccino anticalcare.
- Flessibile satinato.



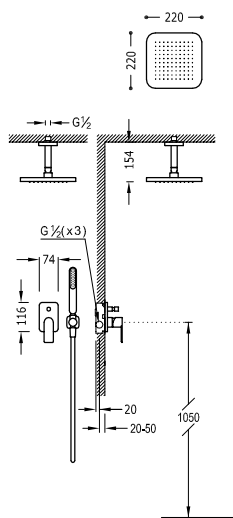

2-way concealed single-handle shower mixer tap kit

20018080

446,00

- Concealed body included.
- 2-way diverter.
- Ceiling-mounted arm with adjustable shower head: 220x220 mm.
- Wall-mounted support for hand shower with water supply.
- Anti-limescale hand shower.
- Satin hose.

Kit di miscelatore monocomando a incasso 2 getti per doccia

- Corpo a incasso incluso.
- Inverter a 2 getti.
- Braccio a soffitto con soffione doccia orientabile: 220x220 mm.
- Supporto per doccino con presa d'acqua a muro.
- Doccino anticalcare.
- Flessibile satinato.

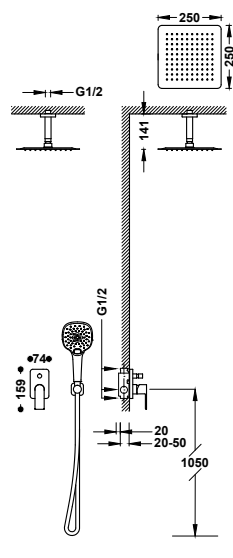

2-way concealed single-handle shower mixer tap kit

20018009

419,00

- Concealed body included.
- 2-way diverter.
- Ceiling-mounted arm with adjustable stainless steel shower head: 250x250 mm.
- Wall-mounted support for hand shower with water supply.
- Anti-limescale hand showers: 120x120 mm. (3 stream types).
- Satin hose.

Kit di miscelatore monocomando a incasso 2 getti per doccia

- Corpo a incasso incluso.
- Inverter a 2 getti.
- Braccio a soffitto con soffione doccia orientabile in acciaio inossidabile: 250x250mm.
- Supporto per doccino con presa d'acqua a muro.
- Doccino anticalcare: 120x120 mm. (3 tipi di getto).
- Flessibile satinato.



BATH TAPS / RUBINETTI PER VASCA

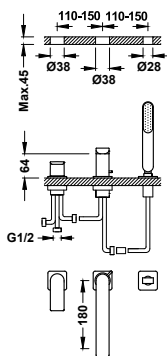

Single-handle bath edge mixer tap

20016203

390,00

- Inverter integrated into the bath spout.
- Anti-limescale hand shower.
- 180 mm bath spout. Water flow: 3 bar - 16 l/min.
- Optional tank kit not included ref.: 20324501.

Miscelatore monocomando bordo vasca

- Inverter incorporato nella canna della vasca.
- Doccino anticalcare.
- Canna della vasca di 180 mm. Flusso: 3 bar - 16 l/min.
- Kit contenitore opzionale non incluso rif: 20324501.



Tank for bath edge tapware
Contenitore per kit di miscelazione bordo vasca

20324501

415,00

134445 →406

Click-clack drainage valve for bath with overflow and drainage point
Valvola di scarico Click-clack per vasca con troppopieno e presa drenaggio

134445

100,00

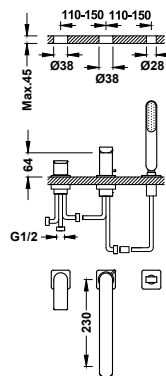

Single-handle bath edge mixer tap

- Inverter integrated into the bath spout.
- Anti-limescale hand shower.
- 230 mm bath spout. Water flow: 3 bar - 16 l/min.
- Optional tank kit not included ref: 20324501.

	20016201	400,00
	20016201NM	620,00
	20016201BM	620,00
	20016201AC	620,00
	20016201OR	880,00
	20016201OM	880,00

Miscelatore monocomando bordo vasca

- Inverter incorporato nella canna della vasca.
- Doccino anticalcare.
- Canna della vasca di 230 mm. Flusso: 3 bar - 16 l/m.
- Kit contenitore opzionale non incluso rif: 20324501.



Tank for bath edge tapware
Contenitore per kit di miscelazione bordo vasca

	20324501	415,00
--	----------	--------

→406



Click-clack drainage valve for bath with overflow and drainage point
Valvola di scarico Click-clack per vasca con troppopieno e presa drenaggio

	134445	100,00
--	--------	--------

THERMOSTATIC WALL TAPS / RUBINETTO TERMOSTATICI A MURO

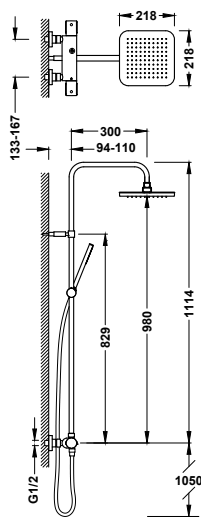

2-way Over-wall thermostatic shower mixer tap set

	19039318	443,00
--	----------	--------

- With diverter integrated into the flow regulator.
- ABS round handle.
- Adjustable shower head: 218x218 mm.
- Adjustable and sliding support for hand shower.
- Anti-limescale hand shower.
- Metal hose.

Set di miscelatore termostatico a muro Over-wall 2 getti per doccia

- Con inverter incorporato nel regolatore di flusso.
- Manopola rotonda in ABS.
- Soffione doccia orientabile: 218x218 mm.
- Supporto scorrevole e orientabile per doccino.
- Doccino anticalcare
- Flessibile in metallo.

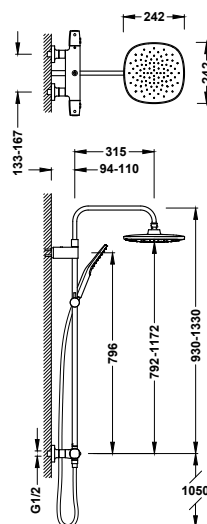

2-way Over-wall thermostatic shower mixer tap set

	19038707	435,00
--	----------	--------

- With diverter integrated into the flow regulator.
- Telescopic shower bar.
- Handle with rounded edges.
- Adjustable shower head: 242x242 mm.
- Adjustable and sliding support for hand shower.
- Anti-limescale hand showers: 120x120 mm. (3 stream types).
- Satin hose.

Set di miscelatore termostatico a muro Over-wall 2 getti per doccia

- Con inverter incorporato nel regolatore di flusso.
- Colonna doccia telescopica.
- Manopola con bordi arrotondati.
- Soffione doccia orientabile: 242x242 mm.
- Supporto scorrevole e orientabile per doccino.
- Doccino anticalcare: 120x120 mm. (3 tipi di getto).
- Flessibile satinato.



THERMOSTATIC CONCEALED TAPS / RUBINETTI TERMOSTATICI DA INCASSO

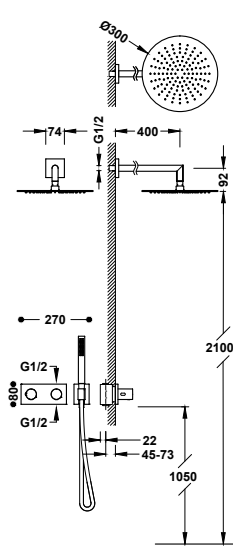

B-system 2-way concealed thermostatic shower mixer tap kit

- Concealed thermostatic body for horizontal installation included.
- Flow regulator and 2-way ceramic distributor.
- Round handle.
- Wall-mounted arm with adjustable stainless steel shower head: Ø 300 mm.
- Wall-mounted support for hand shower with water supply.
- Anti-limescale brass hand shower.
- Satin hose.

Kit di miscelatore termostatico a incasso 2 getti B-system per doccia

- Corpo termostatico a incasso con installazione orizzontale inclusa.
- Regolatore di flusso ed erogatore in ceramica a 2 getti.
- Manopola rotonda.
- Braccio a muro con soffione doccia orientabile in acciaio inossidabile: Ø 300 mm.
- Supporto per doccia con presa d'acqua a muro.
- Doccino anticalcare in ottone.
- Flessibile satinato.



30735204	811,00
30735204NM	1.163,00
30735204AC	1.163,00
30735204OR	1.651,00
30735204OM	1.651,00

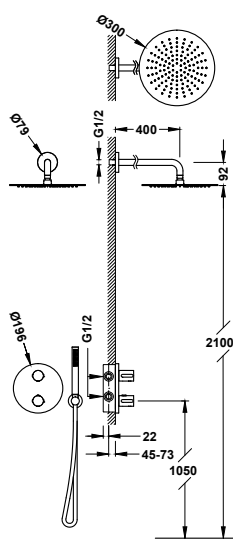

Therm-box 2-way concealed thermostatic tap kit for showers

- Concealed body included.
- Round handle with temperature control. 2-way ceramic distributor.
- Wall-mounted arm with adjustable stainless steel shower head: Ø 300 mm.
- Wall-mounted support for hand shower with water supply.
- Anti-limescale brass hand shower.
- Satin hose.

Kit di miscelatore termostatico da incasso a 2 getti Therm-box per doccia

- Corpo a incasso incluso.
- Manopola rotonda con controllo della temperatura. Erogatore in ceramica a 2 getti.
- Braccio a muro con soffione doccia orientabile in acciaio inossidabile: Ø 300 mm.
- Supporto per doccia con presa d'acqua a muro.
- Doccino anticalcare in ottone.
- Flessibile satinato.



26225004	585,00
26225004NM	837,00
26225004BM	837,00
26225004AC	837,00
26225004OR	1.136,00
26225004OM	1.136,00

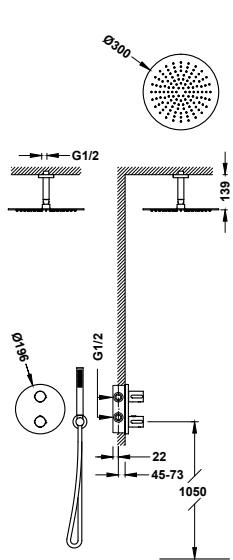

Therm-box 2-way concealed thermostatic tap kit for showers

- Concealed body included.
- Round handle with temperature control. 2-way ceramic distributor.
- Ceiling-mounted arm with adjustable stainless steel shower head: Ø 300 mm.
- Wall-mounted support for hand shower with water supply.
- Anti-limescale brass hand shower.
- Satin hose.

Kit di miscelatore termostatico da incasso a 2 getti Therm-box per doccia

- Corpo a incasso incluso.
- Manopola rotonda con controllo della temperatura. Erogatore in ceramica a 2 getti.
- Braccio a soffitto con soffione doccia orientabile in acciaio inossidabile: Ø 300 mm.
- Supporto per doccia con presa d'acqua a muro.
- Doccino anticalcare in ottone.
- Flessibile satinato.



26225003	558,00
26225003NM	797,00
26225003BM	797,00
26225003AC	797,00
26225003OR	1.078,00
26225003OM	1.078,00

SHUT-OFF VALVES / VALVOLE DI INTERCETTAZIONE

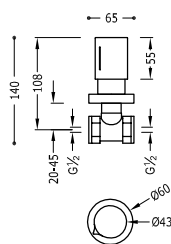

Concealed shut-off valve

Female thread connection: 1/2".

Valvola di intercettazione a incasso

Attacco a filetto femmina: 1/2".

06115501	83,00
06115501NM	128,00
06115501BM	128,00
06115501AC	128,00
06115501OR	182,00
06115501OM	182,00

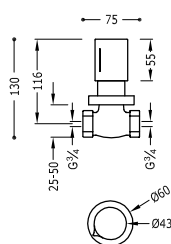

Concealed shut-off valve

Female thread connection: 3/4".

Valvola di intercettazione a incasso

Attacco a filetto femmina: 3/4".

06151101	91,00
06151101NM	140,00
06151101BM	140,00
06151101AC	140,00
06151101OR	199,00
06151101OM	199,00



FUJI

The conical shapes of the Fuji collection from Tres are represented in each of the pieces. Its twisty silhouette is what achieves this dynamic effect that is so attractive for modern bathrooms, elevating the presence and visibility of each tap.

Le forme coniche della collezione Fuji de Tres sono rappresentate in ognuno dei pezzi. La loro silhouette sinuosa raggiunge questo dinamismo così attraente per i bagni moderni e aumenta la visibilità e la presenza di ogni rubinetto.







WASHBASIN TAPS / RUBINETTI PER LAVABO

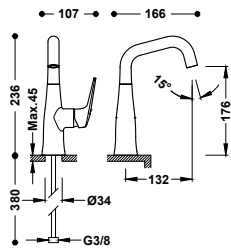

Single-handle washbasin mixer tap with lateral lever

G3/8 flexible hoses.

Miscelatore monocomando con leva laterale per lavabo

Flessibili di alimentazione G3/8.

28144701	210,00
28144701NM	326,00
28144701AC	326,00
28144701OPM	462,00



29902804

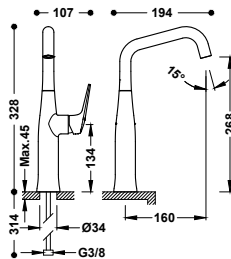

High single-handle washbasin mixer tap with lateral lever

G3/8 flexible hoses.

Miscelatore monocomando alto con leva laterale per lavabo

Flessibili di alimentazione G3/8.

28164701	221,00
28164701NM	342,00
28164701AC	342,00
28164701OPM	485,00



29902804

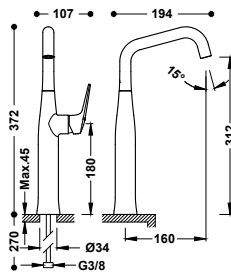

XXL single-handle washbasin mixer tap with lateral lever

G3/8 flexible hoses.

Miscelatore monocomando XXL con leva laterale per lavabo

Flessibili di alimentazione G3/8.

28184701	236,00
28184701NM	366,00
28184701AC	366,00
28184701OPM	520,00



29902804

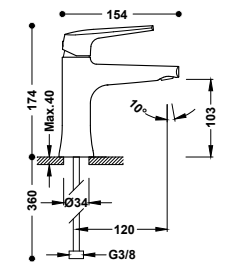

Single-handle washbasin mixer tap

G3/8 flexible hoses.

Miscelatore monocomando per lavabo

Flessibili di alimentazione G3/8.

28110301	121,00
28110301NM	187,00
28110301AC	187,00
28110301OPM	266,00



5,7 lpm 29902802

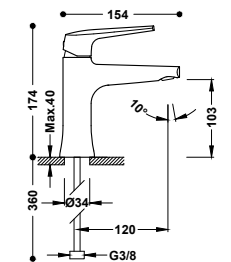

Eco-efficient single-handle washbasin mixer tap

G3/8 flexible hoses.

Miscelatore monocomando ecoefficiente per lavabo

Flessibili di alimentazione G3/8.

28110401	129,00
28110401NM	200,00
28110401AC	200,00
28110401OPM	284,00



5,7 lpm 29902808

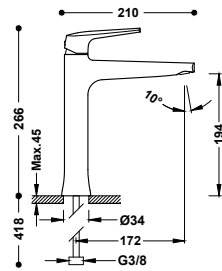

High single-handle washbasin mixer tap

G3/8 flexible hoses.

Miscelatore monocomando alto per lavabo

Flessibili di alimentazione G3/8.



	28120301	236,00
	28120301NM	366,00
	28120301AC	366,00
	28120301OPM	520,00

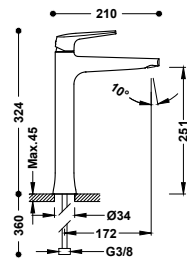

XXL single-handle washbasin mixer tap

G3/8 flexible hoses.

Miscelatore monocomando XXL per lavabo

Flessibili di alimentazione G3/8.



	28180301	273,00
	28180301NM	423,00
	28180301AC	423,00
	28180301OPM	601,00

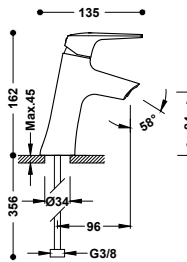

Inclined single-handle washbasin mixer tap

G3/8 flexible hoses.

Miscelatore monocomando inclinato per lavabo

Flessibili di alimentazione G3/8.



	28190301	125,00
	28190301NM	194,00
	28190301AC	194,00
	28190301OPM	275,00

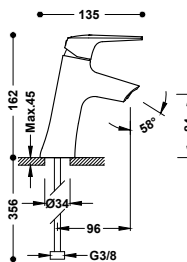

Single-lever eco-efficient inclined mixer tap for washbasin

G3/8 flexible hoses.

Miscelatore monocomando inclinato eco-efficiente per lavabo

Flessibili di alimentazione G3/8.



	28110402	133,00
	28110402NM	207,00
	28110402AC	207,00
	28110402OPM	293,00

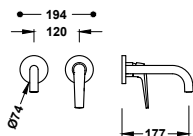





Visible part for recessed sink body

Visible part only. Includes concealing plate, handle and 177 mm spout. Recessed body not included.

Elemento a vista per il corpo a incasso da lavello

Solo parte a vista. Include piastra decorativa, comando e beccuccio da 177 mm. Corpo a incasso non incluso.

	28130021	145,00
	28130021NM	225,00
	28130021AC	225,00
	28130021OPM	352,00



Recessed body for sink tap

20830002

85,00

Corpo a incasso per rubinetto da lavello

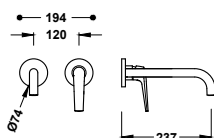

Visible part for recessed sink body

Visible part only. Includes concealing plate, handle and 237 mm spout. Recessed body not included.

Elemento a vista per il corpo a incasso da lavello

Solo parte a vista. Include piastra decorativa, comando e beccuccio da 237 mm. Corpo a incasso non incluso.

	28130022	155,00
	28130022NM	240,00
	28130022AC	240,00
	28130022OPM	341,00



Recessed body for sink tap

20830002

85,00

Corpo a incasso per rubinetto da lavello

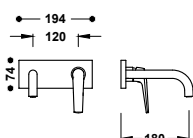





Visible part for recessed sink body

Visible part only. Includes concealing plate, handle and 180 mm spout. Recessed body not included.

Elemento a vista per il corpo a incasso da lavello

Solo parte a vista. Include piastra decorativa, comando e beccuccio da 180 mm. Corpo a incasso non incluso.

	28130023	185,00
	28130023NM	287,00
	28130023AC	287,00
	28130023OPM	407,00



Recessed body for sink tap

20830002

85,00

Corpo a incasso per rubinetto da lavello

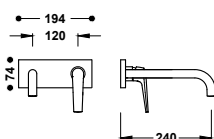

Visible part for recessed sink body

Visible part only. Includes concealing plate, handle and 240 mm spout. Recessed body not included.

Elemento a vista per il corpo a incasso da lavello

Solo parte a vista. Include piastra decorativa, comando e beccuccio da 240 mm. Corpo a incasso non incluso.

	28130024	195,00
	28130024NM	302,00
	28130024AC	302,00
	28130024OPM	429,00



Recessed body for sink tap

20830002

85,00

Corpo a incasso per rubinetto da lavello

BIDET TAPS / RUBINETTI PER BIDET

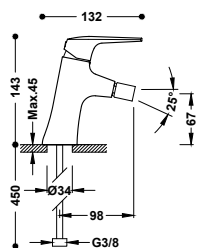

Single-handle bidet mixer tap

Adjustable shower head. G3/8 flexible hoses.

Miscelatore monocomando per bidet

Supporto orientabile. Flessibili di alimentazione G3/8.

	28112001	128,00
	28112001NM	199,00
	28112001AC	199,00
	28112001OPM	282,00



29902802

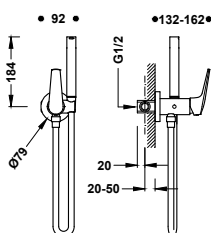

Concealed single lever WC/ bidet mixer

With cold and hot water. Hand shower with 5 l/min limiter coupling and non-drip system. Fixed support for hand shower for installation on right or left. Satin hose.

Miscelatore monocomando con doccia per wc

Con acqua fredda e calda. Doccino con limitatore a 5 l/min. e sistema antigocciolamento. Supporto fisso per doccia installabile a destra o a sinistra. Flessibile satinato.

	28112301	180,00
	28112301NM	279,00
	28112301AC	279,00
	28112301OPM	396,00



9134591



Towel holder accessory for toilet mixer tap with shower

Installable support for right or left side (for ref.: 134122, 134123, 181122, 181123, 181222, 181223, 20522201, 20522301). Length: 180 mm.

Portasciugamano per rubinetto con doccia per wc

Supporto installabile a destra o a sinistra (per rif.: 134122, 134123, 181122, 181123, 181222, 181223, 20522201, 20522301). Lung.: 180 mm.

	03412401	37,00
	03412401NM	57,00
	03412401AC	57,00
	03412401OPM	81,00

WALL TAPS / RUBINETTI A MURO

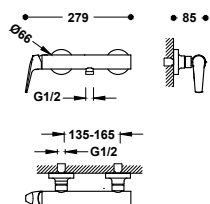

Wall-mounted single-handle shower mixer tap

Anti-limescale: Ø 110 mm hand shower. (3 stream types). Adjustable support for hand shower. Satin hose.

Miscelatore monocomando a muro per doccia

Doccino anticalcare: Ø 110 mm. (3 tipi di getto). Supporto orientabile per doccia. Flessibile satinato.

	28116701	242,00
	28116701NM	374,00
	28116701AC	374,00
	28116701OPM	531,00



29902802

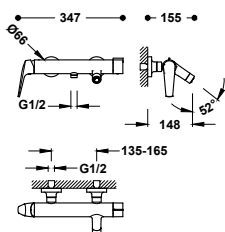

Wall-mounted single-handle mixer tap for bath and shower

With diverter integrated. Anti-limescale: Ø 110 mm hand shower. (3 stream types). Adjustable support for hand shower. Satin hose.

Miscelatore monocomando a muro per vasca e doccia

Con inverter incorporato. Doccino anticalcare: Ø 110 mm. (3 tipi di getto). Supporto orientabile per doccia. Flessibile satinato.

	28117001	263,00
	28117001NM	407,00
	28117001AC	407,00
	28117001OPM	578,00



29903516



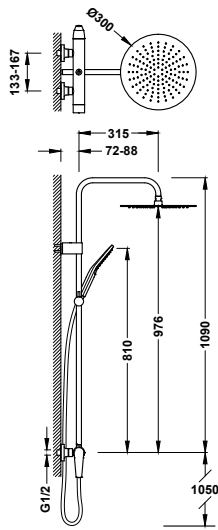

2-way wall-fitted single-handle shower mixer tap

- With diverter integrated.
- Stainless steel adjustable shower head: Ø 300 mm.
- Adjustable and sliding support for hand shower.
- Anti-limescale hand showers: Ø 110 mm. (3 stream types).
- Satin hose.

Set miscelatore monocomando a muro 2 getti per doccia

- Con inverter incorporato.
- Soffione doccia orientabile in acciaio inossidabile: Ø 300 mm.
- Supporto scorrevole e orientabile per doccino.
- Doccino anticalcare: Ø 110 mm. (3 tipi di getto).
- Flessibile satinato.



28119101	497,00
28119101NM	770,00
28119101AC	770,00
28119101OPM	1.093,00

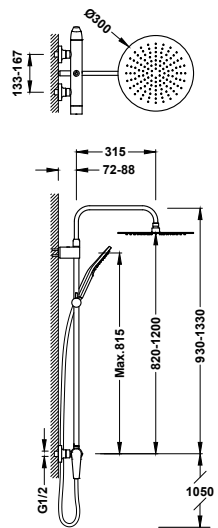

2-way wall-fitted single-handle shower mixer tap

- With diverter integrated.
- Stainless steel adjustable shower head: Ø 300 mm.
- Telescopic shower bar.
- Adjustable and sliding support for hand shower.
- Anti-limescale hand showers: Ø 110 mm. (3 stream types).
- Satin hose.

Set miscelatore monocomando a muro 2 getti per doccia

- Con inverter incorporato.
- Soffione doccia orientabile in acciaio inossidabile: Ø 300 mm.
- Colonna doccia telescopica.
- Supporto scorrevole e orientabile per doccino.
- Doccino anticalcare: Ø 110 mm. (3 tipi di getto).
- Flessibile satinato.



28119701	528,00
28119701NM	819,00
28119701AC	819,00
28119701OPM	1.162,00



CONCEALED TAPS/ RUBINETTI DA INCASSO

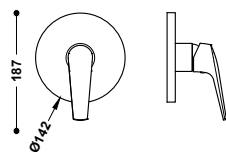

Visible part for concealed 1-way Rapid-box

Only visible part. Includes trim plate, control, bush and concealed attachment screw. Complete with concealed Rapid-box ref.: 20827810.

Pezzo vista per cassa da incasso a 1 via Rapid-box

Solo parte vista. Include piastra decorativa, comando, boccola e vite di fissaggio occulta. Completare con scatola da incasso Rapid-box rif.: 20827810.

28127810	79,00
28127810NM	122,00
28127810AC	122,00
28127810OPM	173,00



Concealed 1-way Rapid-box with single-handle mixer tap for shower

20827810	80,00
----------	-------

Scatola da incasso a 1 via Rapid-box con miscelatore monocomando per doccia

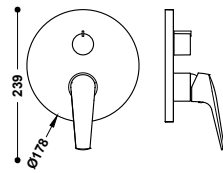





Visible part for concealed 2-way Rapid-box

Only visible part. Includes trim plate, control, distribution handle and concealed attachment screw. Complete with concealed Rapid-box ref: 20828110.

Pezzo vista per cassa da incasso a 2 vie Rapid-box

Solo parte vista. Include piastra decorativa, comando, volante distributore e vite di fissaggio occulta. Completare con scatola da incasso Rapid-box rif: 20828110.

	28128110	100,00
	28128110NM	155,00
	28128110AC	155,00
	28128110OPM	219,00



Concealed 2-way Rapid-box with single-handle mixer tap for shower and bath

20828110 90,00

Scatola da incasso a 2 vie Rapid-box con miscelatore monocomando per doccia e vasca da bagno

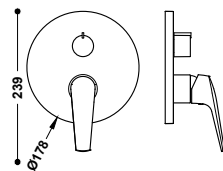





Visible part for concealed 3-way Rapid-box

Only visible part. Includes trim plate, control, distribution handle and concealed attachment screw. Complete with concealed Rapid-box ref: 20827310.

Pezzo vista per cassa da incasso a 3 vie Rapid-box

Solo parte vista. Include piastra decorativa, comando, volante distributore e vite di fissaggio occulta. Completare con scatola da incasso Rapid-box rif: 20827310.

	28127310	109,00
	28127310NM	169,00
	28127310AC	169,00
	28127310OPM	240,00

N



Concealed 3-way Rapid-box with single-handle mixer tap for shower and bath

20827310 95,00

Scatola da incasso a 3 vie Rapid-box con miscelatore monocomando per doccia e vasca da bagno

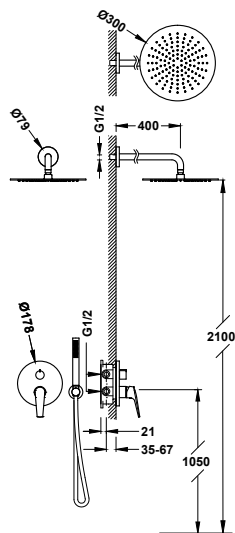





Rapid-box 2-way concealed single-handle shower mixer tap kit

- Concealed body included.
- 2-way ceramic distributor.
- Wall-mounted arm with stainless steel shower head: Ø 300 mm.
- Wall-mounted support for hand shower with water supply.
- Anti-limescale brass hand shower.
- Satin hose.

Kit di miscelatore monocomando a incasso 2 getti Rapid-box per doccia

- Corpo a incasso incluso.
- Erogatore in ceramica a 2 getti.
- Braccio a muro con soffione doccia orientabile in acciaio inossidabile: Ø 300 mm.
- Supporto per doccia con presa d'acqua a muro.
- Doccino anticalcare in ottone.
- Flessibile satinato.

	28128004	474,00
	28128004NM	691,00
	28128004AC	691,00
	28128004OPM	947,00



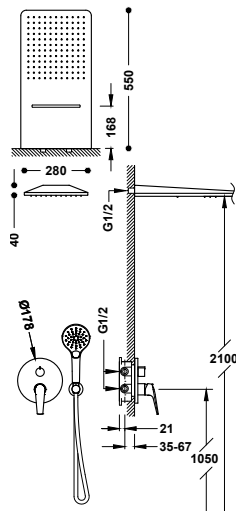

Rapid-box 3-way concealed single-handle shower mixer tap kit

- Concealed body included.
- 3-way ceramic distributor.
- Stainless steel wall-mounted shower head with 2 stream types (rain/cascade). 280x550 mm. **IMPORTANT:** Install a >50 l/min drain.
- Wall-mounted support for hand shower with water supply.
- Anti-limescale hand showers: Ø 110 mm. (3 stream types).
- Satin hose.

28127301	1.104,00
28127301NM	1.660,00
28127301AC	1.660,00
28127301OPM	2.318,00

Kit di miscelatore monocomando a incasso 3 getti Rapid-box per doccia

- Corpo a incasso incluso.
- Erogatore in ceramica a 3 getti.
- Soffione doccia a muro in acciaio inossidabile con 2 tipi di getto (pioggia/cascata). 280x550 mm. **IMPORTANT:** Montare uno scarico da >50 l/min.
- Supporto per doccia con presa d'acqua a muro.
- Doccino anticalcare: Ø 110 mm. (3 tipi di getto).
- Flessibile satinato.

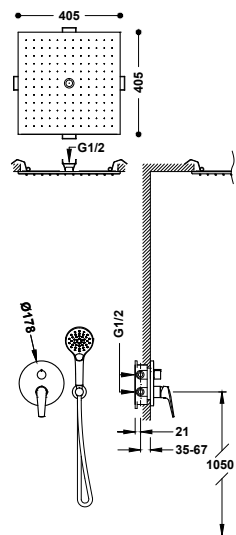

Rapid-box 3-way concealed single-handle shower mixer tap kit

- Concealed body included.
- 3-way ceramic distributor.
- Stainless steel concealed ceiling-mounted shower head with 2 stream types (rain/free flow). 405x405 mm.
- Wall-mounted support for hand shower with water supply.
- Anti-limescale hand showers: Ø 110 mm. (3 stream types).
- Satin hose.

28127302	1.180,00
28127302NM	1.780,00
28127302AC	1.780,00
28127302OPM	2.486,00

Kit di miscelatore monocomando a incasso 3 getti Rapid-box per doccia

- Corpo a incasso incluso.
- Erogatore in ceramica a 3 getti.
- Soffione doccia a incasso da soffitto in acciaio inossidabile con 2 tipi di getto (pioggia/free flow). 405x405 mm.
- Supporto per doccia con presa d'acqua a muro.
- Doccino anticalcare: Ø 110 mm. (3 tipi di getto).
- Flessibile satinato.



THERMOSTATIC WALL TAPS / RUBINETTO TERMOSTATICI A MURO

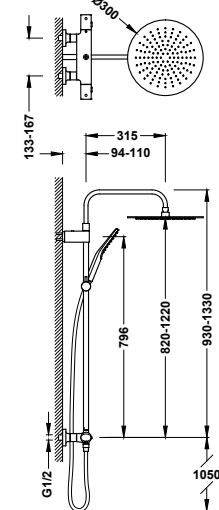

2-way Over-wall thermostatic shower mixer tap set

- With diverter integrated into the flow regulator.
- Oval handle.
- Telescopic shower bar.
- Stainless steel adjustable shower head: Ø 300 mm.
- Adjustable and sliding support for hand shower.
- Anti-limescale hand showers: Ø 110 mm. (3 stream types).
- Satin hose.

19038705	580,00
19038705NM	899,00
19038705AC	899,00
19038705OPM	1.276,00

Set di miscelatore termostatico a muro Over-wall 2 getti per doccia

- Con inverter incorporato nel regolatore di flusso.
- Manopola ovale.
- Colonna doccia telescopica.
- Soffione doccia orientabile in acciaio inossidabile: Ø 300 mm.
- Supporto scorrevole e orientabile per doccia.
- Doccino anticalcare: Ø 110 mm. (3 tipi di getto).
- Flessibile satinato.



THERMOSTATIC CONCEALED TAPS / RUBINETTI TERMOSTATICI DA INCASSO

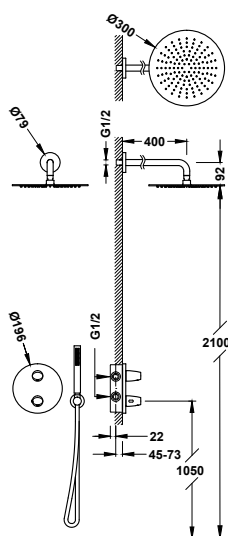

Therm-box 2-way concealed thermostatic tap kit for showers

- Concealed body included.
- Oval handle with temperature control. 2-way ceramic distributor.
- Wall-mounted arm with adjustable stainless steel shower head: Ø 300 mm.
- Wall-mounted support for hand shower with water supply.
- Anti-limescale brass hand shower.
- Satin hose.

Kit di miscelatore termostatico da incasso a 2 getti Therm-box per doccia

- Corpo a incasso incluso.
- Manopola ovale con controllo della temperatura. Erogatore in ceramica a 2 getti.
- Braccio a muro con soffione doccia orientabile in acciaio inossidabile: Ø 300 mm.
- Supporto per doccia con presa d'acqua a muro.
- Doccino anticalcare in ottone.
- Flessibile satinato.



28125004	566,00
28125004NM	806,00
28125004AC	806,00
28125004OPM	1.092,00

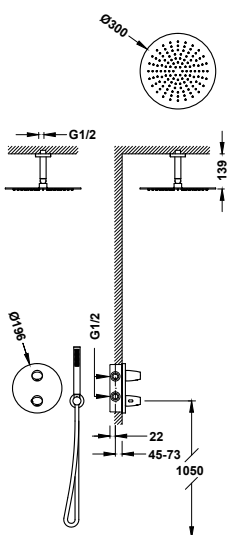

Therm-box 2-way concealed thermostatic tap kit for showers

- Concealed body included.
- Oval handle with temperature control. 2-way ceramic distributor.
- Ceiling-mounted arm with adjustable stainless steel shower head: Ø 300 mm.
- Wall-mounted support for hand shower with water supply.
- Anti-limescale brass hand shower.
- Satin hose.

Kit di miscelatore termostatico da incasso a 2 getti Therm-box per doccia

- Corpo a incasso incluso.
- Manopola ovale con controllo della temperatura. Erogatore in ceramica a 2 getti.
- Braccio a soffitto con soffione doccia orientabile in acciaio inossidabile: Ø 300 mm.
- Supporto per doccia con presa d'acqua a muro.
- Doccino anticalcare in ottone.
- Flessibile satinato.



28125003	538,00
28125003NM	766,00
28125003AC	766,00

SHUT-OFF VALVES / VALVOLE DI INTERCETTAZIONE

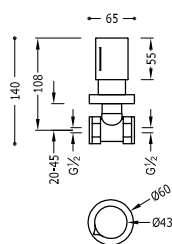





Concealed shut-off valve

Female thread connection: 1/2".

Valvola di intercettazione a incasso

Attacco a filetto femmina: 1/2".

	06115501	83,00
	06115501NM	128,00
	06115501AC	128,00
	06115501OPM	182,00

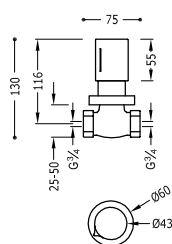





Concealed shut-off valve

Female thread connection: 3/4".

Valvola di intercettazione a incasso

Attacco a filetto femmina: 3/4".

	06151101	91,00
	06151101NM	140,00
	06151101AC	140,00
	06151101OPM	199,00





PROJECT-TRES

Project-tres is the most special series by Tres. It can be adapted to endless environments and features surprising finishes, mixing innovative technology with versatile design. There must be a reason why everyone loves it.

Project-tres è la serie più speciale di Tres. Adattabile a molti ambienti e con finiture sorprendenti, questa serie unisce l'innovazione tecnologica al design più versatile. Ecco perché piace a tutti.

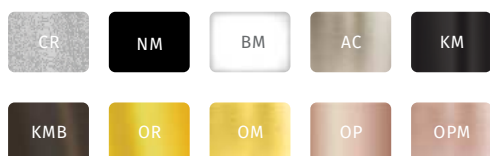





WASHBASIN TAPS / RUBINETTI PER LAVABO

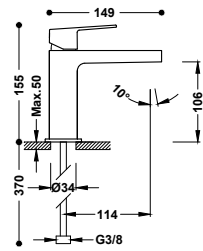

Single-handle washbasin mixer tap

G3/8 flexible hoses.

Miscelatore monocomando per lavabo

Flessibili di alimentazione G3/8.



■	21110301	111,00
■	21110301D	134,00
■	21110301NM	173,00
■	21110301BM	173,00
■	21110301AC	173,00
■	21110301KM	173,00
■	21110301KMB	173,00
■	21110301OR	245,00
■	21110301OM	245,00
■	21110301OP	245,00
■	21110301OPM	245,00

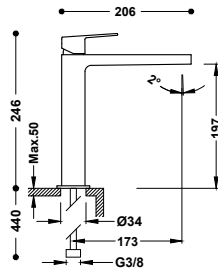

High single-handle washbasin mixer tap

G3/8 flexible hoses.

Miscelatore monocomando alto per lavabo

Flessibili di alimentazione G3/8.



■	21120301	233,00
■	21120301NM	361,00
■	21120301BM	361,00
■	21120301AC	361,00
■	21120301KM	361,00
■	21120301KMB	361,00
■	21120301OR	513,00
■	21120301OM	513,00
■	21120301OP	513,00
■	21120301OPM	513,00

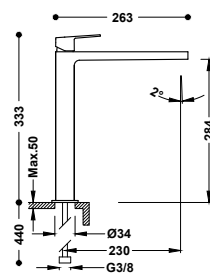

XXL single-handle washbasin mixer tap

G3/8 flexible hoses.

Miscelatore monocomando XXL per lavabo

Flessibili di alimentazione G3/8.



■	21180301	268,00
■	21180301NM	415,00
■	21180301BM	415,00
■	21180301AC	415,00
■	21180301KM	415,00
■	21180301KMB	415,00
■	21180301OR	589,00
■	21180301OM	589,00
■	21180301OP	589,00
■	21180301OPM	589,00

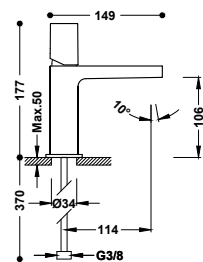

Single-handle washbasin mixer tap

G3/8 flexible hoses.

Miscelatore monocomando per lavabo

Flessibili di alimentazione G3/8.



■	21110302	111,00
■	21110302D	134,00
■	21110302NM	173,00
■	21110302BM	173,00
■	21110302AC	173,00
■	21110302KM	173,00
■	21110302KMB	173,00
■	21110302OR	245,00
■	21110302OM	245,00
■	21110302OP	245,00
■	21110302OPM	245,00

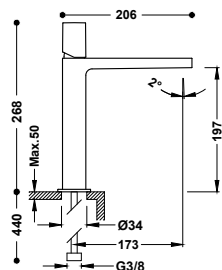

High single-handle washbasin mixer tap

G3/8 flexible hoses.

Miscelatore monocomando alto per lavabo

Flessibili di alimentazione G3/8.



21120302	233,00
21120302NM	361,00
21120302BM	361,00
21120302AC	361,00
21120302KM	361,00
21120302KMB	361,00
21120302OR	513,00
21120302OM	513,00
21120302OP	513,00
21120302OPM	513,00

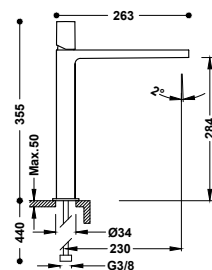

XXL single-handle washbasin mixer tap

G3/8 flexible hoses.

Miscelatore monocomando XXL per lavabo

Flessibili di alimentazione G3/8.



21180302	268,00
21180302NM	415,00
21180302BM	415,00
21180302AC	415,00
21180302KM	415,00
21180302KMB	415,00
21180302OR	589,00
21180302OM	589,00
21180302OP	589,00
21180302OPM	589,00

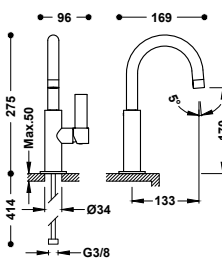

Single-handle washbasin mixer tap with lateral lever

G3/8 flexible hoses.

Miscelatore monocomando con leva laterale per lavabo

Flessibili di alimentazione G3/8.



21190401	208,00
21190401NM	322,00
21190401BM	322,00
21190401AC	322,00
21190401KM	322,00
21190401KMB	322,00
21190401OR	457,00
21190401OM	457,00
21190401OP	457,00
21190401OPM	457,00

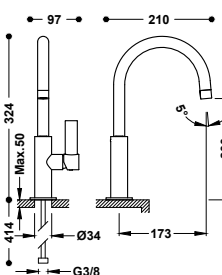

High single-handle washbasin mixer tap with lateral lever

G3/8 flexible hoses.

Miscelatore monocomando alto con leva laterale per lavabo

Flessibili di alimentazione G3/8.



21190501	218,00
21190501NM	339,00
21190501BM	339,00
21190501AC	339,00
21190501KM	339,00
21190501KMB	339,00
21190501OR	480,00
21190501OM	480,00
21190501OP	480,00
21190501OPM	480,00

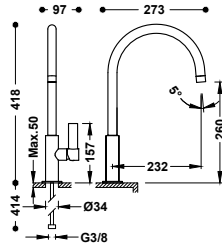

XXL single-handle washbasin mixer tap with lateral lever

G3/8 flexible hoses.

Miscelatore monocomando XXL con leva laterale per lavabo

Flessibili di alimentazione G3/8.



21190601	229,00
21190601NM	355,00
21190601BM	355,00
21190601AC	355,00
21190601KM	355,00
21190601KMB	355,00
21190601OR	504,00
21190601OM	504,00
21190601OP	504,00
21190601OPM	504,00

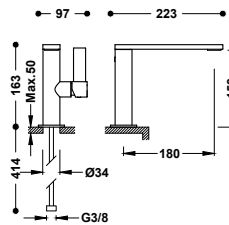

Single-handle washbasin mixer tap with lateral lever

G3/8 flexible hoses.

Miscelatore monocomando con leva laterale per lavabo

Flessibili di alimentazione G3/8.



21120501	184,00
21120501NM	285,00
21120501BM	285,00
21120501AC	285,00
21120501KM	285,00
21120501KMB	285,00
21120501OR	404,00
21120501OM	404,00
21120501OP	404,00
21120501OPM	404,00

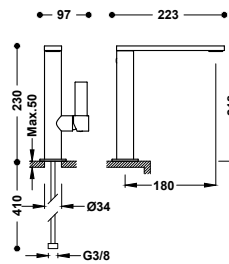

High single-handle washbasin mixer tap with lateral lever

G3/8 flexible hoses.

Miscelatore monocomando alto con leva laterale per lavabo

Flessibili di alimentazione G3/8.



21130501	205,00
21130501NM	317,00
21130501BM	317,00
21130501AC	317,00
21130501KM	317,00
21130501KMB	317,00
21130501OR	450,00
21130501OM	450,00
21130501OP	450,00
21130501OPM	450,00

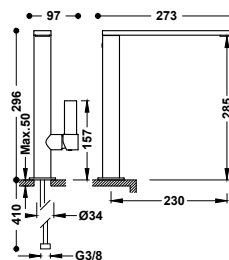

XXL single-handle washbasin mixer tap with lateral lever

G3/8 flexible hoses.

Miscelatore monocomando XXL con leva laterale per lavabo

Flessibili di alimentazione G3/8.



21140501	226,00
21140501NM	350,00
21140501BM	350,00
21140501AC	350,00
21140501KM	350,00
21140501KMB	350,00
21140501OR	497,00
21140501OM	497,00
21140501OP	497,00
21140501OPM	497,00

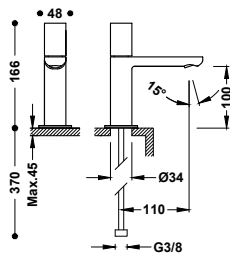

Washbasin tap with 1 water outlet

With G3/8 flexible shower hose.

Rubinetto monoacqua per lavabo

Con flessibili di alimentazione G3/8.



21150301	105,00
21150301NM	163,00
21150301BM	163,00
21150301AC	163,00
21150301KM	163,00
21150301KMB	163,00
21150301OR	231,00
21150301OM	231,00
21150301OP	231,00
21150301OPM	231,00

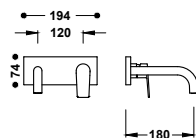

Visible part for recessed sink body

Visible part only. Includes concealing plate, handle and 180 mm spout. Recessed body not included.

Elemento a vista per il corpo a incasso da lavello

Solo parte a vista. Include piastra decorativa, comando e beccuccio da 180 mm. Corpo a incasso non incluso.



21130031	175,00
21130031NM	271,00
21130031BM	271,00
21130031AC	271,00
21130031KM	271,00
21130031KMB	271,00
21130031OR	385,00
21130031OM	385,00
21130031OP	385,00
21130031OPM	385,00



Recessed body for sink tap

20830002

85,00

Corpo a incasso per rubinetto da lavello

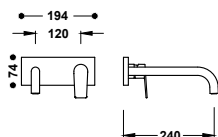

Visible part for recessed sink body

Visible part only. Includes concealing plate, handle and 240 mm spout. Recessed body not included.

Elemento a vista per il corpo a incasso da lavello

Solo parte a vista. Include piastra decorativa, comando e beccuccio da 240 mm. Corpo a incasso non incluso.



21130032	185,00
21130032NM	287,00
21130032BM	287,00
21130032AC	287,00
21130032KM	287,00
21130032KMB	287,00
21130032OR	407,00
21130032OM	407,00
21130032OP	407,00
21130032OPM	407,00



Recessed body for sink tap

20830002

85,00

Corpo a incasso per rubinetto da lavello

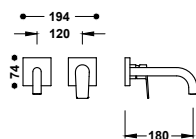

Visible part for recessed sink body

Visible part only. Includes concealing plate, handle and 180 mm spout. Recessed body not included.

Elemento a vista per il corpo a incasso da lavello

Solo parte a vista. Include piastra decorativa, comando e beccuccio da 180 mm. Corpo a incasso non incluso.



21130021	140,00
21130021NM	217,00
21130021BM	217,00
21130021AC	217,00
21130021KM	217,00
21130021KMB	217,00
21130021OR	308,00
21130021OM	308,00
21130021OP	308,00
21130021OPM	308,00



Recessed body for sink tap

20830002

85,00

Corpo a incasso per rubinetto da lavello

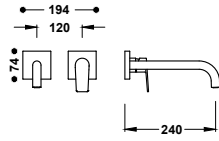

Visible part for recessed sink body

Visible part only. Includes concealing plate, handle and 240 mm spout. Recessed body not included.

Elemento a vista per il corpo a incasso da lavello

Solo parte a vista. Include piastra decorativa, comando e beccuccio da 240 mm. Corpo a incasso non incluso.



21130022	150,00
21130022NM	233,00
21130022BM	233,00
21130022AC	233,00
21130022KM	233,00
21130022KMB	233,00
21130022OR	330,00
21130022OM	330,00
21130022OP	330,00
21130022OPM	330,00



Recessed body for sink tap

20830002 85,00

Corpo a incasso per rubinetto da lavello

BIDET TAPS / RUBINETTI PER BIDET

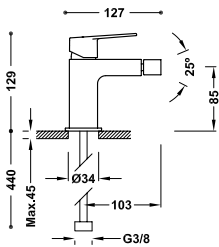

Single-handle bidet mixer tap

Adjustable shower head. G3/8 flexible hoses.

Miscelatore monocomando per bidet

Supporto orientabile. Flessibili di alimentazione G3/8.



21112001	114,00
21112001D	138,00
21112001NM	177,00
21112001BM	177,00
21112001AC	177,00
21112001KM	177,00
21112001KMB	177,00
21112001OR	252,00
21112001OM	252,00
21112001OP	252,00
21112001OPM	252,00

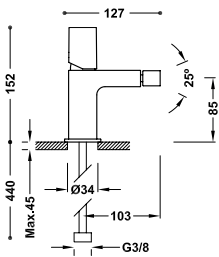

Single-handle bidet mixer tap

Adjustable shower head. G3/8 flexible hoses.

Miscelatore monocomando per bidet

Supporto orientabile. Flessibili di alimentazione G3/8.



21112002	114,00
21112002D	138,00
21112002NM	177,00
21112002BM	177,00
21112002AC	177,00
21112002KM	177,00
21112002KMB	177,00
21112002OR	252,00
21112002OM	252,00
21112002OP	252,00
21112002OPM	252,00

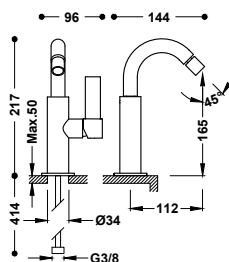

Single-handle bidet mixer tap with lateral lever

Adjustable shower head. G3/8 flexible hoses.

Miscelatore monocomando con leva laterale per bidet

Supporto orientabile. Flessibili di alimentazione G3/8.



21122401	200,00
21122401NM	309,00
21122401BM	309,00
21122401AC	309,00
21122401KM	309,00
21122401KMB	309,00
21122401OR	439,00
21122401OM	439,00
21122401OP	439,00
21122401OPM	439,00

WALL TAPS / RUBINETTI A MURO

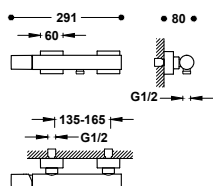

Wall-mounted single-handle shower mixer tap

Anti-limescale brass hand shower. Adjustable support for hand shower. Satin hose.

Miscelatore monocomando a muro per doccia

Doccino anticalcare in ottone. Supporto orientabile per doccino. Flessibile satinato.

21116701	231,00
21116701NM	358,00
21116701BM	358,00
21116701AC	358,00
21116701KM	358,00
21116701KMB	358,00
21116701OR	508,00
21116701OM	508,00
21116701OP	508,00
21116701OPM	508,00

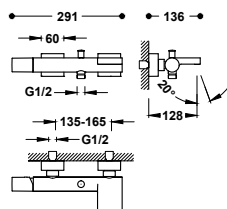

Wall-mounted single-handle mixer tap for bath and shower

With cascade outlet. Anti-limescale brass hand shower. Adjustable support for hand shower. Satin hose.

Miscelatore monocomando a muro per vasca e doccia

Con getto a cascata. Doccino anticalcare in ottone. Supporto orientabile per doccino. Flessibile satinato.

21117001	252,00
21117001NM	391,00
21117001BM	391,00
21117001AC	391,00
21117001KM	391,00
21117001KMB	391,00
21117001OR	554,00
21117001OM	554,00
21117001OP	554,00
21117001OPM	554,00



CONCEALED TAPS/ RUBINETTI DA INCASSO

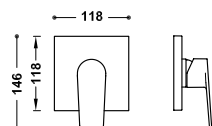

Visible part for concealed 1-way Rapid-box

Only visible part. Includes trim plate, control, bush and concealed attachment screw. Complete with concealed Rapid-box ref.: 20827810.

Pezzo vista per cassa da incasso a 1 via Rapid-box

Solo parte vista. Include piastra decorativa, comando, boccia e vite di fissaggio occulta. Completare con scatola da incasso Rapid-box rif.: 20827810.

21127810	79,00
21127810NM	122,00
21127810BM	122,00
21127810AC	122,00
21127810KM	122,00
21127810KMB	122,00
21127810OR	173,00
21127810OM	173,00
21127810OP	173,00
21127810OPM	173,00



Concealed 1-way Rapid-box with single-handle mixer tap for shower

20827810	80,00
----------	-------

Scatola da incasso a 1 via Rapid-box con miscelatore monocomando per doccia

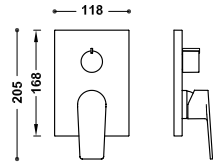

Visible part for concealed 2-way Rapid-box

Only visible part. Includes trim plate, control, distribution handle and concealed attachment screw. Complete with concealed Rapid-box ref: 20828110.

Pezzo vista per cassa da incasso a 2 vie Rapid-box

Solo parte vista. Include piastra decorativa, comando, volante distributore e vite di fissaggio occulta. Completare con scatola da incasso Rapid-box rif: 20828110.

21128110	100,00
21128110NM	155,00
21128110BM	155,00
21128110AC	155,00
21128110KM	155,00
21128110KMB	155,00
21128110OR	219,00
21128110OM	219,00
21128110OP	219,00
21128110OPM	219,00



Concealed 2-way Rapid-box with single-handle mixer tap for shower and bath

20828110 90,00

Scatola da incasso a 2 vie Rapid-box con miscelatore monocomando per doccia e vasca da bagno

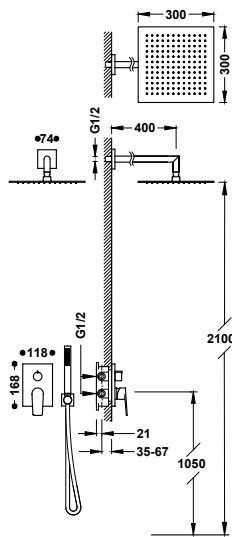

Rapid-box 2-way concealed single-handle shower mixer tap kit

- Concealed body included.
- 2-way ceramic distributor.
- Wall-mounted arm with adjustable stainless steel shower head: 300x300 mm.
- Wall-mounted support for hand shower with water supply.
- Anti-limescale brass hand shower.
- Satin hose.

Kit di miscelatore monocomando a incasso 2 getti Rapid-box per doccia

- Corpo a incasso incluso.
- Erogatore in ceramica a 2 getti.
- Braccio a muro con soffione doccia orientabile in acciaio inossidabile: 300x300 mm.
- Supporto per doccia con presa d'acqua a muro.
- Doccino anticalcare in ottone.
- Flessibile satinato.

21128004	540,00
21128004NM	787,00
21128004BM	787,00
21128004AC	787,00
21128004KM	787,00
21128004KMB	787,00
21128004OR	1.081,00
21128004OM	1.081,00
21128004OP	1.081,00
21128004OPM	1.081,00

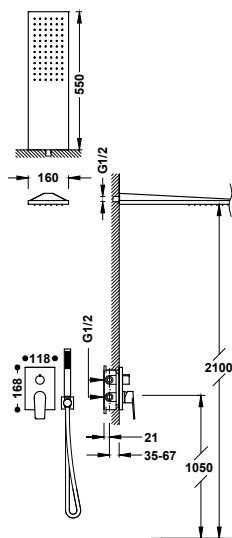
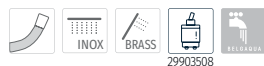

Rapid-box 2-way concealed single-handle shower mixer tap kit

- Concealed body included.
- 2-way ceramic distributor.
- Stainless steel wall-mounted shower head: 160x550 mm.
- Wall-mounted support for hand shower with water supply.
- Anti-limescale brass hand shower.
- Satin hose.

Kit di miscelatore monocomando a incasso 2 getti Rapid-box per doccia

- Corpo a incasso incluso.
- Erogatore in ceramica a 2 getti.
- Soffione doccia a muro in acciaio inossidabile: 160x550 mm.
- Supporto per doccia con presa d'acqua a muro.
- Doccino anticalcare in ottone.
- Flessibile satinato.

21128005	731,00
21128005NM	1.085,00
21128005BM	1.085,00
21128005AC	1.085,00
21128005KM	1.085,00
21128005KMB	1.085,00
21128005OR	1.504,00
21128005OM	1.504,00
21128005OP	1.504,00
21128005OPM	1.504,00

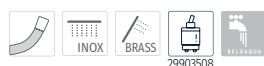

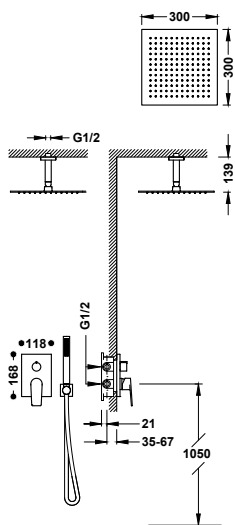

Rapid-box 2-way concealed single-handle shower mixer tap kit

- Concealed body included.
- 2-way ceramic distributor.
- Ceiling-mounted arm with adjustable stainless steel shower head: 300x300 mm.
- Wall-mounted support for hand shower with water supply.
- Anti-limescale brass hand shower.
- Satin hose.

Kit di miscelatore monocomando a incasso 2 getti Rapid-box per doccia

- Corpo a incasso incluso.
- Erogatore in ceramica a 2 getti.
- Braccio a soffitto con soffione doccia orientabile in acciaio inossidabile: 300x300 mm.
- Supporto per doccia con presa d'acqua a muro.
- Doccino anticalcare in ottone.
- Flessibile satinato.

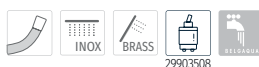

21128003	506,00
21128003NM	735,00
21128003BM	735,00
21128003AC	735,00
21128003KM	735,00
21128003KMB	735,00
21128003OR	1.007,00
21128003OM	1.007,00
21128003OP	1.007,00
21128003OPM	1.007,00

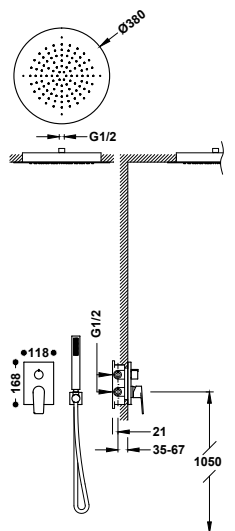

Rapid-box 2-way concealed single-handle shower mixer tap kit

- Concealed body included.
- 2-way ceramic distributor.
- Concealed stainless steel ceiling-mounted shower head: Ø 380 mm.
- Wall-mounted support for hand shower with water supply.
- Anti-limescale brass hand shower.
- Satin hose.

Kit di miscelatore monocomando a incasso 2 getti Rapid-box per doccia

- Corpo a incasso incluso.
- Erogatore in ceramica a 2 getti.
- Soffione doccia soffitto a incasso in acciaio inossidabile: Ø 380 mm.
- Supporto per doccia con presa d'acqua a muro.
- Doccino anticalcare in ottone.
- Flessibile satinato.

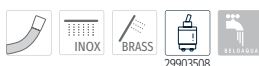

21128006	1.086,00
21128006NM	1.634,00
21128006BM	1.634,00
21128006AC	1.634,00
21128006KM	1.634,00
21128006KMB	1.634,00
21128006OR	2.282,00
21128006OM	2.282,00
21128006OP	2.282,00
21128006OPM	2.282,00

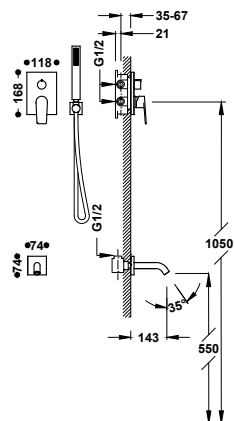

Rapid-box 2-way concealed single-handle mixer tap kit for bath and shower

- Concealed body included.
- 2-way ceramic distributor.
- Fixed wall-mounted spout.
- Wall-mounted support for hand shower with water supply.
- Anti-limescale brass hand shower.
- Satin hose.

Kit di miscelatore monocomando a incasso a 2 getti Rapid-box per vasca e doccia

- Corpo a incasso incluso.
- Erogatore in ceramica a 2 getti.
- Canna fissa a muro.
- Supporto per doccia con presa d'acqua a muro.
- Doccino anticalcare in ottone.
- Flessibile satinato.

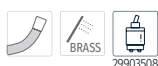

21128007	394,00
21128007NM	560,00
21128007BM	560,00
21128007AC	560,00
21128007KM	560,00
21128007KMB	560,00
21128007OR	758,00
21128007OM	758,00
21128007OP	758,00
21128007OPM	758,00

BATH TAPS / RUBINETTI PER VASCA

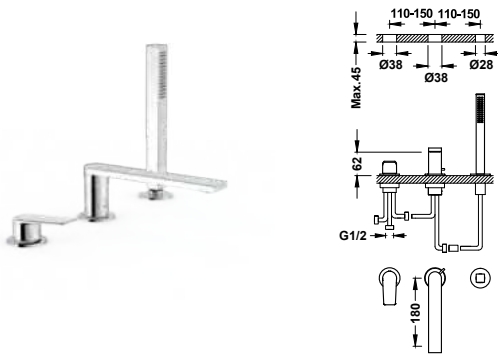

Single-handle bath edge mixer tap

- Inverter integrated into the bath spout.
- Anti-limescale brass hand shower.
- 180 mm bath spout. Water flow: 3 bar - 13 l/min.
- Optional tank kit not included ref.: 20024501.

Miscelatore monocomando bordo vasca

- Inverter incorporato nella canna della vasca.
- Doccino anticalcare in ottone.
- Canna della vasca di 180 mm. Flusso: 3 bar - 13 l/min.
- Kit contenitore opzionale non incluso rif.: 20024501.

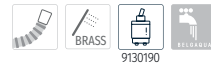

21116101	370,00
21116101NM	574,00
21116101BM	574,00
21116101AC	574,00
21116101KM	574,00
21116101KMB	574,00
21116101OR	814,00
21116101OM	814,00
21116101OP	814,00
21116101OPM	814,00



Tank for bath edge tapware
Contenitore per kit di miscelazione bordo vasca

20024501	415,00
----------	--------



Click-clack drainage valve for bath with overflow and drainage point
Valvola di scarico Click-clack per vasca con troppopieno e presa drenaggio

134445	100,00
--------	--------

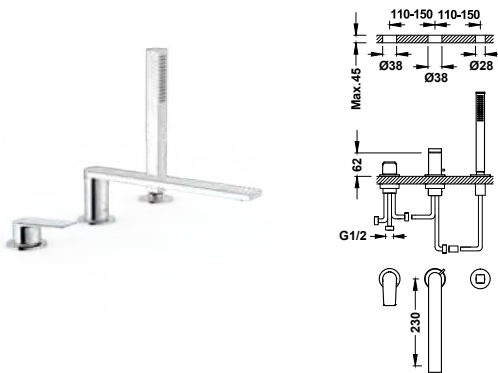

Single-handle bath edge mixer tap

- Inverter integrated into the bath spout.
- Anti-limescale brass hand shower.
- 230 mm bath spout. Water flow: 3 bar - 13 l/min.
- Optional tank kit not included ref.: 20024501.

Miscelatore monocomando bordo vasca

- Inverter incorporato nella canna della vasca.
- Doccino anticalcare in ottone.
- Canna della vasca di 230 mm. Flusso: 3 bar - 13 l/min.
- Kit contenitore opzionale non incluso rif.: 20024501.



21116103	380,00
21116103NM	589,00
21116103BM	589,00
21116103AC	589,00
21116103KM	589,00
21116103KMB	589,00
21116103OR	836,00
21116103OM	836,00
21116103OP	836,00
21116103OPM	836,00



Tank for bath edge tapware
Contenitore per kit di miscelazione bordo vasca

20024501	415,00
----------	--------



Click-clack drainage valve for bath with overflow and drainage point
Valvola di scarico Click-clack per vasca con troppopieno e presa drenaggio

134445	100,00
--------	--------

THERMOSTATIC WALL TAPS / RUBINETTO TERMOSTATICI A MURO

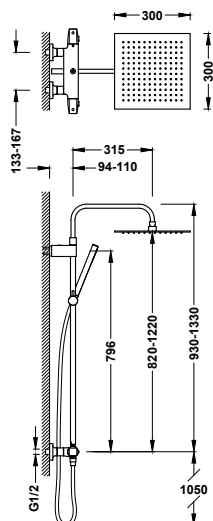

2-way Over-wall thermostatic shower mixer tap set

- With diverter integrated into the flow regulator.
- Square-round handle.
- Telescopic shower bar.
- Stainless steel adjustable shower head: 300x300 mm.
- Adjustable and sliding support for hand shower.
- Anti-limescale brass hand shower.
- Satin hose.

Set di miscelatore termostatico a muro Over-wall 2 getti per doccia

- Con inverter incorporato nel regolatore di flusso.
- Manopola quadrata-rotonda.
- Colonna doccia telescopica.
- Soffione doccia orientabile in acciaio inossidabile: 300x300 mm.
- Supporto scorrevole e orientabile per doccia.
- Doccino anticalcare in ottone.
- Flessibile satinato.



19039307	596,00
19039307NM	924,00
19039307BM	924,00
19039307AC	924,00
19039307KMB	924,00
19039307OM	1.311,00
19039307OPM	1.311,00

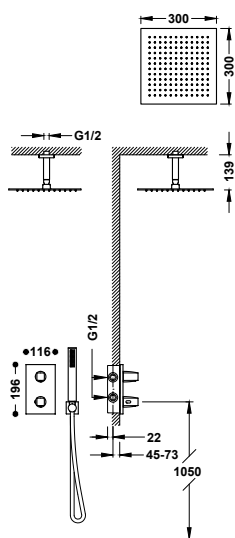

Therm-box 2-way concealed thermostatic tap kit for showers

- Concealed body included.
- Square-round handle with temperature control. 2-way ceramic distributor.
- Ceiling-mounted arm with adjustable stainless steel shower head: 300x300 mm.
- Wall-mounted support for hand shower with water supply.
- Anti-limescale brass hand shower.
- Satin hose.

**Kit di miscelatore termostatico da incasso a 2 getti
Therm-box per doccia**

- Corpo a incasso incluso.
- Manopola quadrata-rotonda con controllo della temperatura.
- Erogatore in ceramica a 2 getti.
- Braccio a soffitto con soffione doccia orientabile in acciaio inossidabile: 300x300 mm.
- Supporto per doccino con presa d'acqua a muro.
- Doccino anticalcare in ottone.
- Flessibile satinato.



21125003	566,00
21125003NM	805,00
21125003BM	805,00
21125003AC	805,00
21125003KM	805,00
21125003KMB	805,00
21125003OR	1.089,00
21125003OM	1.089,00
21125003OP	1.089,00
21125003OPM	1.089,00



MAX

Its careful design, combined with specially created technology, makes Max one of the most elegant and functional series available, providing your bathroom with modernity, simplicity and quality.

La cura estetica unita a tutta la tecnologia sviluppata per la sua creazione collocano Max tra le serie più eleganti e funzionali che apportano modernità, semplicità e qualità al bagno.







WASHBASIN TAPS / RUBINETTI PER LAVABO

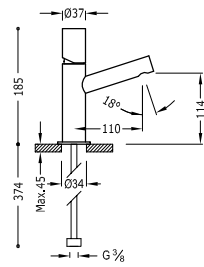

Single-handle washbasin mixer tap

G3/8 flexible shower hose

Miscelatore monocomando per lavabo

Flessibili di alimentazione G3/8

- 06110301 109,00
- 06110301D 132,00

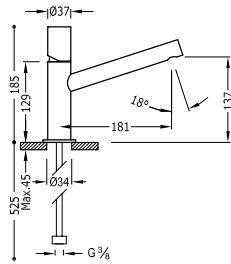

Single-handle washbasin mixer tap

Long spout. G3/8 flexible hoses.

Miscelatore monocomando per lavabo

Canna lunga. Flessibili di alimentazione G3/8.

- 06120301 125,00
- 06120301D 148,00

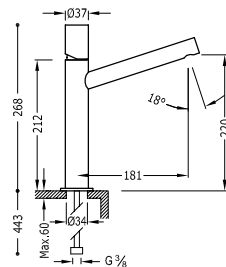

High single-handle washbasin mixer tap

Long spout. G3/8 flexible hoses.

Miscelatore monocomando alto per lavabo

Canna lunga. Flessibili di alimentazione G3/8.

- 06120601 217,00

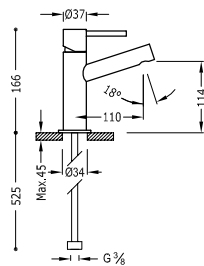

Single-handle washbasin mixer tap

G3/8 flexible hoses.

Miscelatore monocomando per lavabo

Flessibili di alimentazione G3/8.

- 06210301 109,00
- 06210301D 132,00

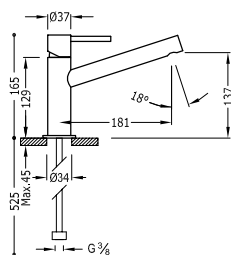

Single-handle washbasin mixer tap

Long spout. G3/8 flexible hoses.

Miscelatore monocomando per lavabo

Canna lunga. Flessibili di alimentazione G3/8.

- 06220301 125,00
- 06220301D 148,00



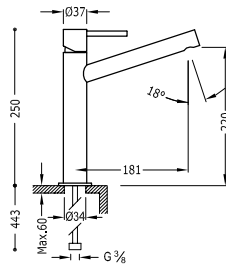

High single-handle washbasin mixer tap

Long spout. G3/8 flexible hoses.

Miscelatore monocomando alto per lavabo

Canna lunga. Flessibili di alimentazione G3/8.

06220601

217,00



910719005

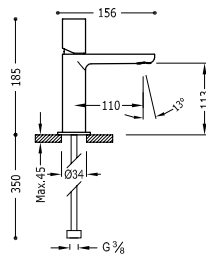

Single-handle washbasin mixer tap

G3/8 flexible hoses.

Miscelatore monocomando per lavabo

Flessibili di alimentazione G3/8.

06110302

127,00

06110302D

150,00



9130190

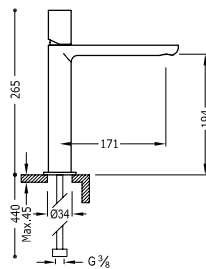

High single-handle washbasin mixer tap

G3/8 flexible hoses.

Miscelatore monocomando alto per lavabo

Flessibili di alimentazione G3/8.

06120304

217,00



9130190

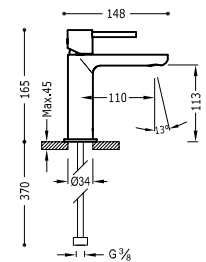

Single-handle washbasin mixer tap

G3/8 flexible hoses.

Miscelatore monocomando per lavabo

Flessibili di alimentazione G3/8.

06210302

127,00

06210302D

150,00



9130190

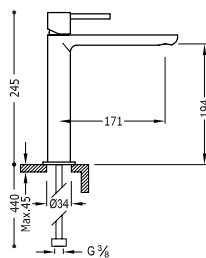

High single-handle washbasin mixer tap

G3/8 flexible hoses.

Miscelatore monocomando alto per lavabo

Flessibili di alimentazione G3/8.

06220304

217,00



9130190

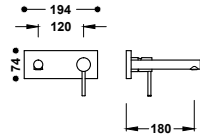

Visible part for recessed sink body

06230031

155,00

Visible part only. Includes concealing plate, handle and 180 mm spout. Recessed body not included.

Elemento a vista per il corpo a incasso da lavello

Solo parte a vista. Include piastra decorativa, comando e beccuccio da 180 mm. Corpo a incasso non incluso.



Recessed body for sink tap

20830002

85,00

Corpo a incasso per rubinetto da lavello

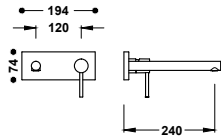

Visible part for recessed sink body

06230032

165,00

Visible part only. Includes concealing plate, handle and 240 mm spout. Recessed body not included.

Elemento a vista per il corpo a incasso da lavello

Solo parte a vista. Include piastra decorativa, comando e beccuccio da 240 mm. Corpo a incasso non incluso.



Recessed body for sink tap

20830002

85,00

Corpo a incasso per rubinetto da lavello

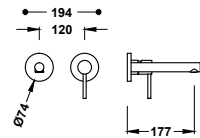

Visible part for recessed sink body

06230021

135,00

Visible part only. Includes concealing plate, handle and 177 mm spout. Recessed body not included.

Elemento a vista per il corpo a incasso da lavello

Solo parte a vista. Include piastra decorativa, comando e beccuccio da 177 mm. Corpo a incasso non incluso.



Recessed body for sink tap

20830002

85,00

Corpo a incasso per rubinetto da lavello

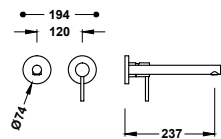

Visible part for recessed sink body

06230022

145,00

Visible part only. Includes concealing plate, handle and 237 mm spout. Recessed body not included.

Elemento a vista per il corpo a incasso da lavello

Solo parte a vista. Include piastra decorativa, comando e beccuccio da 237 mm. Corpo a incasso non incluso.



Recessed body for sink tap

20830002

85,00

Corpo a incasso per rubinetto da lavello

BIDET TAPS / RUBINETTI PER BIDET

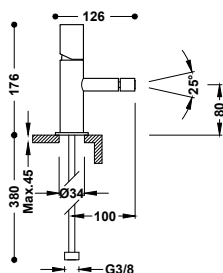

Single-handle bidet mixer tap

Adjustable shower head. G3/8 flexible hoses.

06112001 112,00

06112001D 135,00

Miscelatore monocomando per bidet

Supporto orientabile. Flessibili di alimentazione G3/8.



910719005

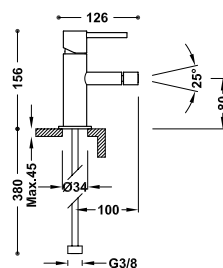

Single-handle bidet mixer tap

Adjustable shower head. G3/8 flexible hoses.

06212001 112,00

06212001D 135,00

Miscelatore monocomando per bidet

Supporto orientabile. Flessibili di alimentazione G3/8.



910719005

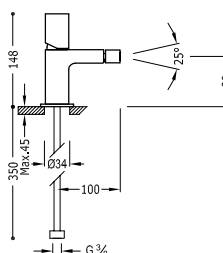

Single-handle bidet mixer tap

Adjustable shower head. G3/8 flexible hoses.

06222001 130,00

06222001D 153,00

Miscelatore monocomando per bidet

Supporto orientabile. Flessibili di alimentazione G3/8.



9130190

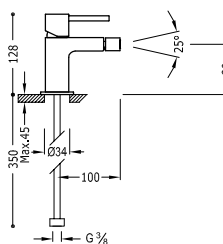

Single-handle bidet mixer tap

Adjustable shower head. G3/8 flexible hoses.

06222001 130,00

06222001D 153,00

Miscelatore monocomando per bidet

Supporto orientabile. Flessibili di alimentazione G3/8.



9130190

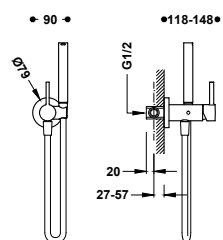

Concealed single lever WC/ bidet mixer

With cold and hot water. Hand shower with 5 l/min limiter coupling and non-drip system. Fixed support for hand shower for installation on right or left. Satin hose.

134123 190,00

Miscelatore monocomando con doccia per wc

Con acqua fredda e calda. Doccino con limitatore a 5 l/min. e sistema antigocciolamento. Supporto fisso per doccia installabile a destra o a sinistra. Flessibile satinato.



9134591

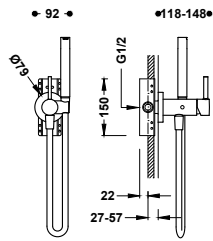

Concealed single lever WC/ bidet mixer

134122

230,00

Option for plasterboard walls. With cold and hot water. Hand shower with 5 l/min limiter coupling and non-drip system. Fixed support for hand shower for installation on right or left. Satin hose.

Miscelatore monocomando con doccino per wc

Opzione per pareti in cartongesso. Con acqua fredda e calda. Doccino con limitatore a 5 l/min. e sistema antigocciolamento. Supporto fisso per doccino installabile a destra o a sinistra. Flessibile satinato.



Towel holder accessory for toilet mixer tap with shower

03412401

37,00

Installable support for right or left side (for ref.: 134122, 134123, 181122, 181123, 181222, 181223, 20522201, 20522301). Length: 180 mm.

Portasciugamano per rubinetto con doccino per wc

Supporto installabile a destra o a sinistra (per rif.: 134122, 134123, 181122, 181123, 181222, 181223, 20522201, 20522301). Lungh.: 180 mm.

WALL TAPS / RUBINETTI A MURO

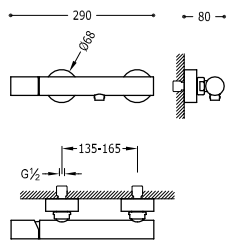

Wall-mounted single-handle shower mixer tap

06116701

215,00

Anti-limescale hand shower. Adjustable support for hand shower. Satin hose.

Miscelatore monocomando a muro per doccia

Doccino anticalcare. Supporto orientabile per doccino. Flessibile satinato.

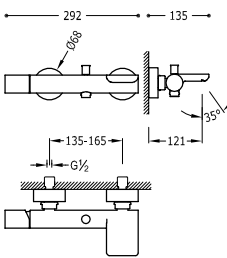

Wall-mounted single-handle mixer tap for bath and shower

06117001

236,00

Anti-limescale hand shower. Closed spout with cascade outlet. Adjustable support for hand shower. Satin hose.

Miscelatore monocomando a muro per vasca e doccia

Doccino anticalcare. Canna chiusa con getto a cascata. Supporto orientabile per doccino. Flessibile satinato.

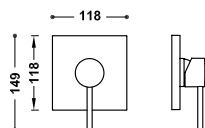

CONCEALED TAPS/ RUBINETTI DA INCASSO

**Visible part for concealed 1-way Rapid-box**

06227810

79,00

Only visible part. Includes trim plate, control, bush and concealed attachment screw. Complete with concealed Rapid-box ref.: 20827810.

Pezzo vista per cassa da incasso a 1 via Rapid-box

Solo parte vista. Include piastra decorativa, comando, boccola e vite di fissaggio occulta. Completare con scatola da incasso Rapid-box rif.: 20827810.



Concealed 1-way Rapid-box with single-handle mixer tap for shower

20827810

80,00

Scatola da incasso a 1 via Rapid-box con miscelatore monocomando per doccia

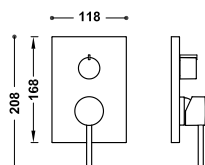
**Visible part for concealed 2-way Rapid-box**

06228110

100,00

Only visible part. Includes trim plate, control, distribution handle and concealed attachment screw. Complete with concealed Rapid-box ref.: 20828110.

Pezzo vista per cassa da incasso a 2 vie Rapid-box

Solo parte vista. Include piastra decorativa, comando, volante distributore e vite di fissaggio occulta. Completare con scatola da incasso Rapid-box rif.: 20828110.



Concealed 2-way Rapid-box with single-handle mixer tap for shower and bath

20828110

90,00

Scatola da incasso a 2 vie Rapid-box con miscelatore monocomando per doccia e vasca da bagno

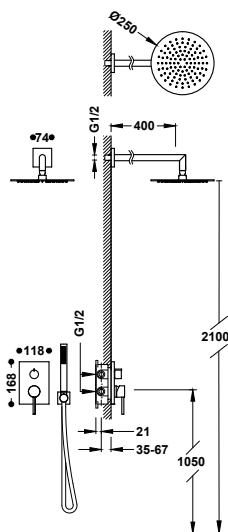
**Rapid-box 2-way concealed single-handle shower mixer tap kit**

06228004

427,00

- Concealed body included.
- 2-way ceramic distributor.
- Wall-mounted arm with adjustable stainless steel shower head: \varnothing 250 mm.
- Wall-mounted support for hand shower with water supply.
- Anti-limescale brass hand shower.
- Satin hose.

Kit di miscelatore monocomando a incasso 2 getti Rapid-box per doccia

- Corpo a incasso incluso.
- Erogatore in ceramica a 2 getti.
- Braccio a muro con soffione doccia orientabile in acciaio inossidabile: \varnothing 250 mm.
- Supporto per doccia con presa d'acqua a muro.
- Doccino anticalcare in ottone.
- Flessibile satinato.



29903508

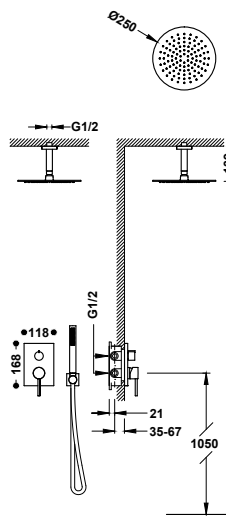

Rapid-box 2-way concealed single-handle shower mixer tap kit

06228003

387,00

- Concealed body included.
- 2-way ceramic distributor.
- Ceiling-mounted arm with adjustable stainless steel shower head: Ø 250 mm.
- Wall-mounted support for hand shower with water supply.
- Anti-limescale brass hand shower.
- Satin hose.

Kit di miscelatore monocomando a incasso 2 getti Rapid-box per doccia

- Corpo a incasso incluso.
- Erogatore in ceramica a 2 getti.
- Braccio a soffitto con soffione doccia orientabile in acciaio inossidabile: Ø 250 mm.
- Supporto per doccia con presa d'acqua a muro.
- Doccino anticalcare in ottone.
- Flessibile satinato.

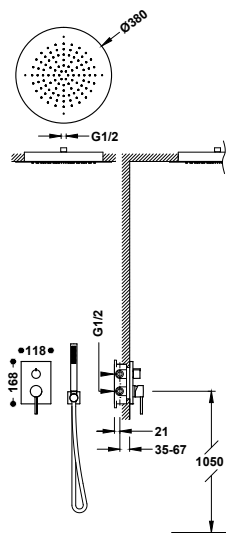

Rapid-box 2-way concealed single-handle shower mixer tap kit

06228005

888,00

- Concealed body included.
- 2-way ceramic distributor.
- Concealed stainless steel ceiling-mounted shower head: Ø 380 mm.
- Wall-mounted support for hand shower with water supply.
- Anti-limescale brass hand shower.
- Satin hose.

Kit di miscelatore monocomando a incasso 2 getti Rapid-box per doccia

- Corpo a incasso incluso.
- Erogatore in ceramica a 2 getti.
- Soffione da soffitto a incasso in acciaio inossidabile: Ø 380 mm.
- Supporto per doccia con presa d'acqua a muro.
- Doccino anticalcare in ottone.
- Flessibile satinato.

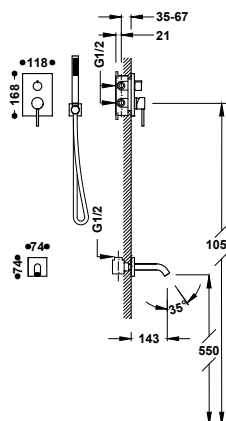

Rapid-box 2-way concealed single-handle mixer tap kit for bath and shower

06228006

335,00

- Concealed body included.
- 2-way ceramic distributor.
- Fixed wall-mounted spout.
- Wall-mounted support for hand shower with water supply.
- Anti-limescale brass hand shower.
- Satin hose.

Kit di miscelatore monocomando a incasso a 2 getti Rapid-box per vasca e doccia

- Corpo a incasso incluso.
- Erogatore in ceramica a 2 getti.
- Canna fissa a muro.
- Supporto per doccia con presa d'acqua a muro.
- Doccino anticalcare in ottone.
- Flessibile satinato.

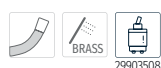

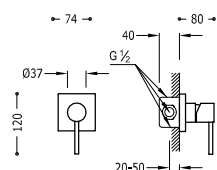
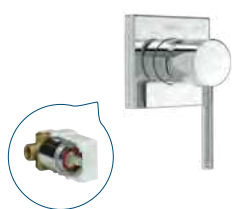

1-way concealed single-handle shower mixer tap

06217702

116,00

Concealed body included. With lever. 2-way diverter.

Miscelatore monocomando a incasso 1 getto per doccia

Corpo a incasso incluso.



9130190

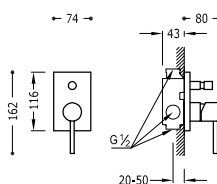

2-way concealed single-handle shower mixer tap

06218002

179,00

Concealed body included. 2-way diverter.

Miscelatore monocomando a incasso 2 getti per doccia

Corpo a incasso incluso. Inverter a 2 getti.



9130190

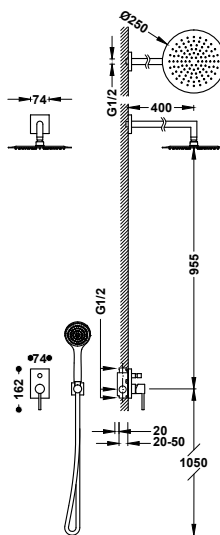

2-way concealed single-handle shower mixer tap kit

06298004

442,00

- Concealed body included.
- 2-way diverter.
- Wall-mounted arm with adjustable stainless steel shower head: \varnothing 250 mm.
- Wall-mounted support for hand shower with water supply.
- Anti-limescale hand shower.
- Satin hose.

Kit di miscelatore monocomando a incasso 2 getti per doccia

- Corpo a incasso incluso.
- Inverter a 2 getti.
- Braccio a muro con soffione doccia orientabile in acciaio inossidabile: \varnothing 250 mm.
- Supporto per doccia con presa d'acqua a muro.
- Doccino anticalcare.
- Flessibile satinato.



9130190

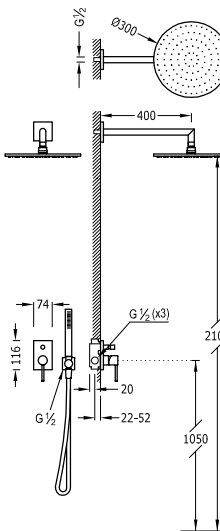

2-way concealed single-handle shower mixer tap kit

06298001

513,00

- Concealed body included.
- 2-way diverter.
- Wall-mounted arm with adjustable stainless steel shower head: \varnothing 300 mm.
- Wall-mounted support for hand shower with water supply.
- Anti-limescale brass hand shower.
- Satin hose.

Kit di miscelatore monocomando a incasso 2 getti per doccia

- Corpo a incasso incluso.
- Inverter a 2 getti.
- Braccio a muro con soffione doccia orientabile in acciaio inossidabile: \varnothing 300 mm.
- Supporto per doccia con presa d'acqua a muro.
- Doccino anticalcare in ottone.
- Flessibile satinato.

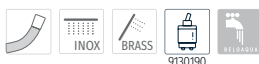

9130190

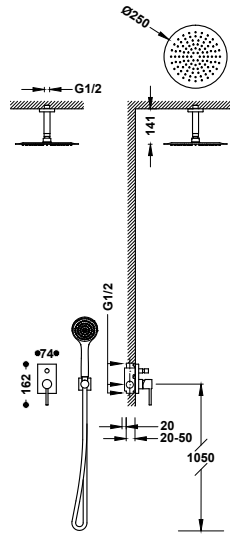

2-way concealed single-handle shower mixer tap kit

06218081

414,00

- Concealed body included.
- 2-way diverter.
- Ceiling-mounted arm with adjustable stainless steel shower head: Ø 250 mm.
- Wall-mounted support for hand shower with water supply.
- Anti-limescale hand shower.
- Satin hose.

Kit di miscelatore monocomando a incasso 2 getti per doccia

- Corpo a incasso incluso.
- Inverter a 2 getti.
- Braccio a soffitto con soffione doccia orientabile in acciaio inossidabile: Ø 250 mm.
- Supporto per doccia con presa d'acqua a muro.
- Doccino anticalcare.
- Flessibile satinato.

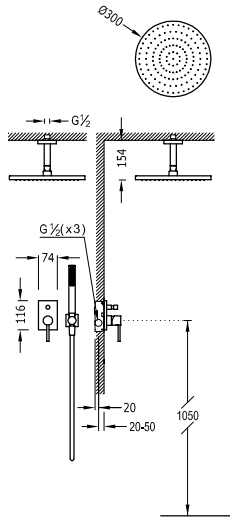

2-way concealed single-handle shower mixer tap kit

06218080

479,00

- Concealed body included.
- 2-way diverter.
- Ceiling-mounted arm with adjustable stainless steel shower head: Ø 300 mm.
- Wall-mounted support for hand shower with water supply.
- Anti-limescale brass hand shower.
- Satin hose.

Kit di miscelatore monocomando a incasso 2 getti per doccia

- Corpo a incasso incluso.
- Inverter a 2 getti.
- Braccio a soffitto con soffione doccia orientabile in acciaio inossidabile: Ø 300 mm.
- Supporto per doccia con presa d'acqua a muro.
- Doccino anticalcare in ottone.
- Flessibile satinato.

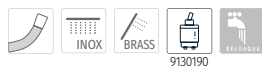

BATH TAPS / RUBINETTI PER VASCA

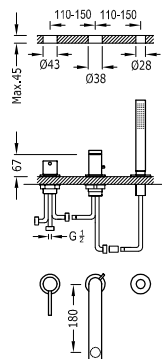

Single-handle bath edge mixer tap

06216103

350,00

- Inverter integrated into the bath spout.
- Anti-limescale brass hand shower.
- 180 mm bath spout. Water flow: 3 bar - 16 l/min.
- Optional tank kit not included ref.: 20324501.

Miscelatore monocomando bordo vasca

- Inverter incorporato nella canna della vasca.
- Doccino anticalcare in ottone.
- Canna della vasca di 180 mm. Flusso: 3 bar - 16 l/m.
- Kit contenitore opzionale non incluso rif: 20324501.



Tank for bath edge tapware
Contenitore per kit di miscelazione bordo vasca

20324501

415,00

Click-clack drainage valve for bath with overflow and drainage point
Valvola di scarico Click-clack per vasca con troppopieno e presa drenaggio

134445

100,00

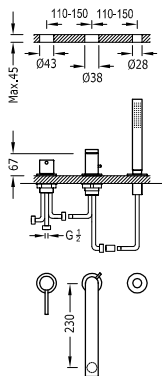

Single-handle bath edge mixer tap

06216102 360,00

- Inverter integrated into the bath spout.
- Anti-limescale brass hand shower.
- 230 mm bath spout. Water flow: 3 bar - 16 l/min.
- Optional tank kit not included ref.: 20324501.

Miscelatore monocomando bordo vasca

- *Inverter incorporato nella canna della vasca.*
- *Doccino anticalcare in ottone.*
- *Canna della vasca di 230 mm. Flusso: 3 bar - 16 l/m.*
- *Kit contenitore opzionale non incluso rif: 20324501.*



Tank for bath edge tapware
Contenitore per kit di miscelazione bordo vasca

20324501 415,00



Click-clack drainage valve for bath with overflow and drainage point
Valvola di scarico Click-clack per vasca con troppopieno e presa drenaggio

134445 100,00

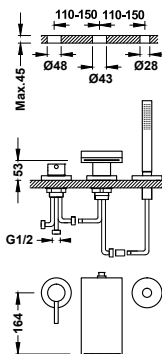

Single-handle bath edge mixer tap

162161 790,00

- Inverter integrated into the bath spout.
- Anti-limescale brass hand shower.
- Bath spout with cascade outlet. Water flow: 3 bar - 17 l/min.
- Optional tank kit not included ref.: 162245.

Miscelatore monocomando bordo vasca

- *Inverter incorporato nella canna della vasca.*
- *Doccino anticalcare in ottone.*
- *Canna della vasca con getto a cascata. Flusso: 3 bar - 17 l/m.*
- *Kit contenitore opzionale non incluso rif: 162245.*



Tank for bath edge tapware
Contenitore per kit di miscelazione bordo vasca

162245 415,00



Click-clack drainage valve for bath with overflow and drainage point

134445 100,00

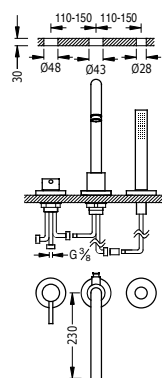

Single-handle bath edge mixer tap

26215001 450,00

- Inverter integrated into the bath spout.
- Anti-limescale brass hand shower.
- Water flow: 3 bar - 14 l/min.
- Optional tank kit not included ref.: 162245.

Miscelatore monocomando bordo vasca

- *Inverter incorporato nella canna della vasca.*
- *Doccino anticalcare in ottone.*
- *Flusso: 3 bar - 14 l/min.*
- *Kit contenitore opzionale non incluso rif: 162245.*



Tank for bath edge tapware
Contenitore per kit di miscelazione bordo vasca

162245 415,00



Click-clack drainage valve for bath with overflow and drainage point
Valvola di scarico Click-clack per vasca con troppopieno e presa drenaggio

134445 100,00

THERMOSTATIC WALL TAPS / RUBINETTO TERMOSTATICI A MURO

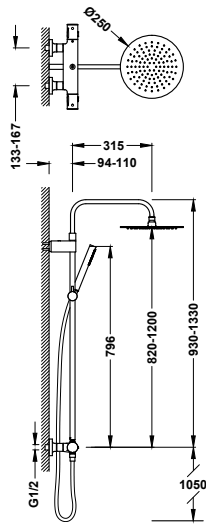

2-way Over-wall thermostatic shower mixer tap set

19038708

489,00

- With diverter integrated into the flow regulator.
- Telescopic shower bar.
- Round handle.
- Stainless steel adjustable shower head: 300x300 mm.
- Adjustable and sliding support for hand shower.
- Anti-limescale brass hand shower.
- Satin hose.

Set di miscelatore termostatico a muro Over-wall 2 getti per doccia

- Con inverter incorporato nel regolatore di flusso.
- Colonna doccia telescopica.
- Manopola rotonda.
- Soffione doccia orientabile in acciaio inossidabile: 300x300 mm.
- Supporto scorrevole e orientabile per doccia.
- Doccino anticalcare in ottone.
- Flessibile satinato.

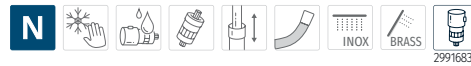

THERMOSTATIC CONCEALED TAPS / RUBINETTI TERMOSTATICI DA INCASSO

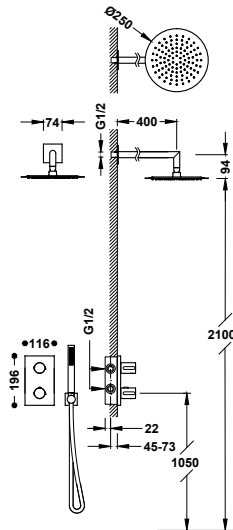

Therm-box 2-way concealed thermostatic tap kit for showers

06225004

515,00

- Concealed body included.
- Round handle with temperature control. 2-way ceramic distributor.
- Wall-mounted arm with adjustable stainless steel shower head: Ø 250 mm.
- Wall-mounted support for hand shower with water supply.
- Anti-limescale brass hand shower.
- Satin hose.

Kit di miscelatore termostatico da incasso a 2 getti Therm-box per doccia

- Corpo a incasso incluso.
- Manopola rotonda con controllo della temperatura. Erogatore in ceramica a 2 getti.
- Braccio a muro con soffione doccia orientabile in acciaio inossidabile: Ø 250 mm.
- Supporto per doccia con presa d'acqua a muro.
- Doccino anticalcare in ottone.
- Flessibile satinato.

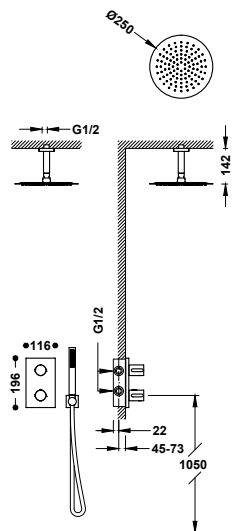

Therm-box 2-way concealed thermostatic tap kit for showers

06225003

480,00

- Concealed body included.
- Round handle with temperature control. 2-way ceramic distributor.
- Ceiling-mounted arm with adjustable stainless steel shower head: Ø 250 mm.
- Wall-mounted support for hand shower with water supply.
- Anti-limescale brass hand shower.
- Satin hose.

Kit di miscelatore termostatico da incasso a 2 getti Therm-box per doccia

- Corpo a incasso incluso.
- Manopola rotonda con controllo della temperatura. Erogatore in ceramica a 2 getti.
- Braccio a soffitto con soffione doccia orientabile in acciaio inossidabile: Ø 250 mm.
- Supporto per doccia con presa d'acqua a muro.
- Doccino anticalcare in ottone.
- Flessibile satinato.





LEX-ALP

A classic design that oozes tranquillity. Lex-Alp is a well-balanced range which works perfectly and never goes out of fashion. That's what makes it special.

Un design classico che invita alla calma. Lex-Alp è una serie equilibrata, che funziona perfettamente e non passa mai di moda. È proprio questo che la rende speciale.







WASHBASIN TAPS / RUBINETTI PER LAVABO

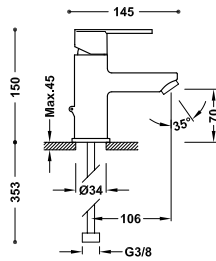

Single-handle washbasin mixer tap

With easy-clean aerator. G3/8 flexible hoses.

■	181103	109,00
■	186103	132,00

Miscelatore monocomando per lavabo

Con aeratore facile da pulire. Flessibili di alimentazione G3/8.

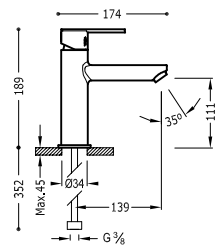

Single-handle washbasin mixer tap

With easy-clean aerator. G3/8 flexible hoses.

■	181203	135,00
■	186203	159,00

Miscelatore monocomando per lavabo

Con aeratore facile da pulire. Flessibili di alimentazione G3/8.

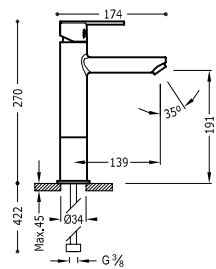

High single-handle washbasin mixer tap

With easy-clean aerator. G3/8 flexible hoses.

■	181217	214,00
■	186217	237,00

Miscelatore monocomando alto per lavabo

Con aeratore facile da pulire. Flessibili di alimentazione G3/8.

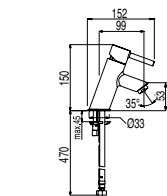

Inclined single-handle washbasin mixer tap

G3/8 flexible hoses.

■	20310301	88,00
■	20310301D	111,00

Miscelatore monocomando inclinato per lavabo

Flessibili di alimentazione G3/8.

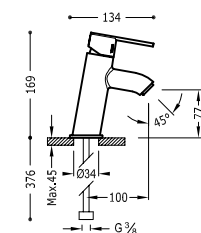

Inclined single-handle washbasin mixer tap

With easy-clean aerator. G3/8 flexible hoses.

■	181903	113,00
---	--------	--------

Miscelatore monocomando inclinato per lavabo

Con aeratore facile da pulire. Flessibili di alimentazione G3/8.



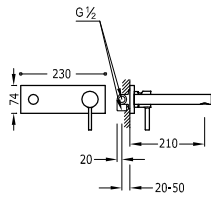

Concealed single-handle washbasin mixer tap

20320002

252,00

Fitted and indivisible body included. 210 mm spout.

Miscelatore monocomando a incasso per lavabo

Corpo a incasso incluso e indivisibile. Canna da 210 mm.



9134592

BIDET TAPS / RUBINETTI PER BIDET

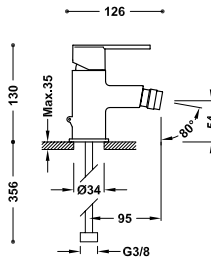

Single-handle bidet mixer tap

181120

112,00

Adjustable shower head. With easy-clean aerator. G3/8 flexible hoses.

186120

135,00

Miscelatore monocomando per bidet

Supporto orientabile. Con aeratore facile da pulire. Flessibili di alimentazione G3/8.



9134592



IA

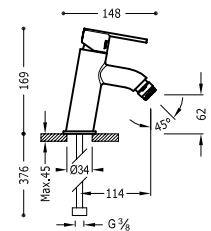

Inclined single-handle bidet mixer tap

181920

117,00

Adjustable shower head. With easy-clean aerator. G3/8 flexible hoses.

186920

140,00

Miscelatore monocomando inclinato per bidet

Supporto orientabile. Con aeratore facile da pulire. Flessibili di alimentazione G3/8.



9134592

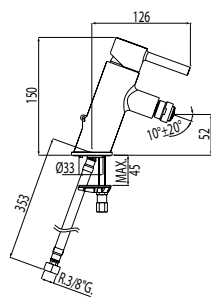

Inclined single-handle bidet mixer tap

20312001

91,00

Adjustable shower head. G3/8 flexible hoses.

Miscelatore monocomando inclinato per bidet

Supporto orientabile. Flessibili di alimentazione G3/8.



9134592



IB

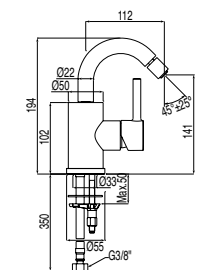

Single-handle bidet mixer tap with lateral lever

20322401

171,00

Adjustable shower head. G3/8 flexible hoses.

Miscelatore monocomando con leva laterale per bidet

Supporto orientabile. Flessibili di alimentazione G3/8.



9134592



360°



9134592

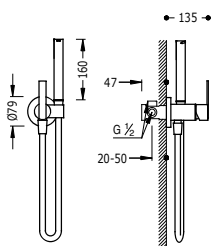

Concealed single lever WC/ bidet mixer

181223

182,00

With cold and hot water. Hand shower with 5 l/min limiter coupling and non-drip system. Fixed support for hand shower for installation on right or left. Satin hose.

Miscelatore monocomando con doccia per wc

Con acqua fredda e calda. Doccino con limitatore a 5 l/min. e sistema antigocciolamento. Supporto fisso per doccia installabile a destra o a sinistra. Flessibile satinato.



9134591

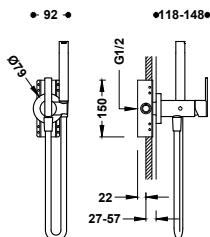

Concealed single lever WC/ bidet mixer

181222

227,00

Option for plasterboard walls. With cold or hot water. Hand shower with 5 l/min limiter coupling and non-drip system. Fixed support for hand shower for installation on right or left. Satin hose.

Miscelatore monocomando con doccia per wc

Opzione per pareti in cartongesso. Con acqua fredda o calda. Doccino con limitatore a 5 l/min. e sistema antigocciolamento. Supporto fisso per doccia installabile a destra o a sinistra. Flessibile satinato.



9134591



Towel holder accessory for toilet mixer tap with shower

03412401

37,00

Installable support for right or left side (for ref: 134122, 134123, 181122, 181123, 181222, 181223, 20522201, 20522301). Length: 180 mm.

Portasciugamano per rubinetto con doccia per wc

Supporto installabile a destra o a sinistra (per rif: 134122, 134123, 181122, 181123, 181222, 181223, 20522201, 20522301). Lunghezza: 180 mm.

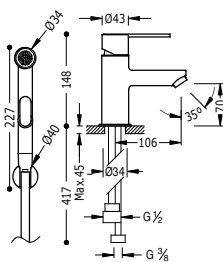

Single-handle mixer tap for toilet with shower

181113

194,00

Anti-limescale hand shower with flow closure. Fixed support for hand shower. Satin hose. G3/8 flexible hoses.

Miscelatore monocomando per lavabo con doccia per wc

Doccino anticalcare con chiusura di flusso. Supporto fisso per doccia. Flessibile satinato. Flessibili di alimentazione G3/8.



913459210

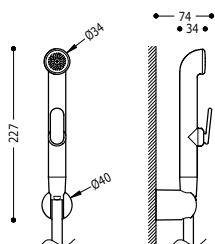

Shower kit for single-handle toilet tap

29995001

38,00

Hand shower with flow closure. Fixed support for hand shower. Satin hose. Attention: Spare part only for bidet ref: 181113.

Kit doccia per miscelatore monocomando per wc

Doccino con chiusura di flusso. Supporto fisso per doccia. Flessibile satinato. Attenzione: Ricambio solo per bidet rif: 181113.



WALL TAPS / RUBINETTI A MURO

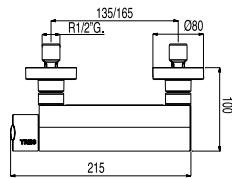

Wall-mounted single-handle shower mixer tap

181468

173,00

Anti-limescale: \varnothing 100 mm hand shower. (5 stream types).
Adjustable support for hand shower. Satin hose.

Miscelatore monocomando a muro per doccia

Doccino anticalcare: \varnothing 100 mm. (5 tipi di getto). Supporto orientabile per doccino. Flessibile satinato.

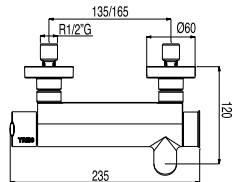

Wall-mounted single-handle mixer tap for bath and shower

181474

194,00

Anti-limescale: \varnothing 100 mm hand shower. (5 stream types).
Adjustable support for hand shower. Satin hose.

Miscelatore monocomando a muro per vasca e doccia

Doccino anticalcare: \varnothing 100 mm. (5 tipi di getto). Supporto orientabile per doccino. Flessibile satinato.

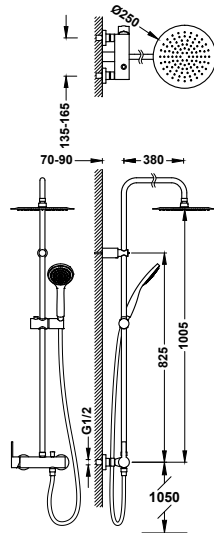

2-way wall-fitted single-handle shower mixer tap

18119102

412,00

- Stainless steel adjustable shower head: \varnothing 250 mm.
- Adjustable and sliding support for hand shower.
- Anti-limescale hand showers: \varnothing 100 mm.
- Satin hose.

Set miscelatore monocomando a muro 2 getti per doccia

- Soffione doccia orientabile in acciaio inossidabile: \varnothing 250 mm.
- Supporto scorrevole e orientabile per doccino.
- Doccino anticalcare: \varnothing 100 mm.
- Flessibile satinato.

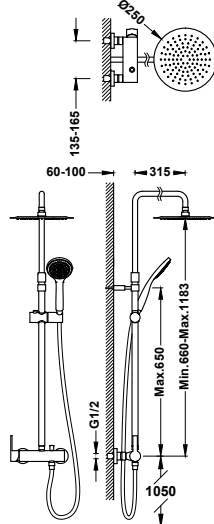

2-way wall-fitted single-handle shower mixer tap

08119703

470,00

- Stainless steel adjustable shower head: \varnothing 250 mm.
- Telescopic shower bar.
- Adjustable and sliding support for hand shower.
- Anti-limescale hand showers: \varnothing 100 mm.
- Satin hose.

Set miscelatore monocomando a muro 2 getti per doccia

- Soffione doccia orientabile in acciaio inossidabile: \varnothing 250 mm.
- Colonna doccia telescopica.
- Supporto scorrevole e orientabile per doccino.
- Doccino anticalcare: \varnothing 100 mm.
- Flessibile satinato.



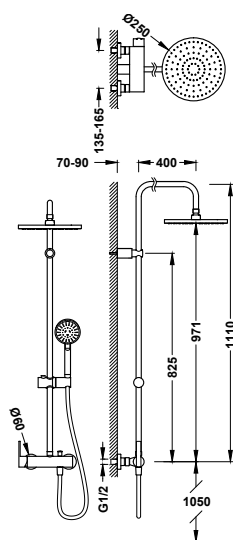

2-way wall-fitted single-handle shower mixer tap

181191

412,00

- Stainless steel adjustable shower head: \varnothing 250 mm.
- Adjustable and sliding support for hand shower.
- Anti-limescale hand showers: \varnothing 100 mm. (5 stream types).
- Satin hose.

Set miscelatore monocomando a muro 2 getti per doccia

- Soffione doccia orientabile in acciaio inossidabile: \varnothing 250 mm.
- Supporto scorrevole e orientabile per doccia.
- Doccino anticalcare: \varnothing 100 mm. (5 tipi di getto).
- Flessibile satinato.



9134592

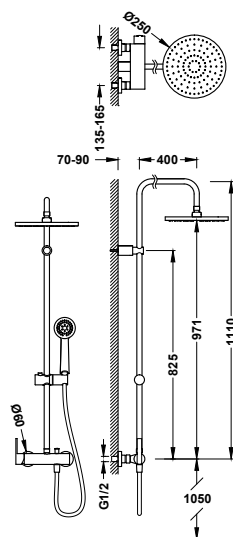

2-way wall-fitted single-handle shower mixer tap

081192

399,00

- Stainless steel adjustable shower head: \varnothing 250 mm.
- Adjustable and sliding support for hand shower.
- Anti-limescale hand showers: \varnothing 100 mm.
- Reinforced metal hose.

Set miscelatore monocomando a muro 2 getti per doccia

- Soffione doccia orientabile in acciaio inossidabile: \varnothing 250 mm.
- Supporto scorrevole e orientabile per doccia.
- Doccino anticalcare: \varnothing 100 mm.
- Flessibile rinforzato in metallo.



9134592

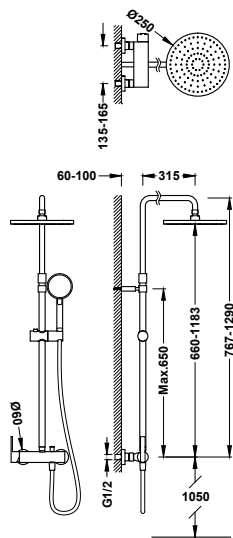

2-way wall-fitted single-handle shower mixer tap

08119702

475,00

- Stainless steel adjustable shower head: \varnothing 250 mm.
- Telescopic shower bar.
- Adjustable and sliding support for hand shower.
- Anti-limescale hand showers: \varnothing 100 mm. (5 stream types).
- Satin hose.

Set miscelatore monocomando a muro 2 getti per doccia

- Soffione doccia orientabile in acciaio inossidabile: \varnothing 250 mm.
- Colonna doccia telescopica.
- Supporto scorrevole e orientabile per doccia.
- Doccino anticalcare: \varnothing 100 mm. (5 tipi di getto).
- Flessibile satinato.



9134592

08119302

433,00

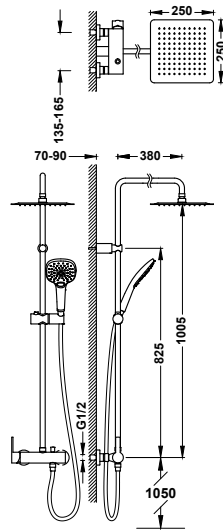

2-way wall-fitted single-handle shower mixer tap

- Stainless steel adjustable shower head: 250x250 mm.
- Adjustable and sliding support for hand shower.
- Anti-limescale hand showers: 120x120 mm. (3 stream types).
- Satin hose.

Set miscelatore monocomando a muro 2 getti per doccia

- Soffione doccia orientabile in acciaio inossidabile: 250x250 mm.
- Supporto scorrevole e orientabile per doccia.
- Doccino anticalcare: 120x120 mm. (3 tipi di getto).
- Flessibile satinato.



08119704

497,00

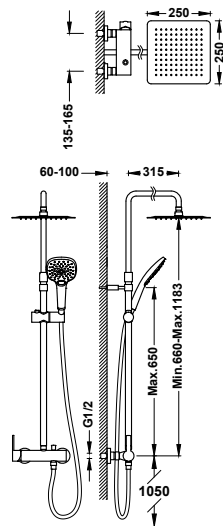

2-way wall-fitted single-handle shower mixer tap

- Stainless steel adjustable shower head: 250x250 mm.
- Telescopic shower bar.
- Adjustable and sliding support for hand shower.
- Anti-limescale hand showers: 120x120 mm. (3 stream types).
- Satin hose.

Set miscelatore monocomando a muro 2 getti per doccia

- Soffione doccia orientabile in acciaio inossidabile: 250x250 mm.
- Colonna doccia telescopica.
- Supporto scorrevole e orientabile per doccia.
- Doccino anticalcare: 120x120 mm. (3 tipi di getto).
- Flessibile satinato.



08119301

425,00

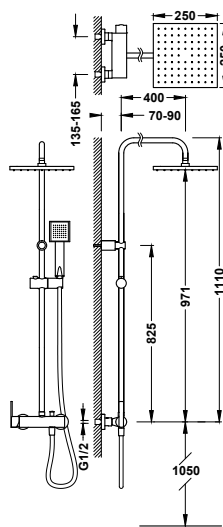

2-way wall-fitted single-handle shower mixer tap

- Stainless steel adjustable shower head: 250x250 mm.
- Adjustable and sliding support for hand shower.
- Anti-limescale hand showers: 80x80 mm.
- Satin hose.

Set miscelatore monocomando a muro 2 getti per doccia

- Soffione doccia orientabile in acciaio inossidabile: 250x250 mm.
- Supporto scorrevole e orientabile per doccia.
- Doccino anticalcare: 80x80 mm.
- Flessibile satinato.



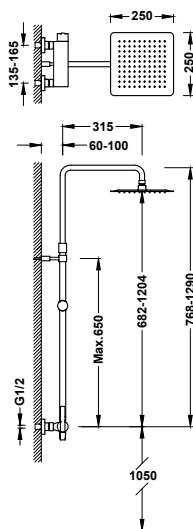

2-way wall-fitted single-handle shower mixer tap

08119701

451,00

- Stainless steel adjustable shower head: 250x250 mm.
- Telescopic shower bar.
- Adjustable and sliding support for hand shower.
- Anti-limescale hand showers.
- Satin hose.

Set miscelatore monocomando a muro 2 getti per doccia

- Soffione doccia orientabile in acciaio inossidabile: 250x250 mm.
- Colonna doccia telescopica.
- Supporto scorrevole e orientabile per doccia.
- Doccino anticalcare.
- Flessibile satinato.



CONCEALED TAPS/ RUBINETTI DA INCASSO

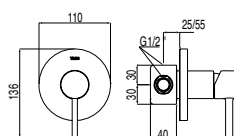

1-way concealed single-handle shower mixer tap

20317701

100,00

Concealed body included.

Miscelatore monocomando a incasso 1 getto per doccia

Corpo a incasso incluso.

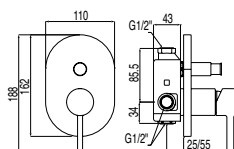

2-way concealed single-handle shower mixer tap

20318001

152,00

Concealed body included. 2-way diverter.

Miscelatore monocomando a incasso 2 getti per doccia

Corpo a incasso incluso. Inverter a 2 getti.

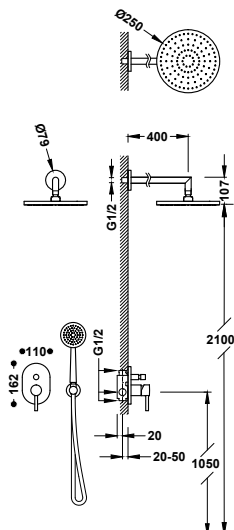

2-way concealed single-handle shower mixer tap kit

20318002

401,00

- Concealed body included.
- 2-way diverter.
- Wall-mounted arm with adjustable stainless steel shower head: Ø 250 mm.
- Wall-mounted support for hand shower with water supply.
- Anti-limescale hand showers: Ø 100 mm.
- Satin hose.

Kit di miscelatore monocomando a incasso 2 getti per doccia

- Corpo a incasso incluso.
- Inverter a 2 getti.
- Braccio a muro con soffione doccia orientabile in acciaio inossidabile: Ø 250 mm.
- Supporto per doccia con presa d'acqua a muro.
- Doccino anticalcare: Ø 100 mm.
- Flessibile satinato.



BATH TAPS / RUBINETTI PER VASCA

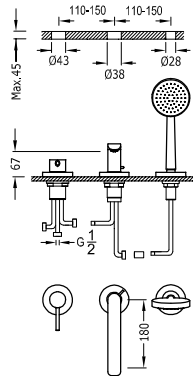

Single-handle bath edge mixer tap

20316102 330,00

- Inverter integrated into the bath spout.
- Anti-limescale hand showers: Ø 100 mm.
- 180 mm bath spout. Water flow: 3 bar - 16 l/min.
- Optional tank kit not included ref: 20324501.

Miscelatore monocomando bordo vasca

- Inverter incorporato nella canna della vasca.
- Doccino anticalcare: Ø 100 mm.
- Canna della vasca di 180 mm. Flusso: 3 bar - 16 l/m.
- Kit contenitore opzionale non incluso rif: 20324501.



Tank for bath edge tapware
Contenitore per kit di miscelazione bordo vasca

20324501 415,00



Click-clack drainage valve for bath with overflow and drainage point
Valvola di scarico Click-clack per vasca con troppopieno e presa drenaggio

134445 100,00

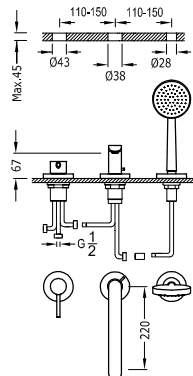

Single-handle bath edge mixer tap

20316101 340,00

- Inverter integrated into the bath spout.
- Anti-limescale hand showers: Ø 100 mm.
- 220 mm bath spout. Water flow: 3 bar - 16 l/min.
- Optional tank kit not included ref: 20324501.

Miscelatore monocomando bordo vasca

- Inverter incorporato nella canna della vasca.
- Doccino anticalcare: Ø 100 mm.
- Canna della vasca di 220 mm. Flusso: 3 bar - 16 l/m.
- Kit contenitore opzionale non incluso rif: 20324501.



Tank for bath edge tapware
Contenitore per kit di miscelazione bordo vasca

20324501 415,00



Click-clack drainage valve for bath with overflow and drainage point
Valvola di scarico Click-clack per vasca con troppopieno e presa drenaggio

134445 100,00

THERMOSTATIC WALL TAPS / RUBINETTO TERMOSTATICI A MURO

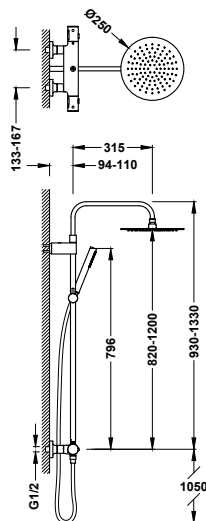

2-way Over-wall thermostatic shower mixer tap set

19038708 489,00

- With diverter integrated into the flow regulator.
- Telescopic shower bar.
- Round handle.
- Stainless steel adjustable shower head: 300x300 mm.
- Adjustable and sliding support for hand shower.
- Anti-limescale brass hand shower.
- Satin hose.

Set di miscelatore termostatico a muro Over-wall 2 getti per doccia

- Con inverter incorporato nel regolatore di flusso.
- Colonna doccia telescopica.
- Manopola rotonda.
- Soffione doccia orientabile in acciaio inossidabile: 300x300 mm.
- Supporto scorrevole e orientabile per doccia.
- Doccino anticalcare in ottone.
- Flessibile satinato.

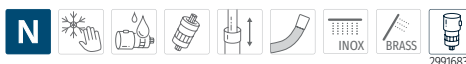

THERMOSTATIC CONCEALED TAPS / RUBINETTI TERMOSTATICI DA INCASSO

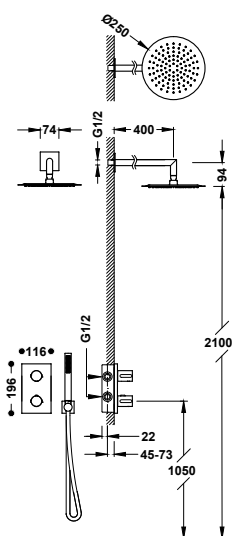

Therm-box 2-way concealed thermostatic tap kit for showers

06225004

515,00

- Concealed body included.
- Round handle with temperature control. 2-way ceramic distributor.
- Wall-mounted arm with adjustable stainless steel shower head: Ø 250 mm.
- Wall-mounted support for hand shower with water supply.
- Anti-limescale brass hand shower.
- Satin hose.

Kit di miscelatore termostatico da incasso a 2 getti Therm-box per doccia

- Corpo a incasso incluso.
- Manopola rotonda con controllo della temperatura. Erogatore in ceramica a 2 getti.
- Braccio a muro con soffione doccia orientabile in acciaio inossidabile: Ø 250 mm.
- Supporto per doccia con presa d'acqua a muro.
- Doccino anticalcare in ottone.
- Flessibile satinato.



SHUT-OFF VALVES / VALVOLE DI INTERCETTAZIONE

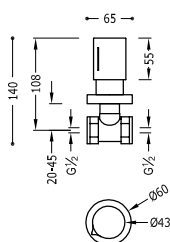

Concealed shut-off valve

06115501

83,00

Female thread connection: 1/2".

Valvola di intercettazione a incasso

Attacco a filetto femmina: 1/2".

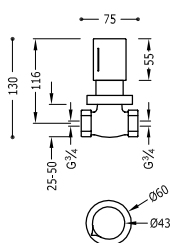

Concealed shut-off valve

06151101

91,00

Female thread connection: 3/4".

Valvola di intercettazione a incasso

Attacco a filetto femmina: 3/4".



CLASS

The Class series is the fruit of the clear goal to provide as much well-being and comfort as possible in your bathroom. Featuring modern lines, it suits any kind of space, whether small or large.

La serie Class nasce con il chiaro obiettivo di offrire tutto il benessere e il comfort possibili in bagno. È una serie di linee attuali che si inserisce perfettamente in tutti i tipi di spazi, piccoli e grandi.







WASHBASIN TAPS / RUBINETTI PER LAVABO

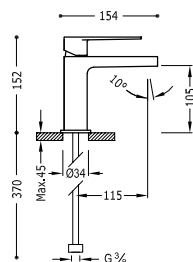

Single-handle washbasin mixer tap

G3/8 flexible hoses.

Miscelatore monocomando per lavabo

Flessibili di alimentazione G3/8.

20510301 107,00
 20510301D 130,00

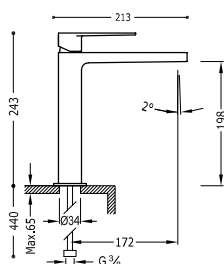

High single-handle washbasin mixer tap

G3/8 flexible hoses.

Miscelatore monocomando alto per lavabo

Flessibili di alimentazione G3/8.

20510303 210,00

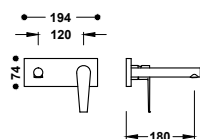

Visible part for recessed sink body

Visible part only. Includes concealing plate, handle and 180 mm spout. Recessed body not included.

Elemento a vista per il corpo a incasso da lavello

Solo parte a vista. Include piastra decorativa, comando e beccuccio da 180 mm. Corpo a incasso non incluso.

20530031 125,00



Recessed body for sink tap

Corpo a incasso per rubinetto da lavello

20830002 85,00

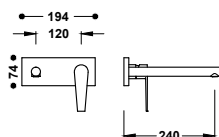

Visible part for recessed sink body

Visible part only. Includes concealing plate, handle and 240 mm spout. Recessed body not included.

Elemento a vista per il corpo a incasso da lavello

Solo parte a vista. Include piastra decorativa, comando e beccuccio da 240 mm. Corpo a incasso non incluso.

20530032 135,00



Recessed body for sink tap

Corpo a incasso per rubinetto da lavello

20830002 85,00

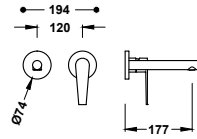

Visible part for recessed sink body

20530021

135,00

Visible part only. Includes concealing plate, handle and 177 mm spout. Recessed body not included.

Elemento a vista per il corpo a incasso da lavello

Solo parte a vista. Include piastra decorativa, comando e beccuccio da 177 mm. Corpo a incasso non incluso.



Recessed body for sink tap

20830002

85,00

Corpo a incasso per rubinetto da lavello

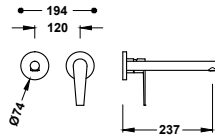

Visible part for recessed sink body

20530022

145,00

Visible part only. Includes concealing plate, handle and 237 mm spout. Recessed body not included.

Elemento a vista per il corpo a incasso da lavello

Solo parte a vista. Include piastra decorativa, comando e beccuccio da 237 mm. Corpo a incasso non incluso.



Recessed body for sink tap

20830002

85,00

Corpo a incasso per rubinetto da lavello

BIDET TAPS / RUBINETTI PER BIDET

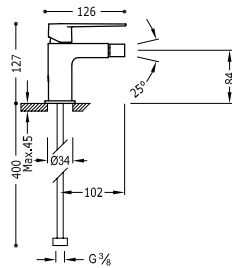

Single-handle bidet mixer tap

20512001

110,00

Adjustable shower head. G3/8 flexible hoses.

20512001D

133,00

Miscelatore monocomando per bidet

Supporto orientabile. Flessibili di alimentazione G3/8.



9130190

WALL TAPS / RUBINETTI A MURO

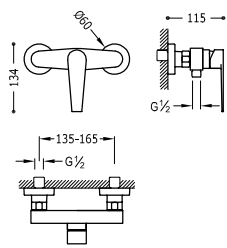

Wall-mounted single-handle shower mixer tap

20516701

137,00

Anti-limescale hand shower. Adjustable support for hand shower. Satin hose.

Miscelatore monocomando a muro per doccia

Doccino anticalcare. Supporto orientabile per doccino. Flessibile satinato.



910719005

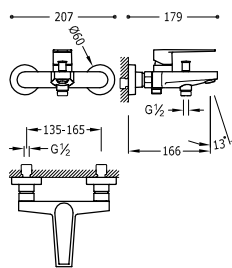

Wall-mounted single-handle mixer tap for bath and shower

20517001

158,00

Anti-limescale hand shower. Adjustable support for hand shower. Satin hose.

Miscelatore monocomando a muro per vasca e doccia

Doccino anticalcare. Supporto orientabile per doccino. Flessibile satinato.



9130190

CONCEALED TAPS / RUBINETTI DA INCASSO

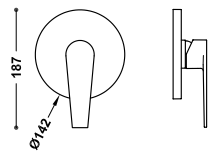

Visible part for concealed 1-way Rapid-box

20527810

79,00

Only visible part. Includes trim plate, control, bush and concealed attachment screw. Complete with concealed Rapid-box ref.: 20827810.

Pezzo vista per cassa da incasso a 1 via Rapid-box

Solo parte vista. Include piastra decorativa, comando, boccola e vite di fissaggio occulta. Completare con scatola da incasso Rapid-box rif.: 20827810.



Concealed 1-way Rapid-box with single-handle mixer tap for shower

20827810

80,00

Scatola da incasso a 1 via Rapid-box con miscelatore monocomando per doccia

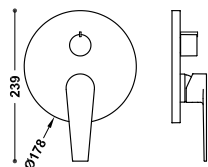

Visible part for concealed 2-way Rapid-box

20528110

100,00

Only visible part. Includes trim plate, control, distribution handle and concealed attachment screw. Complete with concealed Rapid-box ref.: 20828110.

Pezzo vista per cassa da incasso a 2 vie Rapid-box

Solo parte vista. Include piastra decorativa, comando, volante distributore e vite di fissaggio occulta. Completare con scatola da incasso Rapid-box rif.: 20828110.



Concealed 2-way Rapid-box with single-handle mixer tap for shower and bath

20828110

90,00

Scatola da incasso a 2 vie Rapid-box con miscelatore monocomando per doccia e vasca da bagno

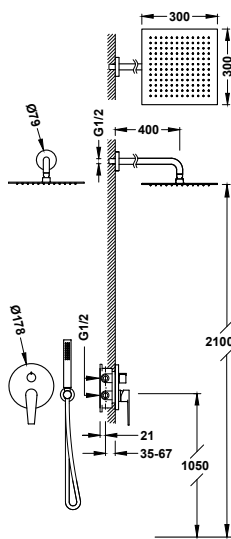

Rapid-box 2-way concealed single-handle shower mixer tap kit

20528004

452,00

- Concealed body included.
- 2-way ceramic distributor.
- Wall-mounted arm with adjustable stainless steel shower head: 300x300 mm.
- Wall-mounted support for hand shower with water supply.
- Anti-limescale hand shower.
- Satin hose.

Kit di miscelatore monocomando a incasso 2 getti Rapid-box per doccia

- Corpo a incasso incluso.
- Erogatore in ceramica a 2 getti.
- Braccio a muro con soffione doccia orientabile in acciaio inossidabile: 300x300 mm.
- Supporto per doccia con presa d'acqua a muro.
- Doccino anticalcare.
- Flessibile satinato.

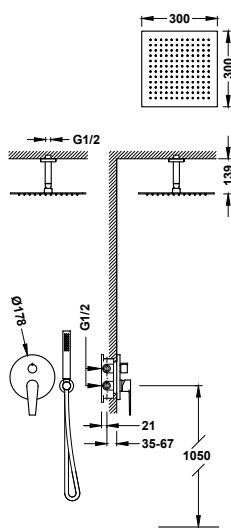

Rapid-box 2-way concealed single-handle shower mixer tap kit

20528003

428,00

- Concealed body included.
- 2-way ceramic distributor.
- Ceiling-mounted arm with adjustable stainless steel shower head: 300x300 mm.
- Wall-mounted support for hand shower with water supply.
- Anti-limescale hand shower.
- Satin hose.

Kit di miscelatore monocomando a incasso 2 getti Rapid-box per doccia

- Corpo a incasso incluso.
- Erogatore in ceramica a 2 getti.
- Braccio a soffitto con soffione doccia orientabile in acciaio inossidabile: 300x300 mm.
- Supporto per doccia con presa d'acqua a muro.
- Doccino anticalcare.
- Flessibile satinato.

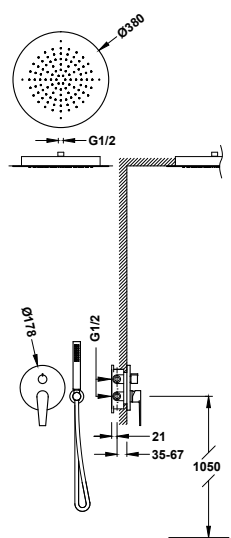

Rapid-box 2-way concealed single-handle shower mixer tap kit

20528005

905,00

- Concealed body included.
- 2-way ceramic distributor.
- Concealed stainless steel ceiling-mounted shower head: Ø 380 mm.
- Wall-mounted support for hand shower with water supply.
- Anti-limescale hand shower.
- Satin hose.

Kit di miscelatore monocomando a incasso 2 getti Rapid-box per doccia

- Corpo a incasso incluso.
- Erogatore in ceramica a 2 getti.
- Soffione doccia soffitto a incasso in acciaio inossidabile: Ø 380 mm.
- Supporto per doccia con presa d'acqua a muro.
- Doccino anticalcare.
- Flessibile satinato.



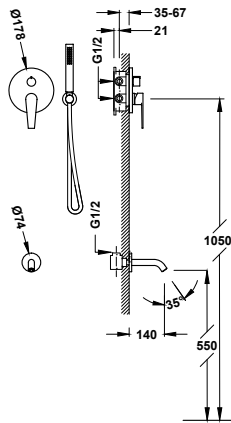

Rapid-box 2-way concealed single-handle mixer tap kit for bath and shower

20528006

335,00

- Concealed body included.
- 2-way ceramic distributor.
- Fixed wall-mounted spout.
- Wall-mounted support for hand shower with water supply.
- Anti-limescale hand shower.
- Satin hose.

Kit di miscelatore monocomando a incasso a 2 getti Rapid-box per vasca e doccia

- Corpo a incasso incluso.
- Erogatore in ceramica a 2 getti.
- Canna fissa a muro.
- Supporto per doccia con presa d'acqua a muro.
- Doccino anticalcare.
- Flessibile satinato.

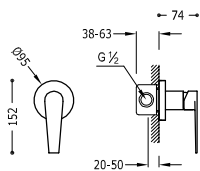

1-way concealed single-handle shower mixer tap

20517701

97,00

Concealed body included.

Miscelatore monocomando a incasso 1 getto per doccia

Corpo a incasso incluso.

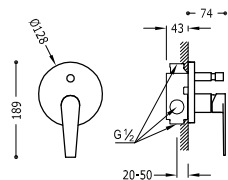

2-way concealed single-handle shower mixer tap

20518001

139,00

Concealed body included. 2-way diverter.

Miscelatore monocomando a incasso 2 getti per doccia

Corpo a incasso incluso. Inverter a 2 getti.

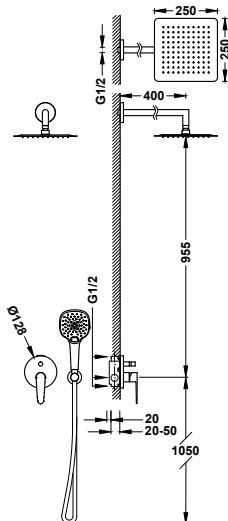

2-way concealed single-handle shower mixer tap kit

20518006

418,00

- Concealed body included.
- 2-way diverter.
- Wall-mounted arm with adjustable stainless steel shower head: 250x250 mm.
- Wall-mounted support for hand shower with water supply.
- Anti-limescale hand showers: 120x120 mm. (3 stream types).
- Satin hose.

Kit di miscelatore monocomando a incasso 2 getti per doccia

- Corpo a incasso incluso.
- Inverter a 2 getti.
- Braccio a muro con soffione doccia orientabile in acciaio inossidabile: 250x250 mm.
- Supporto per doccia con presa d'acqua a muro.
- Doccino anticalcare: 120x120 mm. (3 tipi di getto).
- Flessibile satinato.



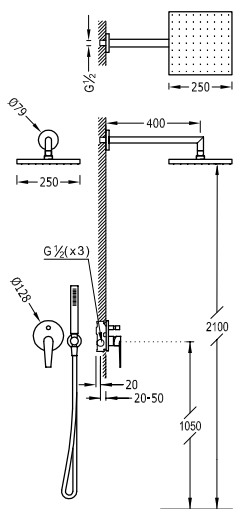

2-way concealed single-handle shower mixer tap kit

20518002

412,00

- Concealed body included.
- 2-way diverter.
- Wall-mounted arm with adjustable stainless steel shower head: 250x250 mm.
- Wall-mounted support for hand shower with water supply.
- Anti-limescale hand shower.
- Satin hose.

Kit di miscelatore monocomando a incasso 2 getti per doccia

- *Corpo a incasso incluso.*
- *Inverter a 2 getti.*
- *Braccio a muro con soffione doccia orientabile in acciaio inossidabile: 250x250 mm.*
- *Supporto per doccino con presa d'acqua a muro.*
- *Doccino anticalcare.*
- *Flessibile satinato.*

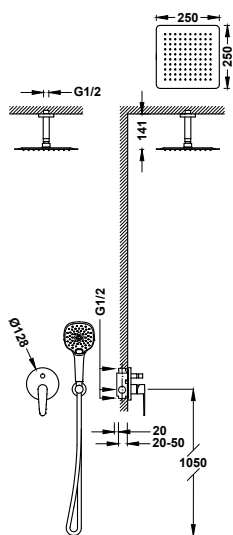

2-way concealed single-handle shower mixer tap kit

20518007

391,00

- Concealed body included.
- 2-way diverter.
- Ceiling-mounted arm with adjustable stainless steel shower head: 250x250 mm.
- Wall-mounted support for hand shower with water supply.
- Anti-limescale hand showers: 120x120 mm. (3 stream types).
- Satin hose.

Kit di miscelatore monocomando a incasso 2 getti per doccia

- *Corpo a incasso incluso.*
- *Inverter a 2 getti.*
- *Braccio a soffitto con soffione doccia orientabile in acciaio inossidabile: 250x250 mm.*
- *Supporto per doccino con presa d'acqua a muro.*
- *Doccino anticalcare: 120x120 mm. (3 tipi di getto).*
- *Flessibile satinato.*



BATH TAPS / RUBINETTI PER VASCA

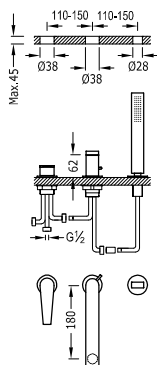

Single-handle bath edge mixer tap

20516103

310,00

- Inverter integrated into the bath spout.
- Anti-limescale hand shower.
- 180 mm bath spout. Water flow: 3 bar - 13 l/min.
- Optional tank kit not included ref: 20024501.

Miscelatore monocomando bordo vasca

- *Inverter incorporato nella canna della vasca.*
- *Doccino anticalcare.*
- *Canna della vasca di 180 mm. Flusso: 3 bar - 13 l/m.*
- *Kit contenitore opzionale non incluso rif: 20024501.*



Tank for bath edge tapware
Contenitore per kit di miscelazione bordo vasca

20324501

415,00



Click-clack drainage valve for bath with overflow and drainage point
Valvola di scarico Click-clack per vasca con troppopieno e presa drenaggio

134445

100,00



Single-handle bath edge mixer tap

20516101 320,00

- Inverter integrated into the bath spout.
- Anti-limescale hand shower.
- 230 mm bath spout. Water flow: 3 bar - 13 l/min.
- Optional tank kit not included ref.: 20024501.

Miscelatore monocomando bordo vasca

- Inverter incorporato nella canna della vasca.
- Doccino anticalcare.
- Canna della vasca di 230 mm. Flusso: 3 bar - 13 l/m.
- Kit contenitore opzionale non incluso rif.: 20024501.



Tank for bath edge tapware
Contenitore per kit di miscelazione bordo vasca

20324501 415,00



Click-clack drainage valve for bath with overflow and drainage point
Valvola di scarico Click-clack per vasca con troppopieno e presa drenaggio

134445 100,00

THERMOSTATIC WALL TAPS / RUBINETTO TERMOSTATICI A MURO

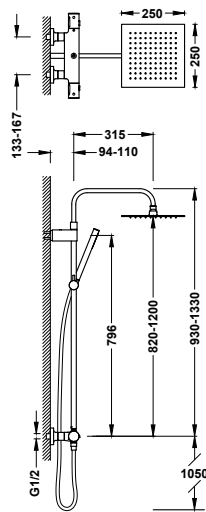

2-way Over-wall thermostatic shower mixer tap set

19038709 539,00

- With diverter integrated into the flow regulator.
- Telescopic shower bar.
- Round handle.
- Stainless steel adjustable shower head: 250x250 mm.
- Adjustable and sliding support for hand shower.
- Anti-limescale brass hand shower.
- Satin hose.

Set di miscelatore termostatico a muro Over-wall 2 getti per doccia

- Con inverter incorporato nel regolatore di flusso.
- Colonna doccia telescopica.
- Manopola rotonda.
- Soffione doccia orientabile in acciaio inossidabile: 250x250 mm.
- Supporto scorrevole e orientabile per doccino.
- Doccino anticalcare in ottone.
- Flessibile satinato.

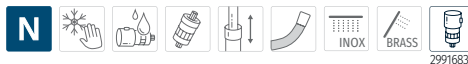

THERMOSTATIC CONCEALED TAPS / RUBINETTI TERMOSTATICI DA INCASSO

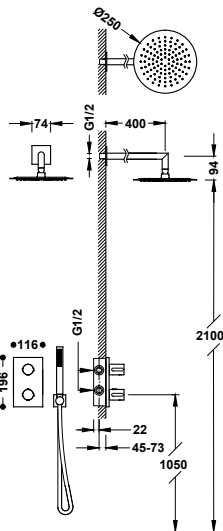

Therm-box 2-way concealed thermostatic tap kit for showers

06225004 515,00

- Concealed body included.
- Round handle with temperature control. 2-way ceramic distributor.
- Wall-mounted arm with adjustable stainless steel shower head: Ø 250 mm.
- Wall-mounted support for hand shower with water supply.
- Anti-limescale brass hand shower.
- Satin hose.

Kit di miscelatore termostatico da incasso a 2 getti Therm-box per doccia

- Corpo a incasso incluso.
- Manopola rotonda con controllo della temperatura. Erogatore in ceramica a 2 getti.
- Braccio a muro con soffione doccia orientabile in acciaio inossidabile: Ø 250 mm.
- Supporto per doccino con presa d'acqua a muro.
- Doccino anticalcare in ottone.
- Flessibile satinato.





FLAT

The wonder of Flat lies in its simplicity. Slender, comfortable and functional, this series results in an accessible yet special bathroom. Flat is simplicity personified.

La forza di Flat sta nella sua semplicità. Sottile, confortevole e funzionale, questa serie si traduce in un bagno accessibile ma speciale. Flat è la semplicità che fa la differenza.







WASHBASIN TAPS / RUBINETTI PER LAVABO

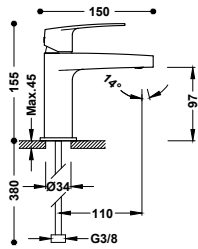

Single-handle washbasin mixer tap

22010301

85,00

G3/8 flexible hoses.

Miscelatore monocomando per lavabo

Flessibili di alimentazione G3/8.

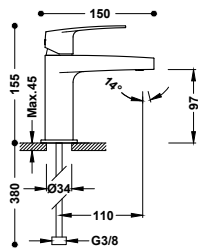

Eco-efficient single-handle washbasin mixer tap

22010401

93,00

G3/8 flexible hoses.

Miscelatore monocomando ecoefficiente per lavabo

Flessibili di alimentazione G3/8.

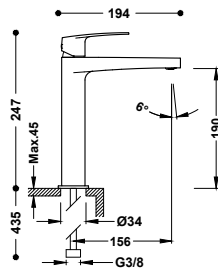

Eco-efficient high single-handle washbasin mixer tap

22020401

155,00

G3/8 flexible hoses.

Miscelatore monocomando alto ecoefficiente per lavabo

Flessibili di alimentazione G3/8.

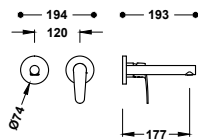

Visible part for recessed sink body

22030021

200,00

Visible part only. Includes concealing plate, handle and 177 mm spout. Recessed body not included.

Elemento a vista per il corpo a incasso da lavello

Solo parte a vista. Include piastra decorativa, comando e beccuccio da 177 mm. Corpo a incasso non incluso.



Recessed body for sink tap

20830002

Corpo a incasso per rubinetto da lavello

[→405](#)

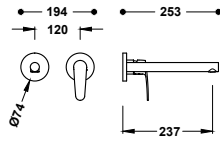

Visible part for recessed sink body

22030022

210,00

Visible part only. Includes concealing plate, handle and 237 mm spout. Recessed body not included.

Elemento a vista per il corpo a incasso da lavello

Solo parte a vista. Include piastra decorativa, comando e beccuccio da 237 mm. Corpo a incasso non incluso.



Recessed body for sink tap

20830002

Corpo a incasso per rubinetto da lavello

→405

BIDET TAPS / RUBINETTI PER BIDET

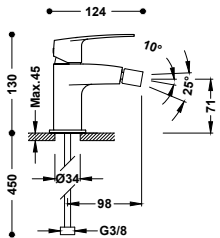

Single-handle bidet mixer tap

22012001

88,00

G3/8 flexible hoses.

Miscelatore monocomando per bidet

Flessibili di alimentazione G3/8.



WALL TAPS / RUBINETTI A MURO

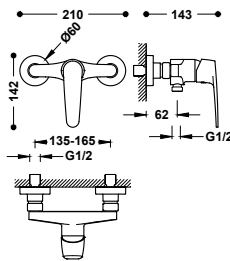

Wall-mounted single-handle shower mixer tap

22016701

120,00

Anti-limescale hand shower. Adjustable support for hand shower. Metal hose.

Miscelatore monocomando a muro per doccia

Doccino anticalcare. Supporto orientabile per doccino. Flessibile in metallo.

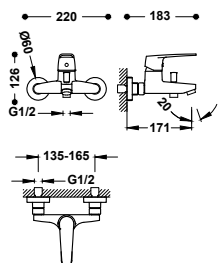

Wall-mounted single-handle mixer tap for bath and shower

22017001

140,00

Anti-limescale hand shower. Adjustable support for hand shower. Metal hose.

Miscelatore monocomando a muro per vasca e doccia

Doccino anticalcare. Supporto orientabile per doccino. Flessibile in metallo.



CONCEALED TAPS/ RUBINETTI DA INCASSO

Visible part for concealed 1-way Rapid-box

20427810

63,00

Only visible part. Includes trim plate, control, bush and concealed attachment screw. Complete with concealed Rapid-box ref: 20827810.

Pezzo vista per cassa da incasso a 1 via Rapid-box

Solo parte vista. Include piastra decorativa, comando, boccola e vite di fissaggio occulta. Completare con scatola da incasso Rapid-box rif: 20827810.

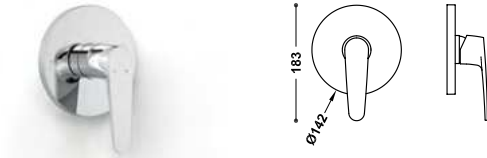

Concealed 1-way Rapid-box with single-handle mixer tap for shower

20827810

[→405](#)

Scatola da incasso a 1 via Rapid-box con miscelatore monocomando per doccia

Visible part for concealed 2-way Rapid-box

20428110

79,00

Only visible part. Includes trim plate, control, distribution handle and concealed attachment screw. Complete with concealed Rapid-box ref: 20828110.

Pezzo vista per cassa da incasso a 2 vie Rapid-box

Solo parte vista. Include piastra decorativa, comando, volante distributore e vite di fissaggio occulta. Completare con scatola da incasso Rapid-box rif: 20828110.

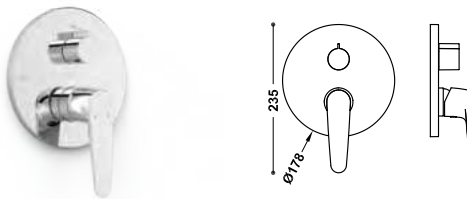

Concealed 2-way Rapid-box with single-handle mixer tap for shower and bath

20828110

[→405](#)

Scatola da incasso a 2 vie Rapid-box con miscelatore monocomando per doccia e vasca da bagno

Rapid-box 2-way concealed single-handle shower mixer tap kit

20428004

364,00

- Concealed body included.
- 2-way ceramic distributor.
- Wall-mounted arm with adjustable stainless steel shower head: Ø 250 mm.
- Wall-mounted support for hand shower with water supply.
- Anti-limescale hand showers: Ø 110 mm.
- Satin hose.

Kit di miscelatore monocomando a incasso 2 getti Rapid-box per doccia

- Corpo a incasso incluso.
- Erogatore in ceramica a 2 getti.
- Braccio a muro con soffione doccia orientabile in acciaio inossidabile: Ø 250 mm.
- Supporto per doccia con presa d'acqua a muro.
- Doccino anticalcare: Ø 110 mm.
- Flessibile satinato.

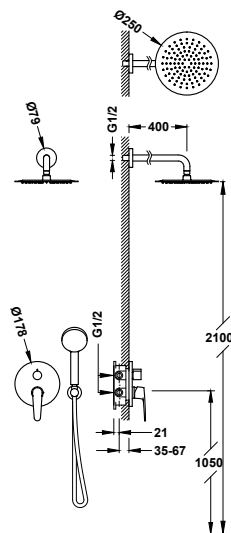

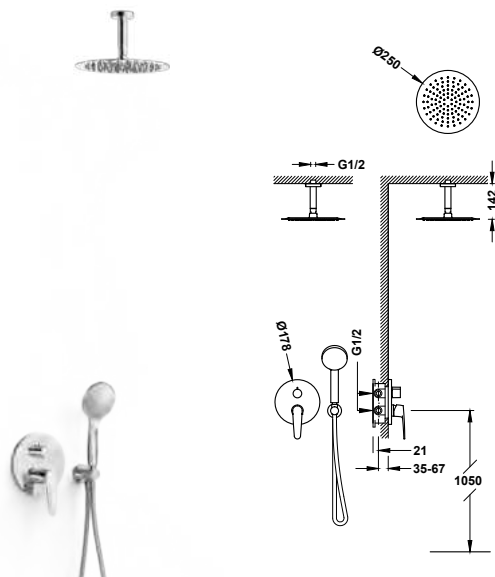

Rapid-box 2-way concealed single-handle shower mixer tap kit

20428003

337,00

- Concealed body included.
- 2-way ceramic distributor.
- Ceiling-mounted arm with adjustable stainless steel shower head: \varnothing 250 mm.
- Wall-mounted support for hand shower with water supply.
- Anti-limescale hand showers: \varnothing 110 mm.
- Satin hose.

Kit di miscelatore monocomando a incasso 2 getti Rapid-box per doccia

- Corpo a incasso incluso.
- Erogatore in ceramica a 2 getti.
- Braccio a soffitto con soffione doccia orientabile in acciaio inossidabile: \varnothing 250 mm.
- Supporto per doccia con presa d'acqua a muro.
- Doccino anticalcare: \varnothing 110 mm.
- Flessibile satinato.

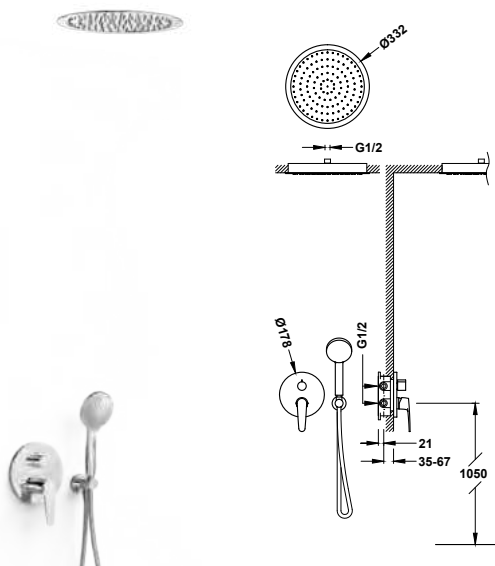

Rapid-box 2-way concealed single-handle shower mixer tap kit

20428005

603,00

- Concealed body included.
- 2-way ceramic distributor.
- Concealed brass ceiling-mounted shower head: \varnothing 332 mm.
- Wall-mounted support for hand shower with water supply.
- Anti-limescale hand showers: \varnothing 110 mm.
- Satin hose.

Kit di miscelatore monocomando a incasso 2 getti Rapid-box per doccia

- Corpo a incasso incluso.
- Erogatore in ceramica a 2 getti.
- Soffione da soffitto a incasso in ottone: \varnothing 332 mm.
- Supporto per doccia con presa d'acqua a muro.
- Doccino anticalcare: \varnothing 110 mm.
- Flessibile satinato.

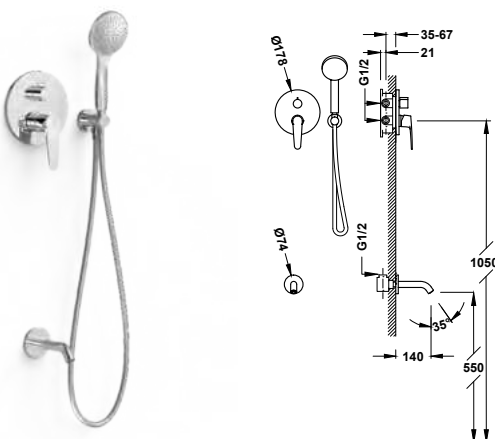

Rapid-box 2-way concealed single-handle mixer tap kit for bath and shower

20428006

310,00

- Concealed body included.
- 2-way ceramic distributor.
- Fixed wall-mounted spout.
- Wall-mounted support for hand shower with water supply.
- Anti-limescale: \varnothing 110 mm hand shower.
- Satin hose.

Kit di miscelatore monocomando a incasso a 2 getti Rapid-box per vasca e doccia

- Corpo a incasso incluso.
- Erogatore in ceramica a 2 getti.
- Canna fissa a muro.
- Supporto per doccia con presa d'acqua a muro.
- Doccino anticalcare: \varnothing 110 mm.
- Flessibile satinato.



1-way concealed single-handle shower mixer tap

20417701

95,00

Concealed body included.

Miscelatore monocomando a incasso 1 getto per doccia

Corpo a incasso incluso.

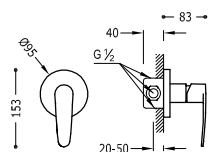

2-way concealed single-handle shower mixer tap

20418001

135,00

Concealed body included. 2-way diverter.

Miscelatore monocomando a incasso 2 getti per doccia

Corpo a incasso incluso. Inverter a 2 getti.

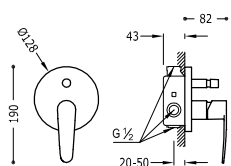

2-way concealed single-handle shower mixer tap kit

20418002

375,00

- Concealed body included.
- 2-way diverter.
- Wall-mounted arm with adjustable stainless steel shower head: Ø 250 mm.
- Wall-mounted support for hand shower with water supply.
- Anti-limescale hand showers: Ø 100 mm.
- Satin hose.

Kit di miscelatore monocomando a incasso 2 getti per doccia

- Corpo a incasso incluso.
- Inverter a 2 getti.
- Braccio a muro con soffione doccia orientabile in acciaio inossidabile: Ø 250 mm.
- Supporto per doccino con presa d'acqua a muro.
- Doccino anticalcare: Ø 100 mm.
- Flessibile satinato.

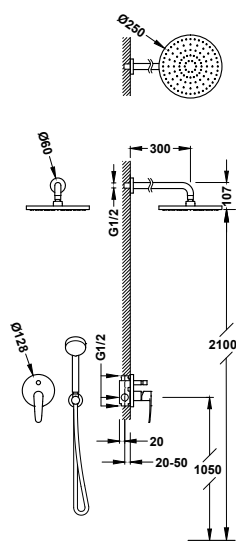

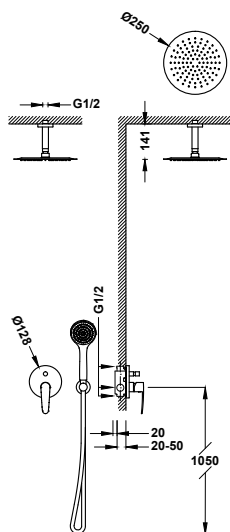

2-way concealed single-handle shower mixer tap kit

20418005 354,00

- Concealed body included.
- 2-way diverter.
- Ceiling-mounted arm with adjustable stainless steel shower head: Ø 250 mm.
- Wall-mounted support for hand shower with water supply.
- Anti-limescale hand showers: Ø 100 mm.
- Satin hose.

Kit di miscelatore monocomando a incasso 2 getti per doccia

- Corpo a incasso incluso.
- Inverter a 2 getti.
- Braccio a soffitto con soffione doccia orientabile in acciaio inossidabile: Ø 250 mm.
- Supporto per doccia con presa d'acqua a muro.
- Doccino anticalcare: Ø 100 mm.
- Flessibile satinato.



THERMOSTATIC WALL TAPS / RUBINETTO TERMOSTATICI A MURO

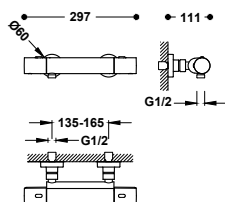

Over-wall thermostatic tap for the shower

19016419 163,00
19016419NM 346,00

- Anti-limescale: Ø 100 mm hand shower. Adjustable support for hand shower. Metal hose. ABS round handle.

Rubinetto termostatico a muro Over-wall per doccia

- Doccino anticalcare: Ø 100 mm. Supporto orientabile per doccia. Flessibile in metallo. Manopola rotonda in ABS.



Thermostatic tap without accessories

19016401 178,00
19016401NM 276,00

Rubinetto termostatico non accessoriato

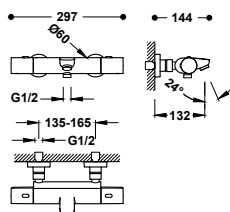

Over-wall thermostatic mixer tap for bath and shower

19017419 288,00
19017419NM 446,00

- Anti-limescale: Ø 100 mm hand shower. Adjustable support for hand shower. Metal hose. ABS round handle.

Vasca-Doccia termostatica Over-wall

- Doccino anticalcare: Ø 100 mm. Supporto orientabile per doccia. Flessibile in metallo. Manopola rotonda in ABS.



Thermostatic tap without accessories

19017401 243,00
19017401NM 377,00

Rubinetto termostatico non accessoriato

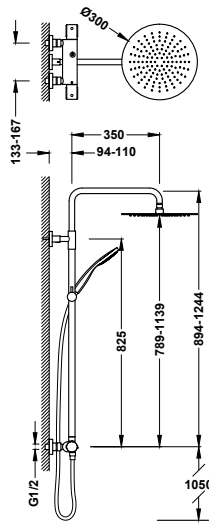

2-way Over-wall thermostatic shower mixer tap set

■ 19038701	480,00
■ 19038701NM	744,00

- With diverter integrated into the flow regulator.
- ABS round handle.
- Telescopic shower bar.
- Stainless steel adjustable shower head: Ø 300 mm.
- Adjustable and sliding support for hand shower.
- Anti-limescale hand shower.
- Metal hose.

Set di miscelatore termostatico a muro Over-wall 2 getti per doccia

- Con inverter incorporato nel regolatore di flusso.
- Manopola rotonda in ABS.
- Colonna doccia telescopica.
- Soffione doccia orientabile in acciaio inossidabile: Ø 300 mm.
- Supporto scorrevole e orientabile per doccino.
- Doccino anticalcare.
- Flessibile in metallo.

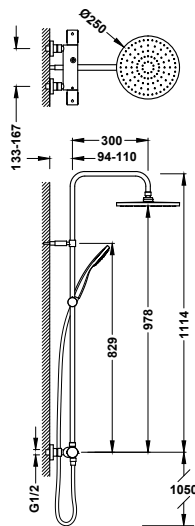

2-way Over-wall thermostatic shower mixer tap set

■ 19039301	412,00
■ 19039301NM	639,00

- With diverter integrated into the flow regulator.
- ABS round handle.
- Adjustable shower head: Ø 250 mm.
- Adjustable and sliding support for hand shower.
- Anti-limescale hand showers: Ø 100 mm.
- Metal hose.

Set di miscelatore termostatico a muro Over-wall 2 getti per doccia

- Con inverter incorporato nel regolatore di flusso.
- Manopola rotonda in ABS.
- Soffione doccia orientabile: Ø 250 mm.
- Supporto scorrevole e orientabile per doccino.
- Doccino anticalcare: Ø 100 mm.
- Flessibile in metallo.

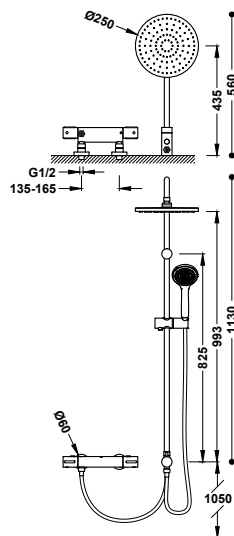

2-way Over-wall thermostatic shower mixer tap set

■ 19038501	475,00
------------	--------

- With diverter integrated into the flow regulator.
- ABS round handle.
- Adjustable shower head: Ø 250 mm.
- Adjustable and sliding support for hand shower.
- Anti-limescale hand showers: Ø 100 mm.
- Metal hose.

Set di miscelatore termostatico a muro Over-wall 2 getti per doccia

- Con inverter incorporato nel regolatore di flusso.
- Manopola rotonda in ABS.
- Soffione doccia orientabile: Ø 250 mm.
- Supporto scorrevole e orientabile per doccino.
- Doccino anticalcare: Ø 100 mm.
- Flessibile in metallo.



THERMOSTATIC CONCEALED TAPS / RUBINETTI TERMOSTATICI DA INCASSO

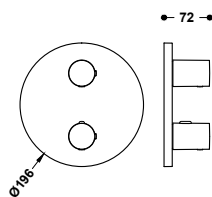

Visible part for concealed 2-way Therm-box

20425001

90,00

Only visible part. ABS round handle. Includes trim plate, control and distribution handle. Complete with concealed Therm-box ref.: 20785001.

Pezzo vista per cassa da incasso a 2 vie Therm-box

Solo parte vista. Manopola rotonda in ABS. Include piastra decorativa, comando e volante distributore. Completare con scatola da incasso Therm-box rif.: 20785001.



Therm-box 2-way concealed box with thermostatic tap for shower and bathtub

20785001

→405

Scatola da incasso a 2 getti Therm-box con miscelatore termostatico per doccia e vasca da bagno

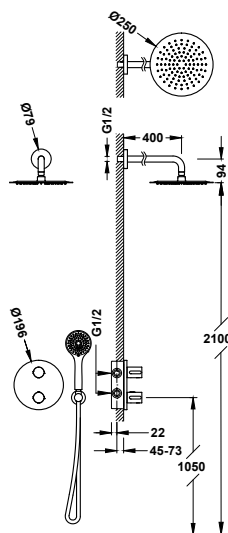

Therm-box 2-way concealed thermostatic tap kit for showers

20425004

526,00

- Concealed body included.
- ABS round handle with temperature control. 2-way ceramic distributor.
- Wall-mounted arm with adjustable stainless steel shower head: Ø 250 mm.
- Wall-mounted support for hand shower with water supply.
- Anti-limescale hand showers: Ø 100 mm. (3 stream types).
- Satin hose.

Kit di miscelatore termostatico da incasso a 2 getti Therm-box per doccia

- Corpo a incasso incluso.
- Manopola rotonda in ABS con controllo della temperatura.
- Erogatore in ceramica a 2 getti.
- Braccio a muro con soffione doccia orientabile in acciaio inossidabile: Ø 250 mm.
- Supporto per doccia con presa d'acqua a muro.
- Doccino anticalcare: Ø 100 mm. (3 tipi di getto).
- Flessibile satinato.

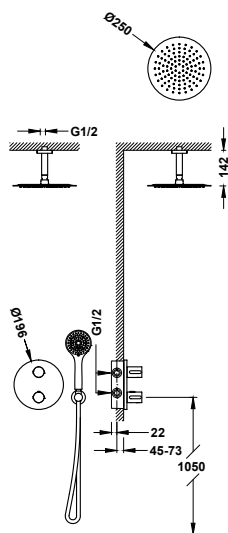

Therm-box 2-way concealed thermostatic tap kit for showers

20425003

496,00

- Concealed body included.
- ABS round handle with temperature control. 2-way ceramic distributor.
- Ceiling-mounted arm with adjustable stainless steel shower head: Ø 250 mm.
- Wall-mounted support for hand shower with water supply.
- Anti-limescale hand showers: Ø 100 mm. (3 stream types).
- Satin hose.

Kit di miscelatore termostatico da incasso a 2 getti Therm-box per doccia

- Corpo a incasso incluso.
- Manopola rotonda in ABS con controllo della temperatura.
- Erogatore in ceramica a 2 getti.
- Braccio a soffitto con soffione doccia orientabile in acciaio inossidabile: Ø 250 mm.
- Supporto per doccia con presa d'acqua a muro.
- Doccino anticalcare: Ø 100 mm. (3 tipi di getto).
- Flessibile satinato.



20425005

805,00

Therm-box 2-way concealed thermostatic tap kit for showers

- Concealed body included.
- ABS round handle with temperature control. 2-way ceramic distributor.
- Concealed brass ceiling-mounted shower head: Ø 332 mm.
- Wall-mounted support for hand shower with water supply.
- Anti-limescale hand showers: Ø 100 mm. (3 stream types).
- Satin hose.

**Kit di miscelatore termostatico da incasso a 2 getti
Therm-box per doccia**

- Corpo a incasso incluso.
- Manopola rotonda in ABS con controllo della temperatura. Ergatore in ceramica a 2 getti.
- Soffione da soffitto a incasso in ottone: Ø 332 mm.
- Supporto per doccia con presa d'acqua a muro.
- Doccino anticalcare: Ø 100 mm. (3 tipi di getto).
- Flessibile satinato.

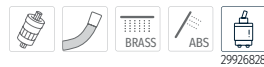
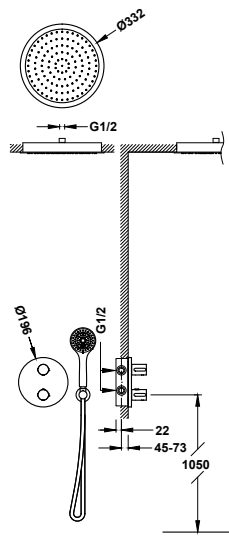

20425006

510,00

Therm-box 2-way concealed thermostatic tap kit for baths and showers

- Concealed body included.
- ABS round handle with temperature control. 2-way ceramic distributor.
- Fixed wall-mounted spout.
- Wall-mounted support for hand shower with water supply.
- Anti-limescale hand showers: Ø 100 mm. (3 stream types).
- Satin hose.

**Kit di miscelatore termostatico da incasso a 2 getti
Therm-box per vasca da bagno e doccia**

- Corpo a incasso incluso.
- Manopola rotonda in ABS con controllo della temperatura. Ergatore in ceramica a 2 getti.
- Canna fissa a muro.
- Supporto per doccia con presa d'acqua a muro.
- Doccino anticalcare: Ø 100 mm. (3 tipi di getto).
- Flessibile satinato.

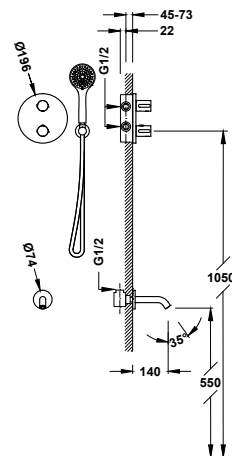



CANIGÓ PLUS

The balance between design and the perfect bathroom experience shouldn't be at odds with sustainability. Canigó Plus incorporates features that promote water and energy savings, helping turn any bathroom into a sustainable space.

L'equilibrio perfetto tra design, benessere nella stanza da bagno e sostenibilità. Canigó Plus aggiunge alla rubinetteria alcune caratteristiche che favoriscono il risparmio di acqua ed energia trasformando il bagno in uno spazio sostenibile.







WASHBASIN TAPS / RUBINETTI PER LAVABO

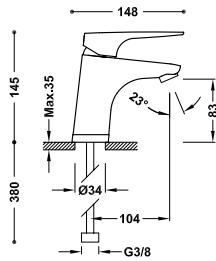

Single-handle washbasin mixer tap

21810303

82,00

G3/8 flexible hoses.

Miscelatore monocomando per lavabo

Flessibili di alimentazione G3/8.

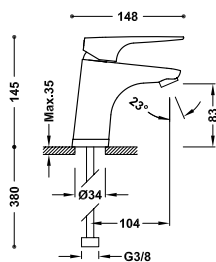

Single-handle washbasin mixer tap with Tres-duo

21810301

84,00

G3/8 flexible hoses.

Miscelatore monocomando per lavabo con Tres-duo

Flessibili di alimentazione G3/8.

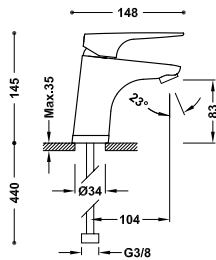

Eco-efficient single-handle washbasin mixer tap

21810401

91,00

G3/8 flexible hoses.

Miscelatore monocomando ecoefficiente per lavabo

Flessibili di alimentazione G3/8.

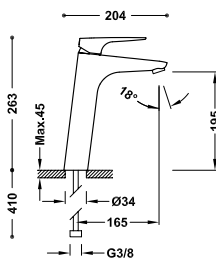

High single-handle washbasin mixer tap

21820303

145,00

G3/8 flexible hoses.

Miscelatore monocomando alto per lavabo

Flessibili di alimentazione G3/8.

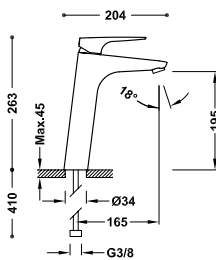

High single-handle washbasin mixer tap with Tres-duo

21820301

147,00

G3/8 flexible hoses.

Miscelatore monocomando alto per lavabo con Tres-duo

Flessibili di alimentazione G3/8.



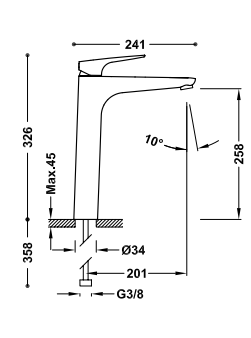



XXL single-handle washbasin mixer tap 21880301 180,00
 G3/8 flexible hoses.
Miscelatore monocomando XXL per lavabo
 Flessibili di alimentazione G3/8.

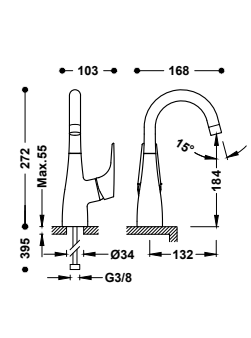

29903501

Single-handle washbasin mixer tap with lateral lever 21830802 128,00
 G3/8 flexible hoses.
Miscelatore monocomando con leva laterale per lavabo
 Flessibili di alimentazione G3/8.

29903508





High single-handle washbasin mixer tap with lateral lever 21830801 134,00
 G3/8 flexible hoses.
Miscelatore monocomando alto con leva laterale per lavabo
 Flessibili di alimentazione G3/8.





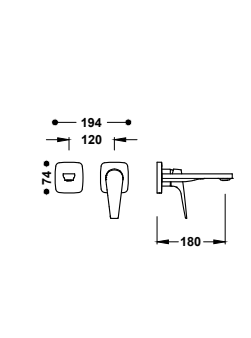

29903508 IA

Visible part for recessed sink body 21830023 108,00
 Visible part only. Includes concealing plate, handle and 180 mm spout. Recessed body not included.
Elemento a vista per il corpo a incasso da lavello
 Solo parte a vista. Include piastra decorativa, comando e beccuccio da 180 mm. Corpo a incasso non incluso.



Recessed body for sink tap 20830002
 Corpo a incasso per rubinetto da lavello →405

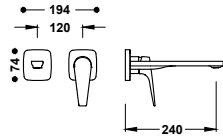

Visible part for recessed sink body

21830024

118,00

Visible part only. Includes concealing plate, handle and 240 mm spout. Recessed body not included.

Elemento a vista per il corpo a incasso da lavello

Solo parte a vista. Include piastra decorativa, comando e beccuccio da 240 mm. Corpo a incasso non incluso.



Recessed body for sink tap

20830002

Corpo a incasso per rubinetto da lavello

[↗ 405](#)

BIDET TAPS / RUBINETTI PER BIDET

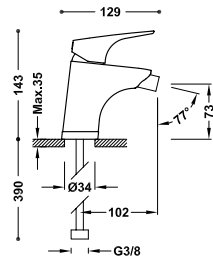

Single-handle bidet mixer tap

21812001

85,00

G3/8 flexible hoses.

Miscelatore monocomando per bidet

Flessibili di alimentazione G3/8.

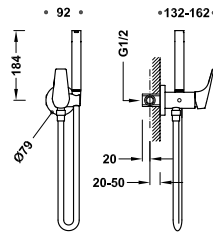

Concealed single lever WC/ bidet mixer

21712301

175,00

With cold and hot water. Hand shower with 5 l/min limiter coupling and non-drip system. Fixed support for hand shower for installation on right or left. Satin hose.

Miscelatore monocomando con doccia per wc

Con acqua fredda e calda. Doccino con limitatore a 5 l/min. e sistema antigocciolamento. Supporto fisso per doccia installabile a destra o a sinistra. Flessibile satinato.



WALL TAPS / RUBINETTI A MURO

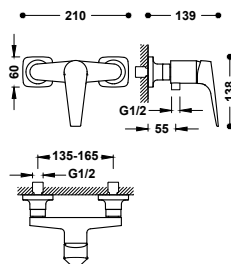

Wall-mounted single-handle shower mixer tap

21826701

98,00

Without accessories.

Miscelatore monocomando a muro per doccia

Senza complementi.



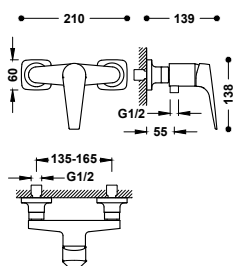

Wall-mounted single-handle shower mixer tap

21816701

118,00

120x120 mm anti-limescale hand shower. (3 stream types). Adjustable support for hand shower. Reinforced metal hose.

Miscelatore monocomando a muro per doccia

Doccino anticalcare 120x120 mm. (3 tipi di getto). Supporto orientabile per doccino. Flessibile rinforzato in metallo.

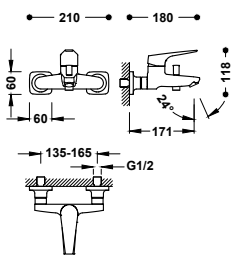

Wall-mounted single-handle mixer tap for bath and shower

21827001

118,00

Without accessories.

Miscelatore monocomando a muro per vasca e doccia

Senza complementi.

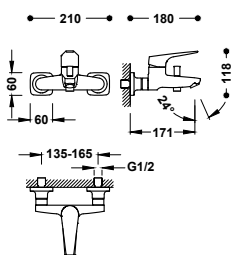

Wall-mounted single-handle mixer tap for bath and shower

21817001

139,00

120x120 mm anti-limescale hand shower. (3 stream types). Adjustable support for hand shower. Reinforced metal hose.

Miscelatore monocomando a muro per vasca e doccia

Doccino anticalcare 120x120 mm. (3 tipi di getto). Supporto orientabile per doccino. Flessibile rinforzato in metallo.

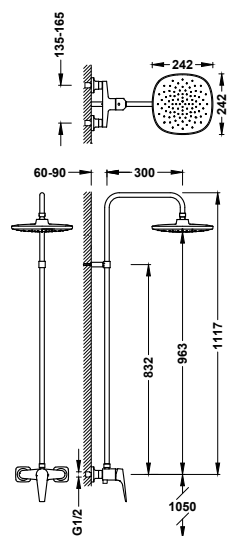
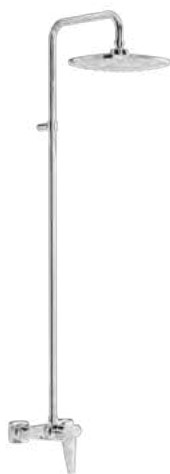

1-way wall-fitted single-handle shower mixer tap set

21899501

255,00

· Adjustable shower head: 242x242 mm.

Set miscelatore monocomando a muro 1 getto per doccia

· Soffione doccia orientabile: 242x242 mm.



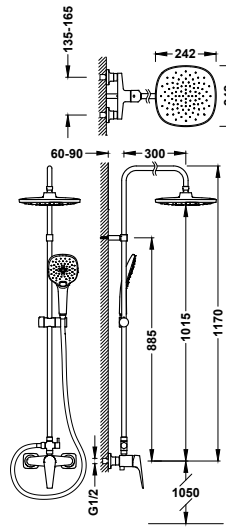

2-way wall-fitted single-handle shower mixer tap

21819101 300,00

- With inverter integrated into the shower bar.
- Adjustable shower head: 242x242 mm.
- Adjustable and sliding support for hand shower.
- 120x120 mm anti-limescale hand shower. (3 stream types).
- Metal hose.

Set miscelatore monocomando a muro 2 getti per doccia

- Con inverter incorporato nella colonna doccia.
- Soffione doccia orientabile: 242x242 mm.
- Supporto scorrevole e orientabile per doccino.
- Doccino anticalcare 120x120 mm. (3 tipi di getto).
- Flessibile in metallo.

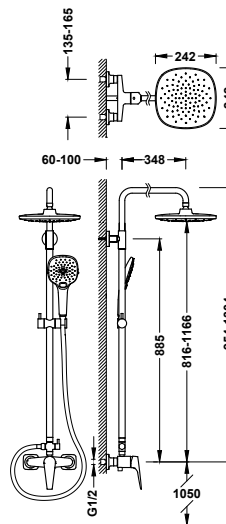

2-way wall-fitted single-handle shower mixer tap

21831221 417,00

- With inverter integrated into the shower bar.
- Telescopic shower bar.
- Adjustable shower head: 242x242 mm.
- Adjustable and sliding support for hand shower.
- 120x120 mm anti-limescale hand shower. (3 stream types).
- Metal hose.

Set miscelatore monocomando a muro 2 getti per doccia

- Con inverter incorporato nella colonna doccia.
- Colonna doccia telescopica.
- Soffione doccia orientabile: 242x242 mm.
- Supporto scorrevole e orientabile per doccino.
- Doccino anticalcare 120x120 mm. (3 tipi di getto).
- Flessibile in metallo.

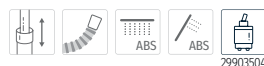

CONCEALED TAPS/ RUBINETTI DA INCASSO

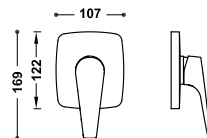

Visible part for concealed 1-way Rapid-box

21827810 63,00

Only visible part. Includes trim plate, control, bush and concealed attachment screw. Complete with concealed Rapid-box ref.: 20827810.

Pezzo vista per cassa da incasso a 1 via Rapid-box

Solo parte vista. Include piastra decorativa, comando, boccola e vite di fissaggio occulta. Completare con scatola da incasso Rapid-box rif.: 20827810.



Concealed 1-way Rapid-box with single-handle mixer tap for shower

20827810

→ 405

Scatola da incasso a 1 via Rapid-box con miscelatore monocomando per doccia

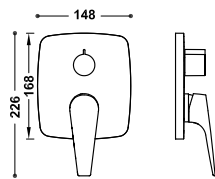

Visible part for concealed 2-way Rapid-box

21828110

79,00

Only visible part. Includes trim plate, control, distribution handle and concealed attachment screw. Complete with concealed Rapid-box ref.: 20828110.

Pezzo vista per cassa da incasso a 2 vie Rapid-box

Solo parte vista. Include piastra decorativa, comando, volante distributore e vite di fissaggio occulta. Completare con scatola da incasso Rapid-box rif.: 20828110.



Concealed 2-way Rapid-box with single-handle mixer tap for shower and bath

20828110

[→405](#)

Scatola da incasso a 2 vie Rapid-box con miscelatore monocomando per doccia e vasca da bagno

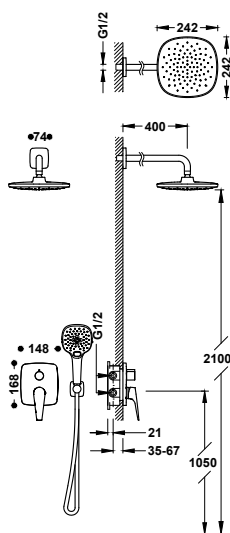

Rapid-box 2-way concealed single-handle shower mixer tap kit

21828004

370,00

- Concealed body included.
- 2-way ceramic distributor.
- Wall-mounted arm with adjustable shower head: 242x242 mm.
- Wall-mounted support for hand shower with water supply.
- 120x120 mm anti-limescale hand shower. (3 stream types).
- Metal hose.

Kit di miscelatore monocomando a incasso 2 getti Rapid-box per doccia

- Corpo a incasso incluso.
- Erogatore in ceramica a 2 getti.
- Braccio a muro con soffione doccia orientabile: 242x242 mm.
- Supporto per doccia con presa d'acqua a muro.
- Doccino anticalcare 120x120 mm. (3 tipi di getto).
- Flessibile in metallo.

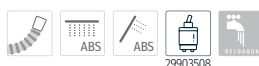

29903508

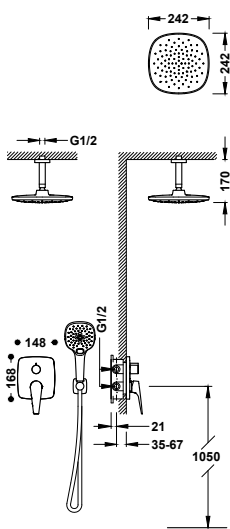

Rapid-box 2-way concealed single-handle shower mixer tap kit

21828003

343,00

- Concealed body included.
- 2-way ceramic distributor.
- Ceiling-mounted arm with adjustable shower head: 242x242 mm.
- Wall-mounted support for hand shower with water supply.
- 120x120 mm anti-limescale hand shower. (3 stream types).
- Metal hose.

Kit di miscelatore monocomando a incasso 2 getti Rapid-box per doccia

- Corpo a incasso incluso.
- Erogatore in ceramica a 2 getti.
- Braccio a soffitto con soffione doccia orientabile: 242x242 mm.
- Supporto per doccia con presa d'acqua a muro.
- Doccino anticalcare 120x120 mm. (3 tipi di getto).
- Flessibile in metallo.



29903508

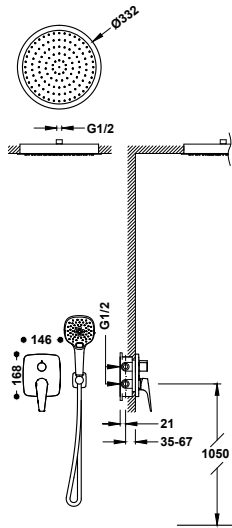

Rapid-box 2-way concealed single-handle shower mixer tap kit

21828005

592,00

- Concealed body included.
- 2-way ceramic distributor.
- Concealed brass ceiling-mounted shower head: Ø 332 mm.
- Wall-mounted support for hand shower with water supply.
- 120x120 mm anti-limescale hand shower. (3 stream types).
- Metal hose.

Kit di miscelatore monocomando a incasso 2 getti Rapid-box per doccia

- Corpo a incasso incluso.
- Erogatore in ceramica a 2 getti.
- Soffione da soffitto a incasso in ottone: Ø 332 mm.
- Supporto per doccino con presa d'acqua a muro.
- Doccino anticalcare 120x120 mm. (3 tipi di getto).
- Flessibile in metallo.



Rapid-box 2-way concealed single-handle mixer tap kit for bath and shower

21828006

340,00

- Concealed body included.
- 2-way ceramic distributor.
- Fixed wall-mounted spout.
- Wall-mounted support for hand shower with water supply.
- 120x120 mm anti-limescale hand shower. (3 stream types).
- Metal hose.

Kit di miscelatore monocomando a incasso a 2 getti Rapid-box per vasca e doccia

- Corpo a incasso incluso.
- Erogatore in ceramica a 2 getti.
- Canna fissa a muro.
- Supporto per doccino con presa d'acqua a muro.
- Doccino anticalcare 120x120 mm. (3 tipi di getto).
- Flessibile in metallo.

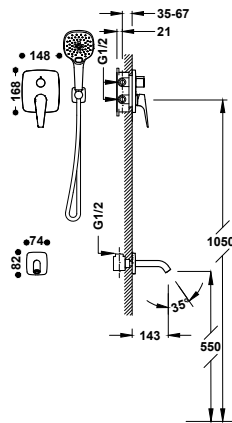

THERMOSTATIC WALL TAPS / RUBINETTO TERMOSTATICI A MURO

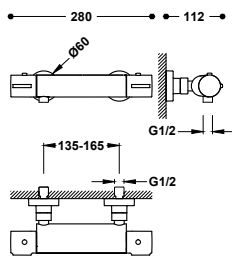

Wall-mounted thermostatic shower mixer tap

21716409

227,00

- 120x120 mm anti-limescale hand shower. (3 stream types).
- Adjustable support for hand shower. Metal hose. Round handle.

Miscelatore termostatico a muro per doccia

- Doccetta anticalcare 120x120 mm. (3 tipi di getto). Supporto orientabile per doccino. Flessibile in metallo. Manopola rotonda.

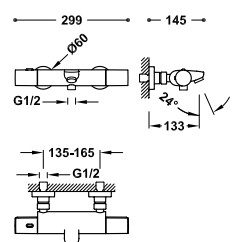

Wall-mounted thermostatic mixer tap for bath and shower

21717419

302,00

- Anti-limescale hand shower (3 funzioni) with directable support. Shower hose. Diverter integrated in the flow control.

Vasca-Doccia termostatica

- Doccetta anticalcare (3 funzioni) con supporto orientabile. Flessibile. Invertitore integrato nel regolatore di portata.



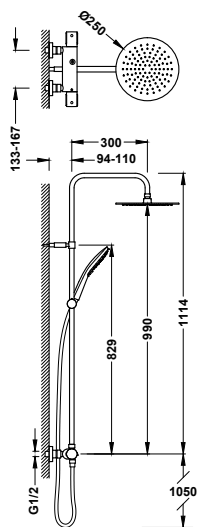

2-way Over-wall thermostatic shower mixer tap set

19039316

464,00

- With diverter integrated into the flow regulator.
- ABS round handle.
- Stainless steel adjustable shower head: 300x300 mm.
- Adjustable and sliding support for hand shower.
- Anti-limescale hand showers: 120x120 mm. (3 stream types).
- Metal hose.

Set di miscelatore termostatico a muro Over-wall 2 getti per doccia

- Con inverter incorporato nel regolatore di flusso.
- Manopola rotonda in ABS.
- Soffione doccia orientabile in acciaio inossidabile: 300x300 mm.
- Supporto scorrevole e orientabile per doccia.
- Doccino anticalcare: 120x120 mm. (3 tipi di getto).
- Flessibile in metallo.



THERMOSTATIC CONCEALED TAPS / RUBINETTI TERMOSTATICI DA INCASSO

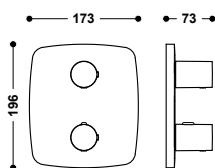

Visible part for concealed 2-way Therm-box

21725001

90,00

Only visible part. ABS round handle. Includes trim plate, control and distribution handle. Complete with concealed Therm-box ref.: 20785001.

Pezzo vista per cassa da incasso a 2 vie Therm-box

Solo parte vista. Manopola rotonda in ABS. Include piastra decorativa, comando e volante distributore. Completare con scatola da incasso Therm-box rif.: 20785001.



Therm-box 2-way concealed box with thermostatic tap for shower and bathtub

20785001

[→ 405](#)

Scatola da incasso a 2 getti Therm-box con miscelatore termostatico per doccia e vasca da bagno

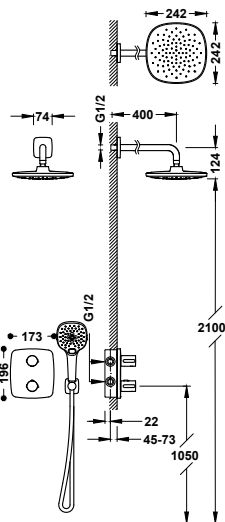

Therm-box 2-way concealed thermostatic tap kit for showers

21725004

512,00

- Concealed body included.
- ABS round handle with temperature control. 2-way ceramic distributor.
- Wall-mounted arm with adjustable shower head: 242x242 mm.
- Wall-mounted support for hand shower with water supply.
- 120x120 mm anti-limescale hand shower. (3 stream types).
- Metal hose.

Kit di miscelatore termostatico da incasso a 2 getti Therm-box per doccia

- Corpo a incasso incluso.
- Manopola rotonda in ABS con controllo della temperatura. Erogatore in ceramica a 2 getti.
- Braccio a muro con soffione doccia orientabile: 242x242 mm.
- Supporto per doccia con presa d'acqua a muro.
- Doccino anticalcare 120x120 mm. (3 tipi di getto).
- Flessibile in metallo.



21725003

482,00

Therm-box 2-way concealed thermostatic tap kit for showers

- Concealed body included.
- ABS round handle with temperature control. 2-way ceramic distributor.
- Ceiling-mounted arm with adjustable shower head: 242x242 mm.
- Wall-mounted support for hand shower with water supply.
- 120x120 mm anti-limescale hand shower. (3 stream types).
- Metal hose.

**Kit di miscelatore termostatico da incasso a 2 getti
Therm-box per doccia**

- Corpo a incasso incluso.
- Manopola rotonda in ABS con controllo della temperatura.
- Erogatore in ceramica a 2 getti.
- Braccio a soffitto con soffione doccia orientabile: 242x242 mm.
- Supporto per doccino con presa d'acqua a muro.
- Doccino anticalcare 120x120 mm. (3 tipi di getto).
- Flessibile in metallo.



21725005

790,00

Therm-box 2-way concealed thermostatic tap kit for showers

- Concealed body included.
- ABS round handle with temperature control. 2-way ceramic distributor.
- Concealed brass ceiling-mounted shower head: Ø 332 mm.
- Wall-mounted support for hand shower with water supply.
- 120x120 mm anti-limescale hand shower. (3 stream types).
- Metal hose.

**Kit di miscelatore termostatico da incasso a 2 getti
Therm-box per doccia**

- Corpo a incasso incluso.
- Manopola rotonda in ABS con controllo della temperatura.
- Erogatore in ceramica a 2 getti.
- Soffione da soffitto a incasso in ottone: Ø 332 mm.
- Supporto per doccino con presa d'acqua a muro.
- Doccino anticalcare 120x120 mm. (3 tipi di getto).
- Flessibile in metallo.

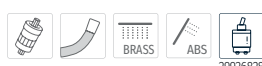

21725006

495,00

Therm-box 2-way concealed thermostatic tap kit for baths and showers

- Concealed body included.
- ABS round handle with temperature control. 2-way ceramic distributor.
- Fixed wall-mounted spout.
- Wall-mounted support for hand shower with water supply.
- 120x120 mm anti-limescale hand shower. (3 stream types).
- Metal hose.

**Kit di miscelatore termostatico da incasso a 2 getti
Therm-box per vasca da bagno e doccia**

- Corpo a incasso incluso.
- Manopola rotonda in ABS con controllo della temperatura.
- Erogatore in ceramica a 2 getti.
- Canna fissa a muro.
- Supporto per doccino con presa d'acqua a muro.
- Doccino anticalcare 120x120 mm. (3 tipi di getto).
- Flessibile in metallo.





CANIGÓ

The Canigó range from Tres boasts water and energy-saving features. Its inclined handle and robust body are integrated into the rounded angles of its contours, providing personality and a distinctive touch to the whole product range.

Tres ha dotato la serie Canigó di caratteristiche che promuovono il risparmio idrico ed energetico. Alla maniglia inclinata e alla solida struttura si aggiunge un profilo dagli angoli arrotondati, che dona un tocco di personalità e singolarità a tutta la serie.







WASHBASIN TAPS / RUBINETTI PER LAVABO

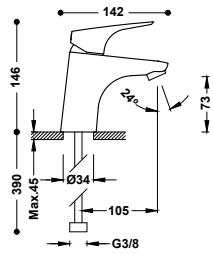

Single-handle washbasin mixer tap

21710303

77,00

G3/8 flexible hoses.

Miscelatore monocomando per lavabo

Flessibili di alimentazione G3/8.

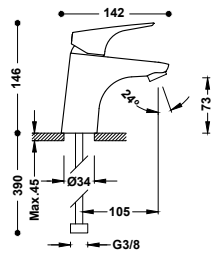

Single-handle washbasin mixer tap with Tres-duo

21710301

79,00

G3/8 flexible hoses.

Miscelatore monocomando per lavabo con Tres-duo

Flessibili di alimentazione G3/8.

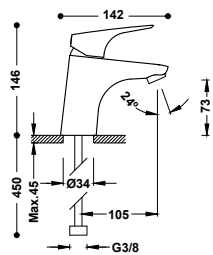

Eco-efficient single-handle washbasin mixer tap

21710401

85,00

G3/8 flexible hoses.

Miscelatore monocomando ecoefficiente per lavabo

Flessibili di alimentazione G3/8.

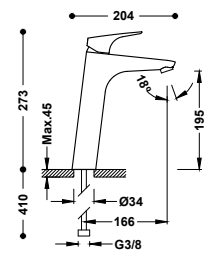

High single-handle washbasin mixer tap with Tres-duo

21720301

144,00

G3/8 flexible hoses.

Miscelatore monocomando alto per lavabo con Tres-duo

Flessibili di alimentazione G3/8.

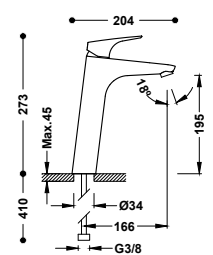

High single-handle washbasin mixer tap

21720303

142,00

G3/8 flexible hoses.

Miscelatore monocomando alto per lavabo

Flessibili di alimentazione G3/8.



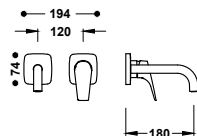

Visible part for recessed sink body

21730021

98,00

Visible part only. Includes concealing plate, handle and 180 mm spout. Recessed body not included.

Elemento a vista per il corpo a incasso da lavello

Solo parte a vista. Include piastra decorativa, comando e beccuccio da 180 mm. Corpo a incasso non incluso.



Recessed body for sink tap

20830002

Corpo a incasso per rubinetto da lavello

→405

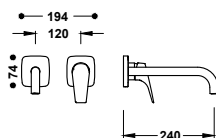

Visible part for recessed sink body

21730022

108,00

Visible part only. Includes concealing plate, handle and 240 mm spout. Recessed body not included.

Elemento a vista per il corpo a incasso da lavello

Solo parte a vista. Include piastra decorativa, comando e beccuccio da 240 mm. Corpo a incasso non incluso.



Recessed body for sink tap

20830002

Corpo a incasso per rubinetto da lavello

→405

BIDET TAPS / RUBINETTI PER BIDET

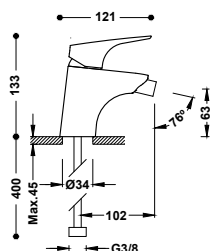

Single-handle bidet mixer tap

21712001

80,00

G3/8 flexible hoses.

Miscelatore monocomando per bidet

Flessibili di alimentazione G3/8.



29903504

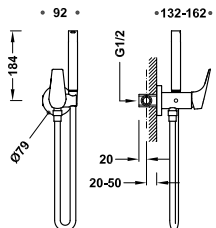

Concealed single lever WC/ bidet mixer

21712301

175,00

With cold and hot water. Hand shower with 5 l/min limiter coupling and non-drip system. Fixed support for hand shower for installation on right or left. Satin hose.

Miscelatore monocomando con doccia per wc

Con acqua fredda e calda. Doccino con limitatore a 5 l/min. e sistema antigocciolamento. Supporto fisso per doccia installabile a destra o a sinistra. Flessibile satinato.



9134591

WALL TAPS / RUBINETTI A MURO

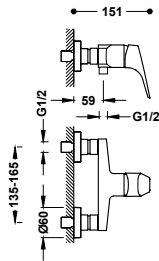

Wall-mounted single-handle shower mixer tap

21726701

82,00

Without accessories.

Miscelatore monocomando a muro per doccia

Senza complementi.



29903504

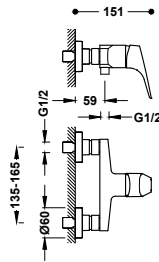

Wall-mounted single-handle shower mixer tap

21716701

103,00

120x120 mm anti-limescale hand shower. (3 stream types). Adjustable support for hand shower. Reinforced metal hose.

Miscelatore monocomando a muro per doccia

Doccino anticalcare 120x120 mm. (3 tipi di getto). Supporto orientabile per doccino. Flessibile rinforzato in metallo.



29903504

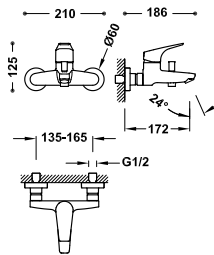

Wall-mounted single-handle mixer tap for bath and shower

21727001

103,00

Without accessories.

Miscelatore monocomando a muro per vasca e doccia

Senza complementi.



29903504

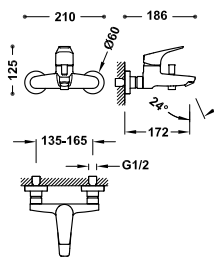

Wall-mounted single-handle mixer tap for bath and shower

21717001

123,00

120x120 mm anti-limescale hand shower. (3 stream types). Adjustable support for hand shower. Reinforced metal hose.

Miscelatore monocomando a muro per vasca e doccia

Doccino anticalcare 120x120 mm. (3 tipi di getto). Supporto orientabile per doccino. Flessibile rinforzato in metallo.



29903504



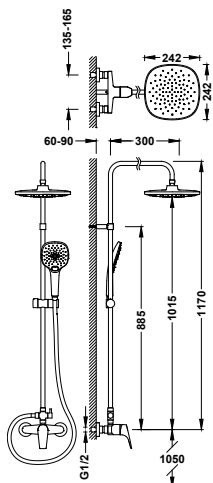

2-way wall-fitted single-handle shower mixer tap

21719101

293,00

- With diverter integrated into the shower bar.
- Adjustable shower head: 242x242 mm.
- Adjustable and sliding support for hand shower.
- 120x120 mm anti-limescale hand shower. (3 stream types).
- Metal hose.

Set miscelatore monocomando a muro 2 getti per doccia

- Con inverter incorporato nella colonna doccia.
- Soffione doccia orientabile: 242x242 mm.
- Supporto scorrevole e orientabile per doccino.
- Doccino anticalcare 120x120 mm. (3 tipi di getto).
- Flessibile in metallo.

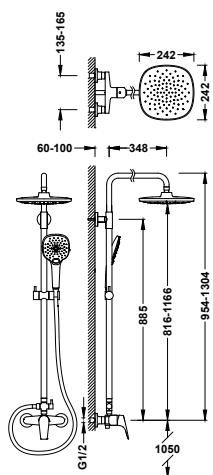

2-way wall-fitted single-handle shower mixer tap

21731221

405,00

- With diverter integrated into the shower bar.
- Telescopic shower bar.
- Adjustable shower head: 242x242 mm.
- Adjustable and sliding support for hand shower.
- 120x120 mm anti-limescale hand shower. (3 stream types).
- Metal hose.

Set miscelatore monocomando a muro 2 getti per doccia

- Con inverter incorporato nella colonna doccia.
- Colonna doccia telescopica.
- Soffione doccia orientabile: 242x242 mm.
- Supporto scorrevole e orientabile per doccino.
- Doccino anticalcare 120x120 mm. (3 tipi di getto).
- Flessibile in metallo.

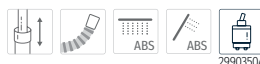

CONCEALED TAPS/ RUBINETTI DA INCASSO

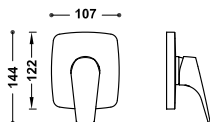

Visible part for concealed 1-way Rapid-box

21727810

63,00

Only visible part. Includes trim plate, control, bush and concealed attachment screw. Complete with concealed Rapid-box ref: 20827810.

Pezzo vista per cassa da incasso a 1 via Rapid-box

Solo parte vista. Include piastra decorativa, comando, boccola e vite di fissaggio occulta. Completare con scatola da incasso Rapid-box rif: 20827810.



Concealed 1-way Rapid-box with single-handle mixer tap for shower

20827810

→405

Scatola da incasso a 1 via Rapid-box con miscelatore monocomando per doccia

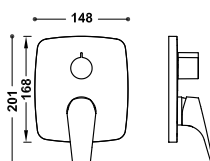

Visible part for concealed 2-way Rapid-box

21728110

79,00

Only visible part. Includes trim plate, control, distribution handle and concealed attachment screw. Complete with concealed Rapid-box ref: 20828110.

Pezzo vista per cassa da incasso a 2 vie Rapid-box

Solo parte vista. Include piastra decorativa, comando, volante distributore e vite di fissaggio occulta. Completare con scatola da incasso Rapid-box rif: 20828110.



Concealed 2-way Rapid-box with single-handle mixer tap for shower and bath

20828110

→405

Scatola da incasso a 2 vie Rapid-box con miscelatore monocomando per doccia e vasca da bagno

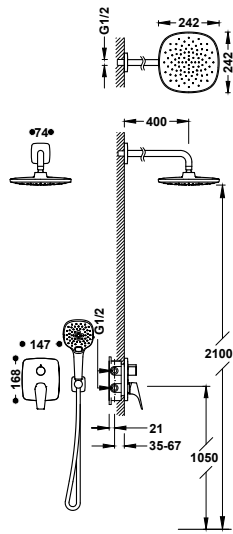

Rapid-box 2-way concealed single-handle shower mixer tap kit

21728004

368,00

- Concealed body included.
- 2-way ceramic distributor.
- Wall-mounted arm with adjustable shower head: 242x242 mm.
- Wall-mounted support for hand shower with water supply.
- 120x120 mm anti-limescale hand shower. (3 stream types).
- Metal hose.

Kit di miscelatore monocomando a incasso 2 getti Rapid-box per doccia

- Corpo a incasso incluso.
- Erogatore in ceramica a 2 getti.
- Braccio a muro con soffione doccia orientabile: 242x242 mm.
- Supporto per doccia con presa d'acqua a muro.
- Doccino anticalcare 120x120 mm. (3 tipi di getto).
- Flessibile in metallo.

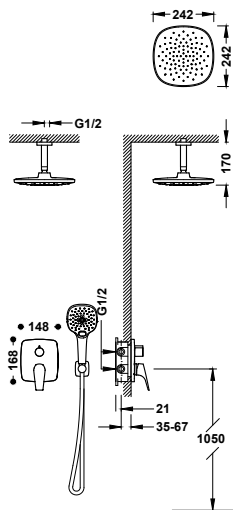

Rapid-box 2-way concealed single-handle shower mixer tap kit

21728003

341,00

- Concealed body included.
- 2-way ceramic distributor.
- Ceiling-mounted arm with adjustable shower head: 242x242 mm.
- Wall-mounted support for hand shower with water supply.
- 120x120 mm anti-limescale hand shower. (3 stream types).
- Metal hose.

Kit di miscelatore monocomando a incasso 2 getti Rapid-box per doccia

- Corpo a incasso incluso.
- Erogatore in ceramica a 2 getti.
- Braccio a soffitto con soffione doccia orientabile: 242x242 mm.
- Supporto per doccia con presa d'acqua a muro.
- Doccino anticalcare 120x120 mm. (3 tipi di getto).
- Flessibile in metallo.

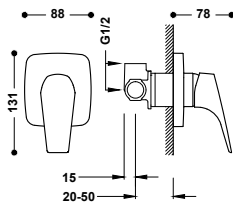
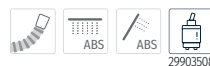

1-way concealed single-handle shower mixer tap

21717701

95,00

- Concealed body included.
- Miscelatore monocomando a incasso 1 getto per doccia**
- Corpo a incasso incluso.

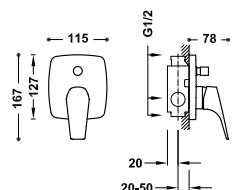

2-way concealed single-handle shower mixer tap

21718001

136,00

- Concealed body included. 2-way diverter.
- Miscelatore monocomando a incasso 2 getti per doccia**
- Corpo a incasso incluso. Inverter a 2 getti.



THERMOSTATIC WALL TAPS / RUBINETTO TERMOSTATICI A MURO

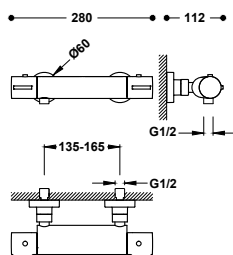

Wall-mounted thermostatic shower mixer tap

21716401

182,00

Without accessories. Round handle.

Miscelatore termostatico a muro per doccia

Senza complementi. Manopola rotonda.

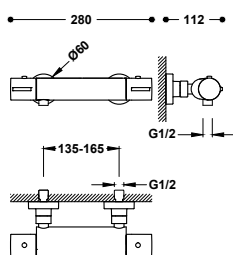

Wall-mounted thermostatic shower mixer tap

21716409

227,00

120x120 mm anti-limescale hand shower. (3 stream types).

Adjustable support for hand shower. Metal hose. Round handle.

Miscelatore termostatico a muro per doccia

Doccino anticalcare 120x120 mm. (3 tipi di getto). Supporto orientabile per doccino. Flessibile in metallo. Manopola rotonda.

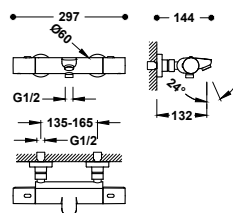

Over-wall thermostatic mixer tap for bath and shower

19017401

243,00

Without accessories. Inverter integrated into the flow regulator. ABS round handle.

Vasca-Doccia termostatica Over-wall

Invertitore integrato nel regolatore di portata. Manopola rotonda in ABS.

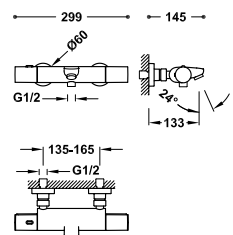

Wall-mounted thermostatic mixer tap for bath and shower

21717419

302,00

Anti-limescale hand shower (3 fonctions) with directable support. Shower hose. Diverter integrated in the flow control.

Vasca-Doccia termostatica

Doccetta anticalcare (3 funzioni) con supporto orientabile. Flessibile. Invertitore integrato nel regolatore di portata.

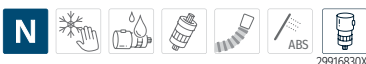

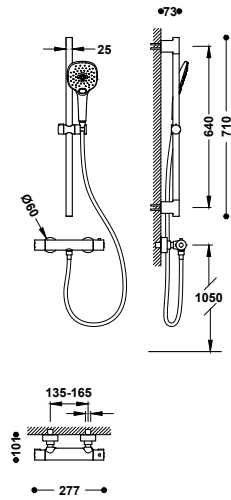

Wall-mounted thermostatic shower mixer tap kit

21738502

259,00

- Shower bar: length 640 mm.
- Adjustable and sliding support for hand shower.
- 120x120 mm anti-limescale hand shower. (3 stream types).
- Metal hose.

Kit di miscelatore termostatico a muro per doccia

- Colonna doccia: lungh. 640 mm.
- Supporto scorrevole e orientabile per doccia.
- Doccino anticalcare 120x120 mm. (3 tipi di getto).
- Flessibile in metallo.

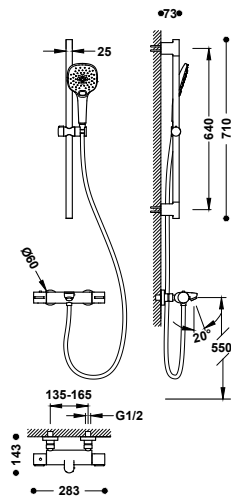

Wall-mounted thermostatic bath and shower mixer tap kit

21738501

312,00

- Shower bar: length 640 mm.
- Adjustable and sliding support for hand shower.
- 120x120 mm anti-limescale hand shower. (3 stream types).
- Metal hose.

Kit di miscelatore termostatico a muro per vasca-Doccia

- Colonna doccia: lungh. 640 mm.
- Supporto scorrevole e orientabile per doccia.
- Doccino anticalcare 120x120 mm. (3 tipi di getto).
- Flessibile in metallo.

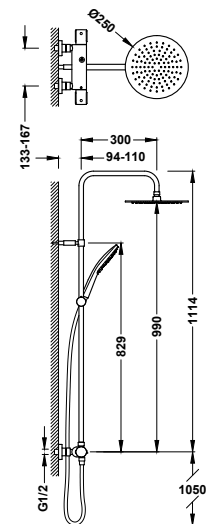

2-way Over-wall thermostatic shower mixer tap set

19039316

464,00

- With diverter integrated into the flow regulator.
- ABS round handle.
- Stainless steel adjustable shower head: 300x300 mm.
- Adjustable and sliding support for hand shower.
- Anti-limescale hand showers: 120x120 mm. (3 stream types).
- Metal hose.

Set di miscelatore termostatico a muro Over-wall 2 getti per doccia

- Con inverter incorporato nel regolatore di flusso.
- Manopola rotonda in ABS.
- Soffione doccia orientabile in acciaio inossidabile: 300x300 mm.
- Supporto scorrevole e orientabile per doccia.
- Doccino anticalcare: 120x120 mm. (3 tipi di getto).
- Flessibile in metallo.



THERMOSTATIC CONCEALED TAPS / RUBINETTI TERMOSTATICI DA INCASSO

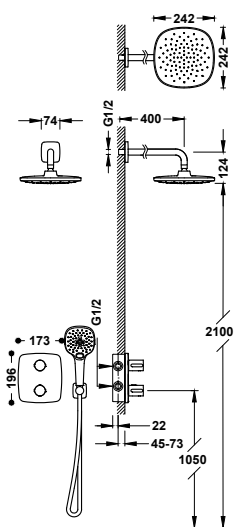

Therm-box 2-way concealed thermostatic tap kit for showers

21725004

512,00

- Concealed body included.
- ABS round handle with temperature control. 2-way ceramic distributor.
- Wall-mounted arm with adjustable shower head: 242x242 mm.
- Wall-mounted support for hand shower with water supply.
- 120x120 mm anti-limescale hand shower. (3 stream types).
- Metal hose.

Kit di miscelatore termostatico da incasso a 2 getti
Therm-box per doccia

- Corpo a incasso incluso.
- Manopola rotonda in ABS con controllo della temperatura.
- Erogatore in ceramica a 2 getti.
- Braccio a muro con soffione doccia orientabile: 242x242 mm.
- Supporto per doccia con presa d'acqua a muro.
- Doccino anticalcare 120x120 mm. (3 tipi di getto).
- Flessibile in metallo.



29926828

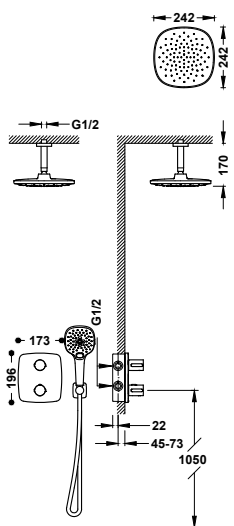

Therm-box 2-way concealed thermostatic tap kit for showers

21725003

482,00

- Concealed body included.
- ABS round handle with temperature control. 2-way ceramic distributor.
- Ceiling-mounted arm with adjustable shower head: 242x242 mm.
- Wall-mounted support for hand shower with water supply.
- 120x120 mm anti-limescale hand shower. (3 stream types).
- Metal hose.

Kit di miscelatore termostatico da incasso a 2 getti
Therm-box per doccia

- Corpo a incasso incluso.
- Manopola rotonda in ABS con controllo della temperatura.
- Erogatore in ceramica a 2 getti.
- Braccio a soffitto con soffione doccia orientabile: 242x242 mm.
- Supporto per doccia con presa d'acqua a muro.
- Doccino anticalcare 120x120 mm. (3 tipi di getto).
- Flessibile in metallo.



29926828





BASE PLUS

The Base Plus series is defined by its simple lines, adaptable to any setting. Its minimalist appearance, as well as its ergonomic control and a body with sinuous, pleasant and clear lines, provide your bathroom with the most essential elements.

La serie Base Plus è caratterizzata da linee semplici e adattabili a qualsiasi ambiente. Il suo aspetto minimalista, un miscelatore ergonomico e un corpo con linee sinuose, armoniche e chiare, permettono di arredare il bagno con elementi essenziali.







WASHBASIN TAPS / RUBINETTI PER LAVABO

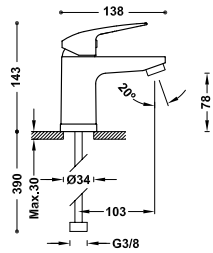

Single-handle washbasin mixer tap

21610303

60,00

G3/8 flexible hoses.

Miscelatore monocomando per lavabo

Flessibili di alimentazione G3/8.

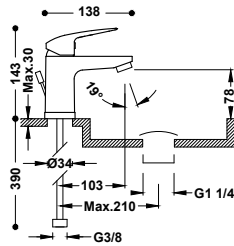

Single-handle mixer tap for washbasin with automatic drainage

21610303DA

74,00

G3/8 flexible hoses.

Miscelatore monocomando per lavabo con scarico automatico

Flessibili di alimentazione G3/8.

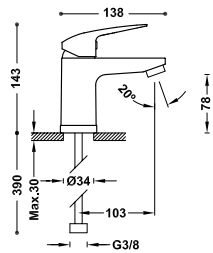

Single-handle washbasin mixer tap

21610303NM

93,00

G3/8 flexible hoses.

Miscelatore monocomando per lavabo

Flessibili di alimentazione G3/8.

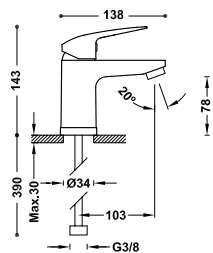

Single-handle washbasin mixer tap with Tres-duo

21610310

62,00

G3/8 flexible hoses.

Miscelatore monocomando per lavabo con Tres-duo

Flessibili di alimentazione G3/8.

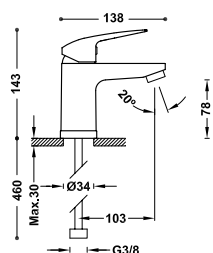

Eco-efficient single-handle washbasin mixer tap

21610410

68,00

G3/8 flexible hoses.

Miscelatore monocomando ecoefficiente per lavabo

Flessibili di alimentazione G3/8.



BIDET TAPS / RUBINETTI PER BIDET

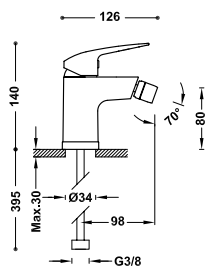

Single-handle bidet mixer tap

21612010

63,00

G3/8 flexible hoses.

Miscelatore monocomando per bidet

Flessibili di alimentazione G3/8.

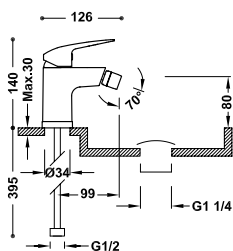

Single-handle bidet mixer tap with automatic drainage

21612010DA

77,00

Adjustable shower head. G3/8 flexible hoses.

Miscelatore monocomando per bidet con scarico automatico

Supporto orientabile. Flessibili di alimentazione G3/8.

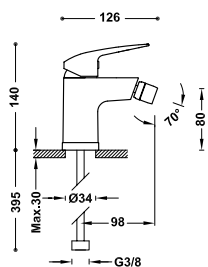

Single-handle bidet mixer tap

21612010NM

97,00

G3/8 flexible hoses.

Miscelatore monocomando per bidet

Flessibili di alimentazione G3/8.



WALL TAPS / RUBINETTI A MURO

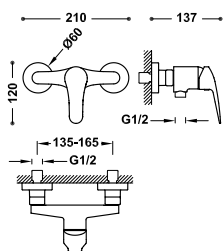

Wall-mounted single-handle shower mixer tap

21626710

75,00

Without accessories.

Miscelatore monocomando a muro per doccia

Senza complementi.

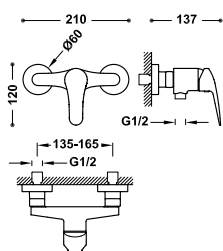

Wall-mounted single-handle shower mixer tap

21616710

89,00

Anti-limescale hand shower. Adjustable support for hand shower. Metal hose.

21616710NM

138,00

Miscelatore monocomando a muro per doccia

Doccino anticalcare. Supporto orientabile per doccino. Flessibile in metallo.



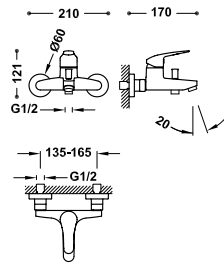

Wall-mounted single-handle mixer tap for bath and shower

21627010

98,00

Without accessories.

Miscelatore monocomando a muro per vasca e doccia

Senza complementi.

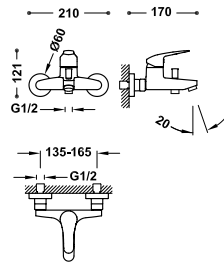

Wall-mounted single-handle mixer tap for bath and shower

21617010

112,00

21617010NM

174,00

Anti-limescale hand shower. Adjustable support for hand shower. Metal hose.

Miscelatore monocomando a muro per vasca e doccia

Doccino anticalcare. Supporto orientabile per doccino. Flessibile in metallo.

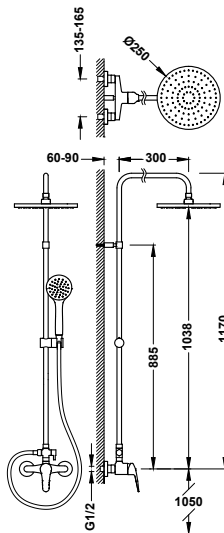

2-way wall-fitted single-handle shower mixer tap

21619110

289,00

- With diverter integrated into the shower bar.
- Adjustable shower head: Ø 250 mm.
- Adjustable and sliding support for hand shower.
- Anti-limescale hand shower.
- Metal hose.

Set miscelatore monocomando a muro 2 getti per doccia

- Con inverter incorporato nella colonna doccia.
- Soffione doccia orientabile: Ø 250 mm.
- Supporto scorrevole e orientabile per doccino.
- Doccino anticalcare.
- Flessibile in metallo.

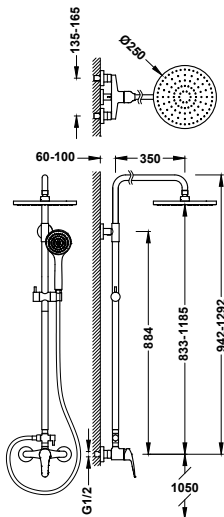

2-way wall-fitted single-handle shower mixer tap

21631221

389,00

- With diverter integrated into the shower bar.
- Adjustable shower head: Ø 250 mm.
- Telescopic shower bar.
- Adjustable and sliding support for hand shower.
- Anti-limescale hand shower.
- Metal hose.

Set miscelatore monocomando a muro 2 getti per doccia

- Con inverter incorporato nella colonna doccia.
- Soffione doccia orientabile: Ø 250 mm.
- Colonna doccia telescopica.
- Supporto scorrevole e orientabile per doccino.
- Doccino anticalcare.
- Flessibile in metallo.



CONCEALED TAPS/ RUBINETTI DA INCASSO

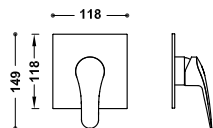

Visible part for concealed 1-way Rapid-box

21627810

58,00

Only visible part. Includes trim plate, control, bush and concealed attachment screw. Complete with concealed Rapid-box ref.: 20827810.

Pezzo vista per cassa da incasso a 1 via Rapid-box

Solo parte vista. Include piastra decorativa, comando, boccola e vite di fissaggio occulta. Completare con scatola da incasso Rapid-box rif.: 20827810.



Concealed 1-way Rapid-box with single-handle mixer tap for shower

20827810

→405

Scatola da incasso a 1 via Rapid-box con miscelatore monocomando per doccia

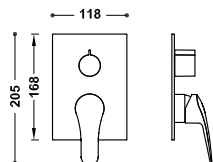

Visible part for concealed 2-way Rapid-box

21628110

74,00

Only visible part. Includes trim plate, control, distribution handle and concealed attachment screw. Complete with concealed Rapid-box ref.: 20828110.

Pezzo vista per cassa da incasso a 2 vie Rapid-box

Solo parte vista. Include piastra decorativa, comando, volante distributore e vite di fissaggio occulta. Completare con scatola da incasso Rapid-box rif.: 20828110.



Concealed 2-way Rapid-box with single-handle mixer tap for shower and bath

20828110

→405

Scatola da incasso a 2 vie Rapid-box con miscelatore monocomando per doccia e vasca da bagno

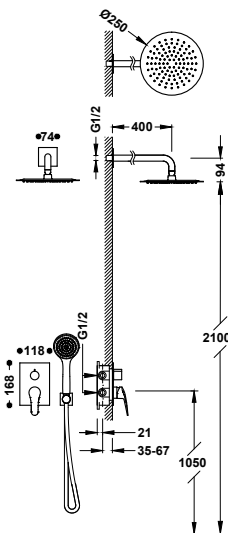

Rapid-box 2-way concealed single-handle shower mixer tap kit

21628004

344,00

- Concealed body included.
- 2-way ceramic distributor.
- Wall-mounted arm with adjustable stainless steel shower head: Ø 250 mm.
- Wall-mounted support for hand shower with water supply.
- Anti-limescale hand showers: Ø 100 mm.
- Metal hose.

Kit di miscelatore monocomando a incasso 2 getti Rapid-box per doccia

- Corpo a incasso incluso.
- Erogatore in ceramica a 2 getti.
- Braccio a muro con soffione doccia orientabile in acciaio inossidabile: Ø 250 mm.
- Supporto per doccia con presa d'acqua a muro.
- Doccino anticalcare: Ø 100 mm.
- Flessibile in metallo.



29903508

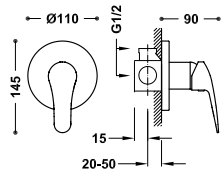

1-way concealed single-handle shower mixer tap
Concealed body included.

■ 21617701 90,00

Miscelatore monocomando a incasso 1 getto per doccia
Corpo a incasso incluso.

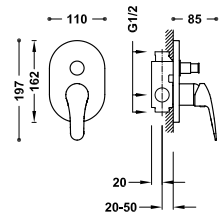

2-way concealed single-handle shower mixer tap
Concealed body included. 2-way diverter.

■ 21618001 126,00

Miscelatore monocomando a incasso 2 getti per doccia
Corpo a incasso incluso. Inverter a 2 getti.



THERMOSTATIC WALL TAPS / RUBINETTO TERMOSTATICI A MURO

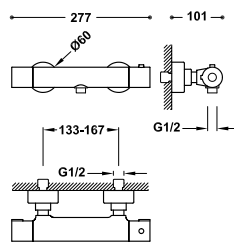

Wall-mounted thermostatic shower mixer tap
Without accessories.

■ 21616401 139,00
■ 21616401NM 215,00

Miscelatore termostatico a muro per doccia
Senza complementi.

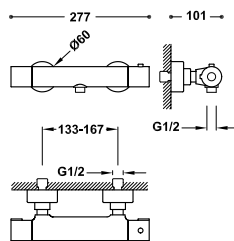

Wall-mounted thermostatic shower mixer tap
Anti-limescale: Ø 100 mm hand shower. Adjustable support for hand shower. Metal hose.

■ 21616409 153,00
■ 21616409NM 238,00

Miscelatore termostatico a muro per doccia
Doccino anticalcare: Ø 100 mm. Supporto orientabile per doccia. Flessibile in metallo.

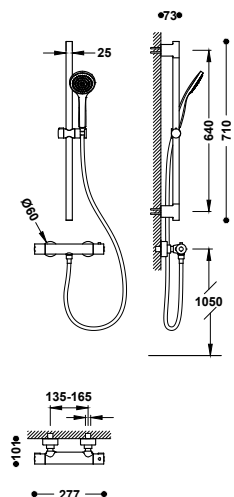

Wall-mounted thermostatic shower mixer tap kit
· Shower bar: length 640 mm.
· Adjustable and sliding support for hand shower.
· Anti-limescale hand showers: Ø 100 mm.
· Metal hose.

■ 21619601 249,00
■ 21619601NM 363,00

Kit di miscelatore termostatico a muro per doccia
· Colonna doccia: lungh. 640 mm.
· Supporto scorrevole e orientabile per doccia.
· Doccino anticalcare: Ø 100 mm.
· Flessibile in metallo.



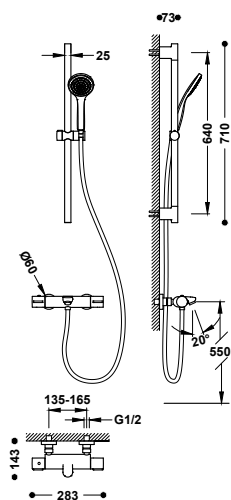

Wall-mounted thermostatic bath and shower mixer tap kit

21619602

302,00

- Shower bar: length 640 mm.
- Adjustable and sliding support for hand shower.
- Anti-limescale hand showers: \varnothing 100 mm.
- Metal hose.

Kit di miscelatore termostatico a muro per vasca-Doccia

- Colonna doccia: lungh. 640 mm.
- Supporto scorrevole e orientabile per doccia.
- Doccino anticalcare: \varnothing 100 mm.
- Flessibile in metallo.

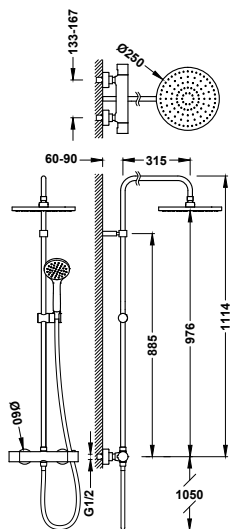

2-way wall-mounted thermostatic shower mixer tap set

21639301

315,00

- With diverter integrated into the flow regulator.
- ABS round handle.
- Adjustable shower head: \varnothing 250 mm.
- Adjustable and sliding support for hand shower.
- Anti-limescale hand showers: \varnothing 100 mm.
- Metal hose.

Set di miscelatore termostatico a muro 2 getti per doccia

- Con inverter incorporato nel regolatore di flusso.
- Manopola rotonda in ABS.
- Soffione doccia orientabile: \varnothing 250 mm.
- Supporto scorrevole e orientabile per doccia.
- Doccino anticalcare: \varnothing 100 mm.
- Flessibile in metallo.

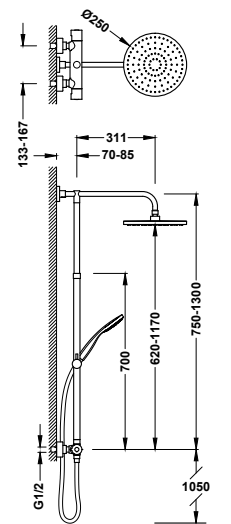

2-way wall-mounted thermostatic shower mixer tap set

21639302NM

488,00

- With diverter integrated into the flow regulator.
- ABS round handle.
- Shower bar with an adjustable length.
- Adjustable shower head: \varnothing 250 mm.
- Adjustable and sliding support for hand shower.
- Anti-limescale hand showers: \varnothing 100 mm.
- Satin hose.

Set di miscelatore termostatico a muro 2 getti per doccia

- Con inverter incorporato nel regolatore di flusso.
- Manopola rotonda in ABS.
- Asta doccia di lunghezza variabile fino al relativo fissaggio.
- Soffione doccia orientabile: \varnothing 250 mm.
- Supporto scorrevole e orientabile per doccia.
- Doccino anticalcare: \varnothing 100 mm.
- Flessibile satinato.



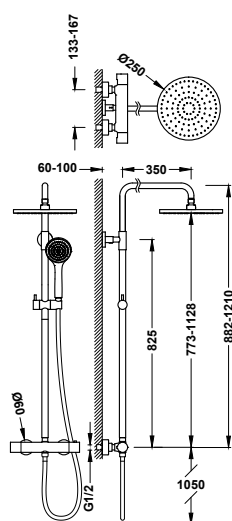

2-way wall-mounted thermostatic shower mixer tap set

21639521

405,00

- With diverter integrated into the flow regulator.
- ABS round handle.
- Telescopic shower bar.
- Adjustable shower head: Ø 250 mm.
- Adjustable and sliding support for hand shower.
- Anti-limescale hand showers: Ø 100 mm.
- Metal hose.

Set di miscelatore termostatico a muro 2 getti per doccia

- Con inverter incorporato nel regolatore di flusso.
- Manopola rotonda in ABS.
- Colonna doccia telescopica.
- Soffione doccia orientabile: Ø 250 mm.
- Supporto scorrevole e orientabile per doccino.
- Doccino anticalcare: Ø 100 mm.
- Flessibile in metallo.

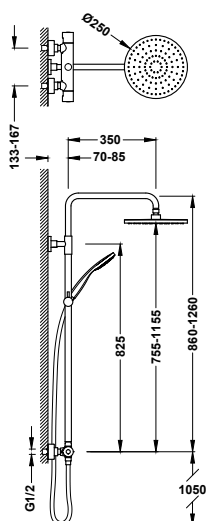

2-way wall-mounted thermostatic shower mixer tap set

21639502NM

628,00

- With diverter integrated into the flow regulator.
- Telescopic shower bar.
- Adjustable shower head: Ø 250 mm.
- Adjustable and sliding support for hand shower.
- Anti-limescale hand showers: Ø 100 mm.
- Satin hose.

Set di miscelatore termostatico a muro 2 getti per doccia

- Con inverter incorporato nel regolatore di flusso.
- Colonna doccia telescopica.
- Soffione doccia orientabile: Ø 250 mm.
- Supporto scorrevole e orientabile per doccino.
- Doccino anticalcare: Ø 100 mm.
- Flessibile satinato.



THERMOSTATIC CONCEALED TAPS / RUBINETTI TERMOSTATICI DA INCASSO

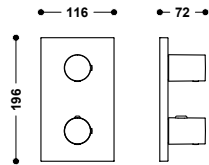

Visible part for concealed 2-way Thermostat

Only visible part. ABS round handle. Includes trim plate, control and distribution handle. Complete with concealed Thermostat ref.: 20785001.

■	21625001	85,00
■	21625001NM	130,00

Pezzo vista per cassa da incasso a 2 vie Thermostat

Solo parte vista. Manopola rotonda in ABS. Include piastra decorativa, comando e volante distributore. Completare con scatola da incasso Thermostat ref.: 20785001.



Thermostat 2-way concealed box with thermostatic tap for shower and bathtub

20785001

[↗405](#)

Scatola da incasso a 2 getti Thermostat con miscelatore termostatico per doccia e vasca da bagno

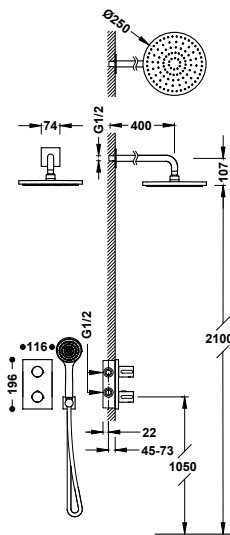

Thermostat 2-way concealed thermostatic tap kit for showers

- Concealed body included.
- ABS round handle with temperature control. 2-way ceramic distributor.
- Wall-mounted arm with adjustable shower head: Ø 250 mm.
- Wall-mounted support for hand shower with water supply.
- Anti-limescale hand shower.
- Metal hose.

■	21625004	498,00
■	21625004NM	772,00

Kit di miscelatore termostatico da incasso a 2 getti Thermostat per doccia

- Corpo a incasso incluso.
- Manopola rotonda in ABS con controllo della temperatura. Erogatore in ceramica a 2 getti.
- Braccio a muro con soffione doccia orientabile: Ø 250 mm.
- Supporto per doccia con presa d'acqua a muro.
- Doccino anticalcare.
- Flessibile in metallo.







BASE

With the Base series, you can equip your bathroom with the essentials, since each tap in this series fulfils a function and has been designed to combine efficiency and safety with simplicity of operation. Base is basically simple. Basically unique.









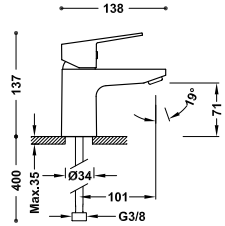

Con la serie Base si può arredare il bagno con gli elementi essenziali, poiché ogni rubinetto di questa serie svolge la sua funzione ed è stato pensato per combinare efficienza e sicurezza con la semplicità e la funzionalità. Base è essenzialmente semplice. Semplicemente unica.

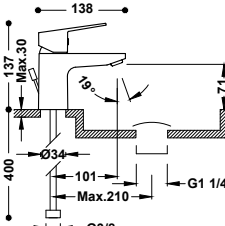

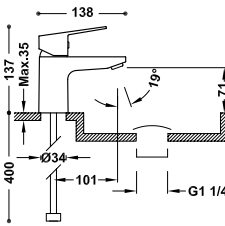

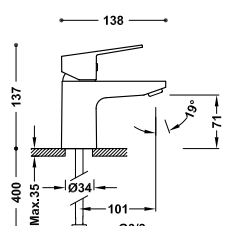

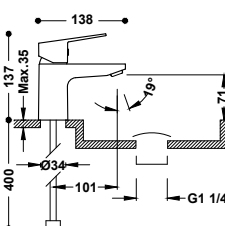
WASHBASIN TAPS / RUBINETTI PER LAVABO

		<p>Single-handle washbasin mixer tap G3/8 flexible hoses.</p> <p>Miscelatore monocomando per lavabo Flessibili di alimentazione G3/8.</p>	<p>21510303 53,00</p> 
		<p>Single-handle mixer tap for washbasin with automatic drainage G3/8 flexible hoses.</p> <p>Miscelatore monocomando per lavabo con scarico automatico Flessibili di alimentazione G3/8.</p>	<p>21510303DA 69,00</p> 
		<p>Single-handle washbasin mixer tap with Click-clack automatic drainage G3/8 flexible hoses.</p> <p>Miscelatore monocomando per lavabo con valvola scarico Click-clack Flessibili di alimentazione G3/8.</p>	<p>21510303D 63,00</p> 
		<p>Single-handle washbasin mixer tap with Tres-duo G3/8 flexible hoses.</p> <p>Miscelatore monocomando per lavabo con Tres-duo Flessibili di alimentazione G3/8.</p>	<p>21510310 56,00</p> 
		<p>Single-handle washbasin mixer tap with Tres-duo and Click-clack automatic drainage G3/8 flexible hoses.</p> <p>Miscelatore monocomando per lavabo con Tres-duo e valvola scarico Click-clack Flessibili di alimentazione G3/8.</p>	<p>21510310D 66,00</p> 



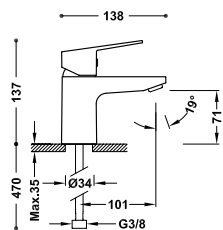

Eco-efficient single-handle washbasin mixer tap

21510410

62,00

G3/8 flexible hoses.

Miscelatore monocomando ecoefficiente per lavabo

Flessibili di alimentazione G3/8.



29903505

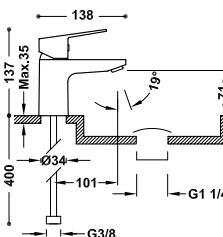

Eco-efficient single-handle washbasin mixer tap with Click-clack automatic drainage valve

21510410D

72,00

G3/8 flexible hoses.

Miscelatore monocomando ecoefficiente per lavabo con valvola scarico Click-clack

Flessibili di alimentazione G3/8.



29903505

BIDET TAPS / RUBINETTI PER BIDET

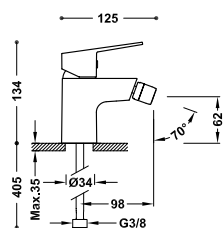

Single-handle bidet mixer tap

21512010

56,00

G3/8 flexible hoses.

Miscelatore monocomando per bidet

Flessibili di alimentazione G3/8.



29903504

IA

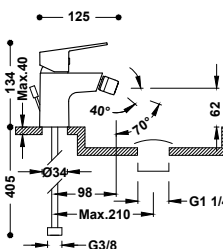

Single-handle bidet mixer tap with automatic drainage

21512010DA

70,00

Adjustable shower head. G3/8 flexible hoses.

Miscelatore monocomando per bidet con scarico automatico

Supporto orientabile. Flessibili di alimentazione G3/8.



29903504

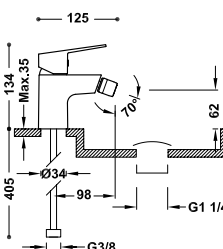

Single-handle bidet mixer tap with Click-clack automatic drainage

21512010D

66,00

G3/8 flexible hoses.

Miscelatore monocomando per bidet con valvola scarico Click-clack

Flessibili di alimentazione G3/8.



29903504

WALL TAPS / RUBINETTI A MURO

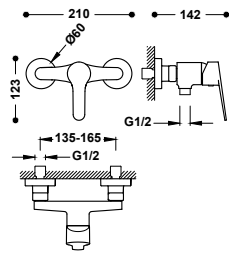

Wall-mounted single-handle shower mixer tap

21526710

72,00

Without accessories.

Miscelatore monocomando a muro per doccia

Senza complementi.

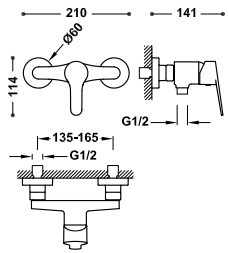

Wall-mounted single-handle shower mixer tap

21516710

87,00

Anti-limescale hand shower. Articulated support for hand shower. Metal hose.

Miscelatore monocomando a muro per doccia

Doccino anticalcare. Supporto articolato per doccino. Flessibile in metallo.

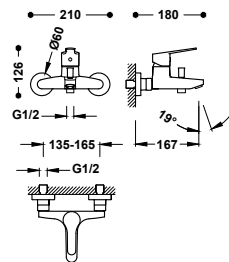

Wall-mounted single-handle mixer tap for bath and shower

21527010

88,00

Without accessories.

Miscelatore monocomando a muro per vasca e doccia

Senza complementi.

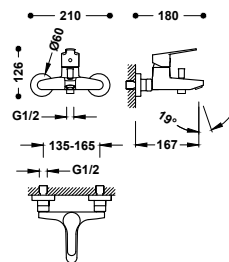

Wall-mounted single-handle mixer tap for bath and shower

21517010

102,00

Anti-limescale hand shower. Articulated support for hand shower. Metal hose.

Miscelatore monocomando a muro per vasca e doccia

Doccino anticalcare. Supporto articolato per doccino. Flessibile in metallo.



CONCEALED TAPS/ RUBINETTI DA INCASSO

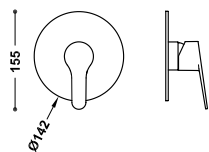

Visible part for concealed 1-way Rapid-box

21527810

58,00

Only visible part. Includes trim plate, control, bush and concealed attachment screw. Complete with concealed Rapid-box ref.: 20827810.

Pezzo vista per cassa da incasso a 1 via Rapid-box

Solo parte vista. Include piastra decorativa, comando, boccola e vite di fissaggio occulta. Completare con scatola da incasso Rapid-box rif.: 20827810.



Concealed 1-way Rapid-box with single-handle mixer tap for shower

20827810

405

Scatola da incasso a 1 via Rapid-box con miscelatore monocomando per doccia

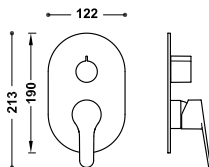

Visible part for concealed 2-way Rapid-box

21528110

74,00

Only visible part. Includes trim plate, control, distribution handle and concealed attachment screw. Complete with concealed Rapid-box ref.: 20828110.

Pezzo vista per cassa da incasso a 2 vie Rapid-box

Solo parte vista. Include piastra decorativa, comando, volante distributore e vite di fissaggio occulta. Completare con scatola da incasso Rapid-box rif.: 20828110.



Concealed 2-way Rapid-box with single-handle mixer tap for shower and bath

20828110

405

Scatola da incasso a 2 vie Rapid-box con miscelatore monocomando per doccia e vasca da bagno

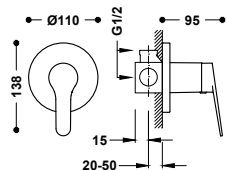

1-way concealed single-handle shower mixer tap

21517701

82,00

Concealed body included.

Miscelatore monocomando a incasso 1 via per doccia

Corpo a incasso incluso.

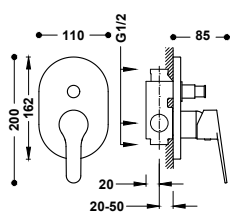

2-way concealed single-handle shower mixer tap

21518001

118,00

Concealed body included. 2-way diverter.

Miscelatore monocomando a incasso 2 vie per doccia

Corpo a incasso incluso. Inverter a 2 getti.



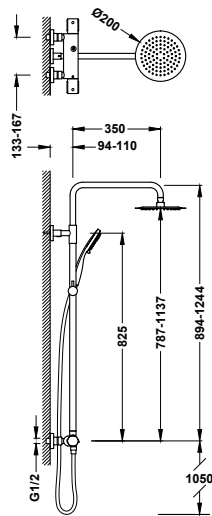

2-way Over-wall thermostatic shower mixer tap set

19038710

420,00

- With diverter integrated into the flow regulator.
- Telescopic shower bar.
- ABS round handle.
- Stainless steel adjustable shower head: Ø200 mm.
- Adjustable and sliding support for hand shower.
- Anti-limescale hand showers: Ø100 mm. (3 stream types).
- Metal hose.

Set di miscelatore termostatico a muro Over-wall 2 getti per doccia

- Con inverter incorporato nel regolatore di flusso.
- Colonna doccia telescopica.
- Manopola rotonda in ABS.
- Soffione doccia orientabile in acciaio inossidabile: Ø200 mm.
- Supporto scorrevole e orientabile per doccia.
- Doccino anticalcare: Ø100 mm. (3 tipi di getto).
- Flessibile in metallo.



29916831

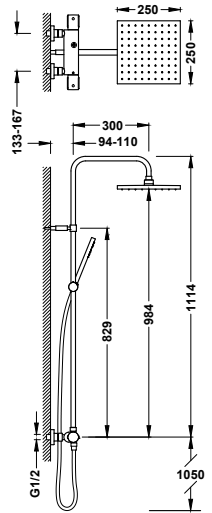

2-way Over-wall thermostatic shower mixer tap set

19039317

429,00

- With diverter integrated into the flow regulator.
- ABS round handle.
- Stainless steel adjustable shower head: 250x250 mm.
- Adjustable and sliding support for hand shower.
- Anti-limescale hand shower.
- Metal hose.

Set di miscelatore termostatico a muro Over-wall 2 getti per doccia

- Con inverter incorporato nel regolatore di flusso.
- Manopola rotonda in ABS.
- Soffione doccia orientabile: 250x250 mm.
- Supporto scorrevole e orientabile per doccia.
- Doccino anticalcare
- Flessibile in metallo.



29916831

THERMOSTATIC CONCEALED TAPS / RUBINETTI TERMOSTATICI DA INCASSO

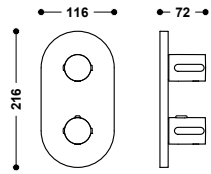

Visible part for concealed 2-way Therm-box

21525001

85,00

Only visible part. ABS round handle. Includes trim plate, control and distribution handle. Complete with concealed Therm-box ref: 20785001.

Pezzo vista per cassa da incasso a 2 vie Therm-box

Solo parte vista. Manopola rotonda in ABS. Include piastra decorativa, comando e volante distributore. Completare con scatola da incasso Therm-box rif: 20785001.



Therm-box 2-way concealed box with thermostatic tap for shower and bathtub

20785001

→405

Scatola da incasso a 2 getti Therm-box con miscelatore termostatico per doccia e vasca da bagno

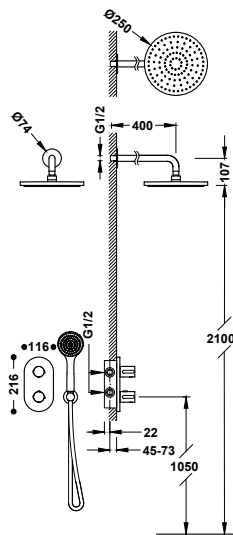

Therm-box 2-way concealed thermostatic tap kit for showers

21525004

435,00

- Concealed body included.
- ABS round handle with temperature control. 2-way ceramic distributor.
- Wall-mounted arm with adjustable shower head: Ø 250 mm.
- Wall-mounted support for hand shower with water supply.
- Anti-limescale hand shower.
- Metal hose.

Kit di miscelatore termostatico da incasso a 2 getti Therm-box per doccia

- Corpo a incasso incluso.
- Manopola rotonda in ABS con controllo della temperatura. Ergatore in ceramica a 2 getti.
- Braccio a muro con soffione doccia orientabile: Ø 250 mm.
- Supporto per doccia con presa d'acqua a muro.
- Doccino anticalcare.
- Flessibile in metallo.

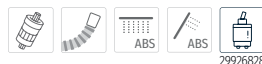

29926828



ESE-23

The Ese-23 two-handle series is an affordable alternative to basic tapware. Its retro handles, with hot and cold water indicators, and its compact body are the talking points of this range which contains all the basics needed for installation in a house.

La serie a doppio comando Ese-23 è l'alternativa economica alla rubinetteria di base. Volanti retró con indicatori di acqua calda o fredda e corpi dedicati caratterizzano una serie con i pezzi principali per una casa.





WASHBASIN TAPS / RUBINETTI PER LAVABO

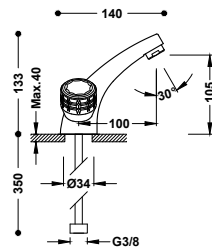

Two-handle washbasin mixer tap
G3/8 flexible hoses.

123103

108,00

Miscelatore bicomando per lavabo
Flessibili di alimentazione G3/8.



9134284

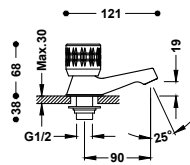

Washbasin tap with 1 water outlet

123100F

36,00

G1/2 male threaded connection. With blue indicator.

123100C

36,00

Rubinetto monoacqua per lavabo
Attacco filettato maschio da G1/2.



9134284

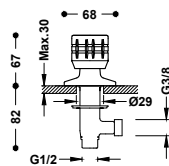

Lateral washbasin tap without spout

123510F

59,00

With blue indicator.

123510C

59,00

Miscelatore laterale senza canna per lavabo



9134285

BIDET TAPS / RUBINETTI PER BIDET

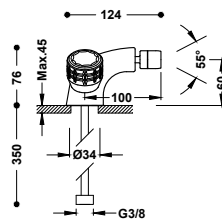

Two-handle bidet mixer tap

123120

111,00

G3/8 flexible hoses.

Miscelatore bicomando per bidet

Flessibili di alimentazione G3/8.



9134284

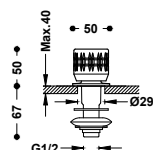

Lateral bidet tap without spout

123125F

40,00

G1/2 male threaded connection.

123125C

40,00

Miscelatore laterale senza canna per bidet

Attacco filettato maschio da G1/2.



9134284

WALL TAPS / RUBINETTI A MURO

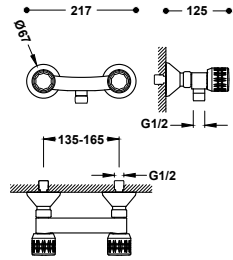

Wall-mounted two-handle shower mixer tap

123167

118,00

Anti-limescale hand shower. Adjustable support for hand shower. Reinforced metal hose.

Miscelatore bicomando a muro per doccia

Doccino anticalcare. Supporto orientabile per doccia. Flessibile rinforzato in metallo.



9134284

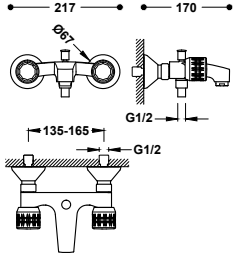

Wall-mounted two-handle mixer tap for bath and shower

123170

160,00

Anti-limescale hand shower. Adjustable support for hand shower. Reinforced metal hose.

Miscelatore bicomando a muro per vasca e doccia

Doccino anticalcare. Supporto orientabile per doccia. Flessibile rinforzato in metallo.



9134284

TAPS FOR VARIOUS USES / RUBINETTI PER USI DIVERSI

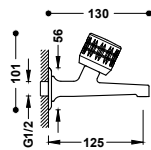

Wall-mounted tap with 1 water outlet for office or utility room

* 123520F

36,00

* 123520C

36,00

G1/2 male threaded connection.

Miscelatore a muro per o zona pranzo o lavatoio

Attacco filettato maschio da G1/2.



9134283

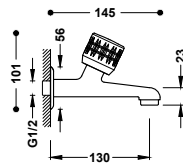

Wall-mounted tap with 1 water outlet for office or utility room

* 02352001F

43,00

* 02352001C

43,00

G1/2 male threaded connection.

Miscelatore a muro per o zona pranzo o lavatoio

Attacco filettato maschio da G1/2.



9134283

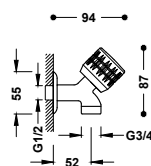

Wall-mounted tap with 1 water outlet for washing machine

* 123500F

25,00

* 123500C

25,00

G1/2 male threaded connection.

Miscelatore monoacqua a muro per lavatrice

Attacco filettato maschio da G1/2.



9134283



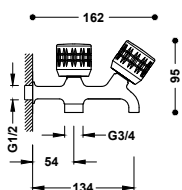

Double wall-mounted tap with 1 water outlet for washing machine

123515

43,00

Outlet 1: Male threaded connection: 3/4". Outlet 2: to utility room.

Miscelatore monoacqua doppio a muro per lavatrice

Uscita 1: Attacco filettato maschio: 3/4". Uscita 2: a lavatoio.



9134283

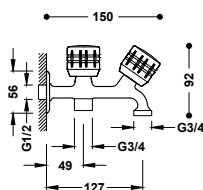

Double wall-mounted tap with 1 water outlet for washing machine

02351501

46,00

Outlets 1 and 2: Male threaded connection: 3/4".

Miscelatore monoacqua doppio a muro per lavatrice

Uscita 1 e 2: Attacco filettato maschio: 3/4".



9134283

SHUT-OFF VALVES / VALVOLE DI INTERCETTAZIONE

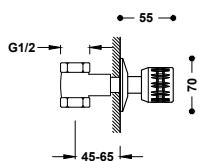

Concealed shut-off valve 1/2"

* 123155F

33,00

Female threaded connection: 1/2".

* 123155C

33,00

Valvola di intercettazione a incasso 1/2"

Attacco filettato femmina: 1/2".



9134286

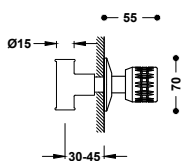

Concealed shut-off valve Ø 15 mm.

* 123511F

31,00

Female welded connection: Ø 15 mm.

* 123511C

31,00

Valvola di intercettazione a incasso Ø 15 mm.

Attacco saldato femmina: Ø 15 mm.



9134286

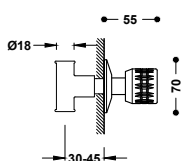

Concealed shut-off valve Ø 18 mm.

* 123512F

30,00

Female welded connection: Ø 18 mm.

* 123512C

30,00

Valvola di intercettazione a incasso Ø 18 mm.

Attacco saldato femmina: Ø 18 mm.



9134286

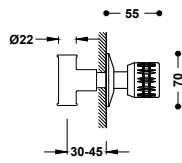

Concealed shut-off valve \varnothing 22 mm.
Female welded connection: \varnothing 22 mm.

Valvola di intercettazione a incasso \varnothing 22 mm.
Attacco saldato femmina: \varnothing 22 mm.

* 123513F 29,00
* 123513C 29,00

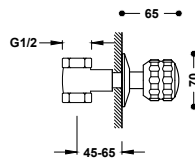

Concealed shut-off valve 1/2"

Female threaded connection: 1/2".
Valvola di intercettazione a incasso 1/2"
Attacco filettato femmina: 1/2".

* 13315510F 62,00
* 13315510C 62,00

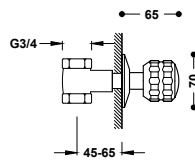

Concealed shut-off valve 3/4"

Female threaded connection: 3/4".
Valvola di intercettazione a incasso 3/4"
Attacco filettato femmina: 3/4".

* 13315710F 74,00
* 13315710C 74,00

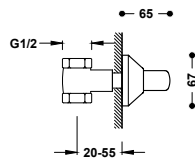

Concealed shut-off valve with hidden regulation 1/2"

Female threaded connection: 1/2".
Valvola di intercettazione a incasso con regolazione occulta 1/2"
Attacco filettato femmina: 1/2".

133516 56,00

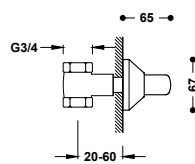

Concealed shut-off valve with hidden regulation 3/4"

Female threaded connection: 3/4".
Valvola di intercettazione a incasso con regolazione occulta 3/4"
Attacco filettato femmina: 3/4".

133517 58,00





SHOWER AREA *SPAZIO DOCCIA*

ELECTRONIC *ELETTRONICI*

258 Shower Technology

THERMOSTATIC *TERMOSTATICI*

270 Concealed B-system
Incassati B-system

280 Concealed Therm-box
Incassati Therm-box

294 Surface-mounted Over-wall
Da appoggio Over-wall

SINGLE-LEVER MIXER TAPS *MONOCOMANDI*

318 Concealed Rapid-box
Incassati Rapid-box

338 Surface-mounted
Da appoggio



SHOWER TECHNOLOGY

Fitting your bath or shower with Shower technology will bring you nothing but joy. Tres has updated its electronic innovation to give you absolute control in the shower. The shower is at the user's disposal with new capacities that increase safety, water savings and convenience when showering, with everything ready and waiting.

Dotare la doccia o la vasca da bagno di Showertechnology sarà una vera soddisfazione. Tres ha migliorato l'innovazione elettronica per avere un controllo assoluto della doccia. La doccia è al servizio dell'utente in quanto integra nuove funzionalità per aumentarne la sicurezza, risparmiare acqua e avere la comodità di fare la doccia quando tutto è pronto.







SHOWER TECHNOLOGY

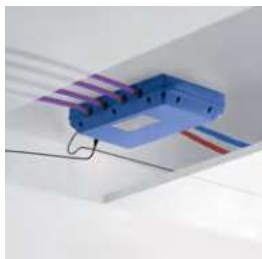
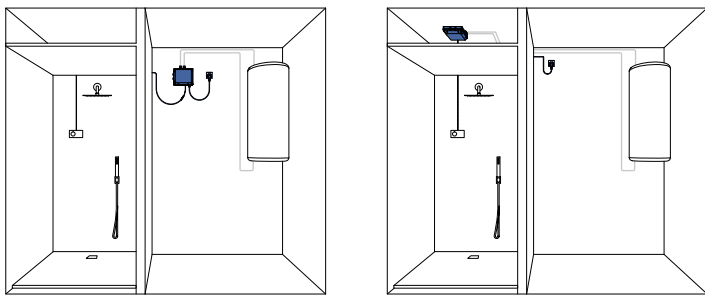

The electronic thermostatic control unit can be installed up to a **maximum distance of 10 metres** from the control screen.

La centralina termostatica elettronica può essere installata fino ad un **massimo di 10 metri** di distanza dal display di controllo.



The temperature is at 38°C when the tap is initially turned on. The maximum limit is 46°C. The selected temperature level is indicated by numbers and a color scale.

Quando viene aperto inizialmente, la temperatura è di 38°C. Il limite massimo è di 46°C. Il livello della temperatura selezionata verrà indicato numericamente e con una scala di colori.



Totally **waterproof and anti-humidity** built-in system with Schlüter seals. Sistema incassato, totalmente **a tenuta stagna e anti-umidità** con giunti Schlüter.



The tap stops when it reaches the programmed temperature and the shower is ready for you to enter whenever you like.

Il rubinetto si chiude quando viene raggiunta la temperatura programmata e la doccia è pronta al tuo ingresso.



The control screen is completely **watertight**, the active buttons are illuminated and it comes in a white or black finish.

Lo schermo di controllo è totalmente **ermetico**, con illuminazione dei pulsanti attivati e finitura in bianco o nero.



Includes a program to **prevent legionella** (5 minutes at 60°C), or to disinfect directly (10 minutes at 60°C).

*Dotato di un programma per **prevenire la legionella** (5 minuti a 60°C) o direttamente per disinfettare (10 minuti a 60°C).*

2-WAY KITS / KIT A 2 GETTI

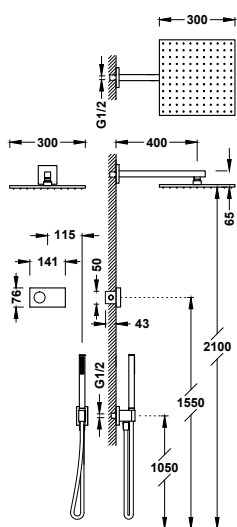

Shower technology 2-way concealed electronic thermostatic shower tap kit

- Electronic control included with Schlüter anti-moisture seals.
- Electronic thermostatic control box included (2-way).
- Wall-mounted arm with adjustable stainless steel shower head: 300x300 mm.
- Wall-mounted support for hand shower with water supply.
- Anti-limescale brass hand shower.
- Satin hose.

Kit di miscelatore termostatico elettronico a incasso 2 getti Shower technology per doccia

- Controllo elettronico incluso con guarnizioni antimidità Schlüter.
- Centralina elettronica termostatica inclusa (2 getti).
- Braccio a muro con soffione doccia orientabile in acciaio inossidabile: 300x300 mm.
- Supporto per doccia con presa d'acqua a muro.
- Doccino anticalcare in ottone.
- Flessibile satinato.



- 09286563 1.242,00
- 09286563OM 1.831,00
- 09286563OPM 1.831,00



- 09288563NM 1.346,00

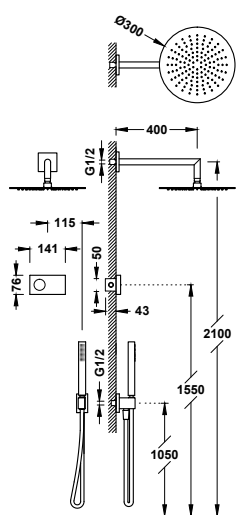

Shower technology 2-way concealed electronic thermostatic shower tap kit

- Electronic control included with Schlüter anti-moisture seals.
- Electronic thermostatic control box included (2-way).
- Wall-mounted arm with adjustable stainless steel shower head: Ø 300 mm.
- Wall-mounted support for hand shower with water supply.
- Anti-limescale brass hand shower.
- Satin hose.

Kit di miscelatore termostatico elettronico a incasso 2 getti Shower technology per doccia

- Controllo elettronico incluso con guarnizioni antimidità Schlüter.
- Centralina elettronica termostatica inclusa (2 getti).
- Braccio a muro con soffione doccia orientabile in acciaio inossidabile: Ø 300 mm.
- Supporto per doccia con presa d'acqua a muro.
- Doccino anticalcare in ottone.
- Flessibile satinato.



- 09286558 1.195,00
- 09286558OM 1.766,00
- 09286558OPM 1.766,00



- 09288558NM 1.301,00

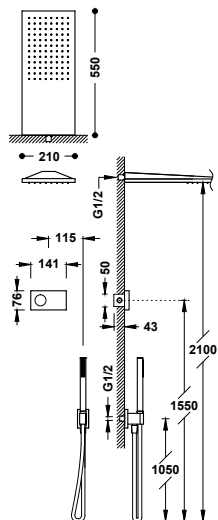

Shower technology 2-way concealed electronic thermostatic shower tap kit

- Electronic control included with Schlüter anti-moisture seals.
- 2-way electronic thermostatic control box included.
- Stainless steel wall-mounted shower head: 210x550 mm.
- Wall-mounted support for hand shower with water supply.
- Anti-limescale brass hand shower.
- Satin hose.

Kit di miscelatore termostatico elettronico a incasso 2 getti Shower technology per doccia

- Controllo elettronico incluso con guarnizioni antimidità Schlüter.
- Centralina elettronica termostatica inclusa a 2 getti.
- Soffione doccia a muro in acciaio inossidabile: 210x550 mm.
- Supporto per doccia con presa d'acqua a muro.
- Doccino anticalcare in ottone.
- Flessibile satinato.



- 09286551 1.384,00
- 09286551OM 2.357,00
- 09286551OPM 2.357,00



- 09288551NM 1.718,00



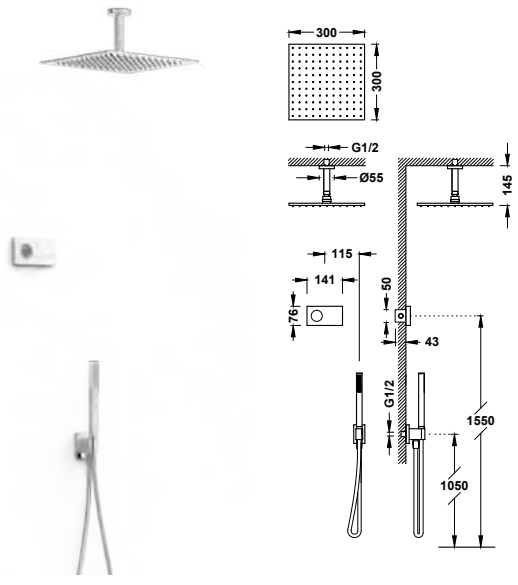

Shower technology 2-way concealed electronic thermostatic shower tap kit

- Electronic control included with Schlüter anti-moisture seals.
- Electronic thermostatic control box included (2-way).
- Ceiling-mounted arm with adjustable stainless steel shower head: 300x300 mm.
- Wall-mounted support for hand shower with water supply.
- Anti-limescale brass hand shower.
- Satin hose.

	09286564	1.190,00
	092865640M	1.757,00
	092865640PM	1.757,00



	09288564NM	1.296,00
--	------------	----------



Kit di miscelatore termostatico elettronico a incasso 2 getti Shower technology per doccia

- Controllo elettronico incluso con guarnizioni antiumidità Schlüter.
- Centralina elettronica termostatica inclusa (2 getti).
- Braccio a soffitto con soffione doccia orientabile in acciaio inossidabile: 300x300 mm.
- Supporto per doccia con presa d'acqua a muro.
- Doccino anticalcare in ottone.
- Flessibile satinato.

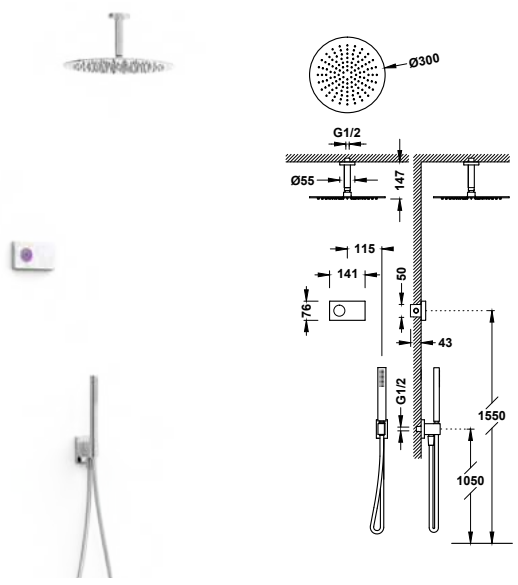

Shower technology 2-way concealed electronic thermostatic shower tap kit

- Electronic control included with Schlüter anti-moisture seals.
- Electronic thermostatic control box included (2-way).
- Ceiling-mounted arm with adjustable stainless steel shower head: Ø 300 mm.
- Wall-mounted support for hand shower with water supply.
- Anti-limescale brass hand shower.
- Satin hose.

	09286567	1.181,00
	092865670M	1.692,00
	092865670PM	1.692,00



	09288567NM	1.250,00
--	------------	----------



Kit di miscelatore termostatico elettronico a incasso 2 getti Shower technology per doccia

- Controllo elettronico incluso con guarnizioni antiumidità Schlüter.
- Centralina elettronica termostatica inclusa (2 getti).
- Braccio a soffitto con soffione doccia orientabile in acciaio inossidabile: Ø 300 mm.
- Supporto per doccia con presa d'acqua a muro.
- Doccino anticalcare in ottone.
- Flessibile satinato.

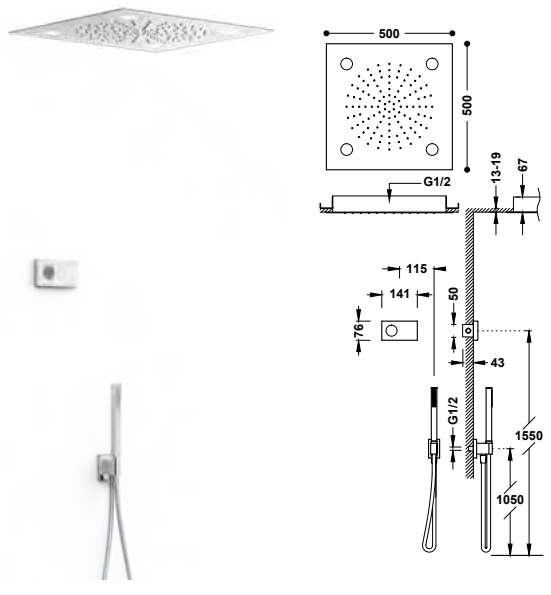

Shower technology 2-way concealed electronic thermostatic shower tap with Chromotherapy kit

- Electronic control included with Schlüter anti-moisture seals.
- Electronic thermostatic control box included (2-way).
- Concealed stainless steel ceiling-mounted shower head with Chromotherapy: 500x500 mm
- Wall-mounted support for hand shower with water connection.
- Anti-limescale brass hand shower.
- Satin hose.

	09286562	2.064,00
--	----------	----------



Kit di miscelatore termostatico elettronico a incasso 2 getti Shower technology con Cromoterapia per doccia

- Controllo elettronico incluso con guarnizioni antiumidità Schlüter.
- Centralina elettronica termostatica inclusa (2 getti).
- Soffione doccia da soffitto a incasso con Cromoterapia in acciaio inossidabile: 500x500 mm
- Supporto per doccia con presa d'acqua a muro.
- Doccino anticalcare in ottone.
- Flessibile satinato.



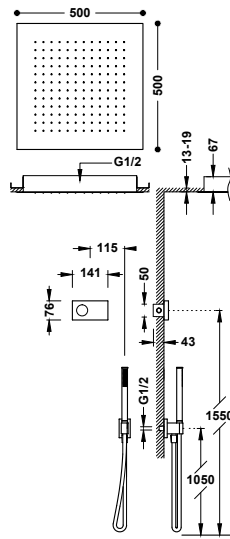

Shower technology 2-way concealed electronic thermostatic shower tap kit

- Electronic control included with Schlüter anti-moisture seals.
- Electronic thermostatic control box included (2-way).
- Concealed stainless steel ceiling-mounted shower head: 500x500 mm.
- Wall-mounted support for hand shower with water supply.
- Anti-limescale brass hand shower.
- Satin hose.

Kit di miscelatore termostatico elettronico a incasso 2 getti Shower technology per doccia

- Controllo elettronico incluso con guarnizioni antimidità Schlüter.
- Centralina elettronica termostatica inclusa (2 getti).
- Soffione doccia soffitto a incasso in acciaio inossidabile: 500x500 mm.
- Supporto per doccia con presa d'acqua a muro.
- Doccino anticalcare in ottone.
- Flessibile satinato.



09286561 1.766,00



09288561NM 2.310,00

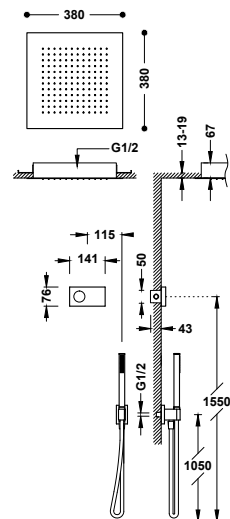

Shower technology 2-way concealed electronic thermostatic shower tap kit

- Electronic control included with Schlüter anti-moisture seals.
- Electronic thermostatic control box included (2-way).
- Concealed stainless steel ceiling-mounted shower head: 380x380 mm.
- Wall-mounted support for hand shower with water supply.
- Anti-limescale brass hand shower.
- Satin hose.

Kit di miscelatore termostatico elettronico a incasso 2 getti Shower technology per doccia

- Controllo elettronico incluso con guarnizioni antimidità Schlüter.
- Centralina elettronica termostatica inclusa (2 getti).
- Soffione doccia soffitto a incasso in acciaio inossidabile: 380x380 mm.
- Supporto per doccia con presa d'acqua a muro.
- Doccino anticalcare in ottone.
- Flessibile satinato.



09286552 1.617,00



09288552NM 2.050,00

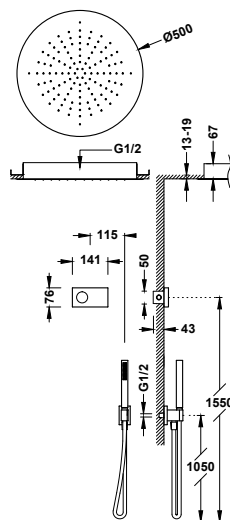

Shower technology 2-way concealed electronic thermostatic shower tap kit

- Electronic control included with Schlüter anti-moisture seals.
- Electronic thermostatic control box included (2-way).
- Concealed stainless steel ceiling-mounted shower head: Ø 500 mm.
- Wall-mounted support for hand shower with water supply.
- Anti-limescale brass hand shower.
- Satin hose.

Kit di miscelatore termostatico elettronico a incasso 2 getti Shower technology per doccia

- Controllo elettronico incluso con guarnizioni antimidità Schlüter.
- Centralina elettronica termostatica inclusa (2 getti).
- Soffione doccia soffitto a incasso in acciaio inossidabile: Ø 500 mm.
- Supporto per doccia con presa d'acqua a muro.
- Doccino anticalcare in ottone.
- Flessibile satinato.



09286557 1.766,00



09288557NM 2.300,00



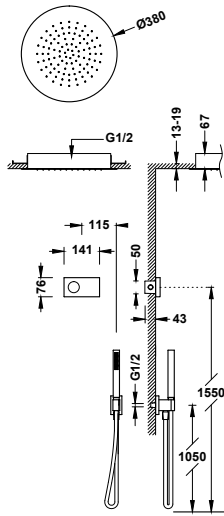

Shower technology 2-way concealed electronic thermostatic shower tap kit

- Electronic control included with Schlüter anti-moisture seals.
- Electronic thermostatic control box included (2-way).
- Concealed stainless steel ceiling-mounted shower head: Ø 380 mm.
- Wall-mounted support for hand shower with water supply.
- Anti-limescale brass hand shower.
- Satin hose.

09286555 1.592,00



09288555NM 2.039,00



Kit di miscelatore termostatico elettronico a incasso 2 getti Shower technology per doccia

- Controllo elettronico incluso con guarnizioni antiumidità Schlüter.
- Centralina elettronica termostatica inclusa (2 getti).
- Soffione doccia soffitto a incasso in acciaio inossidabile: Ø 380 mm.
- Supporto per doccia con presa d'acqua a muro.
- Doccino anticalcare in ottone.
- Flessibile satinato.

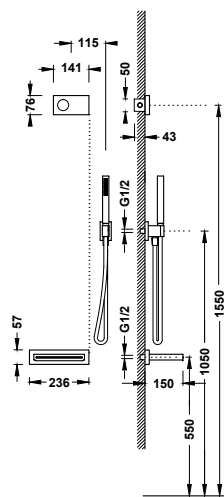

Shower technology 2-way concealed electronic thermostatic tap kit for bath and shower

- Electronic control included with Schlüter anti-moisture seals.
- Electronic thermostatic control box included (2-way).
- Fixed wall-mounted spout with cascade outlet.
- Wall-mounted support for hand shower with water supply.
- Anti-limescale brass hand shower.
- Satin hose.

09286556 1.294,00



09288556NM 1.577,00



Kit di miscelatore termostatico elettronico a incasso 2 getti Shower technology per vasca e doccia

- Controllo elettronico incluso con guarnizioni antiumidità Schlüter.
- Centralina elettronica termostatica inclusa (2 getti).
- Canna fissa a muro con getto a cascata.
- Supporto per doccia con presa d'acqua a muro.
- Doccino anticalcare in ottone.
- Flessibile satinato.



3-WAY KITS / KIT A 3 GETTI

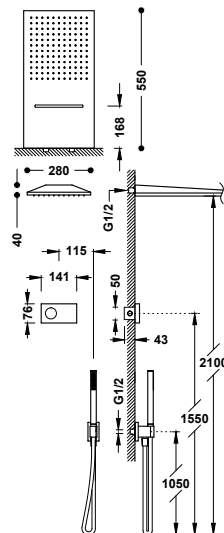

Shower technology 3-way concealed electronic thermostatic shower tap kit

- Electronic control included with Schlüter anti-moisture seals.
- Electronic thermostatic control box included (3-way).
- Stainless steel wall-mounted shower head with 2 stream types (rain/cascade). 280x550 mm. IMPORTANT: Install a >50 l/min drain.
- Wall-mounted support for hand shower with water supply.
- Anti-limescale brass hand shower.
- Satin hose.

09286308 1.611,00

092863080M 2.727,00

092863080PM 2.727,00



09288308NM 1.978,00



Kit di miscelatore termostatico elettronico a incasso 3 getti Shower technology per doccia

- Controllo elettronico incluso con guarnizioni antiumidità Schlüter.
- Centralina elettronica termostatica inclusa (3 getti).
- Soffione doccia a muro in acciaio inossidabile con 2 tipi di getto (pioggia/cascata). 280x550 mm. IMPORTANTE: Montare uno scarico da >50 l/min.
- Supporto per doccia con presa d'acqua a muro.
- Doccino anticalcare in ottone.
- Flessibile satinato.



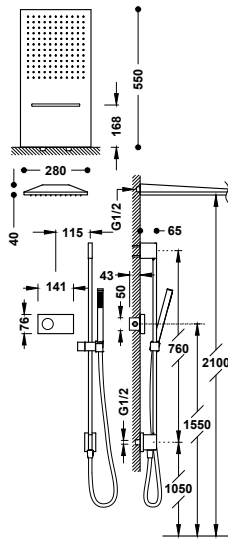

Shower technology 3-way concealed electronic thermostatic shower tap kit

09286307

1.678,00



- Electronic control included with Schlüter anti-moisture seals.
- Electronic thermostatic control box included (3-way).
- Stainless steel wall-mounted shower head with 2 stream types (rain/cascade). 280x550 mm. IMPORTANT: Install a >50 l/min drain.
- Sliding shower bar with wall water supply.
- Anti-limescale brass hand shower.
- Satin hose.

Kit di miscelatore termostatico elettronico a incasso 3 getti Shower technology per doccia

- Controllo elettronico incluso con guarnizioni antiumidità Schlüter.
- Centralina elettronica termostatica inclusa (3 getti).
- Soffione doccia a muro in acciaio inossidabile con 2 tipi di getto (pioggia/cascata). 280x550 mm. IMPORTANTE: Montare uno scarico da >50 l/min.
- Colonna scorrevole per doccia con presa d'acqua a muro.
- Doccino anticalcare in ottone.
- Flessibile satinato.

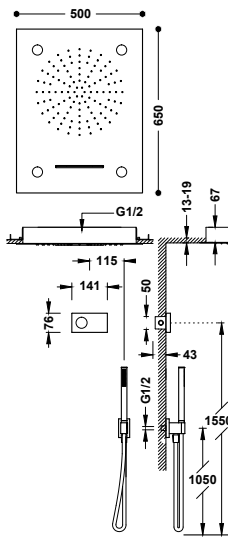

Shower technology 3-way concealed electronic thermostatic shower tap with Chromotherapy kit

09286302

3.005,00



- Electronic control included with Schlüter anti-moisture seals.
- Electronic thermostatic control box included (3-way).
- Stainless steel concealed ceiling-mounted shower head with Chromotherapy and 2 stream types (rain/cascade). 500x650 mm. IMPORTANT: Install a >50 l/min drain.
- Wall-mounted support for hand shower with water supply.
- Anti-limescale brass hand shower.
- Satin hose.

Kit di miscelatore termostatico elettronico a incasso 3 getti Shower technology con Cromoterapia per doccia

- Controllo elettronico incluso con guarnizioni antiumidità Schlüter.
- Centralina elettronica termostatica inclusa (3 getti).
- Soffione doccia a incasso da soffitto con Cromoterapia in acciaio inossidabile con 2 tipi di getto (pioggia/cascata). 500x650 mm. IMPORTANTE: Montare uno scarico da >50 l/min.
- Supporto per doccia con presa d'acqua a muro.
- Doccino anticalcare in ottone.
- Flessibile satinato.

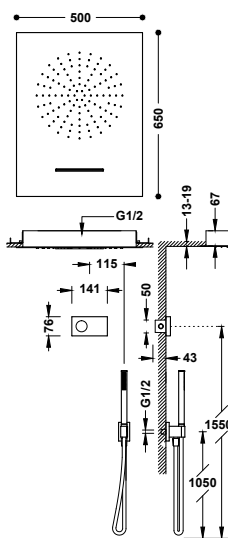

Shower technology 3-way concealed electronic thermostatic shower tap kit

09286304

2.249,00



- Electronic control included with Schlüter anti-moisture seals.
- Electronic thermostatic control box included (3-way).
- Stainless steel concealed ceiling-mounted shower head with 2 stream types (rain/cascade). 500x650 mm. IMPORTANT: Install a >50 l/min drain.
- Wall-mounted support for hand shower with water supply.
- Anti-limescale brass hand shower.
- Satin hose.

Kit di miscelatore termostatico elettronico a incasso 3 getti Shower technology per doccia

- Controllo elettronico incluso con guarnizioni antiumidità Schlüter.
- Centralina elettronica termostatica inclusa (3 getti).
- Soffione doccia a incasso da soffitto in acciaio inossidabile con 2 tipi di getto (pioggia/cascata). 500x650 mm. IMPORTANTE: Montare uno scarico da >50 l/min.
- Supporto per doccia con presa d'acqua a muro.
- Doccino anticalcare in ottone.
- Flessibile satinato.



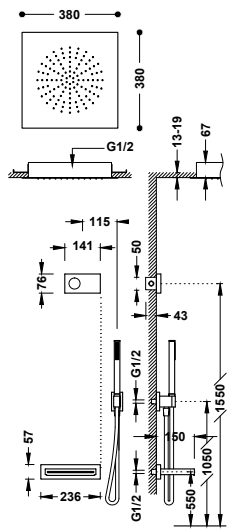

Shower technology 3-way concealed electronic thermostatic tap kit for bath and shower

- Electronic control included with Schlüter anti-moisture seals.
- Electronic thermostatic control box included (3-way).
- Concealed stainless steel ceiling-mounted shower head: 380x380 mm. **IMPORTANT:** Install a >50 l/min drain.
- Fixed wall-mounted spout with cascade outlet.
- Wall-mounted support for hand shower with water supply.
- Anti-limescale brass hand shower.
- Satin hose.

09286315 2.006,00



09288315NM 2.649,00



Kit di miscelatore termostatico elettronico a incasso 3 getti Shower technology per vasca e doccia

- Controllo elettronico incluso con guarnizioni antiumidità Schlüter.
- Centralina elettronica termostatica inclusa (3 getti).
- Soffione doccia soffitto a incasso in acciaio inossidabile: 380x380 mm. **IMPORTANTE:** Montare uno scarico da >50 l/min.
- Canna fissa a muro con getto a cascata.
- Supporto per doccino con presa d'acqua a muro.
- Doccino anticalcare in ottone.
- Flessibile satinato.



4-WAY KITS / KIT A 4 GETTI

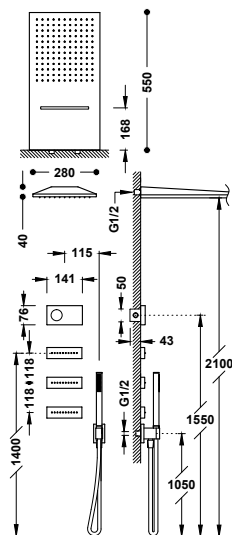

Shower technology 4-way concealed electronic thermostatic shower tap kit

- Electronic control included with Schlüter anti-moisture seals.
- Electronic thermostatic control box included (4-way).
- Stainless steel wall-mounted shower head with 2 stream types (rain/cascade). 280x550 mm. **IMPORTANT:** Install a >50 l/min drain.
- 3 concealed brass hydromassage jets.
- Wall-mounted support for hand shower with water supply.
- Anti-limescale brass hand shower.
- Satin hose.

09286408 2.224,00



09288408NM 2.896,00



Kit di miscelatore termostatico elettronico a incasso 4 getti Shower technology per doccia

- Controllo elettronico incluso con guarnizioni antiumidità Schlüter.
- Centralina elettronica termostatica inclusa (4 getti).
- Soffione doccia a muro in acciaio inossidabile con 2 tipi di getto (pioggia/cascata). 280x550 mm. **IMPORTANTE:** Montare uno scarico da >50 l/min.
- 3 getti idromassaggio a incasso in ottone.
- Supporto per doccino con presa d'acqua a muro.
- Doccino anticalcare in ottone.
- Flessibile satinato.

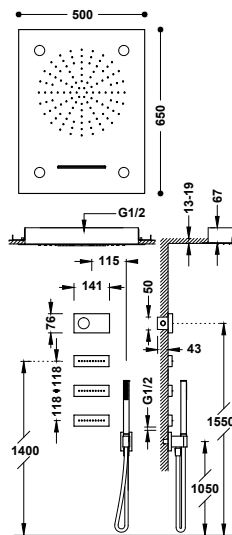

Shower technology 4-way concealed electronic thermostatic shower tap with Chromotherapy kit

- Electronic control included with Schlüter anti-moisture seals.
- Electronic thermostatic control box included (4-way).
- Stainless steel concealed ceiling-mounted shower head with Chromotherapy and 2 stream types (rain/cascade). 500x650 mm. **IMPORTANT:** Install a >50 l/min drain.
- 3 concealed brass hydromassage jets.
- Wall-mounted support for hand shower with water supply.
- Anti-limescale brass hand shower.
- Satin hose.

09286402 3.618,00



Kit di miscelatore termostatico elettronico a incasso 4 getti Shower technology con Cromoterapia per doccia

- Controllo elettronico incluso con guarnizioni antiumidità Schlüter.
- Centralina elettronica termostatica inclusa (4 getti).
- Soffione doccia a incasso da soffitto con Cromoterapia in acciaio inossidabile con 2 tipi di getto (pioggia/cascata). 500x650 mm. **IMPORTANTE:** Montare uno scarico da >50 l/min.
- 3 getti idromassaggio a incasso in ottone.
- Supporto per doccino con presa d'acqua a muro.
- Doccino anticalcare in ottone.
- Flessibile satinato.



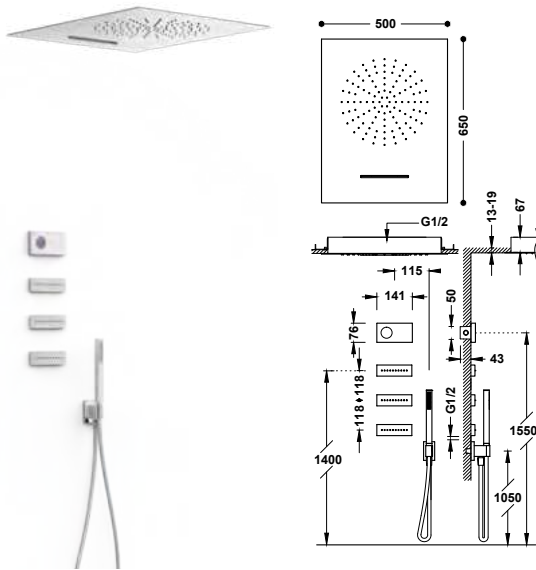

Shower technology 4-way concealed electronic thermostatic shower tap kit

- Electronic control included with Schlüter anti-moisture seals.
- Electronic thermostatic control box included (4-way).
- Stainless steel concealed ceiling-mounted shower head with 2 stream types (rain/cascade). 500x650 mm. IMPORTANT: Install a >50 l/min drain.
- 3 concealed brass hydromassage jets.
- Wall-mounted support for hand shower with water supply.
- Anti-limescale brass hand shower.
- Satin hose.

Kit di miscelatore termostatico elettronico a incasso 4 getti Shower technology per doccia

- Controllo elettronico incluso con guarnizioni anti-umidità Schlüter.
- Centralina elettronica termostatica inclusa (4 getti).
- Soffione doccia a incasso da soffitto in acciaio inossidabile con 2 tipi di getto (pioggia/cascata). 500x650 mm. IMPORTANTE: Montare uno scarico da >50 l/min.
- 3 getti idromassaggio a incasso in ottone.
- Supporto per doccia con presa d'acqua a muro.
- Doccino anticalcare in ottone.
- Flessibile satinato.



09286404 2.862,00



09288404NM 3.756,00



CONTROL SCREEN / PANNELLO DI COMANDO

COMPLETE YOUR ELECTRONIC SHOWER
COMPLETA LA TUA DOCCIA ELETTRONICA

Buy the screen with your thermostatic control panel and complete your shower with the fixtures you need based on the number of water outlets you have chosen.

Compra lo schermo con centralina termostatica e completa la doccia con gli elementi di cui hai bisogno a seconda della quantità di vie d'acqua che hai scelto.

* The installation of Tres shower accessories is required to ensure proper functionality.
* L'installazione degli accessori per doccia Tres è obbligatoria per garantirne il corretto funzionamento.

	+				
492 862 99 - 492 882 99	•	•			
492 863 98 - 492 883 98	•	•			•
492 863 99 - 492 883 99	•	•	•		
492 864 99 - 492 884 99	•	•	•	•	•
		-371 -395	-354	-398	-499

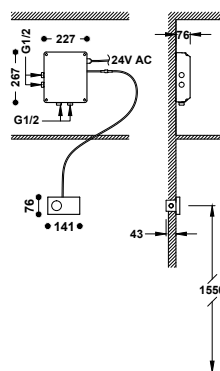

Shower technology 2-way concealed electric thermostatic control

- Electronic control included with Schlüter anti-moisture seals.
- Electronic thermostatic control box included (2-way).
- Minimum available temperature lower than 25°C.
- Tuning system: Preparation of the desired temperature.
- With anti-legionella programmes.
- * NOTE: A spray nozzle, shower head, jet or bath spout must be added to the order, depending on installation type.

Controllo elettronico termostatico a incasso 2 getti Shower technology

- Controllo elettronico incluso con guarnizioni anti-umidità Schlüter.
- Centralina elettronica termostatica inclusa (2 getti).
- Temperatura minima disponibile inferiore a 25°C.
- Sistema di messa a punto: Preparazione della temperatura desiderata.
- Con programma antilegionella.

* NOTA: è obbligatorio aggiungere all'ordine un soffione, doccia a mano, bocchette o una canna per vasca da bagno, a seconda del tipo di installazione.



49286299 * 1.040,00

49288299 * 1.040,00



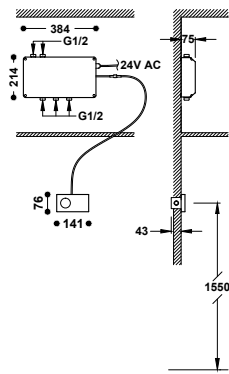

Shower technology 3-way concealed electric thermostatic control

	49286398 *	1.113,00
	49288398 *	1.113,00

- Electronic control included with Schlüter anti-moisture seals.
- Electronic thermostatic control box included (3-way).
- Minimum available temperature lower than 25°C.
- Tuning system: Preparation of the desired temperature.
- With anti-legionella programmes.
- * NOTE: A spray nozzle, shower head, jet or bath spout must be added to the order, depending on installation type.

Controllo elettronico termostatico a incasso 3 getti Shower technology

- Controllo elettronico incluso con guarnizioni antiumidità Schlüter.
- Centralina elettronica termostatica inclusa (3 getti).
- Temperatura minima disponibile inferiore a 25°C.
- Sistema di messa a punto: Preparazione della temperatura desiderata.
- Con programma antilegionella.
- * NOTA: è obbligatorio aggiungere all'ordine un soffione, doccia a mano, bocchette o una canna per vasca da bagno, a seconda del tipo di installazione.

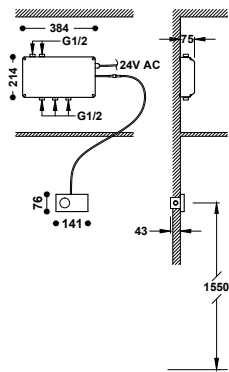
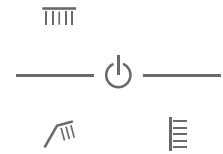

Shower technology 3-way concealed electric thermostatic control

	49286399 *	1.113,00
	49288399 *	1.113,00

- Electronic control included with Schlüter anti-moisture seals.
- Electronic thermostatic control box included (3-way).
- Minimum available temperature lower than 25°C.
- Tuning system: Preparation of the desired temperature.
- With anti-legionella programmes.
- * NOTE: A spray nozzle, shower head, jet or bath spout must be added to the order, depending on installation type.

Controllo elettronico termostatico a incasso 3 getti Shower technology

- Controllo elettronico incluso con guarnizioni antiumidità Schlüter.
- Centralina elettronica termostatica inclusa (3 getti).
- Temperatura minima disponibile inferiore a 25°C.
- Sistema di messa a punto: Preparazione della temperatura desiderata.
- Con programma antilegionella.
- * NOTA: è obbligatorio aggiungere all'ordine un soffione, doccia a mano, bocchette o una canna per vasca da bagno, a seconda del tipo di installazione.

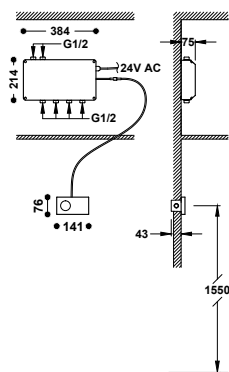
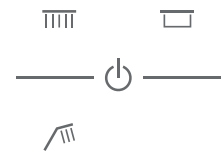

Shower technology 4-way concealed electric thermostatic control

	49286499 *	1.187,00
	49288499 *	1.187,00

- Electronic control included with Schlüter anti-moisture seals.
- Electronic thermostatic control box included (4-way).
- Minimum available temperature lower than 25°C.
- Tuning system: Preparation of the desired temperature.
- With anti-legionella programmes.
- * NOTE: A spray nozzle, shower head, jet or bath spout must be added to the order, depending on installation type.

Controllo elettronico termostatico a incasso 4 getti Shower technology

- Controllo elettronico incluso con guarnizioni antiumidità Schlüter.
- Centralina elettronica termostatica inclusa (4 getti).
- Temperatura minima disponibile inferiore a 25°C.
- Sistema di messa a punto: Preparazione della temperatura desiderata.
- Con programma antilegionella.
- * NOTA: è obbligatorio aggiungere all'ordine un soffione, doccia a mano, bocchette o una canna per vasca da bagno, a seconda del tipo di installazione.





B-SYSTEM

The B-system collection of concealed thermostats is characterised by its elegant and minimalist design. The concealed inner box allows for a cleaner and simpler installation. B-system provides elegance and convenience for your shower.

La collezione di miscelatori termostatici a incasso B-system è caratterizzata da un design raffinato con linee sobrie. La scatola interna a incasso permette un'installazione più pulita e più semplice. B-system è eleganza e comfort nella doccia.





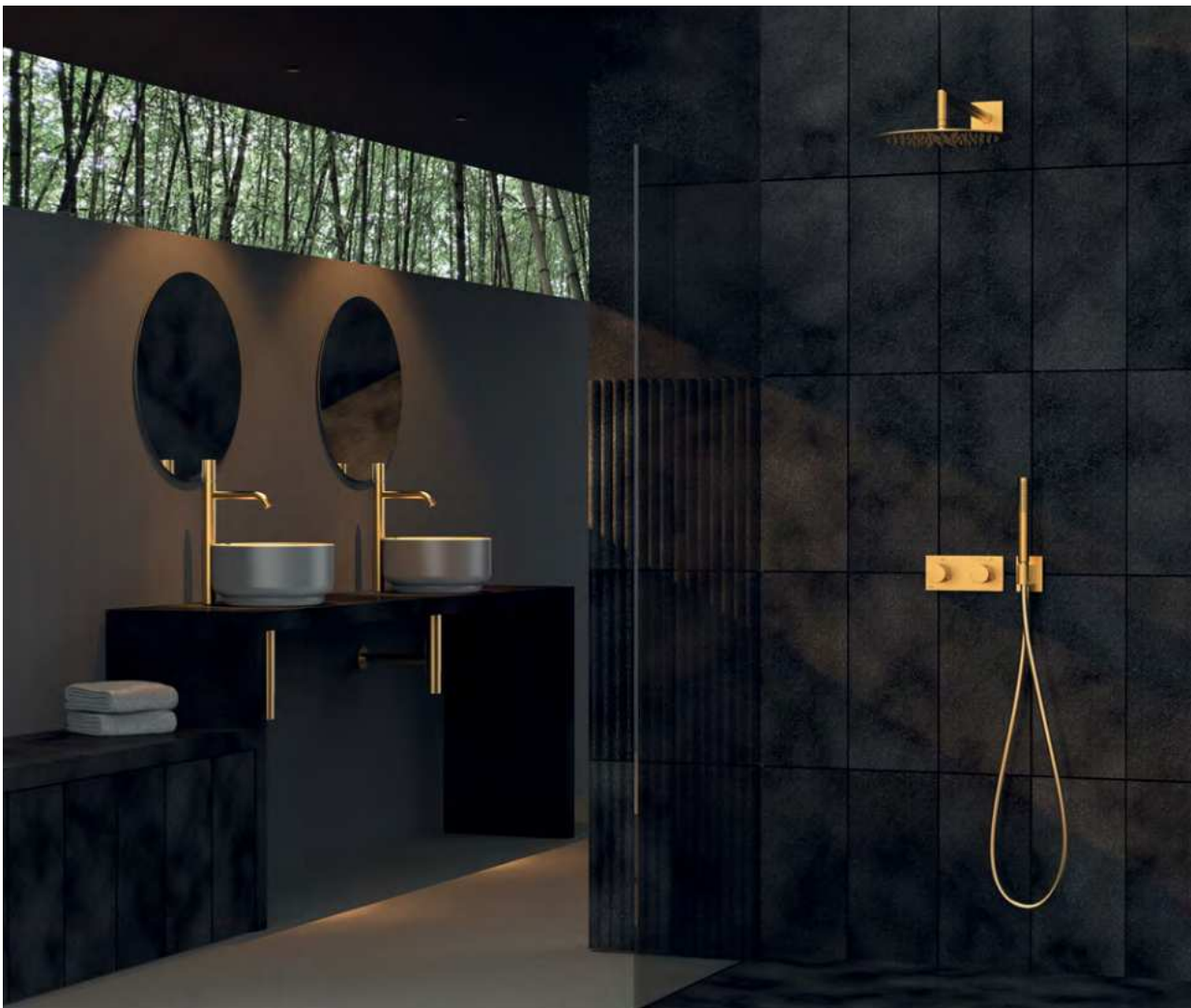

B-SYSTEM



The built-in box is included in every part seen (not supplied separately).
 La scatola da incasso è inclusa in ogni pezzo a vista (non è fornita separatamente).



The concealed box can **be installed in front of or behind the wall**, both in masonry and lightweight plasterboard walls (Pladur type).

La scatola incassata può essere **installata anteriormente o posteriormente alla parete**, sia nelle pareti in muratura che in quelle in cartongesso leggero (tipo Pladur).



You only need a **minimum depth of 66 mm** to install the recessed box.

Per l'installazione della cassetta a incasso sono sufficienti **66 mm di profondità minima**.



The visible parts are **not too long**, so you gain extra usable space inside the shower.

I pezzi mostrati hanno una **profondità ridotta**, permettendo di guadagnare più spazio utilizzabile all'interno della doccia.

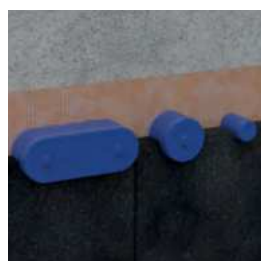

The concealed box insulates the brass body from heat transfer to the wall, and being **watertight**, prevents water from filtering through the wall in the event of a leak. The waterproof seal **prevents damp**.

La scatola incassata isola la trasmissione di temperatura del corpo in ottone verso la parete. Essendo **a tenuta stagna** impedisce all'acqua di penetrare attraverso la parete in caso di perdite. La giunzione impermeabile **previene l'umidità**.



Temperature control with a safety **push button** that limits the temperature to 38°C.
 Controllo della temperatura con **pulsante di sicurezza** che limita la temperatura a 38°C.

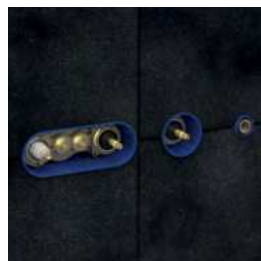

The **dampers** prevent noise transmission from the tap to the wall and piping.

Gli **ammortizzatori** impediscono la trasmissione del rumore del rubinetto alla parete e ai tubi.



From 2 to 4 water outlets. Change between the two different water outlets by just turning the distributor.

Da 2 a 4 uscite dell'acqua. Con una semplice rotazione del distributore è possibile passare da una all'altra uscita dell'acqua disponibili.



The cartridge ensures a **constant flow of water** at the desired temperature ± 1 degree, in spite of pressure and/or temperature changes. Designed for Legionella disinfection.

La cartuccia assicura una portata d'acqua costante alla temperatura desiderata di ± 1 grado in caso di variazioni di pressione e/o temperatura. Concepita per la **disinfezione dalla legionella**.

THERMOSTATIC CONCEALED TAPS / RUBINETTI TERMOSTATICI DA INCASSO

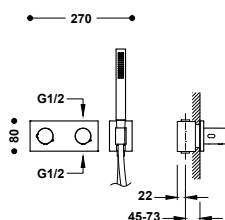

B-system 2-way concealed thermostatic mixer tap

- Concealed thermostatic body for horizontal installation included.
- Flow regulator and 2-way ceramic distributor.
- Round handle.
- Wall-mounted support for hand shower with water supply.
- Anti-limescale brass hand shower.
- Satin hose.

Miscelatore termostatico a incasso 2 getti B-system

- *Corpo termostatico a incasso con installazione orizzontale inclusa.*
- *Regolatore di flusso ed erogatore in ceramica a 2 getti.*
- *Manopola rotonda.*
- *Supporto per doccia con presa d'acqua a muro.*
- *Doccia mobile anticalcare in ottone.*
- *Flessibile satinato.*

	30735201	540,00
	30735201NM	837,00
	30735201AC	837,00
	30735201KMB	837,00
	30735201OR	1188,00
	30735201OM	1188,00
	30735201OP	1188,00
	30735201OPM	1188,00

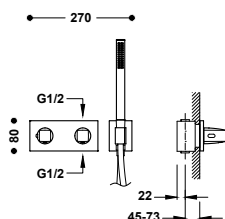
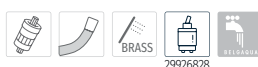

B-system 2-way concealed thermostatic mixer tap

- Concealed thermostatic body for horizontal installation included.
- Flow regulator and 2-way ceramic distributor.
- Square-round handle.
- Wall-mounted support for hand shower with water supply.
- Anti-limescale brass hand shower.
- Satin hose.

Miscelatore termostatico a incasso 2 getti B-system

- *Corpo termostatico a incasso con installazione orizzontale inclusa.*
- *Regolatore di flusso ed erogatore in ceramica a 2 getti.*
- *Manopola quadrata-rotonda.*
- *Supporto per doccia con presa d'acqua a muro.*
- *Doccia mobile anticalcare in ottone.*
- *Flessibile satinato.*

	30725201	560,00
	30725201NM	868,00
	30725201AC	868,00
	30725201KMB	868,00
	30725201OR	1.232,00
	30725201OM	1.232,00
	30725201OP	1.232,00
	30725201OPM	1.232,00

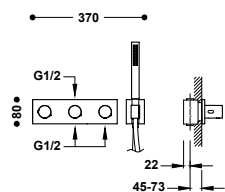
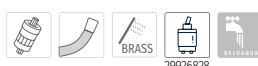

B-system 3-way concealed thermostatic mixer tap

- Concealed thermostatic body for horizontal installation included.
- Flow regulator and 3-way distributor.
- Round handle.
- Wall-mounted support for hand shower with water supply.
- Anti-limescale brass hand shower.
- Satin hose.

Miscelatore termostatico a incasso 3 getti B-system

- *Corpo termostatico a incasso con installazione orizzontale inclusa.*
- *Regolatore di flusso ed erogatore a 3 getti.*
- *Manopola rotonda.*
- *Supporto per doccia con presa d'acqua a muro.*
- *Doccia mobile anticalcare in ottone.*
- *Flessibile satinato.*

	30735301	640,00
	30735301NM	992,00
	30735301AC	992,00
	30735301KMB	992,00
	30735301OR	1.408,00
	30735301OM	1.408,00
	30735301OP	1.408,00
	30735301OPM	1.408,00

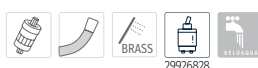

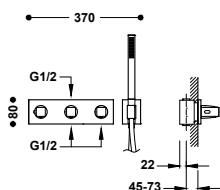

B-system 3-way concealed thermostatic mixer tap

- Concealed thermostatic body for horizontal installation included.
- Flow regulator and 3-way distributor.
- Square-round handle.
- Wall-mounted support for hand shower with water supply.
- Anti-limescale brass hand shower.
- Satin hose.

Miscelatore termostatico a incasso 3 getti B-system

- *Corpo termostatico a incasso con installazione orizzontale inclusa.*
- *Regolatore di flusso ed erogatore a 3 getti.*
- *Manopola quadrata-rotonda.*
- *Supporto per doccino con presa d'acqua a muro.*
- *Doccia mobile anticalcare in ottone.*
- *Flessibile satinato.*

30725301	660,00
30725301NM	1.023,00
30725301AC	1.023,00
30725301KMB	1.023,00 N
30725301OR	1.452,00
30725301OM	1.452,00
30725301OP	1.452,00
30725301OPM	1.452,00

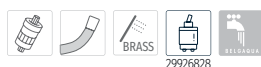

29926828

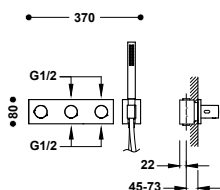

B-system 4-way concealed thermostatic mixer tap

- Concealed thermostatic body for horizontal installation included.
- Flow regulator and 4-way distributor.
- Round handle.
- Wall-mounted support for hand shower with water supply.
- Anti-limescale brass hand shower.
- Satin hose.

Miscelatore termostatico a incasso 4 getti B-system

- *Corpo termostatico a incasso con installazione orizzontale inclusa.*
- *Regolatore di flusso ed erogatore a 4 getti.*
- *Manopola rotonda.*
- *Supporto per doccino con presa d'acqua a muro.*
- *Doccia mobile anticalcare in ottone.*
- *Flessibile satinato.*

30735401	640,00
30735401NM	992,00
30735401AC	992,00
30735401KMB	992,00 N
30735401OR	1.408,00
30735401OM	1.408,00
30735401OP	1.408,00
30735401OPM	1.408,00

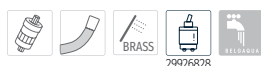

29926828

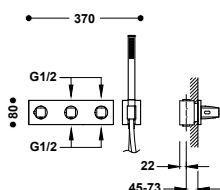

B-system 4-way concealed thermostatic mixer tap

- Concealed thermostatic body for horizontal installation included.
- Flow regulator and 4-way distributor.
- Square-round handle.
- Wall-mounted support for hand shower with water supply.
- Anti-limescale brass hand shower.
- Satin hose.

Miscelatore termostatico a incasso 4 getti B-system

- *Corpo termostatico a incasso con installazione orizzontale inclusa.*
- *Regolatore di flusso ed erogatore a 4 getti.*
- *Manopola quadrata-rotonda.*
- *Supporto per doccino con presa d'acqua a muro.*
- *Doccia mobile anticalcare in ottone.*
- *Flessibile satinato.*

30725401	660,00
30725401NM	1.023,00
30725401AC	1.023,00
30725401KMB	1.023,00 N
30725401OR	1.452,00
30725401OM	1.452,00
30725401OP	1.452,00
30725401OPM	1.452,00

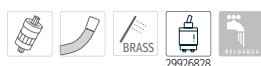

29926828

2-WAY KITS / KIT A 2 GETTI

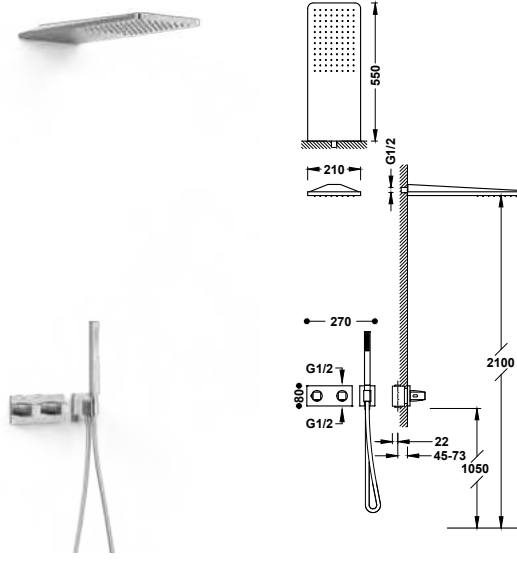

B-system 2-way concealed thermostatic shower mixer tap kit

- Concealed thermostatic body for horizontal installation included.
- Flow regulator and 2-way ceramic distributor.
- Square-round handle.
- Stainless steel wall-mounted shower head: 210x550 mm.
- Wall-mounted support for hand shower with water supply.
- Anti-limescale brass hand shower.
- Satin hose.

Kit di miscelatore termostatico a incasso 2 getti B-system per doccia

- Corpo termostatico a incasso con installazione orizzontale inclusa.
- Regolatore di flusso ed erogatore in ceramica a 2 getti.
- Manopola quadrata-rotonda.
- Soffione doccia a muro in acciaio inossidabile: 210x550 mm.
- Supporto per doccia con presa d'acqua a muro.
- Doccino anticalcare in ottone.
- Flessibile satinato.



30725205	1.116,00
30725205NM	1.730,00
30725205AC	1.730,00
30725205KMB	1.730,00
30725205OR	2.456,00
30725205OM	2.456,00
30725205OP	2.456,00
30725205OPM	2.456,00

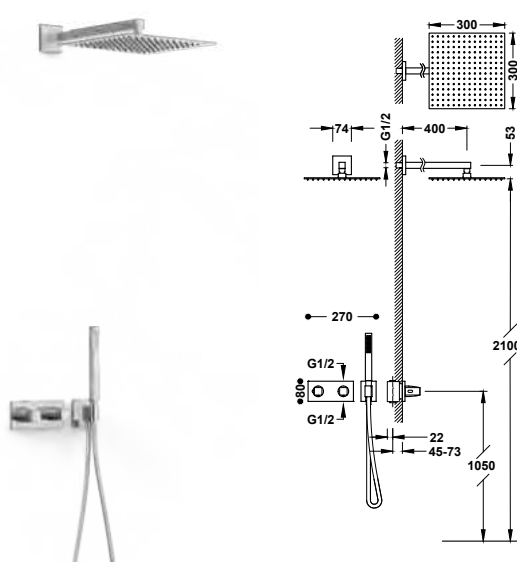

B-system 2-way concealed thermostatic shower mixer tap kit

- Concealed thermostatic body for horizontal installation included.
- Flow regulator and 2-way ceramic distributor.
- Square-round handle.
- Wall-mounted arm with adjustable brass shower head: 300x300 mm.
- Wall-mounted support for hand shower with water supply.
- Anti-limescale brass hand shower.
- Satin hose.

Kit di miscelatore termostatico a incasso 2 getti B-system per doccia

- Corpo termostatico a incasso con installazione orizzontale inclusa.
- Regolatore di flusso ed erogatore in ceramica a 2 getti.
- Manopola quadrata-rotonda.
- Braccio a muro con soffione doccia orientabile in acciaio inossidabile: 300x300 mm.
- Supporto per doccia con presa d'acqua a muro.
- Doccino anticalcare in ottone.
- Flessibile satinato.



30725204	782,00
30725204NM	1.210,00
30725204AC	1.210,00
30725204KMB	1.210,00
30725204OR	1.718,00
30725204OM	1.718,00
30725204OP	1.718,00
30725204OPM	1.718,00

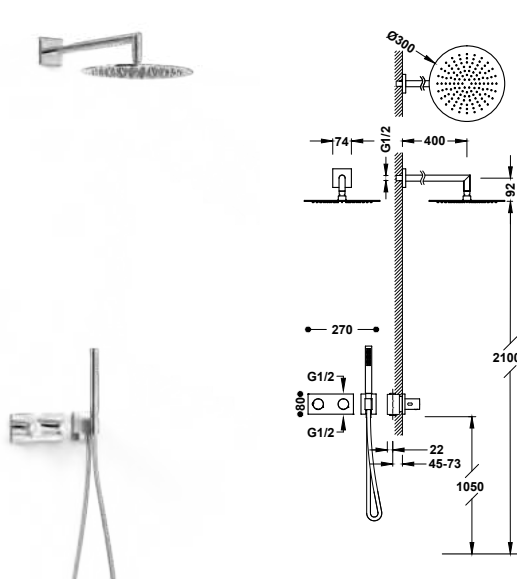

B-system 2-way concealed thermostatic shower mixer tap kit

- Concealed thermostatic body for horizontal installation included.
- Flow regulator and 2-way ceramic distributor.
- Round handle.
- Wall-mounted arm with adjustable stainless steel shower head: Ø 300 mm.
- Wall-mounted support for hand shower with water supply.
- Anti-limescale brass hand shower.
- Satin hose.

Kit di miscelatore termostatico a incasso 2 getti B-system per doccia

- Corpo termostatico a incasso con installazione orizzontale inclusa.
- Regolatore di flusso ed erogatore in ceramica a 2 getti.
- Manopola rotonda.
- Braccio a muro con soffione doccia orientabile in acciaio inossidabile: Ø 300 mm.
- Supporto per doccia con presa d'acqua a muro.
- Doccino anticalcare in ottone.
- Flessibile satinato.



30735204	811,00
30735204NM	1.163,00
30735204AC	1.163,00
30735204KMB	1.163,00
30735204OR	1.651,00
30735204OM	1.651,00
30735204OP	1.651,00
30735204OPM	1.651,00

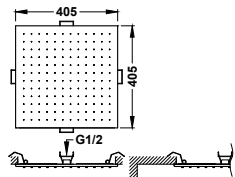

B-system 2-way concealed thermostatic shower mixer tap kit

- Concealed thermostatic body for horizontal installation included.
- Flow regulator and 2-way ceramic distributor.
- Square-round handle.
- Concealed stainless steel ceiling-mounted shower head: 405x405 mm.
- Wall-mounted support for hand shower with water supply.
- Anti-limescale brass hand shower.
- Satin hose.

Kit di miscelatore termostatico a incasso 2 getti B-system per doccia

- Corpo termostatico a incasso con installazione orizzontale inclusa.
- Regolatore di flusso ed erogatore in ceramica a 2 getti.
- Manopola quadrata-rotonda.
- Soffione doccia soffitto a incasso in acciaio inossidabile: 405x405 mm.
- Supporto per doccia con presa d'acqua a muro.
- Doccino anticalcare in ottone.
- Flessibile satinato.

	30725206	1.315,00
	30725206NM	1.855,00
	30725206AC	1.855,00
	30725206KMB	1.855,00 N
	30725206OR	2.895,00
	30725206OM	2.895,00
	30725206OP	2.895,00
	30725206OPM	2.895,00

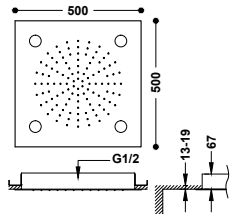
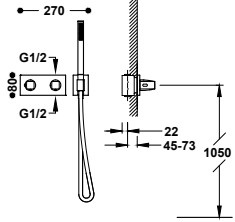

B-system 2-way concealed thermostatic shower mixer tap kit

- Concealed thermostatic body for horizontal installation included.
- Flow regulator and 2-way ceramic distributor.
- Square-round handle.
- Concealed stainless steel ceiling-mounted shower head with Chromotherapy: 500x500 mm.
- Wall-mounted support for hand shower with water supply.
- Anti-limescale brass hand shower.
- Satin hose.

Kit di miscelatore termostatico a incasso 2 getti B-system per doccia

- Corpo termostatico a incasso con installazione orizzontale inclusa.
- Regolatore di flusso ed erogatore in ceramica a 2 getti.
- Manopola quadrata-rotonda.
- Soffione doccia da soffitto a incasso con Cromoterapia in acciaio inossidabile: 500x500 mm.
- Supporto per doccia con presa d'acqua a muro.
- Doccino anticalcare in ottone.
- Flessibile satinato.

	30725208	1.852,00
--	----------	----------

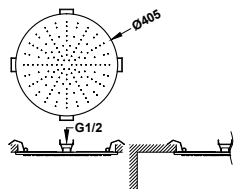
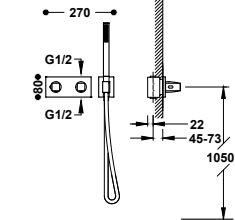

B-system 2-way concealed thermostatic shower mixer tap kit

- Concealed thermostatic body for horizontal installation included.
- Flow regulator and 2-way ceramic distributor.
- Round handle.
- Concealed stainless steel ceiling-mounted shower head: Ø 405 mm.
- Wall-mounted support for hand shower with water supply.
- Anti-limescale brass hand shower.
- Satin hose.

Kit di miscelatore termostatico a incasso 2 getti B-system per doccia

- Corpo termostatico a incasso con installazione orizzontale inclusa.
- Regolatore di flusso ed erogatore in ceramica a 2 getti.
- Manopola rotonda.
- Soffione doccia soffitto a incasso in acciaio inossidabile: Ø 405 mm.
- Supporto per doccia con presa d'acqua a muro.
- Doccino anticalcare in ottone.
- Flessibile satinato.

	30735206	1.329,00
	30735206NM	1.966,00
	30735206AC	1.966,00
	30735206KMB	1.966,00 N
	30735206OR	2.790,00
	30735206OM	2.790,00
	30735206OP	2.790,00
	30735206OPM	2.790,00

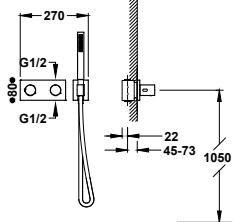

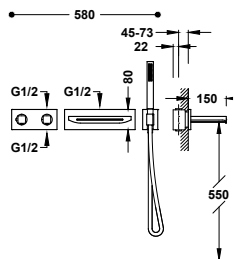

B-system 2-way concealed thermostatic mixer tap kit for bath and shower

- Concealed thermostatic body for horizontal installation included.
- Flow regulator and 2-way ceramic distributor.
- Square-round handle.
- Fixed wall-mounted spout with cascade outlet.
- Wall-mounted support for hand shower with water supply.
- Anti-limescale brass hand shower.
- Satin hose.

Kit di miscelatore termostatico a incasso 2 getti B-system per vasca e doccia

- Corpo termostatico a incasso con installazione orizzontale inclusa.
- Regolatore di flusso ed erogatore in ceramica a 2 getti.
- Manopola quadrata-rotonda.
- Canna fissa a muro con getto a cascata.
- Supporto per doccino con presa d'acqua a muro.
- Doccino anticalcare in ottone.
- Flessibile satinato.



30725207	1.197,00
30725207NM	1.855,00
30725207AC	1.855,00
30725207KMB	1.855,00
30725207OR	2.633,00
30725207OM	2.633,00
30725207OP	2.633,00
30725207OPM	2.633,00

3-WAY KITS / KIT A 3 GETTI

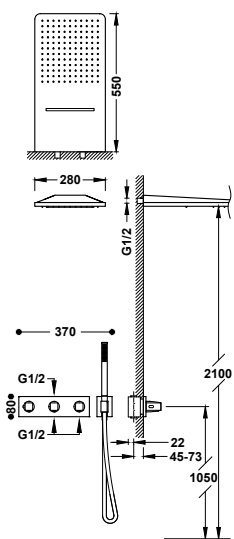

B-system 3-way concealed thermostatic shower mixer tap kit

- Concealed thermostatic body for horizontal installation included.
- Flow regulator and 3-way distributor.
- Square-round handle.
- Stainless steel wall-mounted shower head with 2 stream types (rain/cascade). 280x550 mm. IMPORTANT: Install a >50 l/min drain.
- Wall-mounted support for hand shower with water supply.
- Anti-limescale brass hand shower.
- Satin hose.

Kit di miscelatore termostatico a incasso 3 getti B-system per doccia

- Corpo termostatico a incasso con installazione orizzontale inclusa.
- Regolatore di flusso ed erogatore a 3 getti.
- Manopola quadrata-rotonda.
- Soffione doccia a muro in acciaio inossidabile con 2 tipi di getto (pioggia/cascata). 280x550 mm. IMPORTANTE: Montare uno scarico da >50 l/min.
- Supporto per doccino con presa d'acqua a muro.
- Doccino anticalcare in ottone.
- Flessibile satinato.



30725305	1.410,00
30725305NM	2.172,00
30725305AC	2.172,00
30725305KMB	2.172,00
30725305OR	3.083,00
30725305OM	3.083,00
30725305OP	3.083,00
30725305OPM	3.083,00

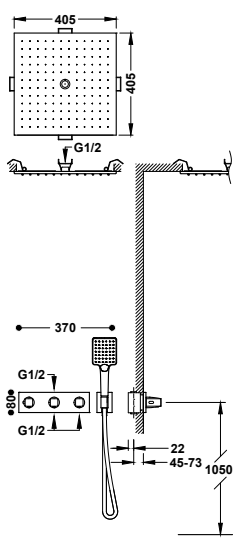

B-system 3-way concealed thermostatic shower mixer tap kit

- Concealed thermostatic body for horizontal installation included.
- Flow regulator and 3-way distributor.
- Square-round handle.
- Stainless steel concealed ceiling-mounted shower head with 2 stream types (rain/free flow). 405x405 mm.
- Wall-mounted support for hand shower with water supply.
- Anti-limescale hand showers: 96x110 mm. (3 stream types).
- Satin hose.

Kit di miscelatore termostatico a incasso 3 getti B-system per doccia

- Corpo termostatico a incasso con installazione orizzontale inclusa.
- Regolatore di flusso ed erogatore a 3 getti.
- Manopola quadrata-rotonda.
- Soffione doccia a incasso da soffitto in acciaio inossidabile con 2 tipi di getto (pioggia/free flow). 405x405 mm.
- Supporto per doccino con presa d'acqua a muro.
- Doccino anticalcare: 96x110 mm. (3 tipi di getto).
- Flessibile satinato.



30725306	1.477,00
30725306NM	2.290,00
30725306AC	2.290,00
30725306KMB	2.290,00
30725306OR	3.250,00
30725306OM	3.250,00
30725306OP	3.250,00
30725306OPM	3.250,00

4-WAY KITS / KIT A 4 GETTI

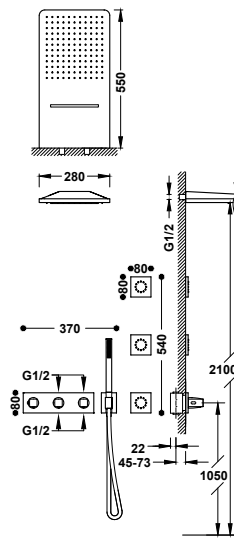

B-system 4-way concealed thermostatic shower mixer tap kit

- Concealed thermostatic body for horizontal installation included.
- Flow regulator and 4-way distributor.
- Square-round handle.
- Stainless steel wall-mounted shower head with 2 stream types (rain/cascade). 280x550 mm. IMPORTANT: Install a >50 l/min drain.
- 3 concealed hydromassage jets.
- Wall-mounted support for hand shower with water supply.
- Anti-limescale brass hand shower.
- Satin hose.

30725405	1.842,00
30725405NM	2.854,00
30725405AC	2.854,00
30725405KMB	2.854,00 N
30725405OR	4.051,00
30725405OM	4.051,00
30725405OP	4.051,00
30725405OPM	4.051,00

**Kit di miscelatore termostatico a incasso 4 getti
B-system per doccia**

- Corpo termostatico a incasso con installazione orizzontale inclusa.
- Regolatore di flusso ed erogatore a 4 getti.
- Manopola quadrata-rotonda.
- Soffione doccia a muro in acciaio inossidabile con 2 tipi di getto (pioggia/cascata). 280x550 mm. IMPORTANTE: Montare uno scarico da >50 l/min.
- 3 getti idromassaggio a incasso.
- Supporto per doccino con presa d'acqua a muro.
- Doccino anticalcare in ottone.
- Flessibile satinato.



29926828

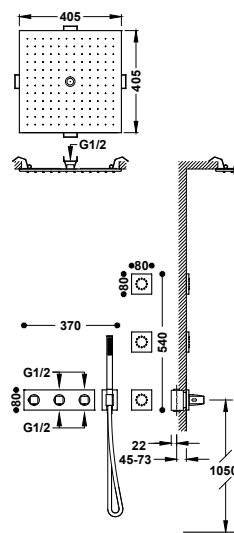

B-system 4-way concealed thermostatic shower mixer tap kit

- Concealed thermostatic body for horizontal installation included.
- Flow regulator and 4-way distributor.
- Square-round handle.
- Stainless steel concealed ceiling-mounted shower head with 2 stream types (rain/free flow). 405x405 mm.
- 3 concealed hydromassage jets.
- Wall-mounted support for hand shower with water supply.
- Anti-limescale brass hand shower.
- Satin hose.

30725406	1.918,00
30725406NM	2.972,00
30725406AC	2.972,00
30725406KMB	2.972,00 N
30725406OR	4.219,00
30725406OM	4.219,00
30725406OP	4.219,00
30725406OPM	4.219,00

**Kit di miscelatore termostatico a incasso 4 getti
B-system per doccia**

- Corpo termostatico a incasso con installazione orizzontale inclusa.
- Regolatore di flusso ed erogatore a 4 getti.
- Manopola quadrata-rotonda.
- Soffione doccia a incasso da soffitto in acciaio inossidabile con 2 tipi di getto (pioggia/free flow). 405x405 mm.
- 3 getti idromassaggio a incasso.
- Supporto per doccino con presa d'acqua a muro.
- Doccino anticalcare in ottone.
- Flessibile satinato.



29926828



THERM-BOX

Therm-box is the concealed system from Tres for thermostatic shower taps. Total temperature control with a compact design. You can purchase the concealed box and the visible part separately, making it easier to plan your project and saving you time.

Therm-box è il sistema da incasso di Tres per i rubinetti doccia termostatici. Controllo totale della temperatura in un design compatto. La scatola da incasso e la parte a vista sono acquistabili separatamente, in questo modo la pianificazione del lavoro risulta semplificata ed efficiente.

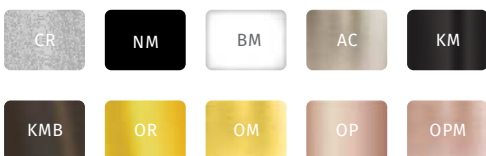





THERM-BOX

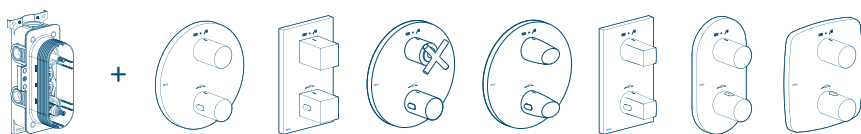

Buy separately

You can install the Therm-box first before buying the visible part once everything is ready. This helps you simplify your project and save time.

Acquista separatamente

Puoi installare la Therm-box e, successivamente, acquistare la parte a vista per installarla quando tutto è pronto. In questo modo la pianificazione del lavoro risulta semplificata ed efficiente.



The visible parts are **not too long**, so you gain extra usable space inside the shower.

*I pezzi mostrati hanno una **profondità ridotta**, permettendo di guadagnare più spazio utilizzabile all'interno della doccia.*



The Therm-box can be installed in **front of or behind the wall**, both in masonry and lightweight plasterboard walls (Pladur type).

*La scatola incassata Therm-box può essere **installata anteriormente o posteriormente alla parete**, sia nelle pareti in muratura che in quelle in cartongesso leggero (tipo Pladur).*

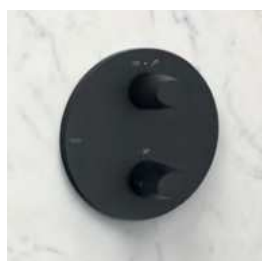

The visible parts are available in **various finishes** and designs that can be combined with the Tres collections.

*I pezzi mostrati sono disponibili in **varie finiture** e modelli da abbinare alle collezioni Tres.*



You only need a **minimum depth of 66 mm** to install the recessed box.

*Per l'installazione della cassetta a incasso sono sufficienti **66 mm di profondità minima**.*



Temperature control with a **safety push button** that limits the temperature to 38°C.

*Controllo della temperatura con **pulsante di sicurezza** che limita la temperatura a 38°C.*



The concealed box insulates the brass body from heat transfer to the wall, and being **watertight**, prevents water from filtering through the wall in the event of a leak. The waterproof seal **prevents damp**.

*La scatola incassata isola la trasmissione di temperatura del corpo in ottone verso la parete. Essendo **a tenuta stagna** impedisce all'acqua di penetrare attraverso la parete in caso di perdite. La giunzione impermeabile **previene l'umidità**.*



Change between the **two different water outlets** by just turning the distributor.

*Con una semplice rotazione del distributore è possibile passare tra le **2 prese d'acqua disponibili**.*



The **dampers** prevent noise transmission from the tap to the wall and piping.

*Gli **ammortizzatori** impediscono la trasmissione del rumore del rubinetto alla parete e ai tubi.*

CONCEALED BOX / SCATOLA DA INCASSO

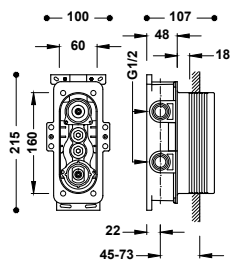

Therm-box 2-way concealed box with thermostatic tap for shower and bathtub

20785001 130,00

Concealed body with acoustic buffers. ABS embedding box. Anti-moisture seal. 2-way ceramic distributor.

Scatola da incasso a 2 getti Therm-box con miscelatore termostatico per doccia e vasca da bagno

Corpo incassato con smorzatori acustici. Scatola da incasso in ABS. Guarnizione antiumidità. Erogatore in ceramica a 2 getti.



2-WAY VISIBLE PARTS / ELEMENTI A VISTA A 2 GETTI

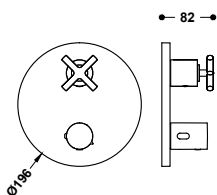

Visible part for concealed 2-way Therm-box

- 28325001 179,00
- 28325001NM 277,00
- 28325001AC 277,00
- 28325001OM 393,00
- 28325001OPM 393,00

Only visible part. Crossed handle. Includes trim plate, control and distribution handle. Complete with concealed Therm-box ref.: 20785001.

Pezzo vista per cassa da incasso a 2 vie Therm-box

Solo parte vista. Manopola a croce. Include piastra decorativa, comando e volante distributore. Completare con scatola da incasso Therm-box rif.: 20785001.

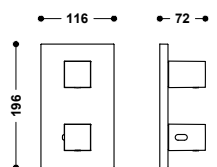

Visible part for concealed 2-way Therm-box

- 00625001 137,00
- 00625001NM 212,00
- 00625001BM 212,00
- 00625001AC 212,00
- 00625001OR 300,00
- 00625001OM 300,00

Only visible part. Square handle. Includes trim plate, control and distribution handle. Complete with concealed Therm-box ref.: 20785001.

Pezzo vista per cassa da incasso a 2 vie Therm-box

Solo parte vista. Manopola quadrata. Include piastra decorativa, comando e volante distributore. Completare con scatola da incasso Therm-box rif.: 20785001.

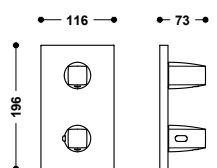

Visible part for concealed 2-way Therm-box

- 21125001 116,00
- 21125001NM 179,00
- 21125001BM 179,00
- 21125001AC 179,00
- 21125001KM 179,00
- 21125001KMB 179,00
- 21125001OR 254,00
- 21125001OM 254,00
- 21125001OP 254,00
- 21125001OPM 254,00

Only visible part. Square-round handle. Includes trim plate, control and distribution handle. Complete with concealed Therm-box ref.: 20785001.

Pezzo vista per cassa da incasso a 2 vie Therm-box

Solo parte vista. Manopola quadrata-rotonda. Include piastra decorativa, comando e volante distributore. Completare con scatola da incasso Therm-box rif.: 20785001.

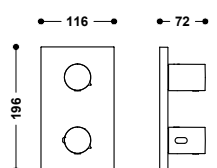

Visible part for concealed 2-way Therm-box

06225001 116,00

Only visible part. Round handle. Includes trim plate, control and distribution handle. Complete with concealed Therm-box ref.: 20785001.

Pezzo vista per cassa da incasso a 2 vie Therm-box

Solo parte vista. Manopola rotonda. Include piastra decorativa, comando e volante distributore. Completare con scatola da incasso Therm-box rif.: 20785001.

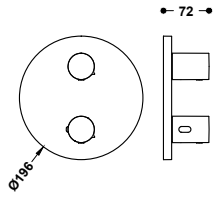

Visible part for concealed 2-way Therm-box

Only visible part. Round handle. Includes trim plate, control and distribution handle. Complete with concealed Therm-box ref.: 20785001.

Pezzo vista per cassa da incasso a 2 vie Therm-box

Solo parte vista. Manopola rotonda. Include piastra decorativa, comando e volante distributore. Completare con scatola da incasso Therm-box rif.: 20785001.

26225001	137,00
26225001NM	212,00
26225001BM	212,00
26225001AC	212,00
26225001KM	212,00
26225001KMB	212,00
26225001OR	300,00
26225001OM	300,00
26225001OP	300,00
26225001OPM	300,00

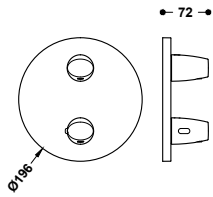

Visible part for concealed 2-way Therm-box

Only visible part. Oval handle. Includes trim plate, control and distribution handle. Complete with concealed Therm-box ref.: 20785001.

Pezzo vista per cassa da incasso a 2 vie Therm-box

Solo parte vista. Manopola ovale. Include piastra decorativa, comando e volante distributore. Completare con scatola da incasso Therm-box rif.: 20785001.

28125001	116,00
28125001NM	179,00
28125001AC	179,00
28125001OPM	254,00

2-WAY THERMOSTATIC KITS / KIT TERMOSTATICI A 2 GETTI

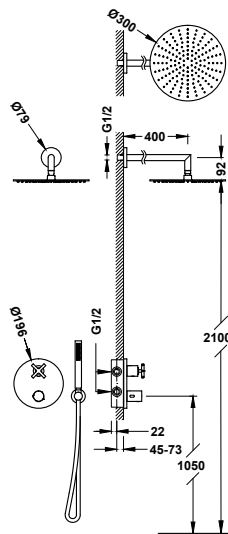

Therm-box 2-way concealed thermostatic tap kit for showers

- Concealed body included.
- Crossed handle with temperature control. 2-way ceramic distributor.
- Wall-mounted arm with adjustable stainless steel shower head: Ø 300 mm.
- Wall-mounted support for hand shower with water supply.
- Anti-limescale brass hand shower.
- Satin hose.

Kit di miscelatore termostatico da incasso a 2 getti Therm-box per doccia

- Corpo a incasso incluso.
- Manopola a croce con controllo della temperatura. Erogatore in ceramica a 2 getti.
- Braccio a muro con soffione doccia orientabile in acciaio inossidabile: Ø 300 mm.
- Supporto per doccia con presa d'acqua a muro.
- Doccino anticalcare in ottone.
- Flessibile satinato.

28325002	625,00
28325002NM	899,00
28325002AC	899,00
28325002OM	1.224,00
28325002OPM	1.224,00



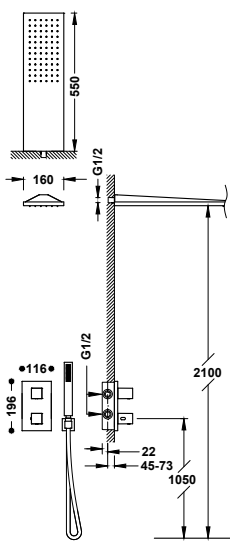

Therm-box 2-way concealed thermostatic tap kit for showers

- Concealed body included.
- Square handle with temperature control. 2-way ceramic distributor.
- Stainless steel wall-mounted shower head: 160x550 mm.
- Wall-mounted support for hand shower with water supply.
- Anti-limescale brass hand shower.
- Satin hose.

**Kit di miscelatore termostatico da incasso a 2 getti
Therm-box per doccia**

- Corpo a incasso incluso.
- Manopola quadrata con controllo della temperatura. Erogatore in ceramica a 2 getti.
- Soffione doccia a muro in acciaio inossidabile: 160x550 mm.
- Supporto per doccia con presa d'acqua a muro.
- Doccino anticalcare in ottone.
- Flessibile satinato.



■ 20225055	829,00
■ 20225055NM	1.216,00
■ 20225055BM	1.216,00
■ 20225055AC	1.216,00
■ 20225055KMB	1.216,00
■ 20225055OR	1.672,00
■ 20225055OM	1.672,00

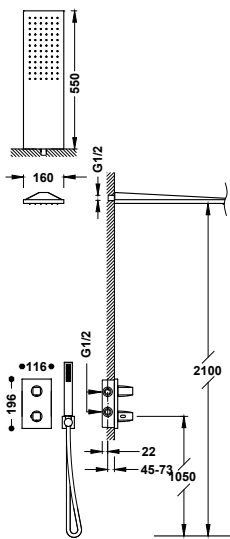

Therm-box 2-way concealed thermostatic tap kit for showers

- Concealed body included.
- Square-round handle with temperature control. 2-way ceramic distributor.
- Stainless steel wall-mounted shower head: 160x550 mm.
- Wall-mounted support for hand shower with water supply.
- Anti-limescale brass hand shower.
- Satin hose.

**Kit di miscelatore termostatico da incasso a 2 getti
Therm-box per doccia**

- Corpo a incasso incluso.
- Manopola quadrata-rotonda con controllo della temperatura. Erogatore in ceramica a 2 getti.
- Soffione doccia a muro in acciaio inossidabile: 160x550 mm.
- Supporto per doccia con presa d'acqua a muro.
- Doccino anticalcare in ottone.
- Flessibile satinato.



■ 21125005	785,00
■ 21125005NM	1.147,00
■ 21125005BM	1.147,00
■ 21125005AC	1.147,00
■ 21125005KM	1.147,00
■ 21125005KMB	1.147,00
■ 21125005OR	1.575,00
■ 21125005OM	1.575,00
■ 21125005OP	1.575,00
■ 21125005OPM	1.575,00

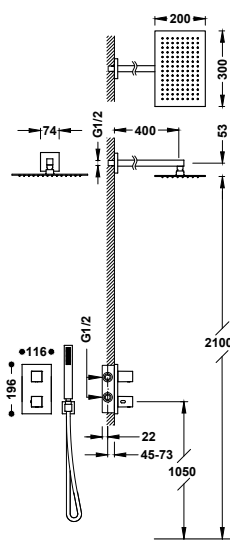

Therm-box 2-way concealed thermostatic tap kit for showers

- Concealed body included.
- Square handle with temperature control. 2-way ceramic distributor.
- Wall-mounted arm with adjustable stainless steel shower head: 300x200 mm.
- Wall-mounted support for hand shower with water supply.
- Anti-limescale brass hand shower.
- Satin hose.

**Kit di miscelatore termostatico da incasso a 2 getti
Therm-box per doccia**

- Corpo a incasso incluso.
- Manopola quadrata con controllo della temperatura. Erogatore in ceramica a 2 getti.
- Braccio a muro con soffione doccia orientabile in acciaio inossidabile: 300x200 mm.
- Supporto per doccia con presa d'acqua a muro.
- Doccino anticalcare in ottone.
- Flessibile satinato.



■ 20225054	677,00
■ 20225054NM	975,00
■ 20225054BM	975,00
■ 20225054AC	975,00
■ 20225054OR	1.331,00
■ 20225054OM	1.331,00

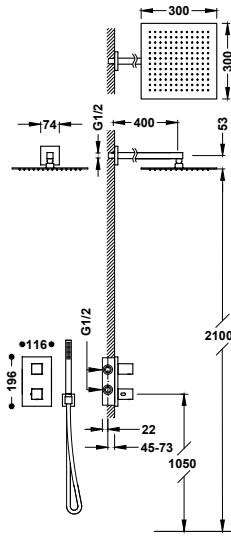

Therm-box 2-way concealed thermostatic tap kit for showers

- Concealed body included.
- Square handle with temperature control. 2-way ceramic distributor.
- Wall-mounted arm with adjustable stainless steel shower head: 300x300 mm.
- Wall-mounted support for hand shower with water supply.
- Anti-limescale brass hand shower.
- Satin hose.

**Kit di miscelatore termostatico da incasso a 2 getti
Therm-box per doccia**

- Corpo a incasso incluso.
- Manopola quadrata con controllo della temperatura. Erogatore in ceramica a 2 getti.
- Braccio a muro con soffione doccia orientabile in acciaio inossidabile: 300x300 mm.
- Supporto per doccia con presa d'acqua a muro.
- Doccino anticalcare in ottone.
- Flessibile satinato.

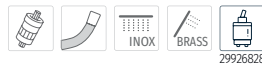

00625004	641,00
00625004NM	922,00
00625004BM	922,00
00625004AC	922,00
00625004OR	1.256,00
00625004OM	1.256,00

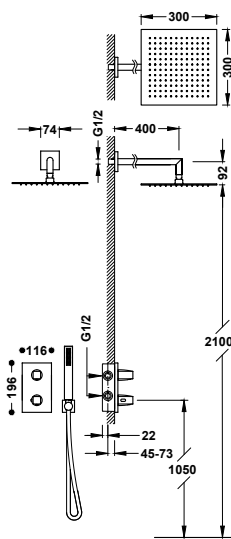

Therm-box 2-way concealed thermostatic tap kit for showers

- Concealed body included.
- Square-round handle with temperature control. 2-way ceramic distributor.
- Wall-mounted arm with adjustable stainless steel shower head: 300x300 mm.
- Wall-mounted support for hand shower with water supply.
- Anti-limescale brass hand shower.
- Satin hose.

**Kit di miscelatore termostatico da incasso a 2 getti
Therm-box per doccia**

- Corpo a incasso incluso.
- Manopola quadrata-rotonda con controllo della temperatura. Erogatore in ceramica a 2 getti.
- Braccio a muro con soffione doccia orientabile in acciaio inossidabile: 300x300 mm.
- Supporto per doccia con presa d'acqua a muro.
- Doccino anticalcare in ottone.
- Flessibile satinato.



21125004	595,00
21125004NM	849,00
21125004BM	849,00
21125004AC	849,00
21125004KM	849,00
21125004KMB	849,00
21125004OR	1.153,00
21125004OM	1.153,00
21125004OP	1.153,00
21125004OPM	1.153,00

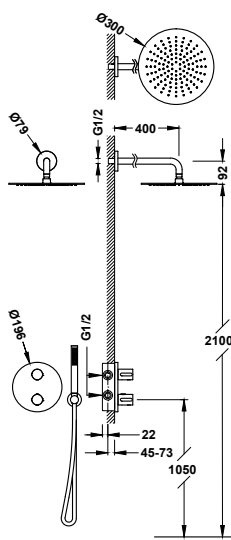

Therm-box 2-way concealed thermostatic tap kit for showers

- Concealed body included.
- Round handle with temperature control. 2-way ceramic distributor.
- Wall-mounted arm with adjustable stainless steel shower head: Ø 300 mm.
- Wall-mounted support for hand shower with water supply.
- Anti-limescale brass hand shower.
- Satin hose.

**Kit di miscelatore termostatico da incasso a 2 getti
Therm-box per doccia**

- Corpo a incasso incluso.
- Manopola rotonda con controllo della temperatura. Erogatore in ceramica a 2 getti.
- Braccio a muro con soffione doccia orientabile in acciaio inossidabile: Ø 300 mm.
- Supporto per doccia con presa d'acqua a muro.
- Doccino anticalcare in ottone.
- Flessibile satinato.



26225004	585,00
26225004NM	837,00
26225004BM	837,00
26225004AC	837,00
26225004KM	837,00
26225004KMB	837,00
26225004OR	1.136,00
26225004OM	1.136,00
26225004OP	1.136,00
26225004OPM	1.136,00

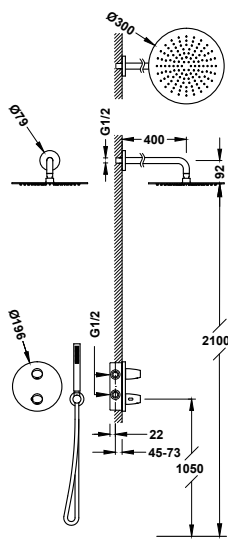

Therm-box 2-way concealed thermostatic tap kit for showers

- Concealed body included.
- Oval handle with temperature control. 2-way ceramic distributor.
- Wall-mounted arm with adjustable stainless steel shower head: \varnothing 300 mm.
- Wall-mounted support for hand shower with water supply.
- Anti-limescale brass hand shower.
- Satin hose.

Kit di miscelatore termostatico da incasso a 2 getti Therm-box per doccia

- Corpo a incasso incluso.
- Manopola ovale con controllo della temperatura. Erogatore in ceramica a 2 getti.
- Braccio a muro con soffione doccia orientabile in acciaio inossidabile: \varnothing 300 mm.
- Supporto per doccia con presa d'acqua a muro.
- Doccino anticalcare in ottone.
- Flessibile satinato.



28125004	566,00
28125004NM	806,00
28125004AC	806,00
28125004OPM	1.092,00

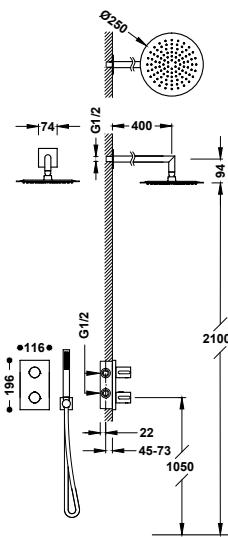

Therm-box 2-way concealed thermostatic tap kit for showers

- Concealed body included.
- Round handle with temperature control. 2-way ceramic distributor.
- Wall-mounted arm with adjustable stainless steel shower head: \varnothing 250 mm.
- Wall-mounted support for hand shower with water supply.
- Anti-limescale brass hand shower.
- Satin hose.

Kit di miscelatore termostatico da incasso a 2 getti Therm-box per doccia

- Corpo a incasso incluso.
- Manopola rotonda con controllo della temperatura. Erogatore in ceramica a 2 getti.
- Braccio a muro con soffione doccia orientabile in acciaio inossidabile: \varnothing 250 mm.
- Supporto per doccia con presa d'acqua a muro.
- Doccino anticalcare in ottone.
- Flessibile satinato.



06225004	515,00
----------	--------

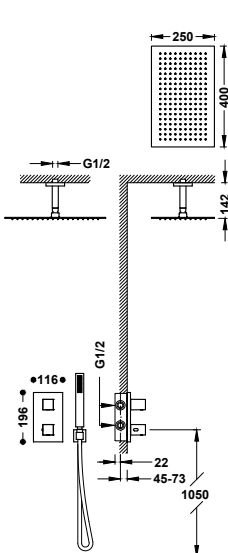

Therm-box 2-way concealed thermostatic tap kit for showers

- Concealed body included.
- Square handle with temperature control. 2-way ceramic distributor.
- Ceiling-mounted arm with adjustable stainless steel shower head: 400x250 mm.
- Wall-mounted support for hand shower with water supply.
- Anti-limescale brass hand shower.
- Satin hose.

Kit di miscelatore termostatico da incasso a 2 getti Therm-box per doccia

- Corpo a incasso incluso.
- Manopola quadrata con controllo della temperatura. Erogatore in ceramica a 2 getti.
- Braccio a soffitto con soffione doccia orientabile in acciaio inossidabile: 400x250 mm.
- Supporto per doccia con presa d'acqua a muro.
- Doccino anticalcare in ottone.
- Flessibile satinato.



20225053	705,00
20225053NM	1.023,00
20225053BM	1.023,00
20225053AC	1.023,00
20225053KMB	1.023,00
20225053OR	1.399,00
20225053OM	1.399,00

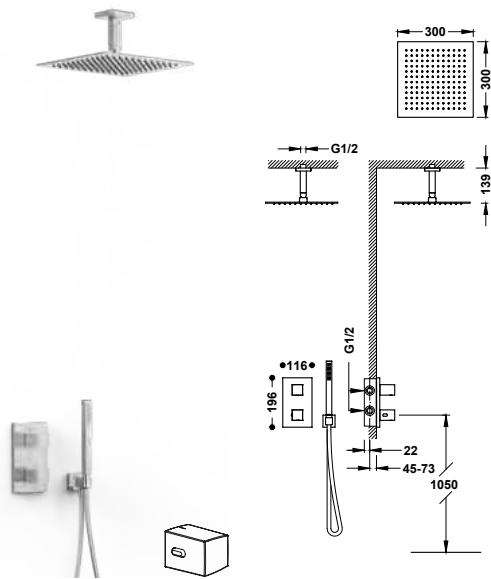

Therm-box 2-way concealed thermostatic tap kit for showers

- Concealed body included.
- Square handle with temperature control. 2-way ceramic distributor.
- Ceiling-mounted arm with adjustable stainless steel shower head: 300x300 mm.
- Wall-mounted support for hand shower with water supply.
- Anti-limescale brass hand shower.
- Satin hose.

**Kit di miscelatore termostatico da incasso a 2 getti
Therm-box per doccia**

- Corpo a incasso incluso.
- Manopola quadrata con controllo della temperatura. Erogatore in ceramica a 2 getti.
- Braccio a soffitto con soffione doccia orientabile in acciaio inossidabile: 300x300 mm.
- Supporto per doccia con presa d'acqua a muro.
- Doccino anticalcare in ottone.
- Flessibile satinato.



00625003	620,00
00625003NM	888,00
00625003BM	888,00
00625003AC	888,00
00625003OR	1.207,00
00625003OM	1.207,00

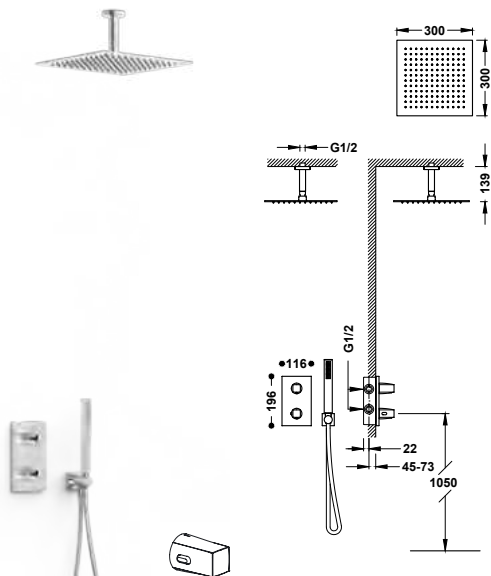

Therm-box 2-way concealed thermostatic tap kit for showers

- Concealed body included.
- Square-round handle with temperature control. 2-way ceramic distributor.
- Ceiling-mounted arm with adjustable stainless steel shower head: 300x300 mm.
- Wall-mounted support for hand shower with water supply.
- Anti-limescale brass hand shower.
- Satin hose.

**Kit di miscelatore termostatico da incasso a 2 getti
Therm-box per doccia**

- Corpo a incasso incluso.
- Manopola quadrata-rotonda con controllo della temperatura. Erogatore in ceramica a 2 getti.
- Braccio a soffitto con soffione doccia orientabile in acciaio inossidabile: 300x300 mm.
- Supporto per doccia con presa d'acqua a muro.
- Doccino anticalcare in ottone.
- Flessibile satinato.



21125003	566,00
21125003NM	805,00
21125003BM	805,00
21125003AC	805,00
21125003KM	805,00
21125003KMB	805,00
21125003OR	1.089,00
21125003OM	1.089,00
21125003OP	1.089,00
21125003OPM	1.089,00

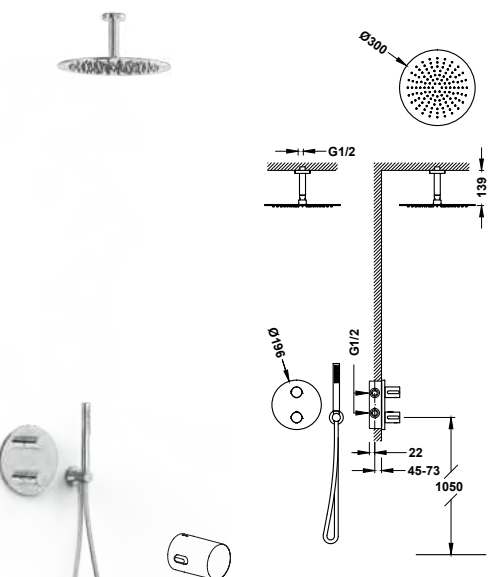

Therm-box 2-way concealed thermostatic tap kit for showers

- Concealed body included.
- Round handle with temperature control. 2-way ceramic distributor.
- Ceiling-mounted arm with adjustable stainless steel shower head: Ø 300 mm.
- Wall-mounted support for hand shower with water supply.
- Anti-limescale brass hand shower.
- Satin hose.

**Kit di miscelatore termostatico da incasso a 2 getti
Therm-box per doccia**

- Corpo a incasso incluso.
- Manopola rotonda con controllo della temperatura. Erogatore in ceramica a 2 getti.
- Braccio a soffitto con soffione doccia orientabile in acciaio inossidabile: Ø 300 mm.
- Supporto per doccia con presa d'acqua a muro.
- Doccino anticalcare in ottone.
- Flessibile satinato.



26225003	558,00
26225003NM	797,00
26225003BM	797,00
26225003AC	797,00
26225003KM	797,00
26225003KMB	797,00
26225003OR	1.078,00
26225003OM	1.078,00
26225003OP	1.078,00
26225003OPM	1.078,00

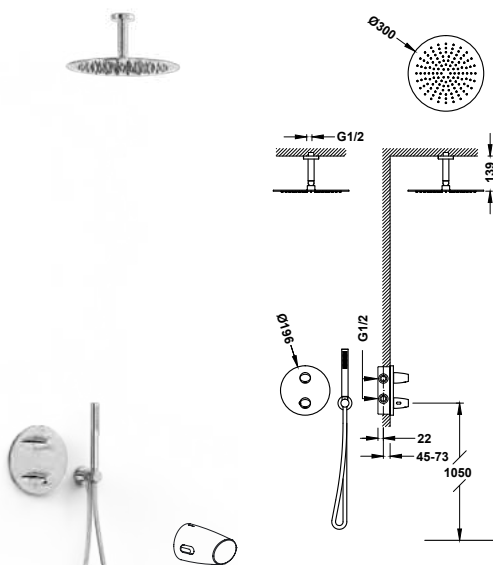

Therm-box 2-way concealed thermostatic tap kit for showers

- Concealed body included.
- Oval handle with temperature control. 2-way ceramic distributor.
- Ceiling-mounted arm with adjustable stainless steel shower head: Ø 300 mm.
- Wall-mounted support for hand shower with water supply.
- Anti-limescale brass hand shower.
- Satin hose.

28125003	538,00
28125003NM	766,00
28125003AC	766,00

Kit di miscelatore termostatico da incasso a 2 getti Therm-box per doccia

- Corpo a incasso incluso.
- Manopola ovale con controllo della temperatura. Erogatore in ceramica a 2 getti.
- Braccio a soffitto con soffione doccia orientabile in acciaio inossidabile: Ø 300 mm.
- Supporto per doccia con presa d'acqua a muro.
- Doccino anticalcare in ottone.
- Flessibile satinato.

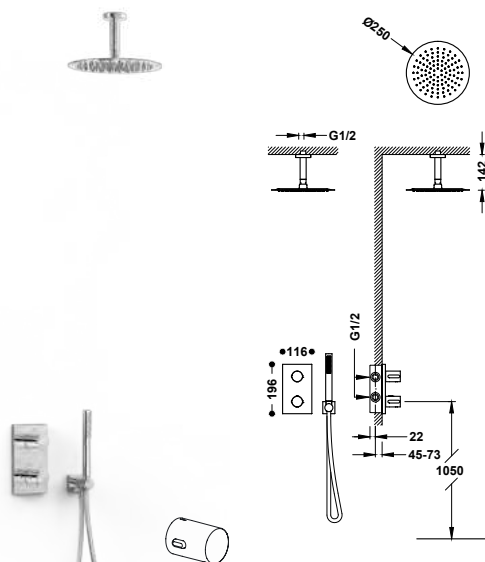

Therm-box 2-way concealed thermostatic tap kit for showers

- Concealed body included.
- Round handle with temperature control. 2-way ceramic distributor.
- Ceiling-mounted arm with adjustable stainless steel shower head: Ø 250 mm.
- Wall-mounted support for hand shower with water supply.
- Anti-limescale brass hand shower.
- Satin hose.

06225003	480,00
----------	--------

Kit di miscelatore termostatico da incasso a 2 getti Therm-box per doccia

- Corpo a incasso incluso.
- Manopola rotonda con controllo della temperatura. Erogatore in ceramica a 2 getti.
- Braccio a soffitto con soffione doccia orientabile in acciaio inossidabile: Ø 250 mm.
- Supporto per doccia con presa d'acqua a muro.
- Doccino anticalcare in ottone.
- Flessibile satinato.

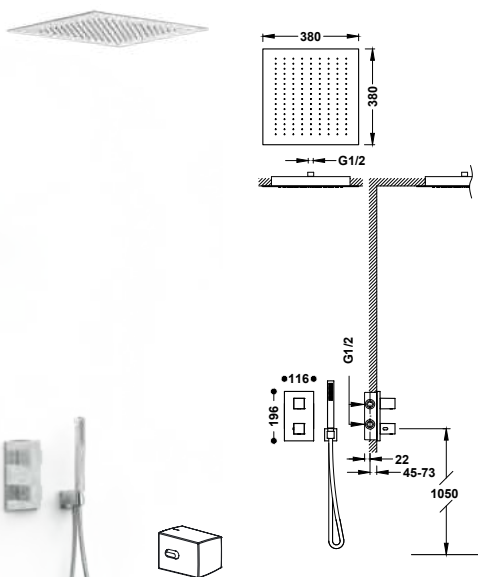

Therm-box 2-way concealed thermostatic tap kit for showers

- Concealed body included.
- Square handle with temperature control. 2-way ceramic distributor.
- Concealed stainless steel ceiling-mounted shower head: 380x380 mm.
- Wall-mounted support for hand shower with water supply.
- Anti-limescale brass hand shower.
- Satin hose.

00625005	1.180,00
00625005NM	1.761,00
00625005BM	1.761,00
00625005AC	1.761,00
00625005OR	2.447,00
00625005OM	2.447,00

Kit di miscelatore termostatico da incasso a 2 getti Therm-box per doccia

- Corpo a incasso incluso.
- Manopola quadrata con controllo della temperatura. Erogatore in ceramica a 2 getti.
- Soffione doccia soffitto a incasso in acciaio inossidabile: 380x380 mm.
- Supporto per doccia con presa d'acqua a muro.
- Doccino anticalcare in ottone.
- Flessibile satinato.



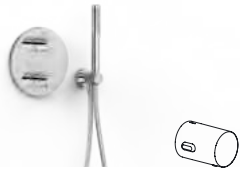
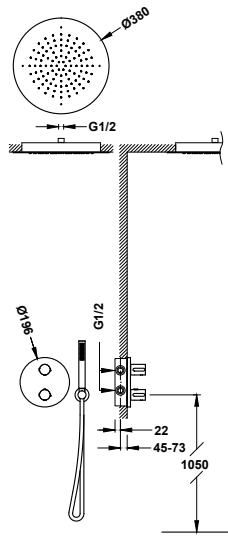

Therm-box 2-way concealed thermostatic tap kit for showers

- Concealed body included.
- Round handle with temperature control. 2-way ceramic distributor.
- Concealed stainless steel ceiling-mounted shower head: Ø 380 mm.
- Wall-mounted support for hand shower with water supply.
- Anti-limescale brass hand shower.
- Satin hose.

**Kit di miscelatore termostatico da incasso a 2 getti
Therm-box per doccia**

- Corpo a incasso incluso.
- Manopola rotonda con controllo della temperatura. Erogatore in ceramica a 2 getti.
- Soffione doccia soffitto a incasso in acciaio inossidabile: Ø 380 mm.
- Supporto per doccia con presa d'acqua a muro.
- Doccino anticalcare in ottone.
- Flessibile satinato.



26225005	1.164,00
26225005NM	1.737,00
26225005BM	1.737,00
26225005AC	1.737,00
26225005KM	1.737,00
26225005KMB	1.737,00
26225005OR	2.412,00
26225005OM	2.412,00
26225005OP	2.412,00
26225005OPM	2.412,00

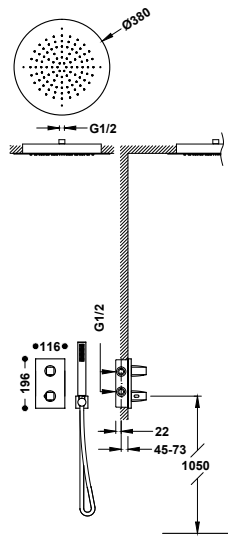

Therm-box 2-way concealed thermostatic tap kit for showers

- Concealed body included.
- Square-round handle with temperature control. 2-way ceramic distributor.
- Concealed stainless steel ceiling-mounted shower head: Ø 380 mm.
- Wall-mounted support for hand shower with water supply.
- Anti-limescale brass hand shower.
- Satin hose.

**Kit di miscelatore termostatico da incasso a 2 getti
Therm-box per doccia**

- Corpo a incasso incluso.
- Manopola quadrata-rotonda con controllo della temperatura. Erogatore in ceramica a 2 getti.
- Soffione doccia soffitto a incasso in acciaio inossidabile: Ø 380 mm.
- Supporto per doccia con presa d'acqua a muro.
- Doccino anticalcare in ottone.
- Flessibile satinato.



21125006	1.140,00
21125006NM	1.696,00
21125006BM	1.696,00
21125006AC	1.696,00
21125006KM	1.696,00
21125006KMB	1.696,00
21125006OR	2.355,00
21125006OM	2.355,00
21125006OP	2.355,00
21125006OPM	2.355,00

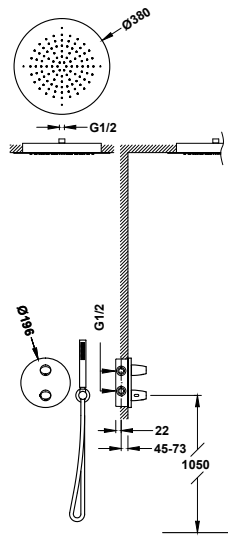

Therm-box 2-way concealed thermostatic tap kit for showers

- Concealed body included.
- Oval handle with temperature control. 2-way ceramic distributor.
- Concealed stainless steel ceiling-mounted shower head: Ø 380 mm.
- Wall-mounted support for hand shower with water supply.
- Anti-limescale brass hand shower.
- Satin hose.

**Kit di miscelatore termostatico da incasso a 2 getti
Therm-box per doccia**

- Corpo a incasso incluso.
- Manopola ovale con controllo della temperatura. Erogatore in ceramica a 2 getti.
- Soffione doccia soffitto a incasso in acciaio inossidabile: Ø 380 mm.
- Supporto per doccia con presa d'acqua a muro.
- Doccino anticalcare in ottone.
- Flessibile satinato.



28125005	1.145,00
28125005NM	1.706,00
28125005AC	1.706,00
28125005OPM	2.369,00

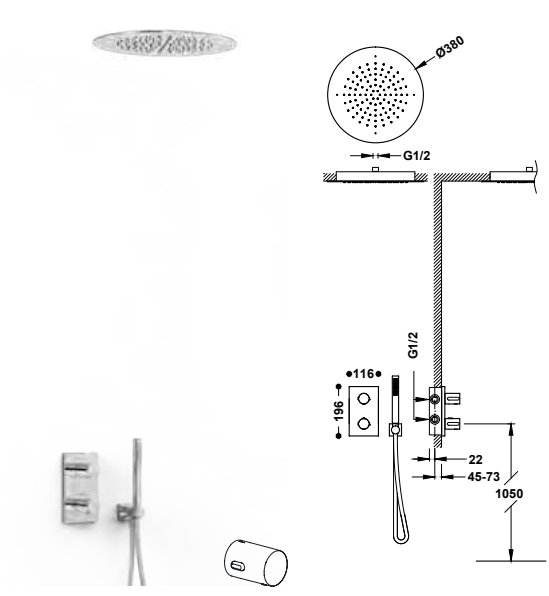

Therm-box 2-way concealed thermostatic tap kit for showers

06225005 1.131,00

- Concealed body included.
- Round handle with temperature control. 2-way ceramic distributor.
- Concealed stainless steel ceiling-mounted shower head: Ø 380 mm.
- Wall-mounted support for hand shower with water supply.
- Anti-limescale brass hand shower.
- Satin hose.

Kit di miscelatore termostatico da incasso a 2 getti Therm-box per doccia

- Corpo a incasso incluso.
- Manopola rotonda con controllo della temperatura. Erogatore in ceramica a 2 getti.
- Soffione da soffitto a incasso in acciaio inossidabile: Ø 380 mm.
- Supporto per doccia con presa d'acqua a muro.
- Doccino anticalcare in ottone.
- Flessibile satinato.

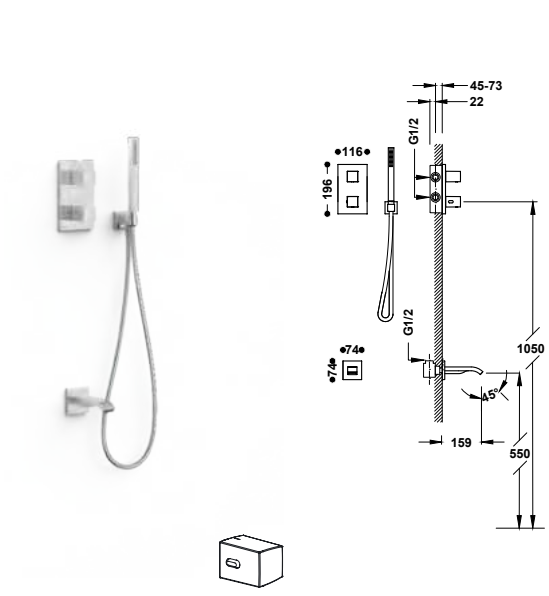

Therm-box 2-way concealed thermostatic tap kit for baths and showers

00625006 542,00
 00625006NM 769,00
 00625006BM 769,00
 00625006AC 769,00
 00625006OR 1.039,00
 00625006OM 1.039,00

- Concealed body included.
- Square handle with temperature control. 2-way ceramic distributor.
- Fixed wall-mounted spout.
- Wall-mounted support for hand shower with water supply.
- Anti-limescale brass hand shower.
- Satin hose.

Kit di miscelatore termostatico da incasso a 2 getti Therm-box per vasca da bagno e doccia

- Corpo a incasso incluso.
- Manopola quadrata con controllo della temperatura. Erogatore in ceramica a 2 getti.
- Canna fissa a muro.
- Supporto per doccia con presa d'acqua a muro.
- Doccino anticalcare in ottone.
- Flessibile satinato.

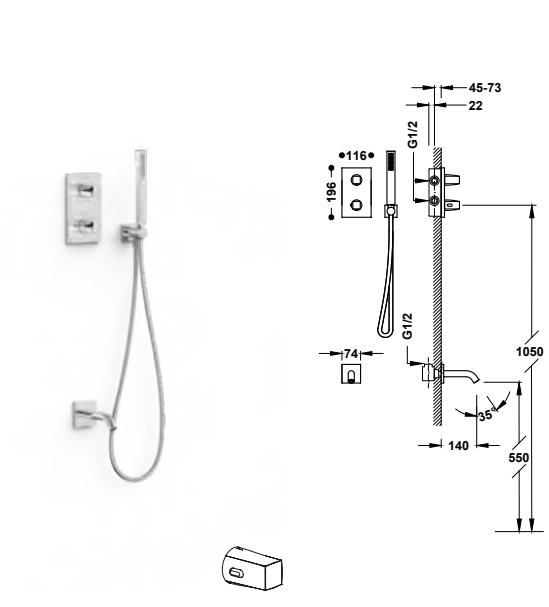

Therm-box 2-way concealed thermostatic tap kit for baths and showers

21125007 445,00
 21125007NM 621,00
 21125007BM 621,00
 21125007AC 621,00
 21125007KM 621,00
 21125007KMB 621,00
 21125007OR 828,00
 21125007OM 828,00
 21125007OP 828,00
 21125007OPM 828,00

- Concealed body included.
- Square-round handle with temperature control. 2-way ceramic distributor.
- Fixed wall-mounted spout.
- Wall-mounted support for hand shower with water supply.
- Anti-limescale brass hand shower.
- Satin hose.

Kit di miscelatore termostatico da incasso a 2 getti Therm-box per vasca da bagno e doccia

- Corpo a incasso incluso.
- Manopola quadrata-rotonda con controllo della temperatura. Erogatore in ceramica a 2 getti.
- Canna fissa a muro.
- Supporto per doccia con presa d'acqua a muro.
- Doccino anticalcare in ottone.
- Flessibile satinato.



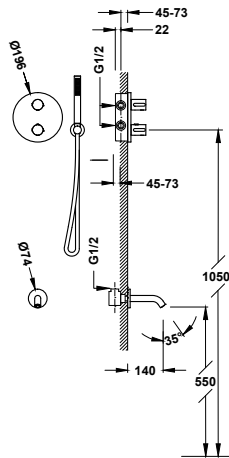

Therm-box 2-way concealed thermostatic tap kit for baths and showers

- Concealed body included.
- Round handle with temperature control. 2-way ceramic distributor.
- Fixed wall-mounted spout.
- Wall-mounted support for hand shower with water supply.
- Anti-limescale brass hand shower.
- Satin hose.

**Kit di miscelatore termostatico da incasso a 2 getti
Therm-box per vasca da bagno e doccia**

- Corpo a incasso incluso.
- Manopola rotonda con controllo della temperatura. Erogatore in ceramica a 2 getti.
- Canna fissa a muro.
- Supporto per doccia con presa d'acqua a muro.
- Doccino anticalcare in ottone.
- Flessibile satinato.



26225006	470,00
26225006NM	650,00
26225006BM	650,00
26225006AC	650,00
26225006KM	650,00
26225006KMB	650,00
26225006OR	850,00
26225006OM	850,00
26225006OP	850,00
26225006OPM	850,00

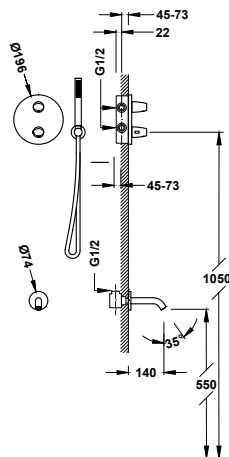

Therm-box 2-way concealed thermostatic tap kit for baths and showers

- Concealed body included.
- Oval handle with temperature control. 2-way ceramic distributor.
- Fixed wall-mounted spout.
- Wall-mounted support for hand shower with water supply.
- Anti-limescale brass hand shower.
- Satin hose.

**Kit di miscelatore termostatico da incasso a 2 getti
Therm-box per vasca da bagno e doccia**

- Corpo a incasso incluso.
- Manopola ovale con controllo della temperatura. Erogatore in ceramica a 2 getti.
- Canna fissa a muro.
- Supporto per doccia con presa d'acqua a muro.
- Doccino anticalcare in ottone.
- Flessibile satinato.



28125006	450,00
28125006NM	633,00
28125006AC	633,00

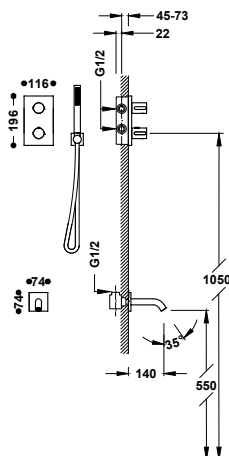

Therm-box 2-way concealed thermostatic tap kit for baths and showers

- Concealed body included.
- Round handle with temperature control. 2-way ceramic distributor.
- Fixed wall-mounted spout.
- Wall-mounted support for hand shower with water supply.
- Anti-limescale brass hand shower.
- Satin hose.

**Kit di miscelatore termostatico da incasso a 2 getti
Therm-box per vasca da bagno e doccia**

- Corpo a incasso incluso.
- Manopola rotonda con controllo della temperatura. Erogatore in ceramica a 2 getti.
- Canna fissa a muro.
- Supporto per doccia con presa d'acqua a muro.
- Doccino anticalcare in ottone.
- Flessibile satinato.



06225006	436,00
----------	--------



OVER-WALL

The Over-wall thermostatic collection includes all the surface-mounted thermostatic taps from Tres. With various different designs that can be adapted to all spaces, offering total temperature control and everything you need to enjoy a pleasant shower. The Over-wall thermostatic sets are the perfect solution to update your shower without major building work and with the best technology.

La collezione termostatica Over-wall riunisce tutti i rubinetti termostatici da appoggio di Tres. Con diversi modelli per adattarsi a tutti gli ambienti, offrono un controllo totale della temperatura e tutte le caratteristiche per una doccia piacevole. I gruppi doccia termostatici Over-wall sono la soluzione per aggiornare la tua doccia senza grandi ristrutturazioni e con la migliore tecnologia.

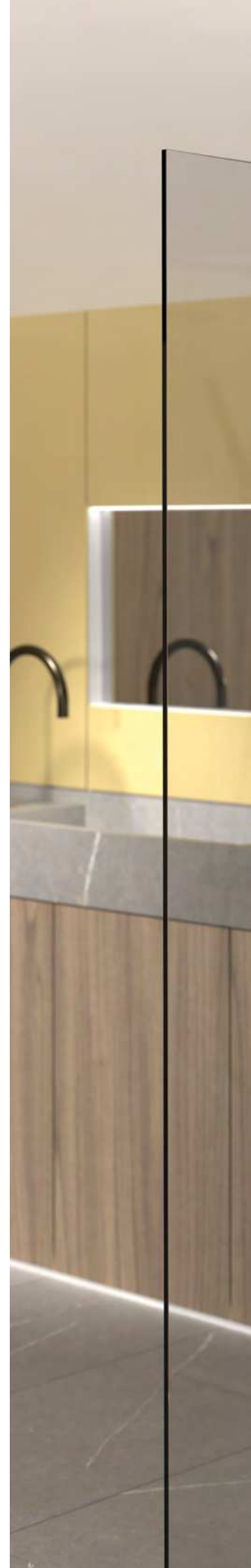
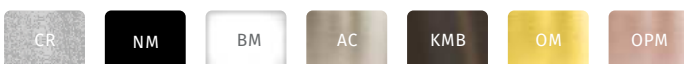





OVER-WALL



Square
Quadrata

Square-round
Quadrata-rotonda

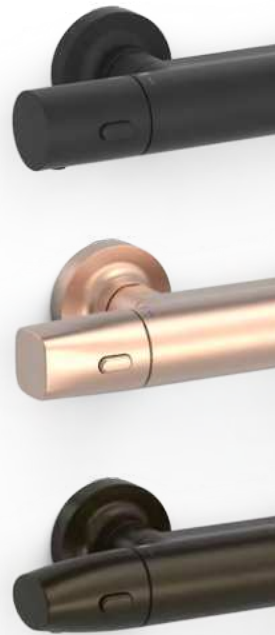

Round
Rotonda

Rounded edges
Bordi arrotondati

Oval
Ovale



Temperature control with a **safety push button** that limits the temperature to 38°C.
*Controllo della temperatura con **pulsante di sicurezza** che limita la temperatura a 38°C.*



Touch-cool

The internal water circuit makes the cold water come in contact with the surface, meaning **the tap stays cool when touched and preventing burns.**

*Il circuito interno dell'acqua fa in modo che sia l'acqua fredda a toccare la superficie e in questo modo **il rubinetto rimane sempre freddo al tatto, evitando bruciate.***



Inverter built into the flow rate regulator control for 2 and 3 outlets.

***Deviatore integrato** nella manopola è presente un regolatore di flusso, sia per 2 che per 3 vie.*



Easy-clean

Tres offers the possibility of **cleaning the cartridge easily** in the event of blockage, without losing its calibration.

*Tres offre la possibilità di **pulire facilmente la cartuccia** in caso di ingorgo senza perderne la calibratura.*



Telescopic bar, allowing the shower head height to be adjusted to suit each need.





































***Barra telescopica** che consente di definire l'altezza del soffione, secondo le necessità.*



















































Instant 77











































The cartridge ensures a **constant flow of water** at the desired temperature ± 1 degree, in spite of pressure and/or temperature changes. Designed for Legionella disinfection.







































*La cartuccia assicura una **portata d'acqua costante** alla temperatura desiderata di ± 1 grado in caso di variazioni di pressione e/o temperatura. Concepita per la disinfezione dalla legionella.*

Reference Riferimento	Page Pagina	Available finishes Finiture disponibili	Handle designs Design manopole	Touch-cool	Telescopic bar Colonna telescopica	Flexible hoses Flessibili	Shower head Soffione	Dimensions Dimensioni	Water flow (l/min) Flusso (l/min)	Hand showers Doccino	Dimensions Dimensioni	Number of functions Numero di funzioni	Water flow (l/min) Flusso (l/min)
 19039306	→302					 1,5 m	 INOX	300 x 200	12	 BRASS		1	9,5
 19039308	→302					 1,5 m	 INOX	300 x 300	12	 BRASS		1	9,5
 19039310	→302					 1,5 m	 INOX	250 x 250	12	 BRASS		1	9,5
 19039309	→303					 1,5 m	 INOX	300 x 300	12	 ABS	96 x 110	3	882
 19039305	→303					 1,5 m	 INOX	300 x 300	12	 BRASS		1	9,5
 19038702	→303					 1,5 m	 INOX	300 x 300	12	 ABS	96 x 110	3	88 2

Reference Riferimento	Page Pagina	Available finishes Finiture disponibili	Handle designs Design manopole	Touch-cool	Telescopic bar Colonna telescopica	Flexible hoses Flessibili	Shower head Soffione	Dimensions Dimensioni	Water flow (l/min) Flusso (l/min)	Hand showers Doccino	Dimensions Dimensioni	Number of functions Numero di funzioni	Water flow (l/min) Flusso (l/min)
 19039307	→304					 1,5 m	 INOX	300 x 300	12	 BRASS		1	9.5
 19038706	→304					 1,5 m	 INOX	250 x 250	12	 ABS	96 x 110	3	882
 19038705	→304					 1,5 m	 INOX	300	12	 ABS	100	3	882
 19039302	→305					 1,5 m	 INOX	300	12	 BRASS		1	9.5
 19039311	→305					 1,5 m	 INOX	250 x 250	12	 ABS	96 x 110	3	882
 19038709	→305					 1,5 m	 INOX	250 x 250	12	 BRASS		1	9.5



	Reference Riferimento	Page Pagina	Available finishes Finiture disponibili	Handle designs Design manopole	Touch-cool	Telescopic bar Colonna telescopica	Flexible hoses Flessibili	Shower head Soffione	Dimensions Dimensioni	Water flow (l/min) Flusso (l/min)	Hand showers Doccino	Dimensions Dimensioni	Number of functions Numero di funzioni	Water flow (l/min) Flusso (l/min)
	19039314	→306							300	12		100	3	882
	19038708	→306							Ø 250	12			1	9.5
	19039313	→306							250 x 250	12		96 x 110	3	882
	19039312	→307							Ø 250	12			1	9.5
	19039318	→307							220 x 220	12			1	13
	19038707	→307							242 x 242	12		120 x 120	3	10149

Reference Riferimento	Page Pagina	Available finishes Finiture disponibili	Handle designs Design manopole	Touch-cool	Telescopic bar Colonna telescopica	Flexible hoses Flessibili	Shower head Soffione	Dimensions Dimensioni	Water flow (l/min) Flusso (l/min)	Hand showers Doccino	Dimensions Dimensioni	Number of functions Numero di funzioni	Water flow (l/min) Flusso (l/min)
 19039315	→308					 1,5 m		Ø 225	12		Ø 110	5	1717111710
 19031215	→308					 1,7 m		300 x 300	12			1	9.5
 19031205	→308					 1,7 m		300 x 300	12			1	9.5
 19031212	→309					 1,7 m		300	12			1	9.5
 19031202	→309					 1,7 m		Ø 300	12			1	9.5



THERMOSTATIC SETS FOR SHOWER / SET TERMOSTATICI PER DOCCIA

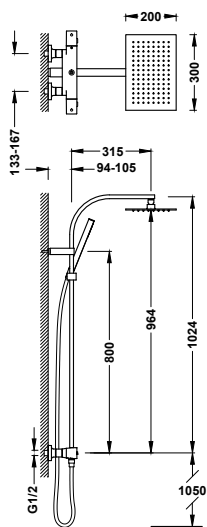

2-way Over-wall thermostatic shower mixer tap set

- With diverter integrated into the flow regulator.
- Square handle.
- Stainless steel adjustable shower head: 300x200 mm.
- Adjustable and sliding support for hand shower.
- Anti-limescale brass hand shower.
- Satin hose.

Set di miscelatore termostatico a muro Over-wall 2 getti per doccia

- Con inverter incorporato nel regolatore di flusso.
- Manopola quadrata.
- Soffione doccia orientabile in acciaio inossidabile: 300x200 mm.
- Supporto scorrevole e orientabile per doccia.
- Doccino anticalcare in ottone.
- Flessibile satinato.

19039306	671,00
19039306NM	1.040,00
19039306BM	1.040,00
19039306AC	1.040,00
19039306KMB	1.040,00
19039306OM	1.476,00



29916836XX

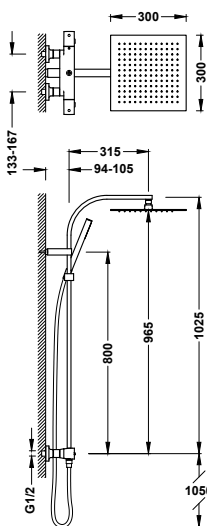

2-way Over-wall thermostatic shower mixer tap set

- With diverter integrated into the flow regulator.
- Square handle.
- Stainless steel adjustable shower head: 300x300 mm.
- Adjustable and sliding support for hand shower.
- Anti-limescale brass hand shower.
- Satin hose.

Set di miscelatore termostatico a muro Over-wall 2 getti per doccia

- Con inverter incorporato nel regolatore di flusso.
- Manopola quadrata.
- Soffione doccia orientabile in acciaio inossidabile: 300x300 mm.
- Supporto scorrevole e orientabile per doccia.
- Doccino anticalcare in ottone.
- Flessibile satinato.

19039308	620,00
19039308NM	961,00
19039308BM	961,00
19039308AC	961,00
19039308OM	1.364,00



29916836XX

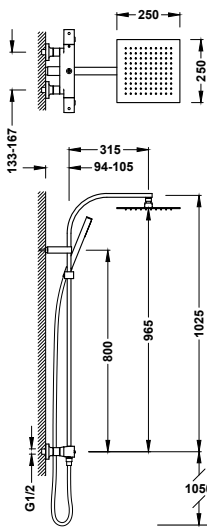

2-way Over-wall thermostatic shower mixer tap set

- With diverter integrated into the flow regulator.
- Square handle.
- Stainless steel adjustable shower head: 250x250 mm.
- Adjustable and sliding support for hand shower.
- Anti-limescale brass hand shower.
- Satin hose.

Set di miscelatore termostatico a muro Over-wall 2 getti per doccia

- Con inverter incorporato nel regolatore di flusso.
- Manopola quadrata.
- Soffione doccia orientabile in acciaio inossidabile: 250x250 mm.
- Supporto scorrevole e orientabile per doccia.
- Doccino anticalcare in ottone.
- Flessibile satinato.

19039310	590,00
----------	--------



29916836

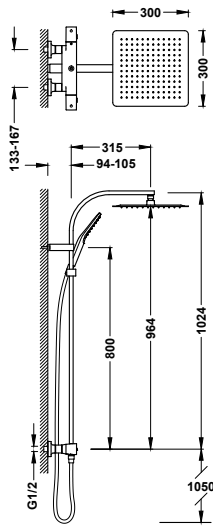

2-way Over-wall thermostatic shower mixer tap set

19039309 587,00

- With diverter integrated into the flow regulator.
- Square handle.
- Stainless steel adjustable shower head: 300x300 mm.
- Adjustable and sliding support for hand shower.
- Anti-limescale hand showers: 96x110 mm. (3 stream types).
- Satin hose.

Set di miscelatore termostatico a muro Over-wall 2 getti per doccia

- Con inverter incorporato nel regolatore di flusso.
- Manopola quadrata.
- Soffione doccia orientabile in acciaio inossidabile: 300x300 mm.
- Supporto scorrevole e orientabile per doccia.
- Doccino anticalcare: 96x110 mm. (3 tipi di getto).
- Flessibile satinato.

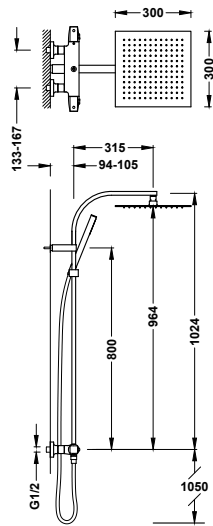

2-way Over-wall thermostatic shower mixer tap set

19039305	625,00
19039305NM	969,00
19039305BM	969,00
19039305AC	969,00
19039305KMB	969,00
19039305OM	1.375,00
19039305OPM	1.375,00

- With diverter integrated into the flow regulator.
- Square-round handle.
- Stainless steel adjustable shower head: 300x300 mm.
- Adjustable and sliding support for hand shower.
- Anti-limescale brass hand shower.
- Satin hose.

Set di miscelatore termostatico a muro Over-wall 2 getti per doccia

- Con inverter incorporato nel regolatore di flusso.
- Manopola quadrata-rotonda.
- Soffione doccia orientabile in acciaio inossidabile: 300x300 mm.
- Supporto scorrevole e orientabile per doccia.
- Doccino anticalcare in ottone.
- Flessibile satinato.

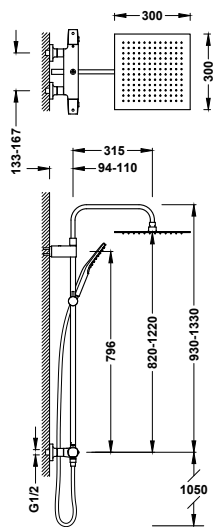

2-way Over-wall thermostatic shower mixer tap set

19038702	609,00
19038702NM	944,00
19038702BM	944,00
19038702AC	944,00
19038702KMB	944,00
19038702OM	1.340,00
19038702OPM	1.340,00

- With diverter integrated into the flow regulator.
- Handle with rounded edges.
- Telescopic shower bar.
- Stainless steel adjustable shower head: 300x300 mm.
- Adjustable and sliding support for hand shower.
- Anti-limescale hand showers: 96x110 mm. (3 stream types).
- Satin hose.

Set di miscelatore termostatico a muro Over-wall 2 getti per doccia

- Con inverter incorporato nel regolatore di flusso.
- Manopola con bordi arrotondati.
- Colonna doccia telescopica.
- Soffione doccia orientabile in acciaio inossidabile: 300x300 mm.
- Supporto scorrevole e orientabile per doccia.
- Doccino anticalcare: 96x110 mm. (3 tipi di getto).
- Flessibile satinato.



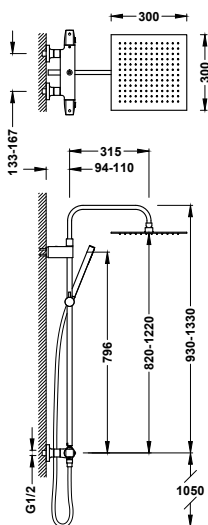

2-way Over-wall thermostatic shower mixer tap set

- With diverter integrated into the flow regulator.
- Square-round handle.
- Telescopic shower bar.
- Stainless steel adjustable shower head: 300x300 mm.
- Adjustable and sliding support for hand shower.
- Anti-limescale brass hand shower.
- Satin hose.

Set di miscelatore termostatico a muro Over-wall 2 getti per doccia

- Con inverter incorporato nel regolatore di flusso.
- Manopola quadrata-rotonda.
- Colonna doccia telescopica.
- Soffione doccia orientabile in acciaio inossidabile: 300x300 mm.
- Supporto scorrevole e orientabile per doccia.
- Doccino anticalcare in ottone.
- Flessibile satinato.

■ 19039307	596,00
■ 19039307NM	924,00
■ 19039307BM	924,00
■ 19039307AC	924,00
■ 19039307KMB	924,00
■ 19039307OM	1.311,00
■ 19039307OPM	1.311,00

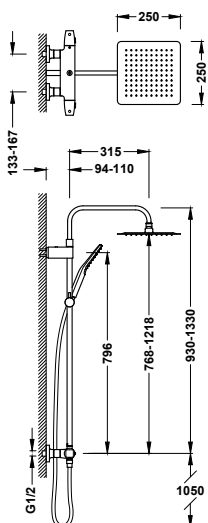

2-way Over-wall thermostatic shower mixer tap set

- With diverter integrated into the flow regulator.
- Square-round handle.
- Telescopic shower bar.
- Stainless steel adjustable shower head: 250x250 mm.
- Adjustable and sliding support for hand shower.
- Anti-limescale hand showers: 96x110 mm. (3 stream types).
- Satin hose.

Set di miscelatore termostatico a muro Over-wall 2 getti per doccia

- Con inverter incorporato nel regolatore di flusso.
- Manopola quadrata-rotonda.
- Colonna doccia telescopica.
- Soffione doccia orientabile in acciaio inossidabile: 250x250 mm.
- Supporto scorrevole e orientabile per doccia.
- Doccino anticalcare: 96x110 mm. (3 tipi di getto).
- Flessibile satinato.

■ 19038706	583,00
------------	--------

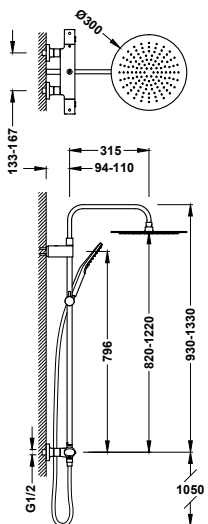
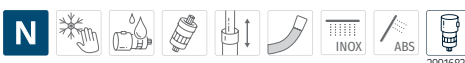

2-way Over-wall thermostatic shower mixer tap set

- With diverter integrated into the flow regulator.
- Oval handle.
- Telescopic shower bar.
- Stainless steel adjustable shower head: Ø 300 mm.
- Adjustable and sliding support for hand shower.
- Anti-limescale hand showers: Ø 110 mm. (3 stream types).
- Satin hose.

Set di miscelatore termostatico a muro Over-wall 2 getti per doccia

- Con inverter incorporato nel regolatore di flusso.
- Manopola ovale.
- Colonna doccia telescopica.
- Soffione doccia orientabile in acciaio inossidabile: Ø 300 mm.
- Supporto scorrevole e orientabile per doccia.
- Doccino anticalcare: Ø 110 mm. (3 tipi di getto).
- Flessibile satinato.

■ 19038705	580,00
■ 19038705NM	899,00
■ 19038705BM	899,00
■ 19038705AC	899,00
■ 19038705KMB	899,00
■ 19038705OM	1.276,00
■ 19038705OPM	1.276,00



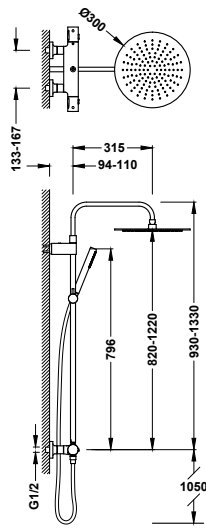

2-way Over-wall thermostatic shower mixer tap set

- With diverter integrated into the flow regulator.
- Round handle.
- Telescopic shower bar.
- Stainless steel adjustable shower head: Ø 300 mm.
- Adjustable and sliding support for hand shower.
- Anti-limescale brass hand shower.
- Satin hose.

19039302	559,00
19039302NM	866,00
19039302BM	866,00
19039302AC	866,00
19039302KMB	866,00
19039302OM	1.230,00
19039302OPM	1.230,00

Set di miscelatore termostatico a muro Over-wall 2 getti per doccia

- Con inverter incorporato nel regolatore di flusso.
- Manopola rotonda.
- Colonna doccia telescopica.
- Soffione doccia orientabile in acciaio inossidabile: Ø 300 mm.
- Supporto scorrevole e orientabile per doccino.
- Doccino anticalcare in ottone.
- Flessibile satinato.

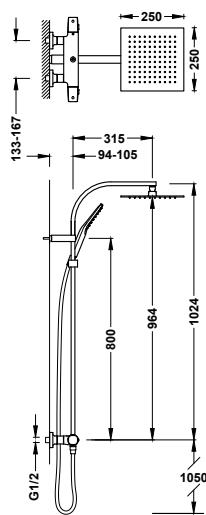

2-way Over-wall thermostatic shower mixer tap set

- With diverter integrated into the flow regulator.
- Handle with rounded edges.
- Stainless steel adjustable shower head: 250x250 mm.
- Adjustable and sliding support for hand shower.
- Anti-limescale hand showers: 96x110 mm. (3 stream types).
- Satin hose.

19039311	550,00
----------	--------

Set di miscelatore termostatico a muro Over-wall 2 getti per doccia

- Con inverter incorporato nel regolatore di flusso.
- Manopola con bordi arrotondati.
- Soffione doccia orientabile in acciaio inossidabile: 250x250 mm.
- Supporto scorrevole e orientabile per doccino.
- Doccino anticalcare: 96x110 mm. (3 tipi di getto).
- Flessibile satinato.

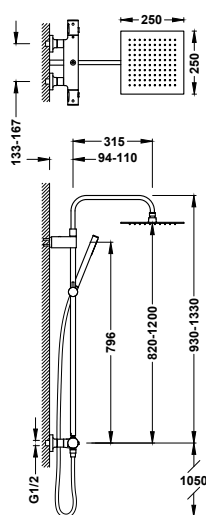

2-way Over-wall thermostatic shower mixer tap set

- With diverter integrated into the flow regulator.
- Telescopic shower bar.
- Round handle.
- Stainless steel adjustable shower head: 250x250 mm.
- Adjustable and sliding support for hand shower.
- Anti-limescale brass hand shower.
- Satin hose.

19038709	539,00
----------	--------

Set di miscelatore termostatico a muro Over-wall 2 getti per doccia

- Con inverter incorporato nel regolatore di flusso.
- Colonna doccia telescopica.
- Manopola rotonda.
- Soffione doccia orientabile in acciaio inossidabile: 250x250 mm.
- Supporto scorrevole e orientabile per doccino.
- Doccino anticalcare in ottone.
- Flessibile satinato.



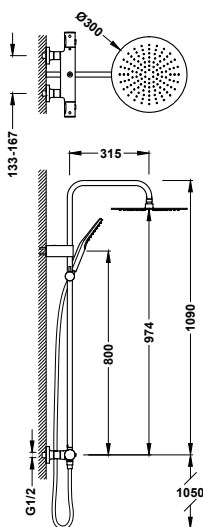

2-way Over-wall thermostatic shower mixer tap set

- With diverter integrated into the flow regulator.
- Round handle.
- Stainless steel adjustable shower head: Ø300 mm.
- Adjustable and sliding support for hand shower.
- Anti-limescale hand showers: Ø110 mm. (3 stream types).
- Satin hose.

Set di miscelatore termostatico a muro Over-wall 2 getti per doccia

- Con inverter incorporato nel regolatore di flusso.
- Manopola rotonda.
- Soffione doccia orientabile in acciaio inossidabile: Ø300 mm.
- Supporto scorrevole e orientabile per doccia.
- Doccino anticalcare: Ø110 mm. (3 tipi di getto).
- Flessibile satinato.

■ 19039314	503,00
■ 19039314NM	780,00
■ 19039314BM	780,00
■ 19039314AC	780,00
■ 19039314KMB	780,00
■ 19039314OM	1.106,00
■ 19039314OPM	1.106,00

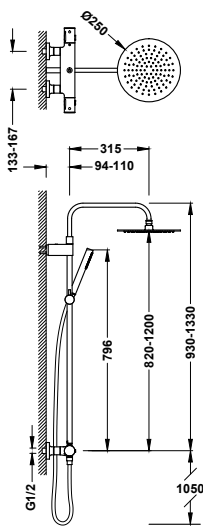

2-way Over-wall thermostatic shower mixer tap set

- With diverter integrated into the flow regulator.
- Telescopic shower bar.
- Round handle.
- Stainless steel adjustable shower head: 300x300 mm.
- Adjustable and sliding support for hand shower.
- Anti-limescale brass hand shower.
- Satin hose.

Set di miscelatore termostatico a muro Over-wall 2 getti per doccia

- Con inverter incorporato nel regolatore di flusso.
- Colonna doccia telescopica.
- Manopola rotonda.
- Soffione doccia orientabile in acciaio inossidabile: 300x300 mm.
- Supporto scorrevole e orientabile per doccia.
- Doccino anticalcare in ottone.
- Flessibile satinato.

■ 19038708	489,00
------------	--------

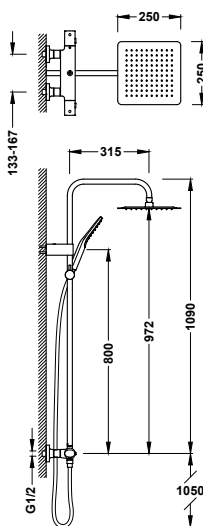
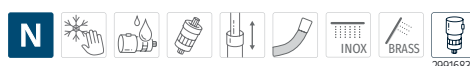

2-way Over-wall thermostatic shower mixer tap set

- With diverter integrated into the flow regulator.
- Oval handle.
- Stainless steel adjustable shower head: 250x250 mm.
- Adjustable and sliding support for hand shower.
- Anti-limescale hand showers: 96x110 mm. (3 stream types).
- Satin hose.

Set di miscelatore termostatico a muro Over-wall 2 getti per doccia

- Con inverter incorporato nel regolatore di flusso.
- Manopola ovale.
- Soffione doccia orientabile in acciaio inossidabile: 250x250 mm.
- Supporto scorrevole e orientabile per doccia.
- Doccino anticalcare: 96x110 mm. (3 tipi di getto).
- Flessibile satinato.

■ 19039313	486,00
------------	--------



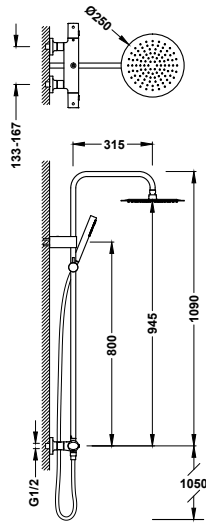

2-way Over-wall thermostatic shower mixer tap set

19039312

465,00

- With diverter integrated into the flow regulator.
- Oval handle.
- Stainless steel adjustable shower head: 300x300 mm.
- Adjustable and sliding support for hand shower.
- Anti-limescale brass hand shower.
- Satin hose.

Set di miscelatore termostatico a muro Over-wall 2 getti per doccia

- Con inverter incorporato nel regolatore di flusso.
- Manopola ovale.
- Soffione doccia orientabile in acciaio inossidabile: 300x300 mm.
- Supporto scorrevole e orientabile per doccia.
- Doccino anticalcare in ottone.
- Flessibile satinato.

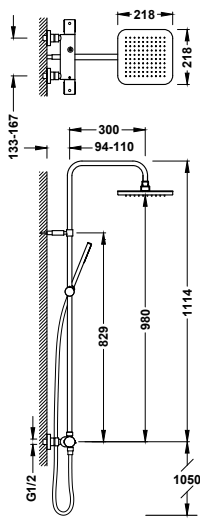

2-way Over-wall thermostatic shower mixer tap set

19039318

443,00

- With diverter integrated into the flow regulator.
- ABS round handle.
- Adjustable shower head: 218x218 mm.
- Adjustable and sliding support for hand shower.
- Anti-limescale hand shower.
- Metal hose.

Set di miscelatore termostatico a muro Over-wall 2 getti per doccia

- Con inverter incorporato nel regolatore di flusso.
- Manopola rotonda in ABS.
- Soffione doccia orientabile: 218x218 mm.
- Supporto scorrevole e orientabile per doccia.
- Doccino anticalcare
- Flessibile in metallo.

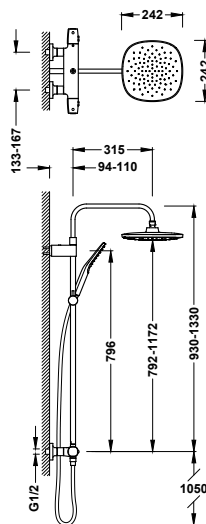

2-way Over-wall thermostatic shower mixer tap set

19038707

435,00

- With diverter integrated into the flow regulator.
- Telescopic shower bar.
- Handle with rounded edges.
- Adjustable shower head: 242x242 mm.
- Adjustable and sliding support for hand shower.
- Anti-limescale hand showers: 120x120 mm. (3 stream types).
- Satin hose.

Set di miscelatore termostatico a muro Over-wall 2 getti per doccia

- Con inverter incorporato nel regolatore di flusso.
- Colonna doccia telescopica.
- Manopola con bordi arrotondati.
- Soffione doccia orientabile: 242x242 mm.
- Supporto scorrevole e orientabile per doccia.
- Doccino anticalcare: 120x120 mm. (3 tipi di getto).
- Flessibile satinato.



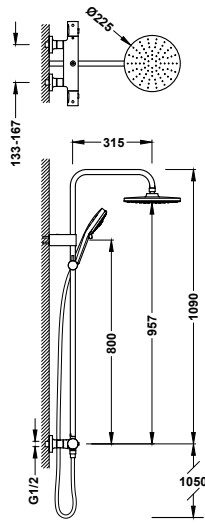

2-way Over-wall thermostatic shower mixer tap set

19039315 398,00

- With diverter integrated into the flow regulator.
- Round handle.
- Adjustable shower head: Ø 225 mm. Self-cleaning anti-limescale nozzles
- Adjustable and sliding support for hand shower.
- Anti-limescale hand showers: Ø110 mm. (5 stream types). Self-cleaning anti-limescale nozzles
- Satin hose.

Set di miscelatore termostatico a muro Over-wall 2 getti per doccia

- Con inverter incorporato nel regolatore di flusso.
- Manopola rotonda.
- Soffione doccia orientabile: Ø225 mm. Fori anticalcare autopulenti.
- Supporto scorrevole e orientabile per doccia.
- Doccino anticalcare: Ø110 mm. (5 tipi di getto). Fori anticalcare autopulenti.
- Flessibile satinato.



THERMOSTATIC SETS FOR BATH / SET TERMOSTATICI PER VASCA

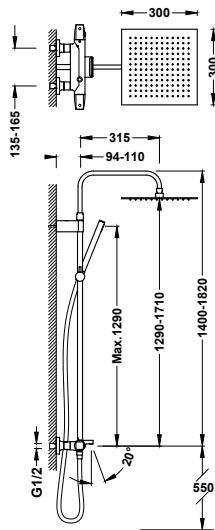

3-way Over-wall thermostatic mixer tap set for bath and shower

19031215	685,00
19031215NM	1.062,00
19031215BM	1.062,00
19031215AC	1.062,00
19031215KMB	1.062,00
19031215OM	1.507,00
19031215OPM	1.507,00

- Inverter integrated into the flow regulator.
- Square-round handle.
- Telescopic shower bar.
- Stainless steel adjustable shower head: 300x300 mm.
- Adjustable and sliding support for hand shower.
- Anti-limescale brass hand shower.
- Satin hose.

Set di miscelatore termostatico a muro Over-wall 3 getti per vasca e doccia

- Inverter incorporato nel regolatore di flusso.
- Manopola quadrata-rotonda.
- Colonna doccia telescopica.
- Soffione doccia orientabile in acciaio inossidabile: 300x300 mm.
- Supporto scorrevole e orientabile per doccia.
- Doccino anticalcare in ottone.
- Flessibile satinato.

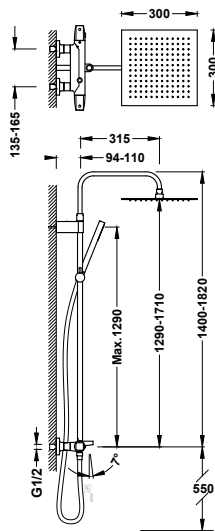
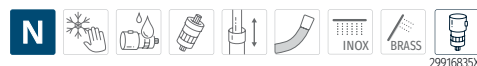

3-way Over-wall thermostatic mixer tap set for bath and shower

19031205	643,00
19031205NM	997,00
19031205BM	997,00
19031205AC	997,00
19031205KMB	997,00
19031205OM	1.415,00
19031205OPM	1.415,00

- Inverter integrated into the flow regulator.
- Square-round handle.
- Telescopic shower bar.
- Stainless steel adjustable shower head: 300x300 mm.
- Adjustable and sliding support for hand shower.
- Anti-limescale brass hand shower.
- Satin hose.

Set di miscelatore termostatico a muro Over-wall 3 getti per vasca e doccia

- Inverter incorporato nel regolatore di flusso.
- Manopola quadrata-rotonda.
- Colonna doccia telescopica.
- Soffione doccia orientabile in acciaio inossidabile: 300x300 mm.
- Supporto scorrevole e orientabile per doccia.
- Doccino anticalcare in ottone.
- Flessibile satinato.



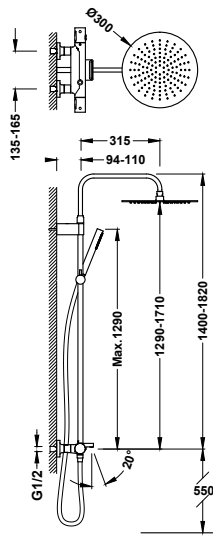

3-way Over-wall thermostatic mixer tap set for bath and shower

- With diverter integrated into the flow regulator.
- Round handle.
- Telescopic shower bar.
- Stainless steel adjustable shower head: Ø 300 mm.
- Adjustable and sliding support for hand shower.
- Anti-limescale brass hand shower.
- Satin hose.

19031212	654,00
19031212NM	1.014,00
19031212BM	1.014,00
19031212AC	1.014,00
19031212KMB	1.014,00
19031212OM	1.439,00
19031212OPM	1.439,00

Set di miscelatore termostatico a muro Over-wall 3 getti per vasca e doccia

- Inverter incorporato nel regolatore di flusso.
- Manopola rotonda.
- Colonna doccia telescopica.
- Soffione doccia orientabile in acciaio inossidabile: Ø 300 mm.
- Supporto scorrevole e orientabile per doccino.
- Doccino anticalcare in ottone.
- Flessibile satinato.

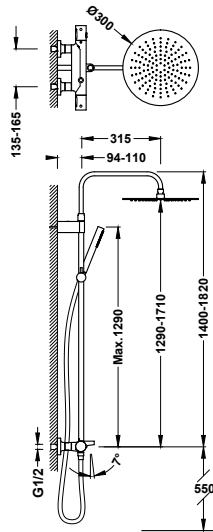

3-way Over-wall thermostatic mixer tap set for bath and shower

- With diverter integrated into the flow regulator.
- Round handle.
- Telescopic shower bar.
- Stainless steel adjustable shower head: Ø 300 mm.
- Adjustable and sliding support for hand shower.
- Anti-limescale brass hand shower.
- Satin hose.

19031202	612,00
19031202NM	949,00
19031202BM	949,00
19031202AC	949,00
19031202KMB	949,00
19031202OM	1.346,00
19031202OPM	1.346,00

Set di miscelatore termostatico a muro Over-wall 3 getti per vasca e doccia

- Inverter incorporato nel regolatore di flusso.
- Manopola rotonda.
- Colonna doccia telescopica.
- Soffione doccia orientabile in acciaio inossidabile: Ø 300 mm.
- Supporto scorrevole e orientabile per doccino.
- Doccino anticalcare in ottone.
- Flessibile satinato.



THERMOSTATIC TAPS FOR SHOWER / RUBINETTI TERMOSTATICI PER DOCCIA

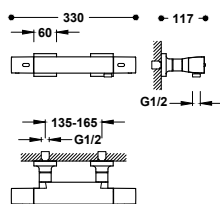

Over-wall thermostatic tap for the shower

Anti-limescale brass hand shower. Adjustable support for hand shower. Satin hose. Square handle.

Rubinetto termostatico a muro Over-wall per doccia

Doccino anticalcare in ottone. Supporto orientabile per doccino. Flessibile satinato. Manopola quadrata.

	19016469	278,00
	19016469NM	431,00
	19016469BM	431,00
	19016469AC	431,00
	19016469OM	612,00



29916836XX



Thermostatic tap without accessories

Rubinetto termostatico non accessoriato



	19016406	231,00
--	----------	--------

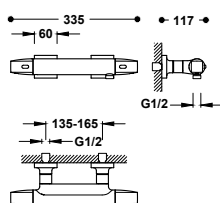

Over-wall thermostatic tap for the shower

Anti-limescale brass hand shower. Adjustable support for hand shower. Satin hose. Square-round handle.

Rubinetto termostatico a muro Over-wall per doccia

Doccino anticalcare in ottone. Supporto orientabile per doccino. Flessibile satinato. Manopola quadrata-rotonda.

	19016459	236,00
	19016459NM	366,00
	19016459BM	366,00
	19016459AC	366,00
	19016459KMB	366,00
	19016459OM	520,00
	19016459OPM	520,00



29916835XX



Thermostatic tap without accessories

Rubinetto termostatico non accessoriato



	19016405	189,00
--	----------	--------

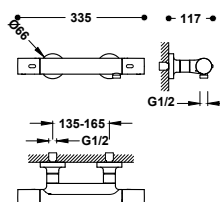

Over-wall thermostatic tap for the shower

Anti-limescale brass hand shower. Adjustable support for hand shower. Satin hose. Round handle.

Rubinetto termostatico a muro Over-wall per doccia

Doccino anticalcare in ottone. Supporto orientabile per doccino. Flessibile satinato. Manopola rotonda.

	19016429	236,00
	19016429NM	366,00
	19016429BM	366,00
	19016429AC	366,00
	19016429KMB	366,00
	19016429OM	520,00
	19016429OPM	520,00



29916832XX



Thermostatic tap without accessories

Rubinetto termostatico non accessoriato



	19016402	189,00
--	----------	--------



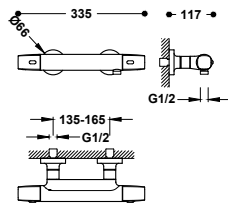

Over-wall thermostatic tap for the shower

Anti-limescale brass hand shower. Adjustable support for hand shower. Satin hose. Handle with rounded edges.

Rubinetto termostatico a muro Over-wall per doccia

Doccino anticalcare in ottone. Supporto orientabile per doccino. Flessibile satinato. Manopola con bordi arrotondati.

	19016449	236,00
	19016449NM	366,00
	19016449BM	366,00
	19016449AC	366,00
	19016449KMB	366,00
	19016449OM	520,00
	19016449OPM	520,00



Thermostatic tap without accessories

Rubinetto termostatico non accessoriato



	19016404	189,00
--	----------	--------

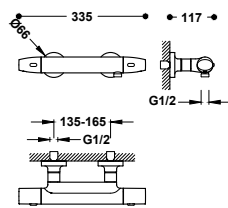

Over-wall thermostatic tap for the shower

Anti-limescale brass hand shower. Adjustable support for hand shower. Satin hose. Oval handle.

Rubinetto termostatico a muro Over-wall per doccia

Doccino anticalcare in ottone. Supporto orientabile per doccino. Flessibile satinato. Manopola ovale.

	19016439	236,00
	19016439NM	366,00
	19016439BM	366,00
	19016439AC	366,00
	19016439KMB	366,00
	19016439OM	520,00
	19016439OPM	520,00



Thermostatic tap without accessories

Rubinetto termostatico non accessoriato



	19016403	189,00
--	----------	--------

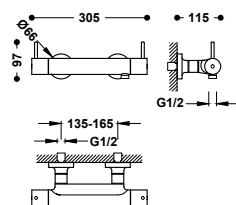

Wall-mounted thermostatic shower mixer tap with ergonomic handles

Without accessories. Suitable for people with physical disabilities.

Miscelatore termostatico a muro per doccia con leve ergonomiche

Senza complementi. Indicato per persone a mobilità ridotta.

	19026410	235,00
--	----------	--------



THERMOSTATIC TAPS FOR BATH / RUBINETTI TERMOSTATICI PER VASCA

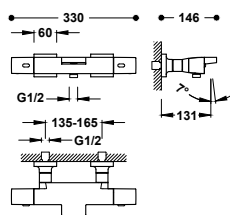

Over-wall thermostatic mixer tap for bath and shower

Anti-limescale brass hand shower. Adjustable support for hand shower. Satin hose. Square handle.

Vasca-Doccia termostatica Over-wall

Doccino anticalcare in ottone. Supporto orientabile per doccino. Flessibile satinato. Manopola quadrata.



- 19017469 373,00
- 19017469NM 550,00
- 19017469BM 550,00
- 19017469AC 550,00
- 19017469OM 710,00



Thermostatic tap without accessories
Rubinetto termostatico non accessoriato



- 19017406 326,00

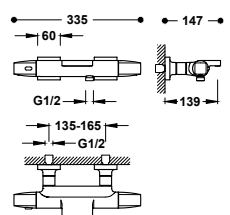

Over-wall thermostatic mixer tap for bath and shower

Anti-limescale brass hand shower. Adjustable support for hand shower. Satin hose. Square-round handle.

Vasca-Doccia termostatica Over-wall

Doccino anticalcare in ottone. Supporto orientabile per doccino. Flessibile satinato. Manopola quadrata-rotonda.



- 19017489 388,00
- 19017489NM 601,00
- 19017489BM 601,00
- 19017489AC 601,00
- 19017489KMB 601,00
- 19017489OM 854,00
- 19017489OPM 854,00



Thermostatic tap without accessories
Rubinetto termostatico non accessoriato



- 19017415 341,00

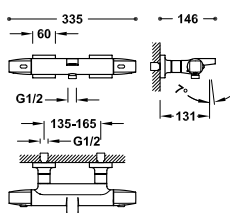

Over-wall thermostatic mixer tap for bath and shower

Anti-limescale brass hand shower. Adjustable support for hand shower. Satin hose. Square-round handle.

Vasca-Doccia termostatica Over-wall

Doccino anticalcare in ottone. Supporto orientabile per doccino. Flessibile satinato. Manopola quadrata-rotonda.



- 19017459 320,00
- 19017459NM 496,00
- 19017459BM 496,00
- 19017459AC 496,00
- 19017459KMB 496,00
- 19017459OM 705,00
- 19017459OPM 705,00



Thermostatic tap without accessories
Rubinetto termostatico non accessoriato



- 19017405 273,00



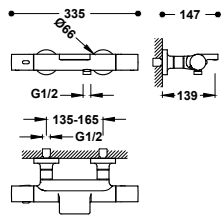

Over-wall thermostatic mixer tap for bath and shower
 Anti-limescale brass hand shower. Adjustable support for hand shower. Satin hose. Round handle.

Vasca-Doccia termostatica Over-wall

Doccino anticalcare in ottone. Supporto orientabile per doccia. Flessibile satinato. Manopola rotonda.



- 19017428 388,00
- 19017428NM 601,00
- 19017428BM 601,00
- 19017428AC 601,00
- 19017428KMB 601,00
- 19017428OM 854,00
- 19017428OPM 854,00



Thermostatic tap without accessories
Rubinetto termostatico non accessoriato



- 19017412 341,00

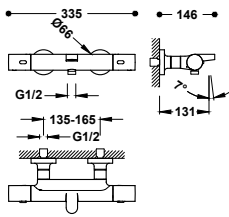

Over-wall thermostatic mixer tap for bath and shower
 Anti-limescale brass hand shower. Adjustable support for hand shower. Satin hose. Round handle.

Vasca-Doccia termostatica Over-wall

Doccino anticalcare in ottone. Supporto orientabile per doccia. Flessibile satinato. Manopola rotonda.



- 19017429 320,00
- 19017429NM 496,00
- 19017429BM 496,00
- 19017429AC 496,00
- 19017429KMB 496,00
- 19017429OM 705,00
- 19017429OPM 705,00



Thermostatic tap without accessories
Rubinetto termostatico non accessoriato



- 19017402 273,00

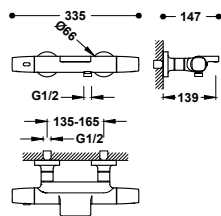

Over-wall thermostatic mixer tap for bath and shower
 Anti-limescale brass hand shower. Adjustable support for hand shower. Satin hose. Handle with rounded edges.

Vasca-Doccia termostatica Over-wall

Doccino anticalcare in ottone. Supporto orientabile per doccia. Flessibile satinato. Manopola con bordi arrotondati.



- 19017499 388,00
- 19017499NM 601,00
- 19017499BM 601,00
- 19017499AC 601,00
- 19017499KMB 601,00
- 19017499OM 854,00
- 19017499OPM 854,00



Thermostatic tap without accessories
Rubinetto termostatico non accessoriato



- 19017414 341,00

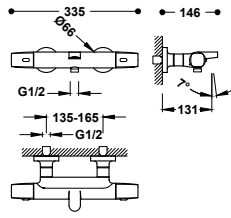

Over-wall thermostatic mixer tap for bath and shower
 Anti-limescale brass hand shower. Adjustable support for hand shower. Satin hose. Handle with rounded edges.

Vasca-Doccia termostatica Over-wall

Doccino anticalcare in ottone. Supporto orientabile per doccino. Flessibile satinato. Manopola con bordi arrotondati.



- 19017449 320,00
- 19017449NM 496,00
- 19017449BM 496,00
- 19017449AC 496,00
- 19017449KMB 496,00
- 19017449OM 705,00
- 19017449OPM 705,00



Thermostatic tap without accessories
Rubinetto termostatico non accessoriato



- 19017404 273,00

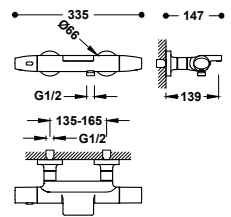

Over-wall thermostatic mixer tap for bath and shower
 Anti-limescale brass hand shower. Adjustable support for hand shower. Satin hose. Oval handle.

Vasca-Doccia termostatica Over-wall

Doccino anticalcare in ottone. Supporto orientabile per doccino. Flessibile satinato. Manopola ovale.



- 19017479 388,00
- 19017479NM 601,00
- 19017479BM 601,00
- 19017479AC 601,00
- 19017479KMB 601,00
- 19017479OM 854,00
- 19017479OPM 854,00



Thermostatic tap without accessories
Rubinetto termostatico non accessoriato



- 19017413 341,00

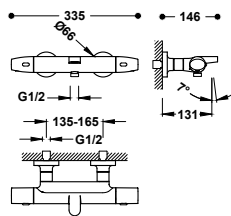

Over-wall thermostatic mixer tap for bath and shower
 Anti-limescale brass hand shower. Adjustable support for hand shower. Satin hose. Oval handle.

Vasca-Doccia termostatica Over-wall

Doccino anticalcare in ottone. Supporto orientabile per doccino. Flessibile satinato. Manopola ovale.



- 19017439 320,00
- 19017439NM 496,00
- 19017439BM 496,00
- 19017439AC 496,00
- 19017439KMB 496,00
- 19017439OM 705,00
- 19017439OPM 705,00



Thermostatic tap without accessories
Rubinetto termostatico non accessoriato



- 19017403 273,00



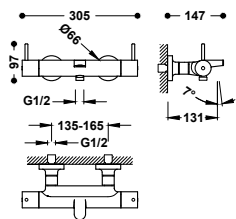

Wall-mounted thermostatic mixer tap for bath and shower with ergonomic handles

19027410

295,00

Without accessories. Inverter integrated into the flow regulator. Suitable for people with physical disabilities.

Miscelatore termostatico a muro per vasca e doccia con leve ergonomiche

Senza complementi. Inverter incorporato nel regolatore di flusso. Indicato per persone a mobilità ridotta.



DESIGNED BY YOU

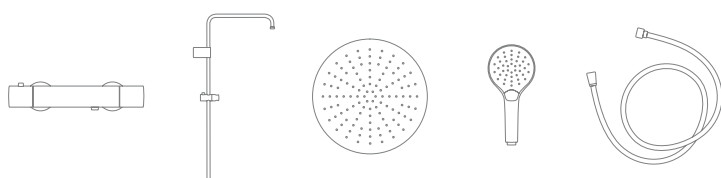

Your very own Tres tap, designed by you and for you. A personalised tap to create your perfect shower.

Il tuo rubinetto Tres, progettato da e per te. Un rubinetto personalizzato per creare la tua doccia perfetta.

Go to the website to design your Over-wall tap:

Vai al sito web per configurare il tuo rubinetto Over-wall:



1

FINISH / FINITURA

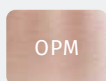
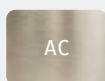

2

THERMOSTATIC TAP / RUBINETTO TERMOSTATICO



3

SHOWER BAR / ASTA PER DOCCIA



4

SHOWER HEAD / SOFFIONE

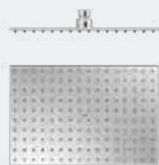

5

HAND SHOWER / DOCCINO



6

FLEXIBLE HOSE / FLESSIBILE





RAPID-BOX

Rapid-box is the concealed system from Tres for single-handle mixer tapware for you shower. With designs that combine all the collections from Tres. You can purchase the concealed box and the visible part separately, making it easier to plan your project and saving you time.

Rapid-box è il sistema da incasso di Tres per rubinetti doccia monocomando. Con modelli da abbinare a tutte le collezioni di Tres. La scatola da incasso e la parte a vista sono acquistabili separatamente, in questo modo la pianificazione del lavoro risulta semplificata ed efficiente.

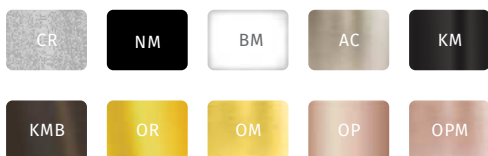





RAPID-BOX

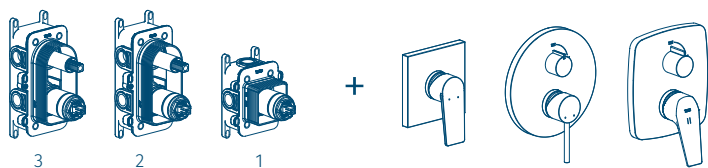

Buy separately

You can install the Rapid-box first before buying the visible part once everything is ready. This helps you simplify your project and save time.

Acquista separatamente

Puoi installare la Rapid-box e, successivamente, acquistare la parte a vista per installarla quando tutto è pronto. In questo modo la pianificazione del lavoro risulta semplificata ed efficiente.



The Rapid-box can be installed in front of or behind the wall, both in masonry and lightweight plasterboard walls (Pladur type).

La scatola incassata Rapid-box può essere installata anteriormente o posteriormente alla parete, sia nelle pareti in muratura che in quelle in cartongesso leggero (tipo Pladur).



The visible parts are **not too long**, so you gain extra usable space inside the shower.

I pezzi mostrati hanno una **profondità ridotta**, permettendo di guadagnare più spazio utilizzabile all'interno della doccia.



You only need a **minimum depth of 56 mm** to install the recessed box.

Per l'installazione della cassetta a incasso sono sufficienti **56 mm di profondità minima**.



The visible parts are available in **various finishes** and designs that can be combined with the Tres collections.

I pezzi mostrati sono disponibili in **varie finiture** e modelli da abbinare alle collezioni Tres.



The concealed box insulates the brass body from heat transfer to the wall, and being **watertight**, prevents water from filtering through the wall in the event of a leak. The waterproof seal **prevents damp**.

La scatola incassata isola la trasmissione di temperatura del corpo in ottone verso la parete. Essendo **a tenuta stagna** impedisce all'acqua di penetrare attraverso la parete in caso di perdite. La giunzione impermeabile **previene l'umidità**.



With the 2/3-way single-lever mixers you can change between the **2/3 different water outlets** by just turning the distributor.

Per il miscelatore monocomando a 2/3 getti, con una semplice rotazione del distributore è possibile passare tra le **2/3 prese d'acqua disponibili**.



The **dampers** prevent noise transmission from the tap to the wall and piping.

Gli **ammortizzatori** impediscono la trasmissione del rumore del rubinetto alla parete e ai tubi.

CONCEALED BOX / SCATOLA DA INCASSO

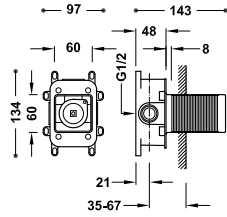

Concealed 1-way Rapid-box with single-handle mixer tap for shower

20827810 80,00

Concealed body with acoustic buffers. ABS embedding box. Anti-moisture seal.

Scatola da incasso a 1 via Rapid-box con miscelatore monocomando per doccia

Corpo incassato con smorzatori acustici. Scatola da incasso in ABS. Guarnizione antiumidità.



1-WAY VISIBLE PARTS / ELEMENTI A VISTA A 1 GETTO

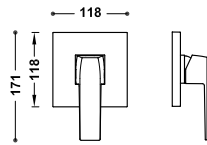

Visible part for concealed 1-way Rapid-box

Only visible part. Includes trim plate, control, bush and concealed attachment screw. Complete with concealed Rapid-box ref.: 20827810.

- 20227810 89,00
- 20227810NM 138,00
- 20227810BM 138,00
- 20227810AC 138,00
- 20227810KMB 138,00
- 20227810OR 196,00
- 20227810OM 196,00

Pezzo vista per cassa da incasso a 1 via Rapid-box

Solo parte vista. Include piastra decorativa, comando, boccola e vite di fissaggio occulta. Completare con scatola da incasso Rapid-box rif.: 20827810.

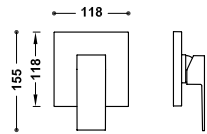

Visible part for concealed 1-way Rapid-box

Only visible part. Includes trim plate, control, bush and concealed attachment screw. Complete with concealed Rapid-box ref.: 20827810.

- 10627810 89,00
- 10627810NM 138,00
- 10627810BM 138,00
- 10627810AC 138,00
- 10627810OR 196,00
- 10627810OM 196,00

Pezzo vista per cassa da incasso a 1 via Rapid-box

Solo parte vista. Include piastra decorativa, comando, boccola e vite di fissaggio occulta. Completare con scatola da incasso Rapid-box rif.: 20827810.

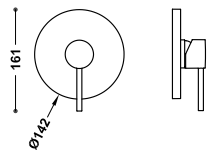

Visible part for concealed 1-way Rapid-box

Only visible part. Includes trim plate, control, bush and concealed attachment screw. Complete with concealed Rapid-box ref.: 20827810.

- 26227810 89,00
- 26227810NM 138,00
- 26227810BM 138,00
- 26227810AC 138,00
- 26227810KM 138,00
- 26227810KMB 138,00
- 26227810OR 196,00
- 26227810OM 196,00
- 26227810OP 196,00
- 26227810OPM 196,00

Pezzo vista per cassa da incasso a 1 via Rapid-box

Solo parte vista. Include piastra decorativa, comando, boccola e vite di fissaggio occulta. Completare con scatola da incasso Rapid-box rif.: 20827810.

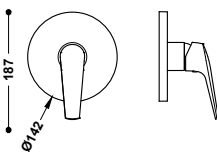

Visible part for concealed 1-way Rapid-box

Only visible part. Includes trim plate, control, bush and concealed attachment screw. Complete with concealed Rapid-box ref.: 20827810.

- 28127810 79,00
- 28127810NM 122,00
- 28127810AC 122,00
- 28127810OPM 173,00

Pezzo vista per cassa da incasso a 1 via Rapid-box

Solo parte vista. Include piastra decorativa, comando, boccola e vite di fissaggio occulta. Completare con scatola da incasso Rapid-box rif.: 20827810.

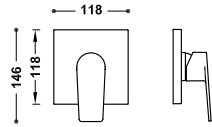

Visible part for concealed 1-way Rapid-box

Only visible part. Includes trim plate, control, bush and concealed attachment screw. Complete with concealed Rapid-box ref: 20827810.

Pezzo vista per cassa da incasso a 1 via Rapid-box

Solo parte vista. Include piastra decorativa, comando, boccola e vite di fissaggio occulta. Completare con scatola da incasso Rapid-box rif: 20827810.

	21127810	79,00
	21127810NM	122,00
	21127810BM	122,00
	21127810AC	122,00
	21127810KM	122,00
	21127810KMB	122,00
	21127810OR	173,00
	21127810OM	173,00
	21127810OP	173,00
	21127810OPM	173,00

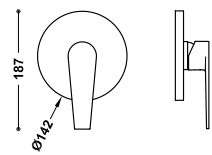

Visible part for concealed 1-way Rapid-box

Only visible part. Includes trim plate, control, bush and concealed attachment screw. Complete with concealed Rapid-box ref: 20827810.

Pezzo vista per cassa da incasso a 1 via Rapid-box

Solo parte vista. Include piastra decorativa, comando, boccola e vite di fissaggio occulta. Completare con scatola da incasso Rapid-box rif: 20827810.

	20527810	79,00
---	----------	-------

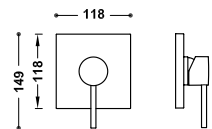

Visible part for concealed 1-way Rapid-box

Only visible part. Includes trim plate, control, bush and concealed attachment screw. Complete with concealed Rapid-box ref: 20827810.

Pezzo vista per cassa da incasso a 1 via Rapid-box

Solo parte vista. Include piastra decorativa, comando, boccola e vite di fissaggio occulta. Completare con scatola da incasso Rapid-box rif: 20827810.

	06227810	79,00
--	----------	-------

CONCEALED BOX / SCATOLA DA INCASSO

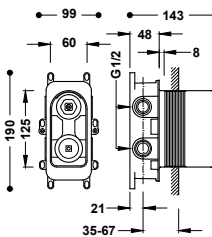

Concealed 2-way Rapid-box with single-handle mixer tap for shower and bath

Concealed body with acoustic buffers. ABS embedding box. Anti-moisture seal. 2-way ceramic distributor.

Scatola da incasso a 2 vie Rapid-box con miscelatore monocomando per doccia e vasca da bagno

Corpo incassato con smorzatori acustici. Scatola da incasso in ABS. Guarnizione antiumidità. Erogatore in ceramica a 2 getti.

20828110	90,00
----------	-------



2-WAY VISIBLE PARTS / ELEMENTI A VISTA A 2 GETTI

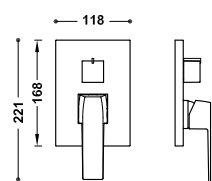







Visible part for concealed 2-way Rapid-box

Only visible part. Includes trim plate, control, distribution handle and concealed attachment screw. Complete with concealed Rapid-box ref: 20828110.

Pezzo vista per cassa da incasso a 2 vie Rapid-box

Solo parte vista. Include piastra decorativa, comando, volante distributore e vite di fissaggio occulta. Completare con scatola da incasso Rapid-box rif: 20828110.

	20228110	116,00
	20228110NM	179,00
	20228110BM	179,00
	20228110AC	179,00
	20228110KMB	179,00
	20228110OR	254,00
	20228110OM	254,00

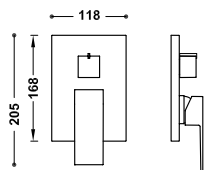







Visible part for concealed 2-way Rapid-box

Only visible part. Includes trim plate, control, distribution handle and concealed attachment screw. Complete with concealed Rapid-box ref.: 20828110.

Pezzo vista per cassa da incasso a 2 vie Rapid-box

Solo parte vista. Include piastra decorativa, comando, volante distributore e vite di fissaggio occulta. Completare con scatola da incasso Rapid-box rif.: 20828110.

	10628110	116,00
	10628110NM	179,00
	10628110BM	179,00
	10628110AC	179,00
	10628110OR	254,00
	10628110OM	254,00

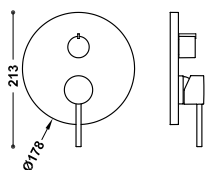









Visible part for concealed 2-way Rapid-box

Only visible part. Includes trim plate, control, distribution handle and concealed attachment screw. Complete with concealed Rapid-box ref.: 20828110.

Pezzo vista per cassa da incasso a 2 vie Rapid-box

Solo parte vista. Include piastra decorativa, comando, volante distributore e vite di fissaggio occulta. Completare con scatola da incasso Rapid-box rif.: 20828110.

	26228110	116,00
	26228110NM	179,00
	26228110BM	179,00
	26228110AC	179,00
	26228110KM	179,00
	26228110KMB	179,00
	26228110OR	254,00
	26228110OM	254,00
	26228110OP	254,00
	26228110OPM	254,00

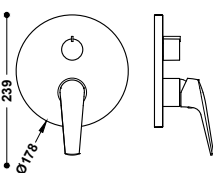





Visible part for concealed 2-way Rapid-box

Only visible part. Includes trim plate, control, distribution handle and concealed attachment screw. Complete with concealed Rapid-box ref.: 20828110.

Pezzo vista per cassa da incasso a 2 vie Rapid-box

Solo parte vista. Include piastra decorativa, comando, volante distributore e vite di fissaggio occulta. Completare con scatola da incasso Rapid-box rif.: 20828110.

	28128110	100,00
	28128110NM	155,00
	28128110AC	155,00
	28128110OPM	219,00

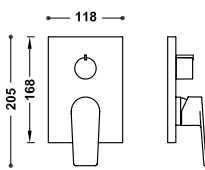











Visible part for concealed 2-way Rapid-box

Only visible part. Includes trim plate, control, distribution handle and concealed attachment screw. Complete with concealed Rapid-box ref.: 20828110.

Pezzo vista per cassa da incasso a 2 vie Rapid-box

Solo parte vista. Include piastra decorativa, comando, volante distributore e vite di fissaggio occulta. Completare con scatola da incasso Rapid-box rif.: 20828110.

	21128110	100,00
	21128110NM	155,00
	21128110BM	155,00
	21128110AC	155,00
	21128110KM	155,00
	21128110KMB	155,00
	21128110OR	219,00
	21128110OM	219,00
	21128110OP	219,00
	21128110OPM	219,00

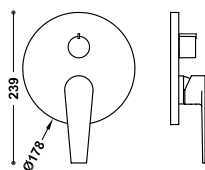

Visible part for concealed 2-way Rapid-box

Only visible part. Includes trim plate, control, distribution handle and concealed attachment screw. Complete with concealed Rapid-box ref.: 20828110.

Pezzo vista per cassa da incasso a 2 vie Rapid-box

Solo parte vista. Include piastra decorativa, comando, volante distributore e vite di fissaggio occulta. Completare con scatola da incasso Rapid-box rif.: 20828110.

	20528110	100,00
---	----------	--------

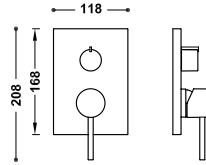

Visible part for concealed 2-way Rapid-box

06228110 100,00

Only visible part. Includes trim plate, control, distribution handle and concealed attachment screw. Complete with concealed Rapid-box ref.: 20828110.

Pezzo vista per cassa da incasso a 2 vie Rapid-box

Solo parte vista. Include piastra decorativa, comando, volante distributore e vite di fissaggio occulta. Completare con scatola da incasso Rapid-box rif.: 20828110.

CONCEALED BOX / SCATOLA DA INCASSO

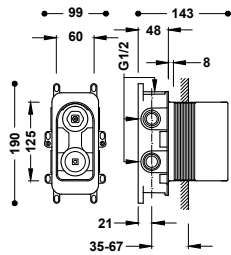

Concealed 3-way Rapid-box with single-handle mixer tap for shower and bath

20827310 95,00

Concealed body with acoustic buffers. ABS embedding box. Anti-moisture seal. 3-way ceramic distributor.

Scatola da incasso a 3 vie Rapid-box con miscelatore monocomando per doccia e vasca da bagno

Corpo incassato con smorzatori acustici. Scatola da incasso in ABS. Guarnizione antiumidità. Erogatore in ceramica a 3 getti.



3-WAY VISIBLE PARTS / ELEMENTI A VISTA A 3 GETTI

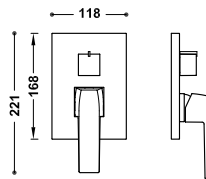

Visible part for concealed 3-way Rapid-box

- 20227310 125,00
- 20227310NM 194,00
- 20227310BM 194,00
- 20227310AC 194,00
- 20227310OR 275,00
- 20227310OM 275,00

Only visible part. Includes trim plate, control, distribution handle and concealed attachment screw. Complete with concealed Rapid-box ref.: 20827310.

Pezzo vista per cassa da incasso a 3 vie Rapid-box

Solo parte vista. Include piastra decorativa, comando, volante distributore e vite di fissaggio occulta. Completare con scatola da incasso Rapid-box rif.: 20827310.

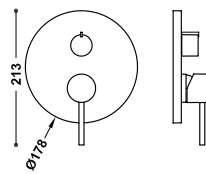

Visible part for concealed 3-way Rapid-box

- 26227310 125,00
- 26227310NM 194,00
- 26227310BM 194,00
- 26227310AC 194,00
- 26227310KM 194,00
- 26227310KMB 194,00
- 26227310OR 275,00
- 26227310OP 275,00
- 26227310OM 275,00
- 26227310OPM 275,00

Only visible part. Includes trim plate, control, distribution handle and concealed attachment screw. Complete with concealed Rapid-box ref.: 20827310.

Pezzo vista per cassa da incasso a 3 vie Rapid-box

Solo parte vista. Include piastra decorativa, comando, volante distributore e vite di fissaggio occulta. Completare con scatola da incasso Rapid-box rif.: 20827310.

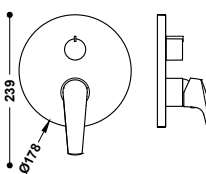

Visible part for concealed 3-way Rapid-box

- 28127310 109,00
- 28127310NM 169,00
- 28127310AC 169,00
- 28127310OPM 240,00

Only visible part. Includes trim plate, control, distribution handle and concealed attachment screw. Complete with concealed Rapid-box ref.: 20827310.

Pezzo vista per cassa da incasso a 3 vie Rapid-box

Solo parte vista. Include piastra decorativa, comando, volante distributore e vite di fissaggio occulta. Completare con scatola da incasso Rapid-box rif.: 20827310.



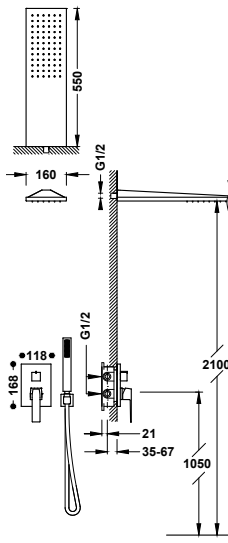

Rapid-box 2-way concealed single-handle shower mixer tap kit

- Concealed body included.
- 2-way ceramic distributor.
- Stainless steel wall-mounted shower head: 160x550 mm.
- Wall-mounted support for hand shower with water supply.
- Anti-limescale brass hand shower.
- Satin hose.

Kit di miscelatore monocomando a incasso 2 getti Rapid-box per doccia

- Corpo a incasso incluso.
- Erogatore in ceramica a 2 getti.
- Soffione doccia a muro in acciaio inossidabile: 160x550 mm.
- Supporto per doccia con presa d'acqua a muro.
- Doccino anticalcare in ottone.
- Flessibile satinato.

20228005	750,00
20228005NM	1.108,00
20228005BM	1.108,00
20228005AC	1.108,00
20228005OR	1.537,00
20228005OM	1.537,00

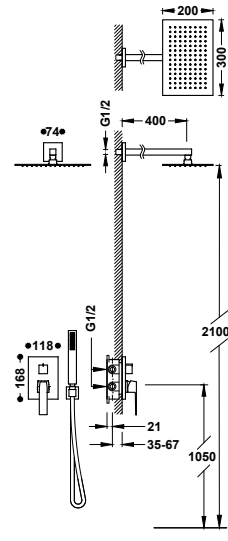
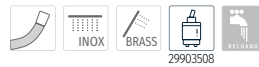

Rapid-box 2-way concealed single-handle shower mixer tap kit

- Concealed body included.
- 2-way ceramic distributor.
- Wall-mounted arm with adjustable stainless steel shower head: 300x200 mm.
- Wall-mounted support for hand shower with water supply.
- Anti-limescale brass hand shower.
- Satin hose.

Kit di miscelatore monocomando a incasso 2 getti Rapid-box per doccia

- Corpo a incasso incluso.
- Erogatore in ceramica a 2 getti.
- Braccio a muro con soffione doccia orientabile in acciaio inossidabile: 300x200 mm.
- Supporto per doccia con presa d'acqua a muro.
- Doccino anticalcare in ottone.
- Flessibile satinato.

20228004	595,00
20228004NM	868,00
20228004BM	868,00
20228004AC	868,00
20228004KMB	868,00
20228004OR	1.195,00
20228004OM	1.195,00

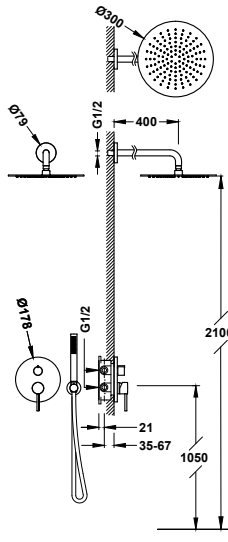
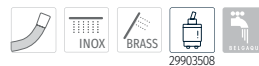

Rapid-box 2-way concealed single-handle shower mixer tap kit

- Concealed body included.
- 2-way ceramic distributor.
- Wall-mounted arm with adjustable stainless steel shower head: Ø 300 mm.
- Wall-mounted support for hand shower with water supply.
- Anti-limescale brass hand shower.
- Satin hose.

Kit di miscelatore monocomando a incasso 2 getti Rapid-box per doccia

- Corpo a incasso incluso.
- Erogatore in ceramica a 2 getti.
- Braccio a muro con soffione doccia orientabile in acciaio inossidabile: Ø 300 mm.
- Supporto per doccia con presa d'acqua a muro.
- Doccino anticalcare in ottone.
- Flessibile satinato.

26228004	495,00
26228004NM	712,00
26228004BM	712,00
26228004AC	712,00
26228004KM	712,00
26228004KMB	712,00
26228004OR	977,00
26228004OM	977,00
26228004OP	977,00
26228004OPM	977,00



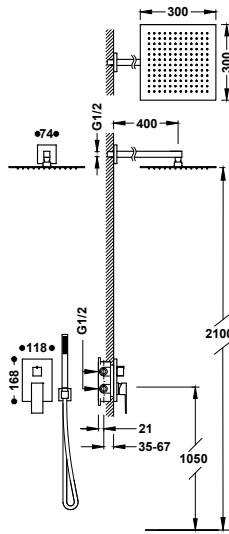

Rapid-box 2-way concealed single-handle shower mixer tap kit

- Concealed body included.
- 2-way ceramic distributor.
- Wall-mounted arm with adjustable stainless steel shower head: 300x300 mm.
- Wall-mounted support for hand shower with water supply.
- Anti-limescale brass hand shower.
- Satin hose.

Kit di miscelatore monocomando a incasso 2 getti Rapid-box per doccia

- Corpo a incasso incluso.
- Erogatore in ceramica a 2 getti.
- Braccio a muro con soffione doccia orientabile in acciaio inossidabile: 300x300 mm.
- Supporto per doccia con presa d'acqua a muro.
- Doccino anticalcare in ottone.
- Flessibile satinato.



00628004	582,00
00628004NM	853,00
00628004BM	853,00
00628004AC	853,00
00628004OR	1.174,00
00628004OM	1.174,00

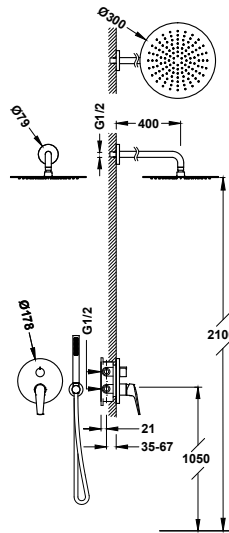

Rapid-box 2-way concealed single-handle shower mixer tap kit

- Concealed body included.
- 2-way ceramic distributor.
- Wall-mounted arm with stainless steel shower head: Ø 300 mm.
- Wall-mounted support for hand shower with water supply.
- Anti-limescale brass hand shower.
- Satin hose.

Kit di miscelatore monocomando a incasso 2 getti Rapid-box per doccia

- Corpo a incasso incluso.
- Erogatore in ceramica a 2 getti.
- Braccio a muro con soffione doccia orientabile in acciaio inossidabile: Ø 300 mm.
- Supporto per doccia con presa d'acqua a muro.
- Doccino anticalcare in ottone.
- Flessibile satinato.



28128004	474,00
28128004NM	691,00
28128004AC	691,00
28128004OPM	947,00

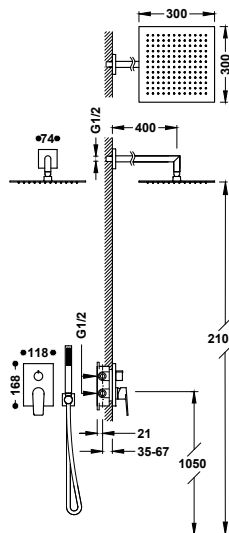

Rapid-box 2-way concealed single-handle shower mixer tap kit

- Concealed body included.
- 2-way ceramic distributor.
- Wall-mounted arm with adjustable stainless steel shower head: 300x300 mm.
- Wall-mounted support for hand shower with water supply.
- Anti-limescale brass hand shower.
- Satin hose.

Kit di miscelatore monocomando a incasso 2 getti Rapid-box per doccia

- Corpo a incasso incluso.
- Erogatore in ceramica a 2 getti.
- Braccio a muro con soffione doccia orientabile in acciaio inossidabile: 300x300 mm.
- Supporto per doccia con presa d'acqua a muro.
- Doccino anticalcare in ottone.
- Flessibile satinato.

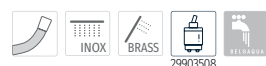

21128004	540,00
21128004NM	787,00
21128004BM	787,00
21128004AC	787,00
21128004KM	787,00
21128004KMB	787,00
21128004OR	1.081,00
21128004OM	1.081,00
21128004OP	1.081,00
21128004OPM	1.081,00

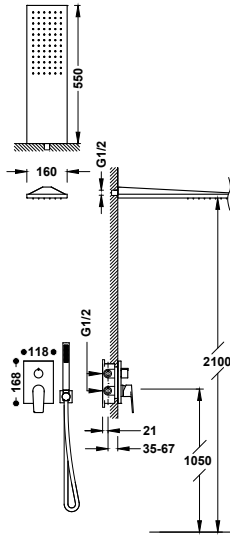

Rapid-box 2-way concealed single-handle shower mixer tap kit

- Concealed body included.
- 2-way ceramic distributor.
- Stainless steel wall-mounted shower head: 160x550 mm.
- Wall-mounted support for hand shower with water supply.
- Anti-limescale brass hand shower.
- Satin hose.

Kit di miscelatore monocomando a incasso 2 getti Rapid-box per doccia

- Corpo a incasso incluso.
- Erogatore in ceramica a 2 getti.
- Soffione doccia a muro in acciaio inossidabile: 160x550 mm.
- Supporto per doccia con presa d'acqua a muro.
- Doccino anticalcare in ottone.
- Flessibile satinato.

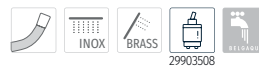

■ 21128005	731,00
■ 21128005NM	1.085,00
■ 21128005BM	1.085,00
■ 21128005AC	1.085,00
■ 21128005KM	1.085,00
■ 21128005KMB	1.085,00
■ 21128005OR	1.504,00
■ 21128005OM	1.504,00
■ 21128005OP	1.504,00
■ 21128005OPM	1.504,00

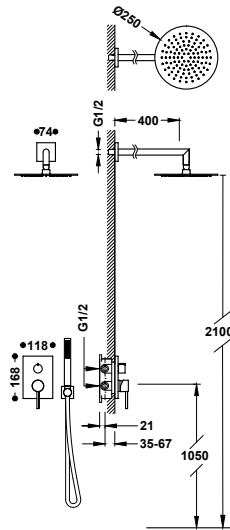

Rapid-box 2-way concealed single-handle shower mixer tap kit

- Concealed body included.
- 2-way ceramic distributor.
- Wall-mounted arm with adjustable stainless steel shower head: Ø 250 mm.
- Wall-mounted support for hand shower with water supply.
- Anti-limescale brass hand shower.
- Satin hose.

Kit di miscelatore monocomando a incasso 2 getti Rapid-box per doccia

- Corpo a incasso incluso.
- Erogatore in ceramica a 2 getti.
- Braccio a muro con soffione doccia orientabile in acciaio inossidabile: Ø 250 mm.
- Supporto per doccia con presa d'acqua a muro.
- Doccino anticalcare in ottone.
- Flessibile satinato.



■ 06228004	427,00
------------	--------

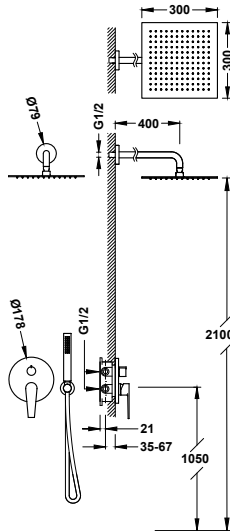

Rapid-box 2-way concealed single-handle shower mixer tap kit

- Concealed body included.
- 2-way ceramic distributor.
- Wall-mounted arm with adjustable stainless steel shower head: 300x300 mm.
- Wall-mounted support for hand shower with water supply.
- Anti-limescale hand shower.
- Satin hose.

Kit di miscelatore monocomando a incasso 2 getti Rapid-box per doccia

- Corpo a incasso incluso.
- Erogatore in ceramica a 2 getti.
- Braccio a muro con soffione doccia orientabile in acciaio inossidabile: 300x300 mm.
- Supporto per doccia con presa d'acqua a muro.
- Doccino anticalcare.
- Flessibile satinato.



■ 20528004	452,00
------------	--------

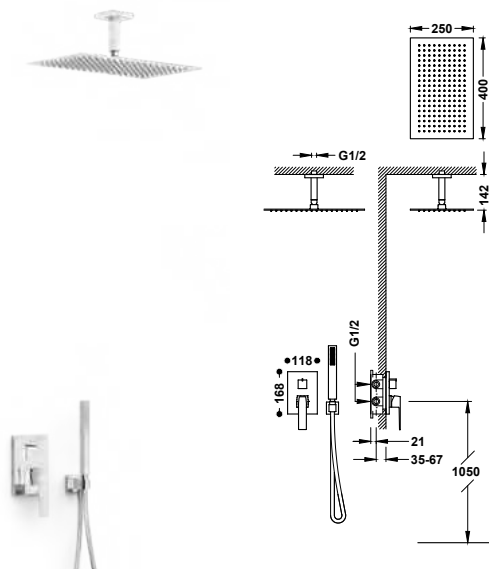

Rapid-box 2-way concealed single-handle shower mixer tap kit

- Concealed body included.
- 2-way ceramic distributor.
- Ceiling-mounted arm with adjustable stainless steel shower head: 400x250 mm.
- Wall-mounted support for hand shower with water supply.
- Anti-limescale brass hand shower.
- Satin hose.

Kit di miscelatore monocomando a incasso 2 getti Rapid-box per doccia

- Corpo a incasso incluso.
- Erogatore in ceramica a 2 getti.
- Braccio a soffitto con soffione doccia orientabile in acciaio inossidabile: 400x250 mm.
- Supporto per doccino con presa d'acqua a muro.
- Doccino anticalcare in ottone.
- Flessibile satinato.

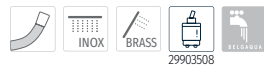

20228003	621,00
20228003NM	916,00
20228003BM	916,00
20228003AC	916,00
20228003OR	1.263,00
20228003OM	1.263,00

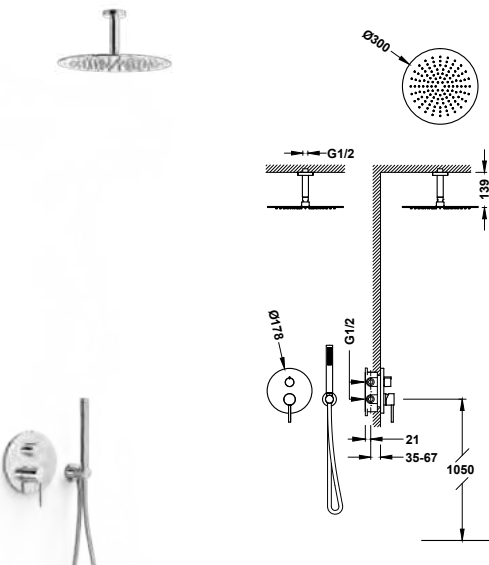

Rapid-box 2-way concealed single-handle shower mixer tap kit

- Concealed body included.
- 2-way ceramic distributor.
- Ceiling-mounted arm with adjustable stainless steel shower head: Ø 300 mm.
- Wall-mounted support for hand shower with water supply.
- Anti-limescale brass hand shower.
- Satin hose.

Kit di miscelatore monocomando a incasso 2 getti Rapid-box per doccia

- Corpo a incasso incluso.
- Erogatore in ceramica a 2 getti.
- Braccio a soffitto con soffione doccia orientabile in acciaio inossidabile: Ø 300 mm.
- Supporto per doccino con presa d'acqua a muro.
- Doccino anticalcare in ottone.
- Flessibile satinato.



26228003	473,00
26228003NM	675,00
26228003BM	675,00
26228003AC	675,00
26228003KM	675,00
26228003KMB	675,00
26228003OR	924,00
26228003OM	924,00
26228003OP	924,00
26228003OPM	924,00

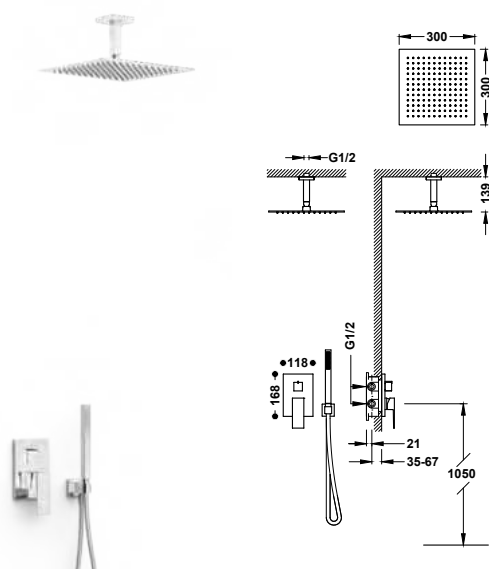

Rapid-box 2-way concealed single-handle shower mixer tap kit

- Concealed body included.
- 2-way ceramic distributor.
- Ceiling-mounted arm with adjustable stainless steel shower head: 300x300 mm.
- Wall-mounted support for hand shower with water supply.
- Anti-limescale brass hand shower.
- Satin hose.

Kit di miscelatore monocomando a incasso 2 getti Rapid-box per doccia

- Corpo a incasso incluso.
- Erogatore in ceramica a 2 getti.
- Braccio a soffitto con soffione doccia orientabile in acciaio inossidabile: 300x300 mm.
- Supporto per doccino con presa d'acqua a muro.
- Doccino anticalcare in ottone.
- Flessibile satinato.



00628003	559,00
00628003NM	818,00
00628003BM	818,00
00628003AC	818,00
00628003OR	1.125,00
00628003OM	1.125,00

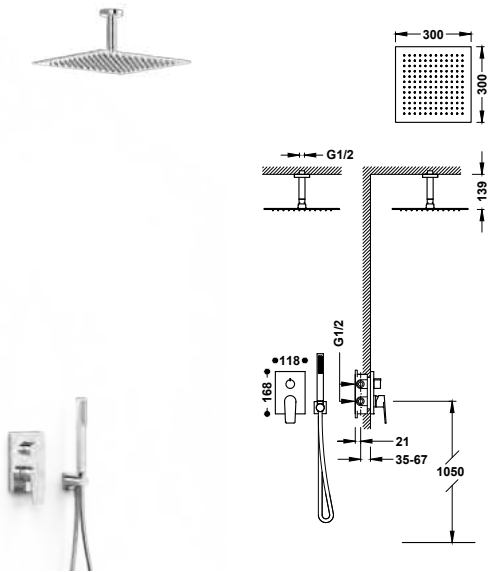

Rapid-box 2-way concealed single-handle shower mixer tap kit

- Concealed body included.
- 2-way ceramic distributor.
- Ceiling-mounted arm with adjustable stainless steel shower head: 300x300 mm.
- Wall-mounted support for hand shower with water supply.
- Anti-limescale brass hand shower.
- Satin hose.

Kit di miscelatore monocomando a incasso 2 getti Rapid-box per doccia

- Corpo a incasso incluso.
- Erogatore in ceramica a 2 getti.
- Braccio a soffitto con soffione doccia orientabile in acciaio inossidabile: 300x300 mm.
- Supporto per doccia con presa d'acqua a muro.
- Doccino anticalcare in ottone.
- Flessibile satinato.

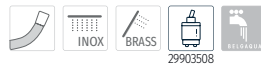

■ 21128003	506,00
■ 21128003NM	735,00
■ 21128003BM	735,00
■ 21128003AC	735,00
■ 21128003KM	735,00
■ 21128003KMB	735,00
■ 21128003OR	1.007,00
■ 21128003OM	1.007,00
■ 21128003OP	1.007,00
■ 21128003OPM	1.007,00

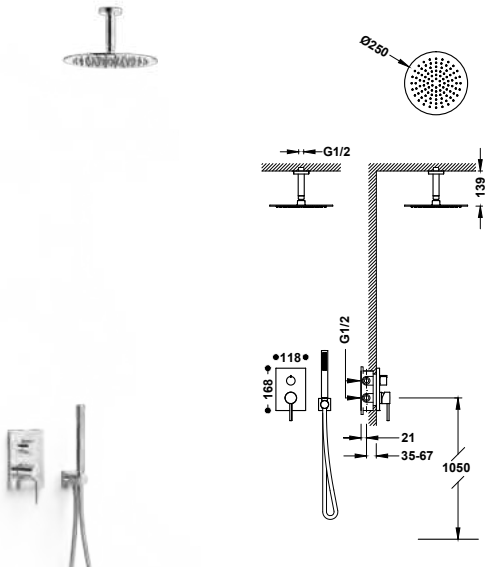

Rapid-box 2-way concealed single-handle shower mixer tap kit

- Concealed body included.
- 2-way ceramic distributor.
- Ceiling-mounted arm with adjustable stainless steel shower head: Ø 250 mm.
- Wall-mounted support for hand shower with water supply.
- Anti-limescale brass hand shower.
- Satin hose.

Kit di miscelatore monocomando a incasso 2 getti Rapid-box per doccia

- Corpo a incasso incluso.
- Erogatore in ceramica a 2 getti.
- Braccio a soffitto con soffione doccia orientabile in acciaio inossidabile: Ø 250 mm.
- Supporto per doccia con presa d'acqua a muro.
- Doccino anticalcare in ottone.
- Flessibile satinato.



■ 06228003	387,00
------------	--------

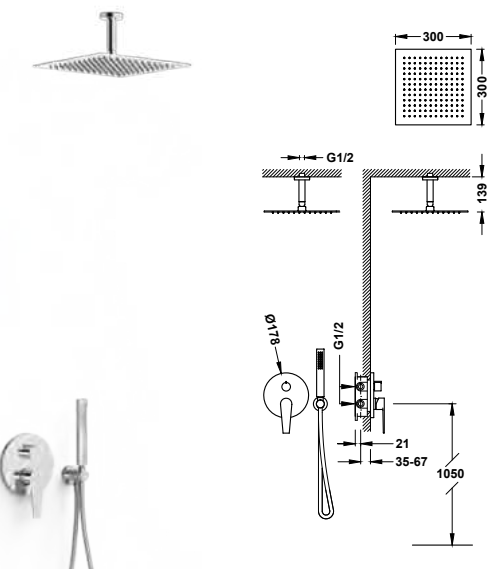

Rapid-box 2-way concealed single-handle shower mixer tap kit

- Concealed body included.
- 2-way ceramic distributor.
- Ceiling-mounted arm with adjustable stainless steel shower head: 300x300 mm.
- Wall-mounted support for hand shower with water supply.
- Anti-limescale hand shower.
- Satin hose.

Kit di miscelatore monocomando a incasso 2 getti Rapid-box per doccia

- Corpo a incasso incluso.
- Erogatore in ceramica a 2 getti.
- Braccio a soffitto con soffione doccia orientabile in acciaio inossidabile: 300x300 mm.
- Supporto per doccia con presa d'acqua a muro.
- Doccino anticalcare.
- Flessibile satinato.



■ 20528003	428,00
------------	--------

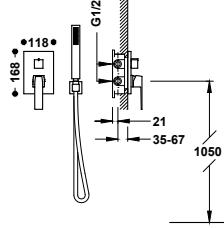
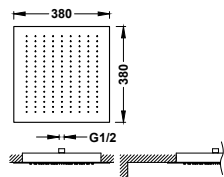

Rapid-box 2-way concealed single-handle shower mixer tap kit

- Concealed body included.
- 2-way ceramic distributor.
- Concealed stainless steel ceiling-mounted shower head: 380x380 mm.
- Wall-mounted support for hand shower with water supply.
- Anti-limescale brass hand shower.
- Satin hose.

Kit di miscelatore monocomando a incasso 2 getti Rapid-box per doccia

- Corpo a incasso incluso.
- Erogatore in ceramica a 2 getti.
- Soffione doccia soffitto a incasso in acciaio inossidabile: 380x380 mm.
- Supporto per doccia con presa d'acqua a muro.
- Doccino anticalcare in ottone.
- Flessibile satinato.

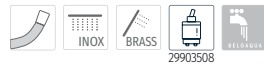

20228006	1.100,00
20228006NM	1.657,00
20228006BM	1.657,00
20228006AC	1.657,00
20228006OR	2.316,00
20228006OM	2.316,00

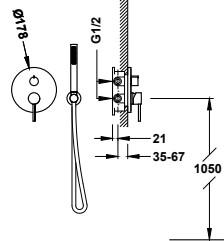
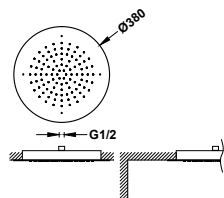

Rapid-box 2-way concealed single-handle shower mixer tap kit

- Concealed body included.
- 2-way ceramic distributor.
- Concealed stainless steel ceiling-mounted shower head: Ø 380 mm.
- Wall-mounted support for hand shower with water supply.
- Anti-limescale brass hand shower.
- Satin hose.

Kit di miscelatore monocomando a incasso 2 getti Rapid-box per doccia

- Corpo a incasso incluso.
- Erogatore in ceramica a 2 getti.
- Soffione doccia soffitto a incasso in acciaio inossidabile: Ø 380 mm.
- Supporto per doccia con presa d'acqua a muro.
- Doccino anticalcare in ottone.
- Flessibile satinato.



26228005	1.026,00
26228005NM	1.546,00
26228005BM	1.546,00
26228005AC	1.546,00
26228005KM	1.546,00
26228005KMB	1.546,00
26228005OR	2.160,00
26228005OM	2.160,00
26228005OP	2.160,00
26228005OPM	2.160,00

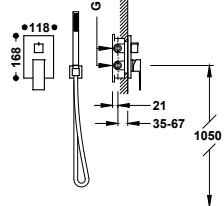
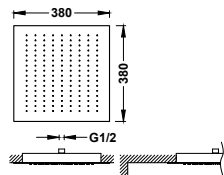

Rapid-box 2-way concealed single-handle shower mixer tap kit

- Concealed body included.
- 2-way ceramic distributor.
- Concealed stainless steel ceiling-mounted shower head: 380x380 mm.
- Wall-mounted support for hand shower with water supply.
- Anti-limescale brass hand shower.
- Satin hose.

Kit di miscelatore monocomando a incasso 2 getti Rapid-box per doccia

- Corpo a incasso incluso.
- Erogatore in ceramica a 2 getti.
- Soffione doccia soffitto a incasso in acciaio inossidabile: 380x380 mm.
- Supporto per doccia con presa d'acqua a muro.
- Doccino anticalcare in ottone.
- Flessibile satinato.



00628005	1.097,00
00628005NM	1.654,00
00628005BM	1.654,00
00628005AC	1.654,00
00628005OR	2.312,00
00628005OM	2.312,00

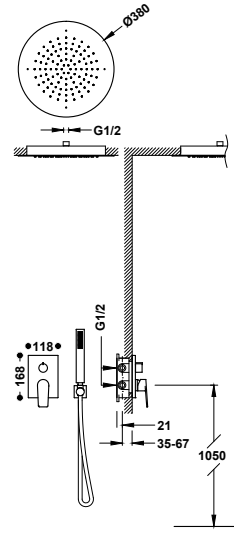









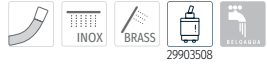



Rapid-box 2-way concealed single-handle shower mixer tap kit

- Concealed body included.
- 2-way ceramic distributor.
- Concealed stainless steel ceiling-mounted shower head: Ø 380 mm.
- Wall-mounted support for hand shower with water supply.
- Anti-limescale brass hand shower.
- Satin hose.

Kit di miscelatore monocomando a incasso 2 getti Rapid-box per doccia

- Corpo a incasso incluso.
- Erogatore in ceramica a 2 getti.
- Soffione doccia soffitto a incasso in acciaio inossidabile: Ø 380 mm.
- Supporto per doccia con presa d'acqua a muro.
- Doccino anticalcare in ottone.
- Flessibile satinato.



	21128006	1.086,00
	21128006NM	1.634,00
	21128006BM	1.634,00
	21128006AC	1.634,00
	21128006KM	1.634,00
	21128006KMB	1.634,00
	21128006OR	2.282,00
	21128006OM	2.282,00
	21128006OP	2.282,00
	21128006OPM	2.282,00

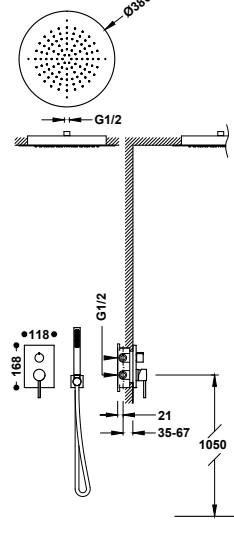



Rapid-box 2-way concealed single-handle shower mixer tap kit

- Concealed body included.
- 2-way ceramic distributor.
- Concealed stainless steel ceiling-mounted shower head: Ø 380 mm.
- Wall-mounted support for hand shower with water supply.
- Anti-limescale brass hand shower.
- Satin hose.

Kit di miscelatore monocomando a incasso 2 getti Rapid-box per doccia

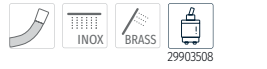
- Corpo a incasso incluso.
- Erogatore in ceramica a 2 getti.
- Soffione da soffitto a incasso in acciaio inossidabile: Ø 380 mm.
- Supporto per doccia con presa d'acqua a muro.
- Doccino anticalcare in ottone.
- Flessibile satinato.



	06228005	888,00
---	----------	--------

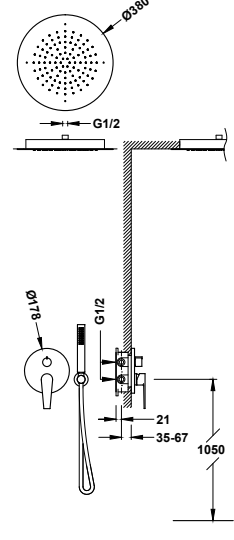



Rapid-box 2-way concealed single-handle shower mixer tap kit

- Concealed body included.
- 2-way ceramic distributor.
- Concealed stainless steel ceiling-mounted shower head: Ø 380 mm.
- Wall-mounted support for hand shower with water supply.
- Anti-limescale hand shower.
- Satin hose.

Kit di miscelatore monocomando a incasso 2 getti Rapid-box per doccia

- Corpo a incasso incluso.
- Erogatore in ceramica a 2 getti.
- Soffione doccia soffitto a incasso in acciaio inossidabile: Ø 380 mm.
- Supporto per doccia con presa d'acqua a muro.
- Doccino anticalcare.
- Flessibile satinato.



	20528005	905,00
---	----------	--------

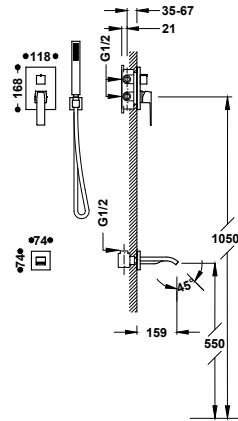

Rapid-box 2-way concealed single-handle mixer tap kit for bath and shower

- Concealed body included.
- 2-way ceramic distributor.
- Fixed wall-mounted spout.
- Wall-mounted support for hand shower with water supply.
- Anti-limescale brass hand shower.
- Satin hose.

Kit di miscelatore monocomando a incasso a 2 getti Rapid-box per vasca e doccia

- Corpo a incasso incluso.
- Erogatore in ceramica a 2 getti.
- Canna fissa a muro.
- Supporto per doccino con presa d'acqua a muro.
- Doccino anticalcare in ottone.
- Flessibile satinato.

20228007	462,00
20228007NM	651,00
20228007BM	651,00
20228007AC	651,00
20228007OR	907,00
20228007OM	907,00

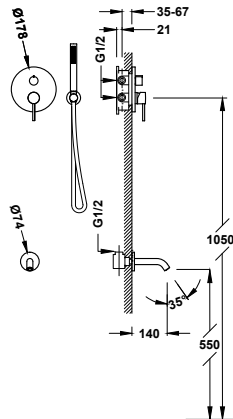
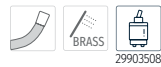

Rapid-box 2-way concealed single-handle mixer tap kit for bath and shower

- Concealed body included.
- 2-way ceramic distributor.
- Fixed wall-mounted spout.
- Wall-mounted support for hand shower with water supply.
- Anti-limescale brass hand shower.
- Satin hose.

Kit di miscelatore monocomando a incasso a 2 getti Rapid-box per vasca e doccia

- Corpo a incasso incluso.
- Erogatore in ceramica a 2 getti.
- Canna fissa a muro.
- Supporto per doccino con presa d'acqua a muro.
- Doccino anticalcare in ottone.
- Flessibile satinato.

26228006	381,00
26228006NM	545,00
26228006BM	545,00
26228006AC	545,00
26228006KM	545,00
26228006KMB	545,00
26228006OR	740,00
26228006OM	740,00
26228006OP	740,00
26228006OPM	740,00

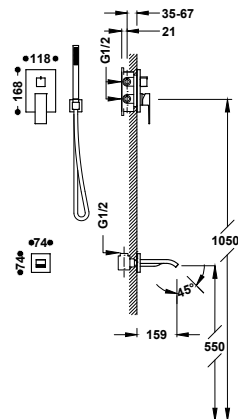

Rapid-box 2-way concealed single-handle mixer tap kit for bath and shower

- Concealed body included.
- 2-way ceramic distributor.
- Fixed wall-mounted spout.
- Wall-mounted support for hand shower with water supply.
- Anti-limescale brass hand shower.
- Satin hose.

Kit di miscelatore monocomando a incasso a 2 getti Rapid-box per vasca e doccia

- Corpo a incasso incluso.
- Erogatore in ceramica a 2 getti.
- Canna fissa a muro.
- Supporto per doccino con presa d'acqua a muro.
- Doccino anticalcare in ottone.
- Flessibile satinato.

00628006	459,00
00628006NM	662,00
00628006BM	662,00
00628006AC	662,00
00628006OR	903,00
00628006OM	903,00

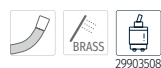

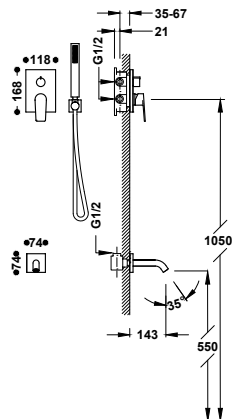

Rapid-box 2-way concealed single-handle mixer tap kit for bath and shower

- Concealed body included.
- 2-way ceramic distributor.
- Fixed wall-mounted spout.
- Wall-mounted support for hand shower with water supply.
- Anti-limescale brass hand shower.
- Satin hose.

Kit di miscelatore monocomando a incasso a 2 getti Rapid-box per vasca e doccia

- Corpo a incasso incluso.
- Erogatore in ceramica a 2 getti.
- Canna fissa a muro.
- Supporto per doccia con presa d'acqua a muro.
- Doccino anticalcare in ottone.
- Flessibile satinato.

21128007	394,00
21128007NM	560,00
21128007BM	560,00
21128007AC	560,00
21128007KM	560,00
21128007KMB	560,00
21128007OR	758,00
21128007OM	758,00
21128007OP	758,00
21128007OPM	758,00

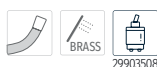

29903508

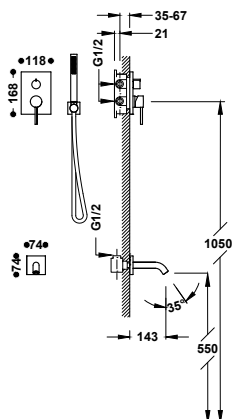

Rapid-box 2-way concealed single-handle mixer tap kit for bath and shower

- Concealed body included.
- 2-way ceramic distributor.
- Fixed wall-mounted spout.
- Wall-mounted support for hand shower with water supply.
- Anti-limescale brass hand shower.
- Satin hose.

Kit di miscelatore monocomando a incasso a 2 getti Rapid-box per vasca e doccia

- Corpo a incasso incluso.
- Erogatore in ceramica a 2 getti.
- Canna fissa a muro.
- Supporto per doccia con presa d'acqua a muro.
- Doccino anticalcare in ottone.
- Flessibile satinato.

06228006	335,00
----------	--------

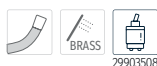

29903508

3-WAY KITS / KIT A 3 GETTI

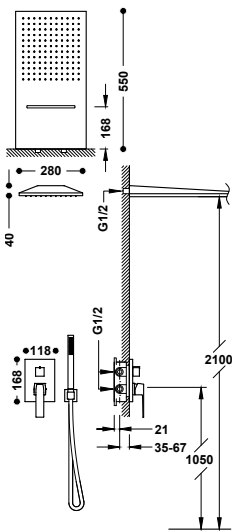

Rapid-box 3-way concealed single-handle shower mixer tap kit

- Concealed body included.
- 3-way ceramic distributor.
- Stainless steel wall-mounted shower head with 2 stream types (rain/cascade). 280x550 mm. IMPORTANT: Install a >50 l/min drain.
- Wall-mounted support for hand shower with water supply.
- Anti-limescale brass hand shower.
- Satin hose.

Kit di miscelatore monocomando a incasso 3 getti Rapid-box per doccia

- Corpo a incasso incluso.
- Erogatore in ceramica a 3 getti.
- Soffione doccia a muro in acciaio inossidabile con 2 tipi di getto (pioggia/cascata). 280x550 mm. IMPORTANTE: Montare uno scarico da >50 l/min.
- Supporto per doccia con presa d'acqua a muro.
- Doccino anticalcare in ottone.
- Flessibile satinato.

20227301	1.076,00
20227301NM	1.618,00
20227301BM	1.618,00
20227301AC	1.618,00
20227301KMB	1.618,00
20227301OR	2.258,00
20227301OM	2.258,00



29903508

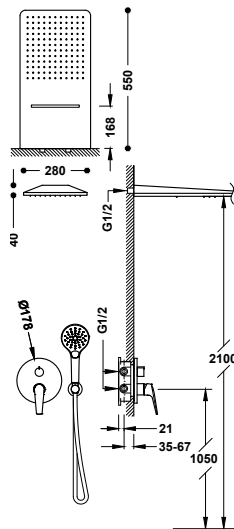

Rapid-box 3-way concealed single-handle shower mixer tap kit

- Concealed body included.
- 3-way ceramic distributor.
- Stainless steel wall-mounted shower head with 2 stream types (rain/cascade). 280x550 mm. IMPORTANT: Install a >50 l/min drain.
- Wall-mounted support for hand shower with water supply.
- Anti-limescale hand showers: Ø 110 mm. (3 stream types).
- Satin hose.

28127301	1.104,00
28127301NM	1.660,00
28127301AC	1.660,00
28127301OPM	2.318,00

Kit di miscelatore monocomando a incasso 3 getti Rapid-box per doccia

- Corpo a incasso incluso.
- Erogatore in ceramica a 3 getti.
- Soffione doccia a muro in acciaio inossidabile con 2 tipi di getto (pioggia/cascata). 280x550 mm. IMPORTANTE: Montare uno scarico da >50 l/min.
- Supporto per doccino con presa d'acqua a muro.
- Doccino anticalcare: Ø 110 mm. (3 tipi di getto).
- Flessibile satinato.

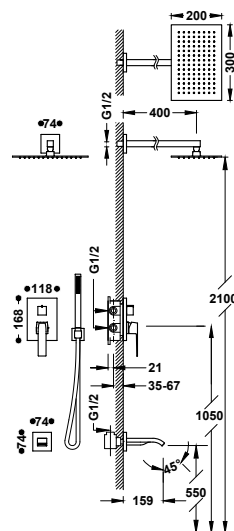

Rapid-box 3-way concealed single-handle shower mixer tap kit

- Concealed body included.
- 3-way ceramic distributor.
- Wall-mounted arm with adjustable stainless steel shower head: 300x200 mm.
- Fixed wall-mounted spout.
- Wall-mounted support for hand shower with water supply.
- Anti-limescale brass hand shower.
- Satin hose.

20227303	786,00
20227303NM	1.203,00
20227303BM	1.203,00
20227303AC	1.203,00
20227303OR	1.618,00
20227303OM	1.618,00

Kit di miscelatore monocomando a incasso 3 getti Rapid-box per doccia

- Corpo a incasso incluso.
- Erogatore in ceramica a 3 getti.
- Braccio a muro con soffione doccia orientabile in acciaio inossidabile: 300x200 mm.
- Canna fissa a muro.
- Supporto per doccino con presa d'acqua a muro.
- Doccino anticalcare in ottone.
- Flessibile satinato.

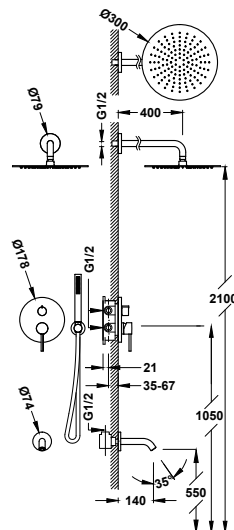

Rapid-box 3-way concealed single-handle shower mixer tap kit

- Concealed body included.
- 3-way ceramic distributor.
- Wall-mounted arm with adjustable stainless steel shower head: Ø 300 mm.
- Fixed wall-mounted spout.
- Wall-mounted support for hand shower with water supply.
- Anti-limescale brass hand shower.
- Satin hose.

26227302	663,00
26227302NM	946,00
26227302BM	946,00
26227302AC	946,00
26227302KM	946,00
26227302KMB	946,00
26227302OR	1.304,00
26227302OP	1.304,00
26227302OM	1.304,00
26227302OPM	1.304,00

Kit di miscelatore monocomando a incasso 3 getti Rapid-box per doccia

- Corpo a incasso incluso.
- Erogatore in ceramica a 3 getti.
- Braccio a muro con soffione doccia orientabile in acciaio inossidabile: Ø 300 mm.
- Canna fissa a muro.
- Supporto per doccino con presa d'acqua a muro.
- Doccino anticalcare in ottone.
- Flessibile satinato.



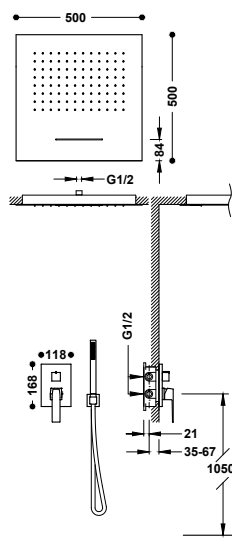

Rapid-box 3-way concealed single-handle shower mixer tap kit

- Concealed body included.
- 3-way ceramic distributor.
- Stainless steel concealed ceiling-mounted shower head with 2 stream types (rain/cascade). 500x500 mm. IMPORTANT: Install a >50 l/min drain.
- Wall-mounted support for hand shower with water supply.
- Anti-limescale brass hand shower.
- Satin hose.

Kit di miscelatore monocomando a incasso 3 getti Rapid-box per doccia

- Corpo a incasso incluso.
- Erogatore in ceramica a 3 getti.
- Soffione doccia a incasso da soffitto in acciaio inossidabile con 2 tipi di getto (pioggia/cascata). 500x500 mm. IMPORTANTE: Montare uno scarico da >50 l/min.
- Supporto per doccia con presa d'acqua a muro.
- Doccino anticalcare in ottone.
- Flessibile satinato.



20227302	1.445,00
20227302NM	2.189,00
20227302BM	2.189,00
20227302AC	2.189,00
20227302KMB	2.189,00
20227302OR	3.069,00
20227302OM	3.069,00

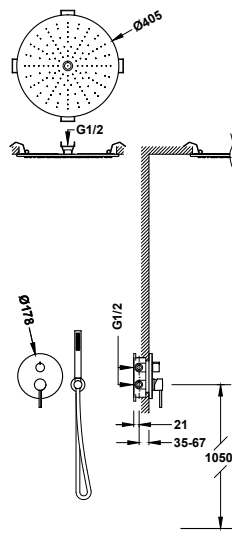

Rapid-box 3-way concealed single-handle shower mixer tap kit

- Concealed body included.
- 3-way ceramic distributor.
- Stainless steel concealed ceiling-mounted shower head with 2 stream types (rain/free flow). Ø 405 mm.
- Wall-mounted support for hand shower with water supply.
- Anti-limescale brass hand shower.
- Satin hose.

Kit di miscelatore monocomando a incasso 3 getti Rapid-box per doccia

- Corpo a incasso incluso.
- Erogatore in ceramica a 3 getti.
- Soffione doccia a incasso da soffitto in acciaio inossidabile con 2 tipi di getto (pioggia/free flow). Ø 405 mm.
- Supporto per doccia con presa d'acqua a muro.
- Doccino anticalcare in ottone.
- Flessibile satinato.



26227301	1.164,00
26227301NM	1.754,00
26227301BM	1.754,00
26227301AC	1.754,00
26227301KM	1.754,00
26227301KMB	1.754,00
26227301OR	2.450,00
26227301OP	2.450,00
26227301OM	2.450,00
26227301OPM	2.450,00

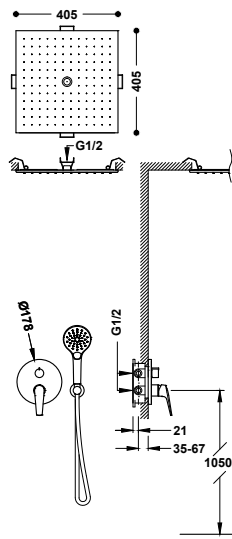

Rapid-box 3-way concealed single-handle shower mixer tap kit

- Concealed body included.
- 3-way ceramic distributor.
- Stainless steel concealed ceiling-mounted shower head with 2 stream types (rain/free flow). 405x405 mm.
- Wall-mounted support for hand shower with water supply.
- Anti-limescale hand showers: Ø 110 mm. (3 stream types).
- Satin hose.

Kit di miscelatore monocomando a incasso 3 getti Rapid-box per doccia

- Corpo a incasso incluso.
- Erogatore in ceramica a 3 getti.
- Soffione doccia a incasso da soffitto in acciaio inossidabile con 2 tipi di getto (pioggia/free flow). 405x405 mm.
- Supporto per doccia con presa d'acqua a muro.
- Doccino anticalcare: Ø 110 mm. (3 tipi di getto).
- Flessibile satinato.



28127302	1.180,00
28127302NM	1.780,00
28127302AC	1.780,00
28127302OPM	2.486,00





SURFACE-MOUNTED SINGLE-LEVER MIXERS MISCELATORI MONOCOMANDO DA APPOGGIO

Shower mixer taps are a simple solution, easy to install, with different designs and shapes to suit any space. They stand out for their practicality: comfortable handling with a single control, and high resistance to the passage of time.

I miscelatori monocomando per la doccia sono una soluzione semplice e facile da installare con diversi design e forme che si adattano a qualsiasi spazio. Spiccano per la loro funzionalità, un utilizzo comodo mediante un unico comando e un'elevata resistenza nel tempo.





MIXER TAP SETS FOR SHOWER / SET MONOCOMANDO PER DOCCIA

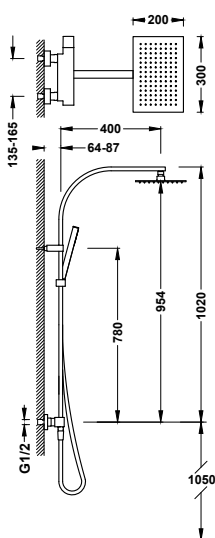

2-way wall-fitted single-handle shower mixer tap

- Stainless steel adjustable shower head: 300x200 mm.
- Adjustable and sliding support for hand shower.
- Anti-limescale brass hand shower.
- Satin hose.

Set miscelatore monocomando a muro 2 getti per doccia

- Soffione doccia orientabile in acciaio inossidabile: 300x200 mm.
- Supporto scorrevole e orientabile per doccia.
- Doccino anticalcare in ottone.
- Flessibile satinato.

	20219101	715,00
	20219101NM	1.108,00
	20219101BM	1.108,00
	20219101AC	1.108,00
	20219101KMB	1.108,00

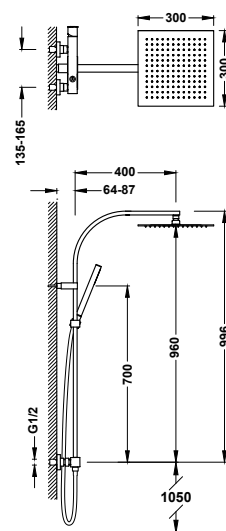
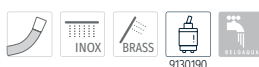

2-way wall-fitted single-handle shower mixer tap

- Stainless steel adjustable shower head: 300x300 mm.
- Adjustable and sliding support for hand shower.
- Anti-limescale brass hand shower.
- Satin hose.

Set miscelatore monocomando a muro 2 getti per doccia

- Soffione doccia orientabile in acciaio inossidabile: 300x300 mm.
- Supporto scorrevole e orientabile per doccia.
- Doccino anticalcare in ottone.
- Flessibile satinato.

	00719102	680,00
--	----------	--------

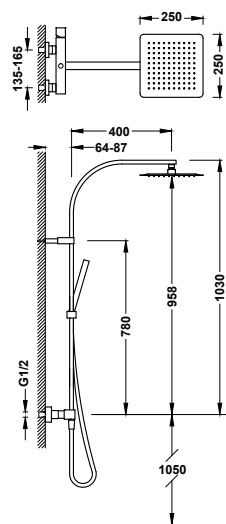

2-way wall-fitted single-handle shower mixer tap

- Stainless steel adjustable shower head: 250x250 mm.
- Adjustable and sliding support for hand shower.
- Anti-limescale brass hand shower.
- Satin hose.

Set miscelatore monocomando a muro 2 getti per doccia

- Soffione doccia orientabile in acciaio inossidabile: 250x250 mm.
- Supporto scorrevole e orientabile per doccia.
- Doccino anticalcare in ottone.
- Flessibile satinato.

	00719101	635,00
--	----------	--------



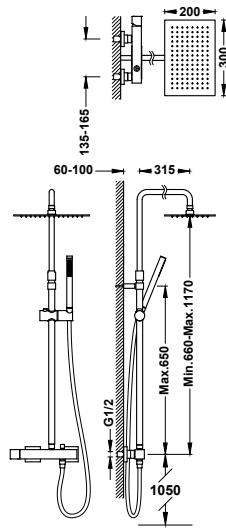

2-way wall-fitted single-handle shower mixer tap

00719702

626,00

- Stainless steel adjustable shower head: 300x200 mm.
- Telescopic shower bar.
- Adjustable and sliding support for hand shower.
- Anti-limescale brass hand shower.
- Satin hose.

Set miscelatore monocomando a muro 2 getti per doccia

- Soffione doccia orientabile in acciaio inossidabile: 300x200 mm.
- Colonna doccia telescopica.
- Supporto scorrevole e orientabile per doccino.
- Doccino anticalcare in ottone.
- Flessibile satinato.

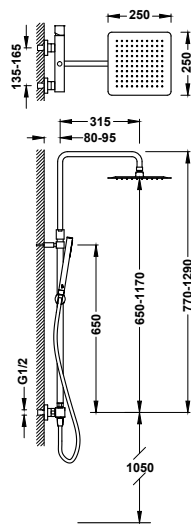

2-way wall-fitted single-handle shower mixer tap

00719701

582,00

- Stainless steel adjustable shower head: 250x250 mm.
- Telescopic shower bar.
- Adjustable and sliding support for hand shower.
- Anti-limescale brass hand shower.
- Satin hose.

Set miscelatore monocomando a muro 2 getti per doccia

- Soffione doccia orientabile in acciaio inossidabile: 250x250 mm.
- Colonna doccia telescopica.
- Supporto scorrevole e orientabile per doccino.
- Doccino anticalcare in ottone.
- Flessibile satinato.

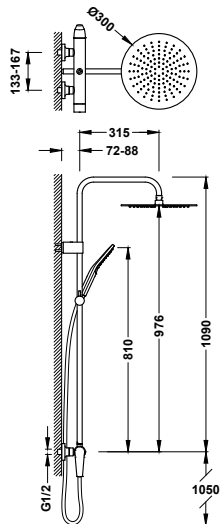

2-way wall-fitted single-handle shower mixer tap

28119101

497,00

- With diverter integrated.
- Stainless steel adjustable shower head: Ø 300 mm.
- Adjustable and sliding support for hand shower.
- Anti-limescale hand showers: Ø 110 mm. (3 stream types).
- Satin hose.

28119101NM

770,00

28119101AC

770,00

281191010PM

1.093,00

Set miscelatore monocomando a muro 2 getti per doccia

- Con inverter incorporato.
- Soffione doccia orientabile in acciaio inossidabile: Ø 300 mm.
- Supporto scorrevole e orientabile per doccino.
- Doccino anticalcare: Ø 110 mm. (3 tipi di getto).
- Flessibile satinato.



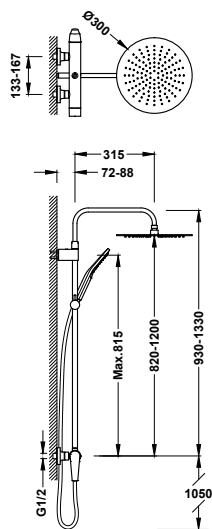





2-way wall-fitted single-handle shower mixer tap

- With diverter integrated.
- Stainless steel adjustable shower head: \varnothing 300 mm.
- Telescopic shower bar.
- Adjustable and sliding support for hand shower.
- Anti-limescale hand showers: \varnothing 110 mm. (3 stream types).
- Satin hose.

Set miscelatore monocomando a muro 2 getti per doccia

- Con inverter incorporato.
- Soffione doccia orientabile in acciaio inossidabile: \varnothing 300 mm.
- Colonna doccia telescopica.
- Supporto scorrevole e orientabile per doccino.
- Doccino anticalcare: \varnothing 110 mm. (3 tipi di getto).
- Flessibile satinato.

	28119701	528,00
	28119701NM	819,00
	28119701AC	819,00
	28119701OPM	1.162,00

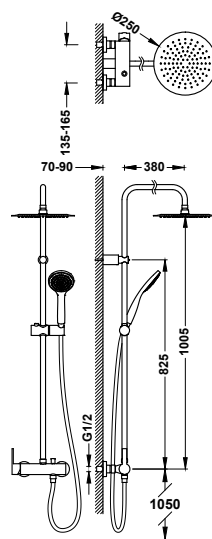

2-way wall-fitted single-handle shower mixer tap

- Stainless steel adjustable shower head: \varnothing 250 mm.
- Adjustable and sliding support for hand shower.
- Anti-limescale hand showers: \varnothing 100 mm.
- Satin hose.

Set miscelatore monocomando a muro 2 getti per doccia

- Soffione doccia orientabile in acciaio inossidabile: \varnothing 250 mm.
- Supporto scorrevole e orientabile per doccino.
- Doccino anticalcare: \varnothing 100 mm.
- Flessibile satinato.

	18119102	412,00
---	----------	--------

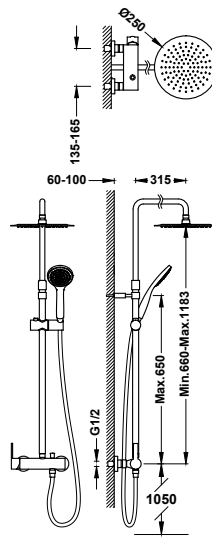

2-way wall-fitted single-handle shower mixer tap

- Stainless steel adjustable shower head: \varnothing 250 mm.
- Telescopic shower bar.
- Adjustable and sliding support for hand shower.
- Anti-limescale hand showers: \varnothing 100 mm.
- Satin hose.

Set miscelatore monocomando a muro 2 getti per doccia

- Soffione doccia orientabile in acciaio inossidabile: \varnothing 250 mm.
- Colonna doccia telescopica.
- Supporto scorrevole e orientabile per doccino.
- Doccino anticalcare: \varnothing 100 mm.
- Flessibile satinato.

	08119703	470,00
---	----------	--------



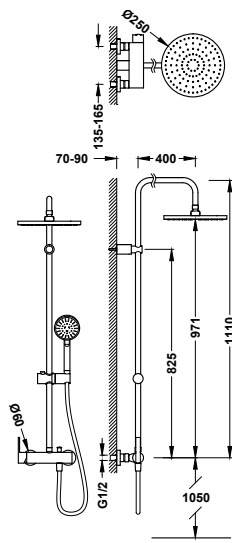

2-way wall-fitted single-handle shower mixer tap

181191

412,00

- Stainless steel adjustable shower head: Ø 250 mm.
- Adjustable and sliding support for hand shower.
- Anti-limescale hand showers: Ø 100 mm. (5 stream types).
- Satin hose.

Set miscelatore monocomando a muro 2 getti per doccia

- Soffione doccia orientabile in acciaio inossidabile: Ø 250 mm.
- Supporto scorrevole e orientabile per doccino.
- Doccino anticalcare: Ø 100 mm. (5 tipi di getto).
- Flessibile satinato.

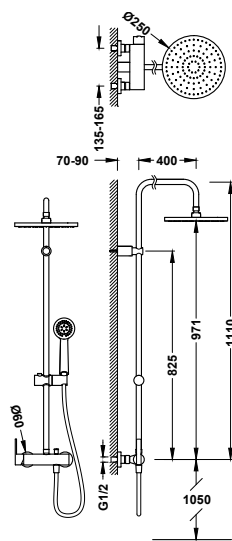

2-way wall-fitted single-handle shower mixer tap

081192

399,00

- Stainless steel adjustable shower head: Ø 250 mm.
- Adjustable and sliding support for hand shower.
- Anti-limescale hand showers: Ø 100 mm.
- Reinforced metal hose.

Set miscelatore monocomando a muro 2 getti per doccia

- Soffione doccia orientabile in acciaio inossidabile: Ø 250 mm.
- Supporto scorrevole e orientabile per doccino.
- Doccino anticalcare: Ø 100 mm.
- Flessibile rinforzato in metallo.

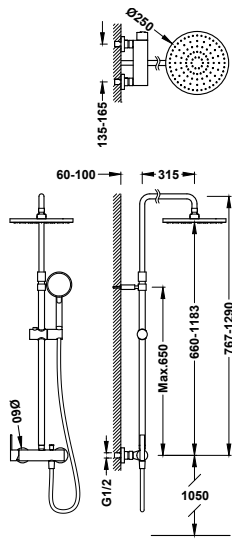

2-way wall-fitted single-handle shower mixer tap

08119702

475,00

- Stainless steel adjustable shower head: Ø 250 mm.
- Telescopic shower bar.
- Adjustable and sliding support for hand shower.
- Anti-limescale hand showers: Ø 100 mm. (5 stream types).
- Satin hose.

Set miscelatore monocomando a muro 2 getti per doccia

- Soffione doccia orientabile in acciaio inossidabile: Ø 250 mm.
- Colonna doccia telescopica.
- Supporto scorrevole e orientabile per doccino.
- Doccino anticalcare: Ø 100 mm. (5 tipi di getto).
- Flessibile satinato.



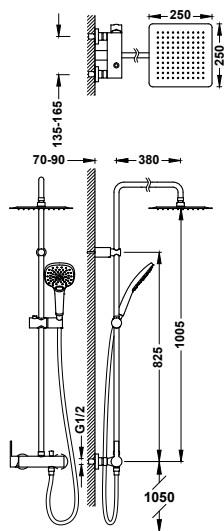

2-way wall-fitted single-handle shower mixer tap

08119302

433,00

- Stainless steel adjustable shower head: 250x250 mm.
- Adjustable and sliding support for hand shower.
- Anti-limescale hand showers: 120x120 mm. (3 stream types).
- Satin hose.

Set miscelatore monocomando a muro 2 getti per doccia

- *Soffione doccia orientabile in acciaio inossidabile: 250x250 mm.*
- *Supporto scorrevole e orientabile per doccia.*
- *Doccino anticalcare: 120x120 mm. (3 tipi di getto).*
- *Flessibile satinato.*

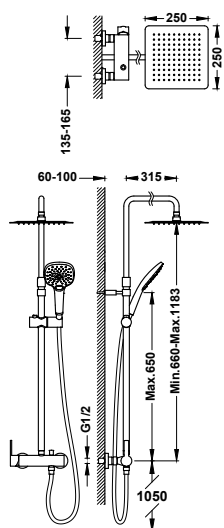

2-way wall-fitted single-handle shower mixer tap

08119704

497,00

- Stainless steel adjustable shower head: 250x250 mm.
- Telescopic shower bar.
- Adjustable and sliding support for hand shower.
- Anti-limescale hand showers: 120x120 mm. (3 stream types).
- Satin hose.

Set miscelatore monocomando a muro 2 getti per doccia

- *Soffione doccia orientabile in acciaio inossidabile: 250x250 mm.*
- *Colonna doccia telescopica.*
- *Supporto scorrevole e orientabile per doccia.*
- *Doccino anticalcare: 120x120 mm. (3 tipi di getto).*
- *Flessibile satinato.*

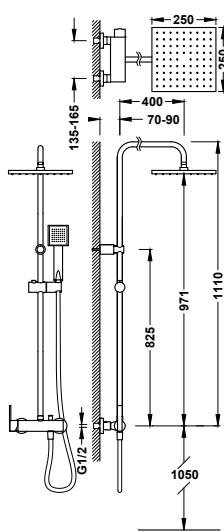

2-way wall-fitted single-handle shower mixer tap

08119301

425,00

- Stainless steel adjustable shower head: 250x250 mm.
- Adjustable and sliding support for hand shower.
- Anti-limescale hand showers: 80x80 mm.
- Satin hose.

Set miscelatore monocomando a muro 2 getti per doccia

- *Soffione doccia orientabile in acciaio inossidabile: 250x250 mm.*
- *Supporto scorrevole e orientabile per doccia.*
- *Doccino anticalcare: 80x80 mm.*
- *Flessibile satinato.*



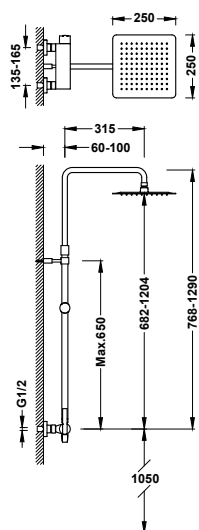

2-way wall-fitted single-handle shower mixer tap

08119701

451,00

- Stainless steel adjustable shower head: 250x250 mm.
- Telescopic shower bar.
- Adjustable and sliding support for hand shower.
- Anti-limescale hand showers.
- Satin hose.

Set miscelatore monocomando a muro 2 getti per doccia

- Soffione doccia orientabile in acciaio inossidabile: 250x250 mm.
- Colonna doccia telescopica.
- Supporto scorrevole e orientabile per doccia.
- Doccino anticalcare.
- Flessibile satinato.



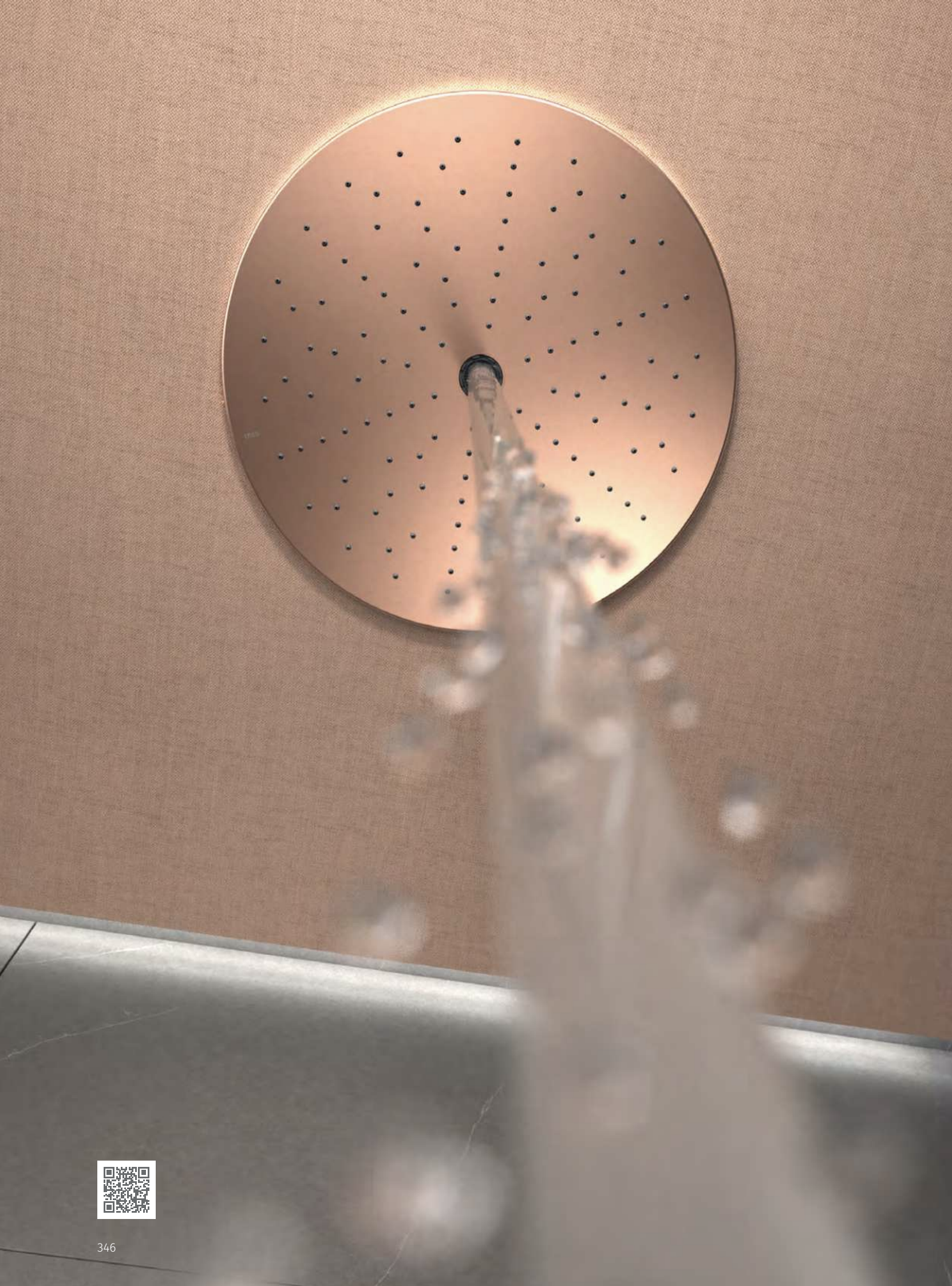



















































































SHOWER COMPLEMENTS

COMPLEMENTI PER DOCCIA























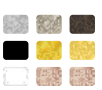













- 354 Concealed ceiling shower heads
Soffioni da soffitto a incasso
- 357 Ceiling shower heads
Soffioni da soffitto
- 358 Wall shower heads
Soffioni a muro
- 361 Shower heads and arms
Soffioni e bracci
- 371 Hand showers
Doccini
- 377 Flexible hoses
Flessibili
- 380 Sliding bars
Barre scorrevoli
- 390 Shower kits
Kit per doccia
- 394 Steerable supports
Supporti orientabili
- 395 Supports with wall connection
Supporto con presa a muro
- 397 Wall elbow adaptors
Adattatore a gomito a muro
- 398 Jets
Getti































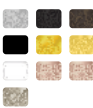











Reference Riferimento	Page Pagina	Available finishes Finiture disponibili	Concealed Incastrati nel soffitto	Wall-mounted A muro	Ceiling-mounted A soffitto	Manufacturing material Materiale di fabbricazione	Dimensions Dimensioni	Water outlets Uscite dell'acqua					l/min
 29997001	→354		✓			 INOX	500 x 650	2	18.5	16			
 29997201	→354	 	✓			 INOX	500 x 650	2	18.5	16			
 29997101	→354		✓			 INOX	500 x 650	3	18.5	16	8		
 29996201	→354	 	✓			 INOX	500 x 500	1	14				
 29995501	→354		✓			 INOX	500 x 500	2	20	16			
 134951	→355		✓			 INOX	500 x 500	1	24				
 13495102	→355		✓			 INOX	405 x 405	1	15				
 13495101	→355		✓			 INOX	405 x 405	1	15				
 29951607	→355		✓			 INOX	420 x 420	1	20				
 29995301	→355		✓			 INOX	380 x 380	1	20				
 134944	→356		✓			 INOX	380 x 380	1	20				
 134714	→356		✓			 BRASS	332 x 332	1	11				











































	Reference Riferimento	Page Pagina	Available finishes Finiture disponibili	Concealed Incassati nel soffitto	Wall-mounted A muro	Ceiling-mounted A soffitto	Manufacturing material Materiale di fabbricazione	Dimensions Dimensioni	Water outlets Uscite dell'acqua					L/min
	29995801 	→356		✓				600	2	20			8	
	134950	→356		✓				500	1	24				
	13495002	→356		✓				405	1	15				
	13495001	→357		✓				405	1	15				
	134940	→357		✓				380	1	20				
	134715	→357		✓				332	1	11				
	29990301	→358			✓			280 x 550	2	12	14			
	29990302	→359			✓			210 x 550	1	12.5				
	29990303	→359			✓			160 x 550	1	12.5				
	29990308	→359			✓			280 x 550	2	12	14			
	29990307	→359			✓			210 x 550	1	12.5				
	29990306	→359			✓			160 x 550	1	12.5				











































	Reference Riferimento	Page Pagina	Available finishes Finiture disponibili	Concealed Incasati nel soffitto	Wall-mounted A muro	Ceiling-mounted A soffitto	Manufacturing material Materiale di fabbricazione	Dimensions Dimensioni	Water outlets Uscite dell'acqua					l/min
	29990304	→360			✓			154 x 200	1		16			
	29963203	→361			✓	✓		450 x 315	1	14				
	134315008	→361			✓	✓		400 x 250	1	16				
	134315007	→362			✓	✓		300 x 200	1	12				
	134315014	→362			✓	✓		400 x 400	1	15				
	134315012	→362			✓	✓		300 x 300	1	12				
	13431830	→362			✓	✓		300 x 300	1	11				
	134315011	→362			✓	✓		250 x 250	1	12				
	13431826	→363			✓	✓		250 x 250	1	11				
	134315006	→363			✓	✓		300 x 300	1	12				
	134315004	→363			✓	✓		250 x 250	1	12				
	134315002	→363			✓	✓		200 x 200	1	12				

	Reference Riferimento	Page Pagina	Available finishes Finiture disponibili	Concealed Incaassati nel soffitto	Wall-mounted A muro	Ceiling-mounted A soffitto	Manufacturing material Materiale di fabbricazione	Dimensions Dimensioni	Water outlets Uscite dell'acqua					L/min
	29963206	→363			✓	✓		220 x 220	1	15				
	29943801	→364			✓	✓		242 x 242	1	12				
	134315015	→364			✓	✓		400	1	15				
	29933703	→364			✓	✓		310	1	11				
	134315010	→364			✓	✓		300	1	12				
	13413730	→364			✓	✓		300	1	11				
	134315005	→365			✓	✓		300	1	12				
	134315003	→365			✓	✓		250	1	12				
	134315009	→365			✓	✓		250	1	12				
	13413726	→365			✓	✓		250	1	11				
	13431513	→366			✓	✓		225	1	12				
	134315001	→365			✓	✓		200	1	12				



	Reference Riferimento	Page Pagina	Available finishes Finiture disponibili	Manufacturing material Materiale di fabbricazione	Dimensions Dimensioni	Number of functions Numero di funzioni							l/min
	00663901	→371				1	9.5						
	03411601	→371				1	9.5						
	913412380	→371				1	12						
	03463901	→371				1	13						
	29963108	→371				1	12						
	134748	→372			100	5	16	16.5	15.5	16	11		
	29974904	→372			130	3	7	8	5				
	29963113	→372			96 x 110	3	8.5	8+AIR	2				
	29963112	→372			110	3	8.5	8+AIR	2				
	29974906	→372			107 x 107	3	8.2	8.6	8.1				
	29974905	→373			110	3	8.8	9.6	8.8				
	29974901	→373			110	5	10	12.5	12	12.5	10		

	Reference Riferimento	Page Pagina	Available finishes Finiture disponibili	Manufacturing material Materiale di fabbricazione	Dimensions Dimensioni	Number of functions Numero di funzioni							
	29963111	→373		 ABS	120 x 120	3	10	14	9				
	29963115	→373		 ABS	110	5	17	17	11	17	10		
	29963106	→374		 ABS	110	5	10	10	8.5		8.5	9.5	
	134627	→374		 ABS	80	2	15				7		
	29963114	→374		 ABS	100	3	14	14	10				
	29963109	→374		 BRASS	78	1	10						
	29974802	→374		 ABS	100	1	9.5						
	29963105	→375		 ABS	110	1	10						
	134612	→375		 ABS	80 x 80	1	15						
	29963110	→375		 ABS	100	1	16						
	134617	→375		 ABS	80	1	15.5						
	9134725	→375		 ABS	77	1	7.5						



CONCEALED CEILING SHOWER HEADS / SOFFIONI DA SOFFITTO A INCASSO

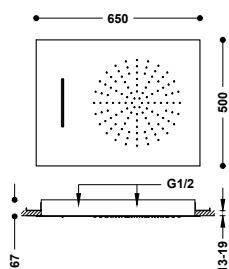
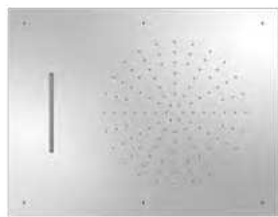

Concealed ceiling-mounted shower head

With 2 stream types (rain/cascade). Water supply via 2 independent ways. Dimensions: 500x650 mm. Material: Stainless steel. Anti-limescale nozzles.

Soffione doccia soffitto a incasso da soffitto

Con 2 tipi di getto (pioggia/cascata). Alimentazione mediante 2 vie di acqua indipendenti. Dimensioni: 500x650 mm. Materiale: Acciaio inossidabile. Fori anticalcare.



- 29997001 1.440,00
- 29997001NM 2.232,00
- 29997001BM 2.232,00
- 29997001AC 2.232,00
- 29997001OR 3.168,00
- 29997001OM 3.168,00

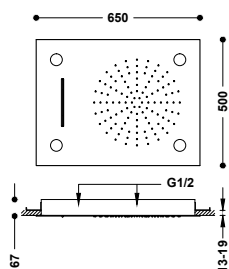

Concealed ceiling-mounted shower head with Chromotherapy

With 2 stream types (rain/cascade). Water supply via 2 independent ways. Dimensions: 500x650 mm. Material: Stainless steel. Anti-limescale nozzles. LED lights are activated with a switch (not included).

Soffione doccia da soffitto a incasso con Cromoterapia

Con 2 tipi di getto (pioggia/cascata). Alimentazione mediante 2 vie di acqua indipendenti. Dimensioni: 500x650 mm. Materiale: Acciaio inossidabile. Fori anticalcare. Le luci a LED si attivano con un interruttore (non incluso).



- 29997201 2.440,00

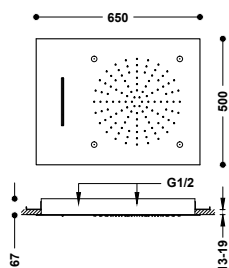

Concealed ceiling-mounted shower head

With 3 stream types (rain/cascade/micro drop). Water supply via 3 independent ways. Dimensions: 500x650 mm. Material: Stainless steel. Anti-limescale nozzles.

Soffione doccia soffitto a incasso da soffitto

Con 3 tipi di getto (pioggia/cascata/micro drop). Alimentazione mediante 3 vie di acqua indipendenti. Dimensioni: 500x650 mm. Materiale: Acciaio inossidabile. Fori anticalcare.



- 29997101 1.540,00

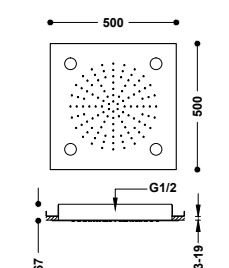

Concealed ceiling-mounted shower head with Chromotherapy

Dimensions: 500x500 mm. Material: Stainless steel. Anti-limescale nozzles. LED lights activated automatically or with a switch (not included).

Soffione doccia da soffitto a incasso con Cromoterapia

Dimensioni: 500x500 mm. Materiale: Acciaio inossidabile. Fori anticalcare. Le luci a LED si attivano automaticamente o con un interruttore (non incluso).



- 29996201 1.390,00

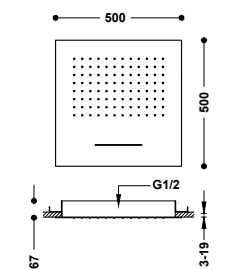

Concealed ceiling-mounted shower head

With 2 stream types (rain/cascade). Water supply via 2 independent ways. Dimensions: 500x500 mm. Material: Stainless steel. Anti-limescale nozzles.

Soffione doccia soffitto a incasso da soffitto

Con 2 tipi di getto (pioggia/cascata). Alimentazione mediante 2 vie di acqua indipendenti. Dimensioni: 500x500 mm. Materiale: Acciaio inossidabile. Fori anticalcare.



- 29995501 1.135,00
- 29995501NM 1.759,00
- 29995501BM 1.759,00
- 29995501AC 1.759,00
- 29995501OR 2.497,00 N
- 29995501OM 2.497,00 N

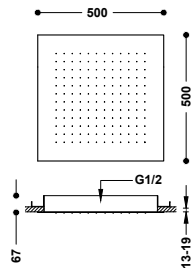

Concealed ceiling-mounted shower head

Dimensions: 500x500 mm. Material: Stainless steel. Anti-limescale nozzles.

Soffione doccia soffitto a incasso da soffitto

Dimensioni: 500x500 mm. Materiale: Acciaio inossidabile. Fori anticalcare.



134951	1.030,00
134951NM	1.597,00
134951BM	1.597,00
134951AC	1.597,00
134951OR	2.266,00
134951OM	2.266,00
134951OP	2.152,00 N
134951OPM	2.152,00 N

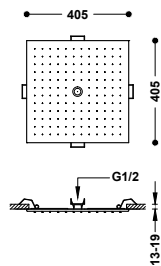

Concealed ceiling-mounted shower head

With 2 stream types (rain/free flow). Water supply via 2 independent ways. Dimensions: 405x405 mm. Material: Stainless steel. Anti-limescale nozzles.

Soffione doccia soffitto a incasso da soffitto

Con 2 tipi di getto (pioggia/free flow). Alimentazione mediante 2 vie di acqua indipendenti. Dimensioni: 405x405 mm. Materiale: Acciaio inossidabile. Fori anticalcare.



13495102	895,00
13495102NM	1.387,00
13495102BM	1.387,00
13495102AC	1.387,00
13495102KM	1.387,00
13495102KMB	1.387,00
13495102OR	1.969,00
13495102OM	1.969,00
13495102OP	1.969,00
13495102OPM	1.969,00

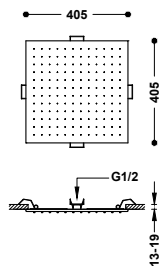

Concealed ceiling-mounted shower head

Dimensions: 405x405 mm. Material: Stainless steel. Anti-limescale nozzles.

Soffione doccia soffitto a incasso da soffitto

Dimensioni: 405x405 mm. Materiale: Acciaio inossidabile. Fori anticalcare.



13495101	825,00
13495101NM	1.279,00
13495101BM	1.279,00
13495101AC	1.279,00
13495101KM	1.279,00
13495101KMB	1.279,00
13495101OR	1.815,00
13495101OM	1.815,00
13495101OP	1.815,00
13495101OPM	1.815,00

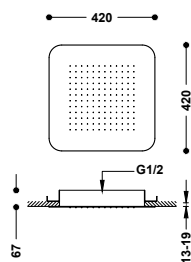

Concealed ceiling-mounted shower head

Dimensions: 420x420 mm. Material: Stainless steel. Anti-limescale nozzles.

Soffione doccia soffitto a incasso da soffitto

Dimensioni: 420x420 mm. Materiale: Acciaio inossidabile. Fori anticalcare.



29951607	920,00
29951607NM	1.426,00
29951607BM	1.426,00
29951607AC	1.426,00
29951607OR	2.024,00
29951607OM	2.024,00

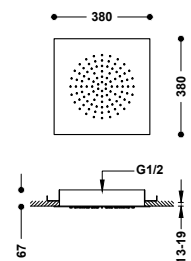

Concealed ceiling-mounted shower head

Dimensions: 380x380 mm. Material: Stainless steel. Anti-limescale nozzles.

Soffione doccia soffitto a incasso da soffitto

Dimensioni: 380x380 mm. Materiale: Acciaio inossidabile. Fori anticalcare.



29995301	790,00
29995301NM	1.225,00
29995301BM	1.225,00
29995301AC	1.225,00
29995301OR	1.738,00
29995301OM	1.738,00



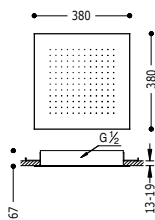

Concealed ceiling-mounted shower head

Dimensions: 380x380 mm. Material: Stainless steel. Anti-limescale nozzles.

Soffione doccia soffitto a incasso da soffitto

Dimensioni: 380x380 mm. Materiale: Acciaio inossidabile. Fori anticalcare.

- 134944 820,00
- 134944NM 1.271,00
- 134944BM 1.271,00
- 134944AC 1.271,00
- 134944OR 1.804,00
- 134944OM 1.804,00

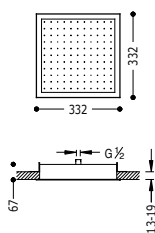

Concealed ceiling-mounted shower head

Dimensions: 332x332 mm. Material: brass. Anti-limescale nozzles.

Soffione doccia soffitto a incasso da soffitto

Dimensioni: 332x332 mm. Materiale: ottone. Fori anticalcare.

- 134714 530,00

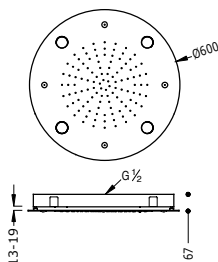
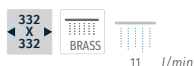

Concealed ceiling-mounted shower head with Chromotherapy

With 2 stream types (rain/micro drop). Water supply via 2 independent ways. Dimensions: Ø 600 mm. Material: Stainless steel. Anti-limescale nozzles. LED lights are activated with a switch (not included).

Soffione doccia da soffitto a incasso con Cromoterapia

Con 2 tipi di getto (pioggia/micro drop). Alimentazione mediante 2 vie di acqua indipendenti. Dimensioni: Ø 600 mm. Materiale: Acciaio inossidabile. Fori anticalcare. Le luci a LED si attivano con un interruttore (non incluso).

- 29995801 2.440,00

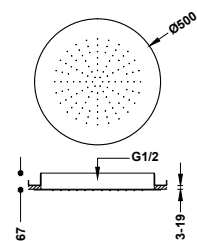

Concealed ceiling-mounted shower head

Dimensions: Ø 500 mm. Material: Stainless steel. Anti-limescale nozzles.

Soffione doccia soffitto a incasso da soffitto

Dimensioni: Ø 500 mm. Materiale: Acciaio inossidabile. Fori anticalcare.

- 134950 1.030,00
- 134950NM 1.597,00
- 134950BM 1.597,00
- 134950AC 1.597,00
- 134950OR 2.266,00
- 134950OM 2.266,00

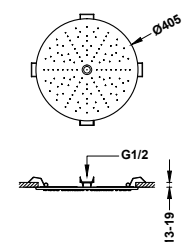

Concealed ceiling-mounted shower head

With 2 stream types (rain/free flow). Water supply via 2 independent ways. Dimensions: Ø 405 mm. Material: Stainless steel. Anti-limescale nozzles.

Soffione doccia soffitto a incasso da soffitto

Con 2 tipi di getto (pioggia/free flow). Alimentazione mediante 2 vie di acqua indipendenti. Dimensioni: Ø 405 mm. Materiale: Acciaio inossidabile. Fori anticalcare.

- 13495002 861,00
- 13495002NM 1.335,00
- 13495002BM 1.335,00
- 13495002AC 1.335,00
- 13495002KM 1.335,00
- 13495002KMB 1.335,00
- 13495002OR 1.894,00
- 13495002OM 1.894,00
- 13495002OP 1.894,00
- 13495002OPM 1.894,00



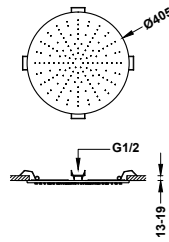

Concealed ceiling-mounted shower head

Dimensions: Ø 405 mm. Material: Stainless steel. Anti-limescale nozzles.

Soffione doccia soffitto a incasso da soffitto

Dimensioni: Ø 405 mm. Materiale: Acciaio inossidabile. Fori anticalcare.



13495001	775,00
13495001NM	1.201,00
13495001BM	1.201,00
13495001AC	1.201,00
13495001KM	1.201,00
13495001KMB	1.201,00
13495001OR	1.705,00
13495001OM	1.705,00
13495001OP	1.705,00
13495001OPM	1.705,00

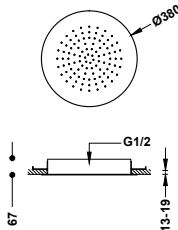

Concealed ceiling-mounted shower head

Dimensions: Ø 380 mm. Material: Stainless steel. Anti-limescale nozzles.

Soffione doccia soffitto a incasso da soffitto

Dimensioni: Ø 380 mm. Materiale: Acciaio inossidabile. Fori anticalcare.



134940	820,00
134940NM	1.271,00
134940BM	1.271,00
134940AC	1.271,00
134940KM	1.271,00
134940KMB	1.271,00
134940OR	1.804,00
134940OM	1.804,00
134940OP	1.804,00
134940OPM	1.804,00

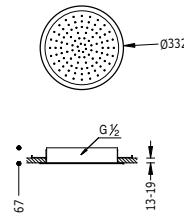

Concealed ceiling-mounted shower head

Dimensions: Ø 332 mm. Material: brass. Anti-limescale nozzles.

Soffione doccia soffitto a incasso da soffitto

Dimensioni: Ø 332 mm. Materiale: ottone. Fori anticalcare.



134715	530,00
--------	--------

CEILING SHOWER HEADS / SOFFIONI DA SOFFITTO

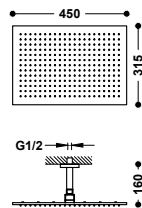

Ceiling-mounted arm with adjustable shower head

Ceiling-mounted arm: 160 mm. Adjustable shower head: 450x315 mm. Material: Brass.

Braccio a soffitto con soffione doccia orientabile

Braccio a soffitto: 160 mm. Soffione doccia orientabile: 450x315 mm. Materiale: Ottone.



03443203	425,00
----------	--------

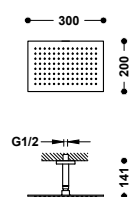

Ceiling-mounted arm with adjustable shower head

Ceiling-mounted arm: 141 mm. Adjustable shower head: 300x200 mm. Material: Stainless steel.

Braccio a soffitto con soffione doccia orientabile

Braccio a soffitto: 141 mm. Soffione doccia orientabile: 300x200 mm. Materiale: Acciaio inossidabile.



03443202	270,00
----------	--------



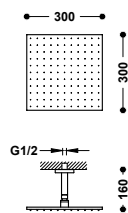

Ceiling-mounted arm with adjustable shower head

03483102

318,00

Ceiling-mounted arm: 157 mm. Adjustable shower head: 300x300 mm. Material: Brass.

Braccio a soffitto con soffione doccia orientabile

Braccio a soffitto: 157 mm. Soffione doccia orientabile: 300x300 mm. Materiale: Ottone.

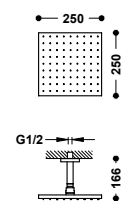

Ceiling-mounted arm with adjustable shower head

03412102

142,00

Ceiling-mounted arm: 166 mm. Adjustable shower head: 250x250 mm.

Braccio a soffitto con soffione doccia orientabile

Braccio a soffitto: 166 mm. Soffione doccia orientabile: 250x250 mm.

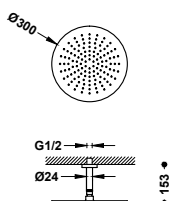

Ceiling-mounted arm with adjustable shower head

134331

185,00

Ceiling-mounted arm: 153 mm. Adjustable shower head: Ø 300 mm. Material: Stainless steel.

Braccio a soffitto con soffione doccia orientabile

Braccio a soffitto: 153 mm. Soffione doccia orientabile: Ø 300 mm. Materiale: Acciaio inossidabile.

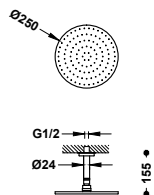

Ceiling-mounted arm with adjustable shower head

134221

125,00

Ceiling-mounted arm: 155 mm. Adjustable shower head: Ø 250 mm.

Braccio a soffitto con soffione doccia orientabile

Braccio a soffitto: 155 mm. Soffione doccia orientabile: Ø 250 mm.



WALL SHOWER HEADS / SOFFIONI A MURO

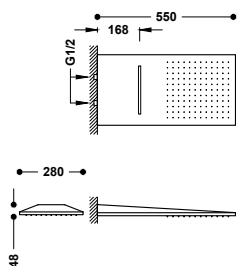

Wall-mounted shower head

With 2 stream types (rain/cascade). Water supply via 2 independent ways. Dimensions: 280x550 mm. Material: Stainless steel. Anti-limescale nozzles.

Soffione doccia a muro

Con 2 tipi di getto (pioggia/cascata). Alimentazione mediante 2 vie di acqua indipendenti. Dimensioni: 280x550 mm. Materiale: Acciaio inossidabile. Fori anticalcare.



29990301

755,00

29990301NM

1.170,00

29990301BM

1.170,00

29990301AC

1.170,00

29990301OR

1.661,00

29990301OM

1.661,00

29990301OPM

1.661,00

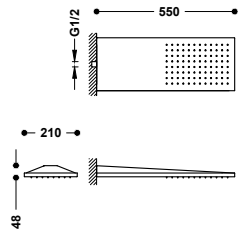

Wall-mounted shower head

Dimensions: 210x550 mm. Material: Stainless steel. Anti-limescale nozzles.

Soffione doccia a muro

Dimensioni: 210x550 mm. Materiale: Acciaio inossidabile. Fori anticalcare.



	29990302	555,00
	29990302NM	860,00
	29990302BM	860,00
	29990302AC	860,00
	29990302OR	1.221,00
	29990302OM	1.221,00
	29990302OPM	1.221,00 N

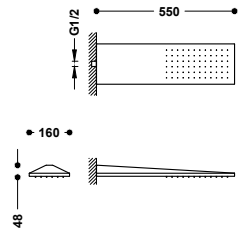

Wall-mounted shower head

Dimensions: 160x550 mm. Material: Stainless steel. Anti-limescale nozzles.

Soffione doccia a muro

Dimensioni: 160x550 mm. Materiale: Acciaio inossidabile. Fori anticalcare.



	29990303	455,00
	29990303NM	705,00
	29990303BM	705,00
	29990303AC	705,00
	29990303KM	705,00
	29990303KMB	705,00
	29990303OR	1.001,00
	29990303OM	1.001,00
	29990303OP	1.001,00
	29990303OPM	1.001,00

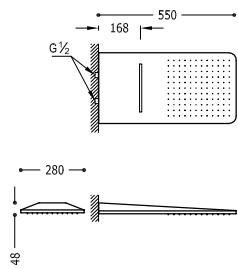

Wall-mounted shower head

With 2 stream types (rain/cascade). Water supply via 2 independent ways. Dimensions: 280x550 mm. Material: Stainless steel. Anti-limescale nozzles.

Soffione doccia a muro

Con 2 tipi di getto (pioggia/cascata). Alimentazione mediante 2 vie di acqua indipendenti. Dimensione: 280x550 mm. Materiale: Acciaio inossidabile. Fori anticalcare.



	29990308	815,00
	29990308NM	1.263,00
	29990308BM	1.263,00
	29990308AC	1.263,00
	29990308OR	1.793,00
	29990308OM	1.793,00
	29990308OP	1.793,00
	29990308OPM	1.793,00 N

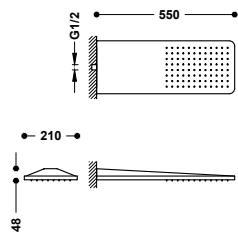

Wall-mounted shower head

Dimensions: 210x550 mm. Material: Stainless steel. Anti-limescale nozzles.

Soffione doccia a muro

Dimensioni: 210x550 mm. Materiale: Acciaio inossidabile. Fori anticalcare.



	29990307	615,00
	29990307NM	953,00
	29990307BM	953,00
	29990307AC	953,00
	29990307KM	953,00
	29990307KMB	953,00
	29990307OR	1.353,00
	29990307OM	1.353,00
	29990307OP	1.353,00
	29990307OPM	1.353,00

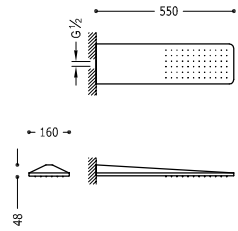

Wall-mounted shower head

Dimensions: 160x550 mm. Material: Stainless steel. Anti-limescale nozzles.

Soffione doccia a muro

Dimensioni: 160x550 mm. Materiale: Acciaio inossidabile. Fori anticalcare.



	29990306	515,00
	29990306NM	798,00
	29990306BM	798,00
	29990306AC	798,00
	29990306OR	1.133,00
	29990306OM	1.133,00



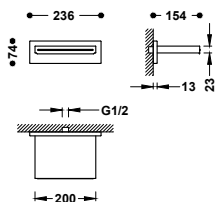

Wall-mounted shower head

With cascade outlet. Material: Stainless steel. Dimensions: 154x200 mm.

Soffione doccia a muro

Con getto a cascata. Materiale: Acciaio inossidabile. Dimensioni: 154x200 mm.



- 29990304 450,00
- 29990304NM 698,00
- 29990304BM 698,00
- 29990304AC 698,00
- 29990304KMB 698,00
- 29990304OR 990,00
- 29990304OM 990,00
- 29990304OPM 990,00

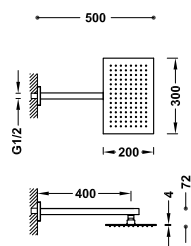

Wall-mounted arm with adjustable shower head

Wall-mounted arm: 400 mm. Adjustable shower head: 300x200 mm. Material: Stainless steel.

Braccio a muro con soffione doccia orientabile

Braccio a muro: 400 mm. Soffione doccia orientabile: 300x200 mm. Materiale: Acciaio inossidabile.



- 29953202 295,00

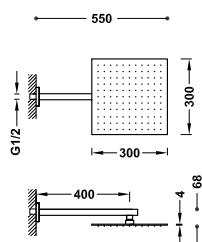

Wall-mounted arm with adjustable shower head

Wall-mounted arm: 400 mm. Adjustable shower head: 300x300 mm. Material: Stainless steel.

Braccio a muro con soffione doccia orientabile

Braccio a muro: 400 mm. Soffione doccia orientabile: 300x300 mm. Materiale: Acciaio inossidabile.



- 134433 340,00

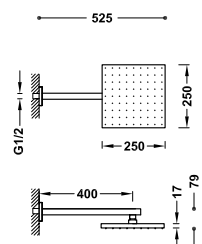

Wall-mounted arm with adjustable shower head

Wall-mounted arm: 400 mm. Adjustable shower head: 250x250 mm.

Braccio a muro con soffione doccia orientabile

Braccio a muro: 400 mm. Soffione doccia orientabile: 250x250 mm.

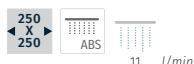

- 134233 163,00

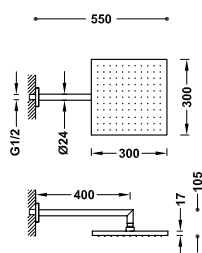

Wall-mounted arm with adjustable shower head

Wall-mounted arm: 400 mm. Adjustable shower head: 300x300 mm. Material: Brass.

Braccio a muro con soffione doccia orientabile

Braccio a muro: 400 mm. Soffione doccia orientabile: 300x300 mm. Materiale: Ottone.



- 03443101 350,00

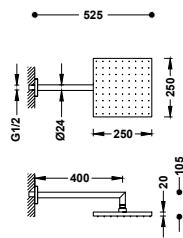

Wall-mounted arm with adjustable shower head
 Wall-mounted arm: 400 mm. Adjustable shower head: 250x250 mm.

03423101 159,00

Braccio a muro con soffione doccia orientabile
 Braccio a muro: 400 mm. Soffione doccia orientabile: 250x250 mm.

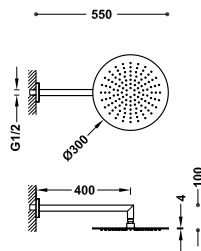
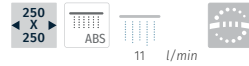

Wall-mounted arm with adjustable shower head
 Wall-mounted arm: 400 mm. Adjustable shower head: Ø 300 mm. Material: Stainless steel.

134432 220,00

Braccio a muro con soffione doccia orientabile
 Braccio a muro: 400 mm. Soffione doccia orientabile: Ø 300 mm. Materiale: Acciaio inossidabile.

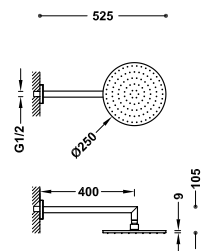

Wall-mounted arm with adjustable shower head
 Wall-mounted arm: 400 mm. Adjustable shower head: Ø 250 mm.

134232 151,00

Braccio a muro con soffione doccia orientabile
 Braccio a muro: 400 mm. Soffione doccia orientabile: Ø 250 mm.



SHOWER HEADS AND ARMS / SOFFIONI E BRACCI

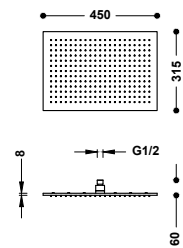

Shower head
 Dimensions: 450x315 mm. Adjustable shower head. Material: Brass. Anti-limescale nozzles.

- 29963203 360,00
- 29963203NM 558,00
- 29963203BM 558,00
- 29963203AC 558,00
- 29963203OR 792,00
- 29963203OM 792,00

Soffione doccia
 Dimensioni: 450x315 mm. Supporto orientabile. Materiale: Ottone. Fori anticalcare.

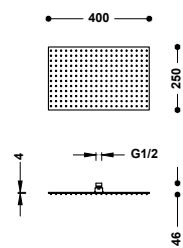
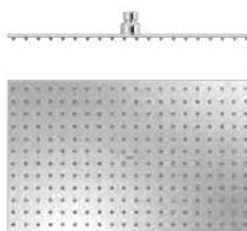

Shower head
 Extra-slim: 4 mm. Dimensions: 400x250 mm. Adjustable shower head. Material: Stainless steel. Anti-limescale nozzles.

- 134315008 260,00
- 134315008NM 403,00
- 134315008BM 403,00
- 134315008AC 403,00
- 134315008OR 572,00
- 134315008OM 572,00

Soffione doccia
 Ultrasottile: 4 mm. Dimensioni: 400x250 mm. Supporto orientabile. Materiale: Acciaio inossidabile. Fori anticalcare.



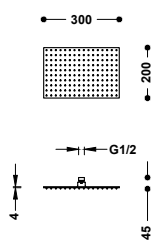
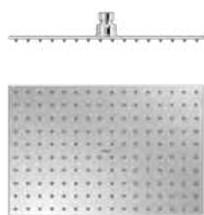

Shower head

Extra-slim: 4 mm. Dimensions: 300x200 mm. Adjustable shower head. Material: Stainless steel. Anti-limescale nozzles.

Soffione doccia

Ultrasottile: 4 mm. Dimensioni: 300x200 mm. Supporto orientabile. Materiale: Acciaio inossidabile. Fori anticalcare.



- 134315007 205,00
- 134315007NM 318,00
- 134315007BM 318,00
- 134315007AC 318,00
- 134315007KMB 318,00
- 134315007OR 451,00
- 134315007OM 451,00
- 134315007OP 451,00
- 134315007OPM 451,00

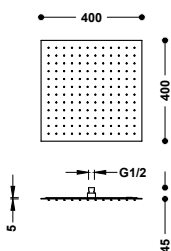
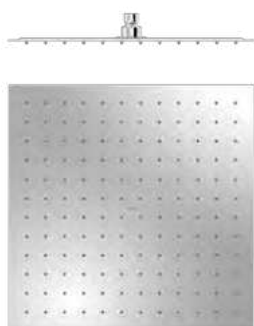

Shower head

Dimensions: 400x400 mm. Adjustable shower head. Material: Stainless steel. Incorporates a membrane pressure relief valve. Anti-limescale nozzles.

Soffione doccia

Dimensioni: 400x400 mm. Supporto orientabile. Materiale: Acciaio inossidabile. Dotato di una valvola limitatrice di pressione a membrana. Fori anticalcare.



- 134315014 220,00

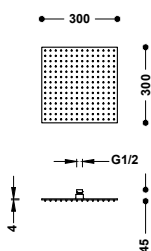
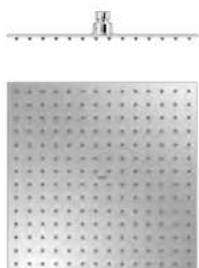

Shower head

Extra-slim: 4 mm. Dimensions: 300x300 mm. Adjustable shower head. Material: Stainless steel. Anti-limescale nozzles.

Soffione doccia

Ultrasottile: 4 mm. Dimensioni: 300x300 mm. Supporto orientabile. Materiale: Acciaio inossidabile. Fori anticalcare.



- 134315012 172,00
- 134315012NM 267,00
- 134315012BM 267,00
- 134315012AC 267,00
- 134315012KM 267,00
- 134315012KMB 267,00
- 134315012OR 378,00
- 134315012OM 378,00
- 134315012OP 378,00
- 134315012OPM 378,00

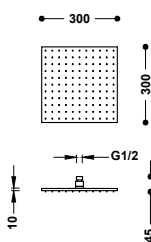
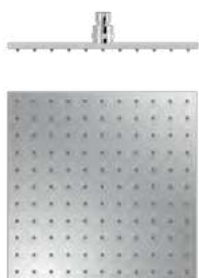

Shower head

Dimensions: 300x300 mm. Adjustable shower head. Material: Brass. Anti-limescale nozzles.

Soffione doccia

Dimensioni: 300x300 mm. Supporto orientabile. Materiale: Ottone. Fori anticalcare.



- 13413830 268,00
- 13413830NM 415,00
- 13413830BM 415,00
- 13413830AC 415,00
- 13413830KM 415,00
- 13413830KMB 415,00
- 13413830OR 590,00
- 13413830OM 590,00
- 13413830OP 590,00
- 13413830OPM 590,00

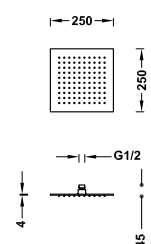
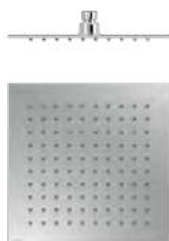

Shower head

Extra-slim: 4 mm. Dimensions: 250x250 mm. Adjustable shower head. Material: Stainless steel. Anti-limescale nozzles.

Soffione doccia

Ultrasottile: 4 mm. Dimensioni: 250x250 mm. Supporto orientabile. Materiale: Acciaio inossidabile. Fori anticalcare.



- 134315011 145,00

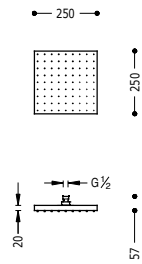
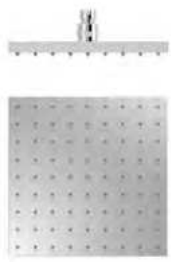

Shower head

13413826

82,00

Dimensions: 250x250 mm. Adjustable shower head. Anti-limescale nozzles.

Soffione doccia

Dimensioni: 250x250 mm. Supporto orientabile. Fori anticalcare.

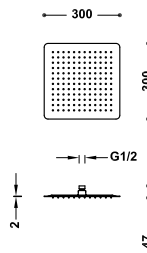

Shower head

134315006

149,00

Dimensions: 300x300 mm. Adjustable shower head. Material: Stainless steel. Anti-limescale nozzles.

Soffione doccia

Dimensioni: 300x300 mm. Supporto orientabile. Materiale: Acciaio inossidabile. Fori anticalcare.

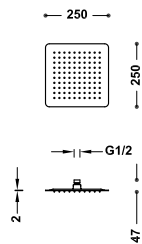

Shower head

134315004

125,00

Dimensions: 250x250 mm. Adjustable shower head. Material: Stainless steel. Anti-limescale nozzles.

Soffione doccia

Dimensioni: 250x250 mm. Supporto orientabile. Materiale: Acciaio inossidabile. Fori anticalcare.

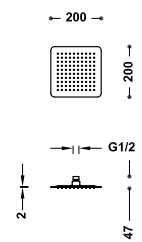

Shower head

134315002

77,00

Dimensions: 200x200 mm. Adjustable shower head. Material: Stainless steel. Anti-limescale nozzles.

Soffione doccia

Dimensioni: 200x200 mm. Supporto orientabile. Materiale: Acciaio inossidabile. Fori anticalcare.

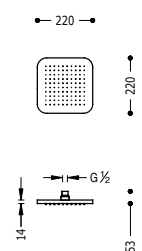

Shower head

29963206

135,00

Dimensions: 220x220 mm. Adjustable shower head. Anti-limescale nozzles.

Soffione doccia

Dimensioni: 220x220 mm. Supporto orientabile. Fori anticalcare.



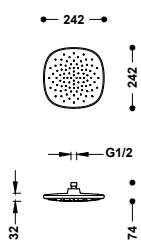

Shower head

Dimensions: 242x242 mm. Adjustable shower head. Anti-limescale nozzles.

Soffione doccia

Dimensioni: 242x242 mm. Supporto orientabile. Fori anticalcare.



29943801 54,00

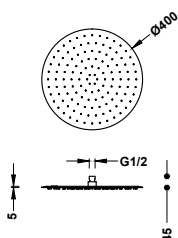

Shower head

Dimensions: Ø 400 mm. Adjustable shower head. Material: Stainless steel. Incorporates a membrane pressure relief valve. Anti-limescale nozzles.

Soffione doccia

Dimensioni: Ø 400 mm. Supporto orientabile. Materiale: Acciaio inossidabile. Dotato di una valvola limitatrice di pressione a membrana. Fori anticalcare.



134315015 172,00

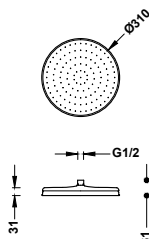

Shower head Clasic

Dimensions: Ø 310 mm. Adjustable shower head. Material: Brass. Anti-limescale nozzles.

Soffione doccia Clasic

Dimensioni: Ø 310 mm. Supporto orientabile. Materiale: Ottone. Fori anticalcare.



29933703 268,00
 29933703AC 415,00
 29933703OR 590,00
 29933703LV 389,00
 29933703LM 389,00

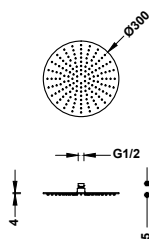
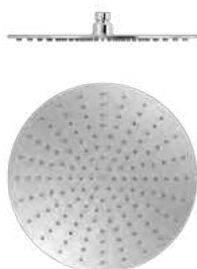

Shower head

Extra-slim: 4 mm. Dimensions: Ø 300 mm. Adjustable shower head. Material: Stainless steel. Anti-limescale nozzles.

Soffione doccia

Ultrasottile: 4 mm. Dimensioni: Ø 300 mm. Supporto orientabile. Materiale: Acciaio inossidabile. Fori anticalcare.



134315010 145,00
 134315010NM 225,00
 134315010BM 225,00
 134315010AC 225,00
 134315010KM 225,00
 134315010KMB 225,00
 134315010OR 319,00
 134315010OM 319,00
 134315010OP 319,00
 134315010OPM 319,00

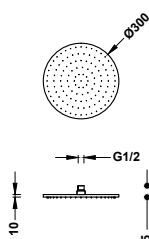

Shower head

Dimensions: Ø 300 mm. Adjustable shower head. Material: Brass. Anti-limescale nozzles.

Soffione doccia

Dimensioni: Ø 300 mm. Supporto orientabile. Materiale: Ottone. Fori anticalcare.



13413730 256,00
 13413730NM 397,00
 13413730BM 397,00
 13413730AC 397,00
 13413730KM 397,00
 13413730KMB 397,00
 13413730OR 563,00
 13413730OM 563,00
 13413730OP 563,00
 13413730OPM 563,00

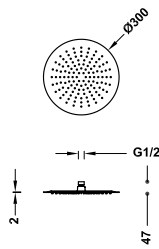

Shower head

134315005

130,00

Dimensions: Ø 300 mm. Adjustable shower head. Material: Stainless steel. Anti-limescale nozzles.

Soffione doccia

Dimensioni: Ø 300 mm. Supporto orientabile. Materiale: Acciaio inossidabile. Fori anticalcare.

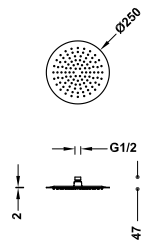

Shower head

134315003

103,00

Dimensions: Ø 250 mm. Adjustable shower head. Material: Stainless steel. Anti-limescale nozzles.

Soffione doccia

Dimensioni: Ø 250 mm. Supporto orientabile. Materiale: Acciaio inossidabile. Fori anticalcare.

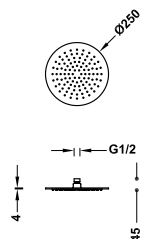

Shower head

134315009

98,00

Extra-slim: 4 mm. Dimensions: Ø 250 mm. Adjustable shower head. Material: Stainless steel. Anti-limescale nozzles.

Soffione doccia

Ultrasottile: 4 mm. Dimensioni: Ø 250 mm. Supporto orientabile. Materiale: Acciaio inossidabile. Fori anticalcare.

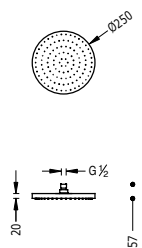

Shower head

13413726

82,00

Dimensions: Ø 250 mm. Adjustable shower head. Anti-limescale nozzles.

Soffione doccia

Dimensioni: Ø 250 mm. Supporto orientabile. Fori anticalcare.

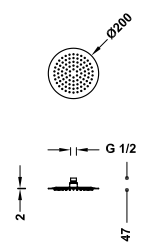

Shower head

134315001

57,00

Dimensions: Ø 200 mm. Adjustable shower head. Material: Stainless steel. Anti-limescale nozzles.

Soffione doccia

Dimensioni: Ø 200 mm. Supporto orientabile. Materiale: Acciaio inossidabile. Fori anticalcare.



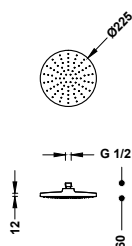

Shower head Autoclean

13431513

46,00

Dimensions: Ø 225 mm. Adjustable shower head. Self-cleaning anti-limescale nozzles

Soffione doccia Autoclean

Dimensioni: Ø 225 mm. Supporto orientabile. Fori anticalcare autopulenti.



**SELF-CLEANING ANTI-LIMESCALE NOZZLES
SOFFIONI ANTICALCARE AUTOPULENTI**

Every time the tap is turned off, small teeth cover the nozzles to clean them and leave them unblocked when the water flows out again.

Ogni volta che si chiude il miscelatore, i fori vengono chiusi e puliti da dentelli anticalcare che si ritirano al momento del getto successivo.

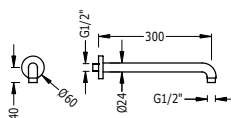

Wall-mounted arm

13462101

65,00

For shower head. Length: 300 mm.

Braccio a muro

Per soffione doccia. Lunghezza: 300 mm.

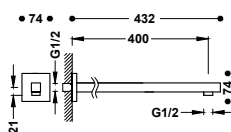

Wall-mounted arm

13413940

90,00

For shower head. Length: 400 mm.

13413940NM

140,00

13413940BM

140,00

13413940AC

140,00

13413940OR

198,00

13413940OM

198,00

13413940OPM

198,00

Braccio a muro

Per soffione doccia. Lunghezza: 400 mm.

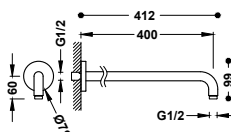

Wall-mounted arm

13462104

77,00

For shower head. Length: 400 mm.

13462104NM

119,00

13462104BM

119,00

13462104AC

119,00

13462104KM

119,00

13462104KMB

119,00

13462104OR

169,00

13462104OM

169,00

13462104OP

169,00

13462104OPM

169,00

Braccio a muro

Per soffione doccia. Lunghezza: 400 mm.

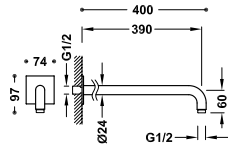

Wall-mounted arm

For shower head. Length: 390 mm.

Braccio a muro

Per soffione doccia. Lunghezza: 390 mm.

13463302

79,00

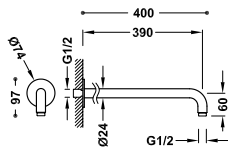

Wall-mounted arm

For shower head. Length: 390 mm.

Braccio a muro

Per soffione doccia. Lunghezza: 390 mm.

13463303

77,00

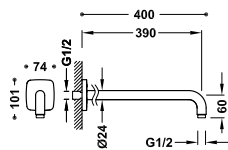

Wall-mounted arm

For shower head. Length: 390 mm.

Braccio a muro

Per soffione doccia. Lunghezza: 390 mm.

13463301

79,00

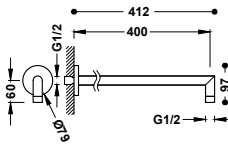

Wall-mounted arm

For shower head. Length: 400 mm.

Braccio a muro

Per soffione doccia. Lunghezza: 400 mm.

16118740

77,00

16118740NM

119,00

16118740BM

119,00

16118740AC

119,00

16118740KMB

119,00

16118740OR

169,00

16118740OM

169,00

16118740OP

169,00

16118740OPM

169,00

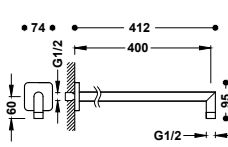

Wall-mounted arm

For shower head. Length: 400 mm.

Braccio a muro

Per soffione doccia. Lunghezza: 400 mm.

29963902

85,00

29963902NM

132,00

29963902BM

132,00

29963902AC

132,00

29963902KMB

132,00

29963902OR

187,00

29963902OM

187,00

29963902OP

187,00

29963902OPM

187,00



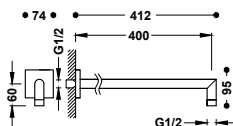

Wall-mounted arm

For shower head. Length: 400 mm.

Braccio a muro

Per soffione doccia. Lunghezza: 400 mm.

06243201	85,00
06243201NM	132,00
06243201BM	132,00
06243201AC	132,00
06243201KM	132,00
06243201KMB	132,00
06243201OR	187,00
06243201OM	187,00
06243201OP	187,00
06243201OPM	187,00

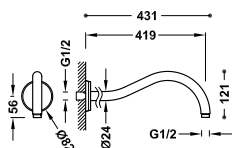

Wall-mounted arm Clasic

For shower head. Length: 419 mm.

Braccio a muro Clasic

Per soffione doccia. Lunghezza: 419 mm.

29933701	84,00
29933701AC	130,00
29933701OR	185,00
29933701LV	122,00
29933701LM	122,00

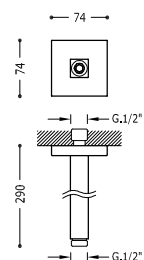

Ceiling-mounted arm

For shower head. Length: 290 mm.

Braccio a soffitto

Per soffione doccia. Lunghezza: 290 mm.

13462202	77,00
13462202NM	119,00
13462202BM	119,00
13462202AC	119,00
13462202OR	169,00
13462202OM	169,00

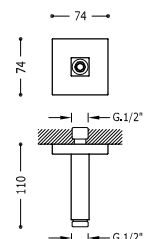

Ceiling-mounted arm

For shower head. Length: 110 mm.

Braccio a soffitto

Per soffione doccia. Lunghezza: 110 mm.

13452202	67,00
13452202NM	104,00
13452202BM	104,00
13452202AC	104,00
13452202OR	147,00
13452202OM	147,00

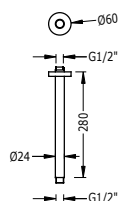

Ceiling-mounted arm

For shower head. Length: 280 mm.

Braccio a soffitto

Per soffione doccia. Lunghezza: 280 mm.

13462102	60,00
13462102NM	93,00
13462102BM	93,00
13462102AC	93,00
13462102KMB	93,00
13462102OR	132,00
13462102OM	132,00
13462102OP	132,00
13462102OPM	132,00

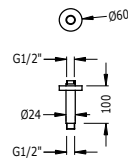

Ceiling-mounted arm

For shower head. Length: 100 mm.

Braccio a soffitto

Per soffione doccia. Lunghezza: 100 mm.

	13452102	50,00
	13452102NM	78,00
	13452102BM	78,00
	13452102AC	78,00
	13452102KM	78,00
	13452102KMB	78,00
	13452102OR	110,00
	13452102OM	110,00
	13452102OP	110,00
	13452102OPM	110,00

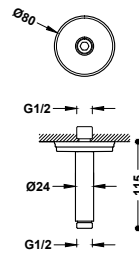

Wall-mounted arm Clasic

For shower head. Length: 115 mm.

Braccio a muro Clasic

Per soffione doccia. Lunghezza: 115 mm.

	29933702	60,00
	29933702AC	93,00
	29933702OR	132,00
	29933702LV	87,00
	29933702LM	87,00

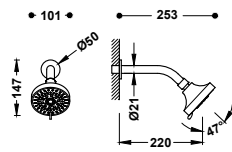

Wall-mounted arm with adjustable shower head

Adjustable shower head. Dimensions: Ø 100 mm. 3 stream types.

Braccio a muro con soffione doccia orientabile

Supporto orientabile. Dimensioni: Ø 100 mm. 3 tipi di getto.

	13463304	44,00
--	----------	-------

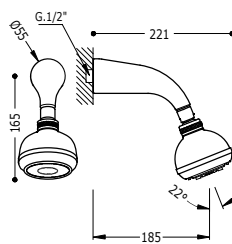
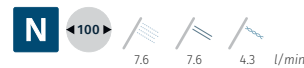

Wall-mounted arm with adjustable shower head

Adjustable shower head. Dimensions: Ø 93 mm. 3 stream types.

Braccio a muro con soffione doccia orientabile

Supporto orientabile. Dimensioni: Ø 93 mm. 3 tipi di getto.

	134818	86,00
--	--------	-------

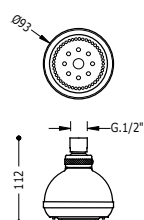

Shower head

Adjustable shower head. Dimensions: Ø 93 mm. 3 stream types.

Soffione doccia

Supporto orientabile. Dimensioni: Ø 93 mm. 3 tipi di getto.

	913481810	26,00
--	-----------	-------

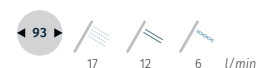

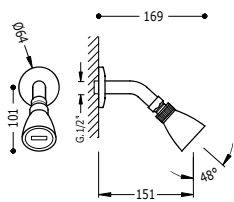

Wall-mounted arm with adjustable shower head

134738

56,00

Adjustable shower head. Dimensions: Ø 54 mm.

Braccio a muro con soffione doccia orientabile

Supporto orientabile. Dimensioni: Ø 54 mm.

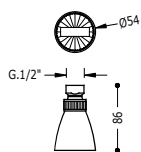

Shower head

913473810

36,00

Adjustable shower head. Dimensions: Ø 54 mm.

Soffione doccia

Supporto orientabile. Dimensioni: Ø 54 mm.

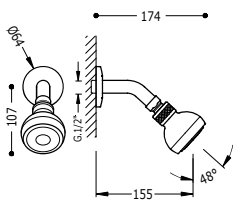

Wall-mounted arm with adjustable shower head

134808

39,00

Adjustable shower head. Dimensions: Ø 70 mm. Anti-limescale nozzles.

Braccio a muro con soffione doccia orientabile

Supporto orientabile. Dimensioni: Ø 70 mm. Fori anticalcare.

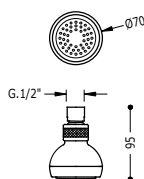

Shower head

913480810

19,00

Adjustable shower head. Dimensions: Ø 70 mm. Anti-limescale nozzles.

Soffione doccia

Supporto orientabile. Dimensioni: Ø 70 mm. Fori anticalcare.

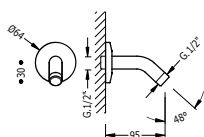

Wall-mounted arm for shower head

13473850

20,00

For shower head. Length: 95 mm.

Braccio a muro per soffione doccia

Per soffione doccia. Lunghezza: 95 mm.

HAND SHOWERS / DOCCINI

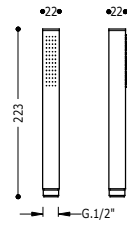

Hand shower Quadro

Material: Brass. Anti-limescale nozzles.

Doccino Quadro

Materiale: Ottone. Fori anticalcare.



00663901	46,00
00663901NM	71,00
00663901BM	71,00
00663901AC	71,00
00663901KM	71,00
00663901KMB	71,00
00663901OR	101,00
00663901OM	101,00
00663901OP	101,00
00663901OPM	101,00

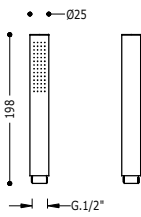

Hand shower Tub

Material: Brass. Anti-limescale nozzles.

Doccino Tub

Materiale: Ottone. Fori anticalcare.

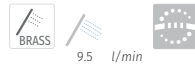

03411601	41,00
03411601NM	64,00
03411601BM	64,00
03411601AC	64,00
03411601KM	64,00
03411601KMB	64,00
03411601OR	90,00
03411601OM	90,00
03411601OP	90,00
03411601OPM	90,00

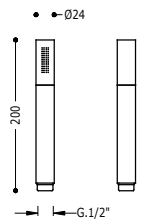

Hand shower

Material: Brass.

Doccino

Materiale: Ottone.

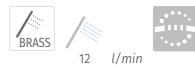

913412380	31,00
-----------	-------

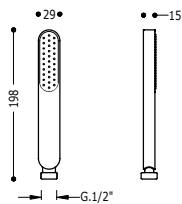

Hand shower Oval

Anti-limescale nozzles.

Doccino Oval

Fori anticalcare.



03463901	39,00
03463901NM	60,00
03463901BM	60,00
03463901AC	60,00
03463901KMB	60,00
03463901OR	86,00
03463901OM	86,00
03463901OP	86,00
03463901OPM	86,00

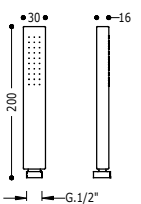

Hand shower Prisma

Anti-limescale nozzles.

Doccino Prisma

Fori anticalcare.

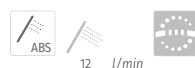

29963108	21,00
----------	-------



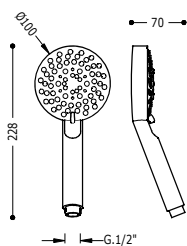

Hand shower L100+

Dimensions: Ø 100 mm. 5 stream types. Anti-limescale nozzles.

Doccino L100+

Dimensioni: Ø 100 mm. 5 tipi di getto. Fori anticalcare.

134748

48,00

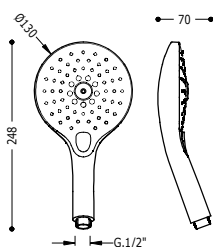
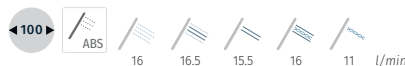

Hand shower D130+

With 3 stream types. Measurements: Ø 130 mm. Anti-limescale nozzles.

Doccino D130+

Con 3 tipi di getto. Misura: Ø 130 mm. Fori anticalcare.

29974904

45,00

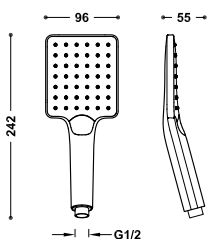

Eco-drop hand shower

With 3 stream types. Measurements: 96x110 mm. Anti-limescale nozzles.

Doccino Eco-drop

Con 3 tipi di getto. Misura: 96x110 mm. Fori anticalcare.

29963113

43,00

29963113NM

67,00

29963113BM

67,00

29963113AC

67,00

29963113KM

67,00

29963113KMB

67,00

29963113OR

95,00

29963113OM

95,00

29963113OP

95,00

29963113OPM

95,00

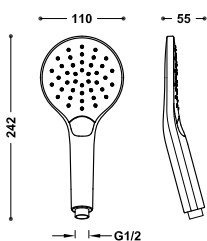

Eco-drop hand shower

With 3 stream types. Measurements: Ø 110 mm. Anti-limescale nozzles.

Doccino Eco-drop

Con 3 tipi di getto. Misura: Ø 110 mm. Fori anticalcare.

29963112

41,00

29963112NM

64,00

29963112BM

64,00

29963112AC

64,00

29963112KM

64,00

29963112KMB

64,00

29963112OR

90,00

29963112OM

90,00

29963112OP

90,00

29963112OPM

90,00

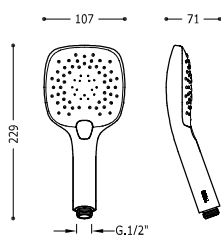

Hand shower Aqua-push

With 3 stream types. Measurements: 107x107 mm. Anti-limescale nozzles.

Doccino Aqua-push

Con 3 tipi di getto. Misura: 107x107 mm. Fori anticalcare.

29974906

39,00

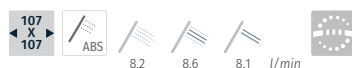

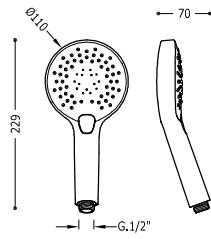

Hand shower Aqua-push

29974905

35,00

With 3 stream types. Measurements: Ø 110 mm. Anti-limescale nozzles.

Doccino Aqua-push

Con 3 tipi di getto. Misura: Ø 110 mm. Fori anticalcare.

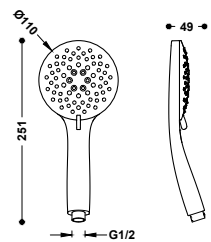
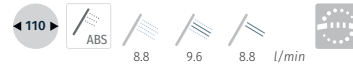

Hand shower R110+

29974901

33,00

With 5 stream types. Measurements: Ø 110 mm. Anti-limescale nozzles.

Doccino R110+

Con 5 tipi di getto. Misura: Ø 110 mm. Fori anticalcare.

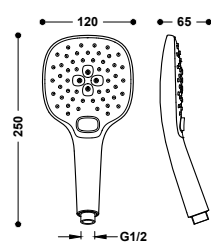

Hand shower Essence

29963111

26,00

Dimensions: 120x120 mm. 3 stream types. Anti-limescale nozzles.

Doccino Essence

Dimensioni: 120x120 mm. 3 tipi di getto. Fori anticalcare.

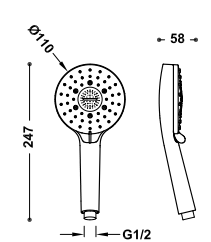
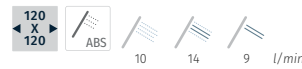

Hand shower Autoclean

29963115

25,00

Dimensions: Ø 110 mm. 5 stream types. Self-cleaning anti-limescale nozzles

Doccino Autoclean

Dimensioni: Ø 110 mm. 5 tipi di getto. Fori anticalcare autopulenti.



**SELF-CLEANING ANTI-LIMESCALE NOZZLES
SOFFIONI ANTICALCARE AUTOPULENTI**

By moving the lever to change the function, the teeth clean each nozzle so there is no limescale build-up.

Quando si cambia la funzione mediante la leva, i dentelli puliscono i fori evitando la formazione del calcare.

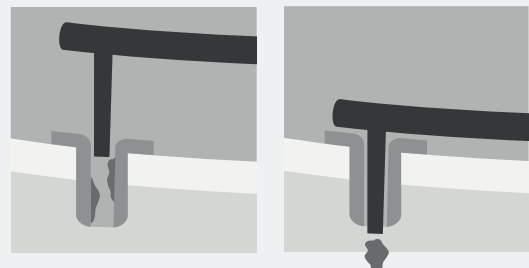

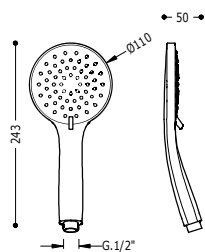

Hand shower D110+

Dimensions: Ø 110 mm. 5 stream types. Anti-limescale nozzles.

Doccino D110+

Dimensioni: Ø 110 mm. 5 tipi di getto. Fori anticalcare.

29963106

25,00

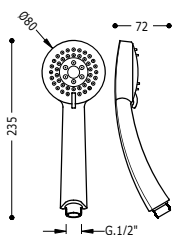
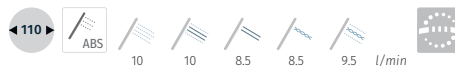

Hand shower D80+

Dimensions: Ø 80 mm. 2 stream types. Anti-limescale nozzles.

Doccino D80+

Dimensioni: Ø 80 mm. 2 tipi di getto. Fori anticalcare.

134627

17,00

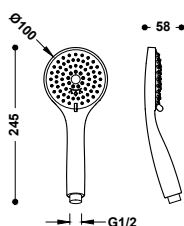

Hand shower D100+

Dimensions: Ø 100 mm. 3 stream types. Anti-limescale nozzles.

Doccino D100+

Dimensioni: Ø 100 mm. 3 tipi di getto. Fori anticalcare.

29963114

16,00

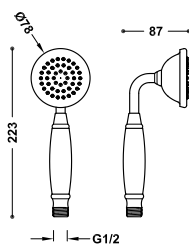
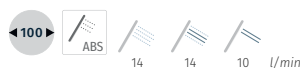

Hand shower Clasic

Ceramic handle. Dimensions: Ø 78 mm. Material: Brass. Anti-limescale nozzles.

Doccino Clasic

Manico in ceramica. Dimensioni: Ø 78 mm. Materiale: Ottone. Fori anticalcare.

29963109

58,00

29963109AC

90,00

29963109OR

145,00

29963109LV

84,00

29963109LM

84,00

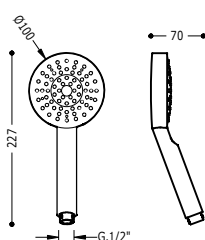

Hand shower L100

Dimensions: Ø 100 mm.

Doccino L100

Dimensioni: Ø 100 mm.

29974802

30,00



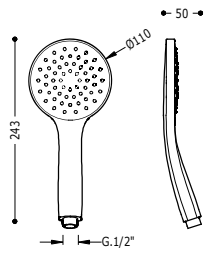

Hand shower D110

Dimensions: Ø 110 mm. Anti-limescale nozzles.

Doccino D110

Dimensioni: Ø 110 mm. Fori anticalcare.

29963105

28,00

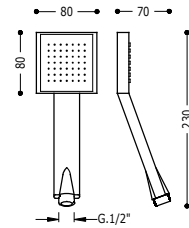

Hand shower Q80

Measurements: 80x80 mm. Anti-limescale nozzles.

Doccino Q80

Misura: 80x80 mm. Fori anticalcare.

134612

18,00

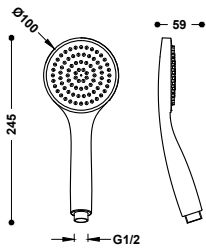

Hand shower D100

Dimensions: Ø 100 mm. Anti-limescale nozzles.

Doccino D100

Dimensioni: Ø 100 mm. Fori anticalcare.

29963110

16,00

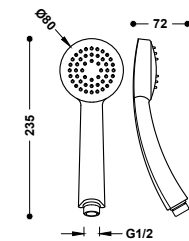

Hand shower D80

Dimensions: Ø 80 mm. Anti-limescale nozzles.

Doccino D80

Dimensioni: Ø 80 mm. Fori anticalcare.

134617

15,00

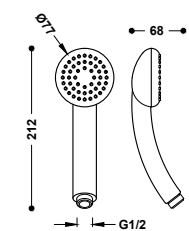

Hand shower Basic

Dimensions: Ø 77 mm. Anti-limescale nozzles.

Doccino Basic

Dimensioni: Ø 77 mm. Fori anticalcare.

9134725

12,00



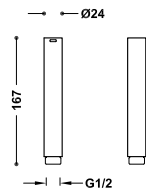

Hand shower for toilet tap

29912390

46,00

With limiter coupling: 5 l/min. For ref.: 00612301, 00612302, 134122, 134123, 181222, 181223, 20522201, 20522301, 28112301.

Doccino per miscelatore wc

Con limitatore: 5 l/min. Per rif.: 00612301, 00612302, 134122, 134123, 181222, 181223, 20522201, 20522301, 28112301.

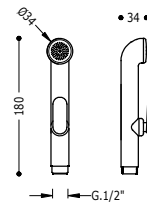

Hand shower with open-close function for WC/bidet concealed mixer

29911351

16,00

With limiter coupling: 8 l/min. For ref.: 181113, 29995001.

Doccino con chiusura per miscelatore wc

Con limitatore: 8 l/min. Per rif.: 181113, 29995001.

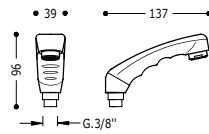

Hand shower for hairdresser tap

9134450

20,00

Doccino per miscelatore parrucchieri



FLEXIBLE HOSES / FLESSIBILI

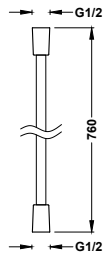

Satin hose

Length: 0.76 m. Diameter: Ø 14.5 mm. Anti-rotation.

Flessibile satinato

Lungh.: 0,76 m. Diametro: Ø 14,5 mm. Flessibile girevole antitorsione.

913460910 21,00

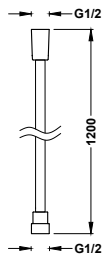

Satin hose

Length: 1.20 m. Diameter: Ø 14.5 mm. Anti-rotation.

Flessibile satinato

Lungh.: 1,20 m. Diametro: Ø 14,5 mm. Flessibile girevole antitorsione.

- 913460912 23,00
- 913460912NM 35,00
- 913460912BM 35,00
- 913460912AC 35,00
- 913460912KM 35,00
- 913460912KMB 35,00
- 913460912OR 51,00
- 913460912OM 51,00
- 913460912OP 51,00
- 913460912OPM 51,00

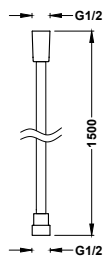

Satin hose

Length: 1.50 m. Diameter: Ø 14.5 mm. Anti-rotation.

Flessibile satinato

Lungh.: 1,50 m. Diametro: Ø 14,5 mm. Flessibile girevole antitorsione.

- 913460915 23,00
- 913460915NM 35,00
- 913460915BM 35,00
- 913460915AC 35,00
- 913460915KM 35,00
- 913460915KMB 35,00
- 913460915OR 51,00
- 913460915OM 51,00
- 913460915OP 51,00
- 913460915OPM 51,00

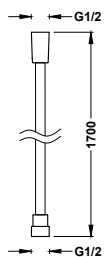

Satin hose

Length: 1.70 m. Diameter: Ø 14.5 mm. Anti-rotation.

Flessibile satinato

Lungh.: 1,70 m. Diametro: Ø 14,5 mm. Flessibile girevole antitorsione.

- 9134609 24,00
- 9134609NM 36,00
- 9134609BM 36,00
- 9134609AC 36,00
- 9134609KM 36,00
- 9134609KMB 36,00
- 9134609OR 52,00
- 9134609OM 52,00
- 9134609OP 52,00
- 9134609OPM 52,00

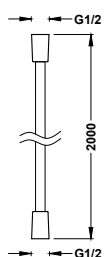

Satin hose

Length: 2.00 m. Diameter: Ø 14.5 mm. Anti-rotation.

Flessibile satinato

Lungh.: 2,00 m. Diametro: Ø 14,5 mm. Flessibile girevole antitorsione.

913460920 24,00



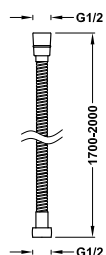

Extendable metal flexible hose

9134630

15,00

Length: 1.70 m and Ø 14 mm. Material: Stainless steel.

Flessibile estensibile in metallo

Lungh.: 1,70 m e Ø 14 mm. Materiale: Acciaio inossidabile.

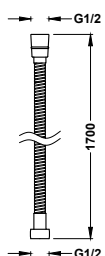

Reinforced metal hose

9134828

18,00

Length: 1.70 m. Conical nut with o-ring and washer in the connection. Ten year guarantee.

Flessibile rinforzato in metallo

Lungh.: 1,70 m. Dado conico con o-ring rondella di sicurezza sul raccordo. Garanzia di dieci anni.

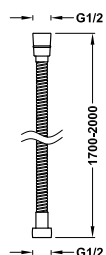

Reinforced and extendable metal flexible hose

913483080

20,00

Length: 1.70 m. Conical nut with o-ring and washer in the connection. Ten year guarantee.

Flessibile in metallo rinforzato ed estensibile

Lungh.: 1,70 m. Dado conico con o-ring rondella di sicurezza sul raccordo. Garanzia di dieci anni.

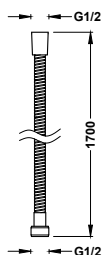

Metal hose

9134830053

82,00

Length: 1.70 m.

9134830054

164,00

Flessibile in metallo

9134830051

82,00

Lungh.: 1,70 m.

913483005LM

82,00

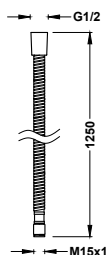

Reinforced metal hose

9134867

33,00

Length: 1.25 m. Diameter: Ø 12 mm. For ref.: 03044401, 03944401, 06944401.

Flessibile rinforzato in metallo

Lungh.: 1,25 m. Diametro: Ø 12 mm. Per rif.: 03044401, 03944401, 06944401.

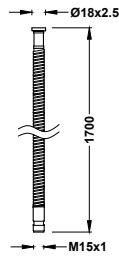

Metal hose

9134712

29,00

Length: 1.70 m. Diameter: Ø 12 mm. For ref.: 114444, 162437, 162438, 181437, 181438, 56243703.

Flessibile in metallo

Lungh.: 1,70 m. Diametro: Ø 12 mm. Per rif.: 114444, 162437, 162438, 181437, 181438, 56243703.

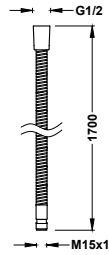

Reinforced metal hose

9134881

33,00

Length: 1.70 m. Conical nut with o-ring and washer in the connection. Ten year guarantee. For ref.: 006161xx, 06116101, 062161xx, 08115001, 08116103, 09286570, 10616102, 10716102, 162161, 163145, 169145, 200162xx, 202161xx, 20266102, 203161xx, 205161xx, 20725207, 20735207, 211161xx, 26215001.

Flessibile rinforzato in metallo

Lungh.: 1,70 m. Dado conico con o-ring rondella di sicurezza sul raccordo. Garanzia di dieci anni. Per rif.: 006161xx, 06116101, 062161xx, 08115001, 08116103, 09286570, 10616102, 10716102, 162161, 163145, 169145, 200162xx, 202161xx, 20266102, 203161xx, 205161xx, 20725207, 20735207, 211161xx, 26215001.

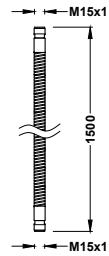

Metal hose

9134731

33,00

Length: 1.50 m. For ref.: 24214501, 24214601, 24214602.

Flessibile in metallo

Lungh.: 1,50 m. Per rif.: 24214501, 24214601, 24214602.

9134731051

82,00

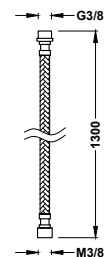

Flexible hose for hairdresser's shower

9134887

35,00

Length: 1.30 m. For ref.: 72450. Material: Black nylon.

Flessibile per doccia parrucchiere

Lungh.: 1,30 m. Per rif.: 72450. Materiale: Nylon nero.

SLIDING BARS / BARRE SCORREVOLI

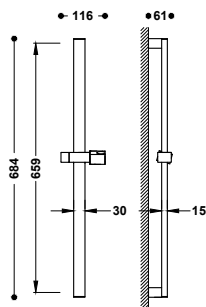

Sliding shower bar

134516

68,00

Brass shower bar: length 659 mm. Adjustable and sliding support for hand shower.

Colonna scorrevole per doccia

Colonna doccia in ottone: lungh. 659 mm. Supporto scorrevole e orientabile per doccia.

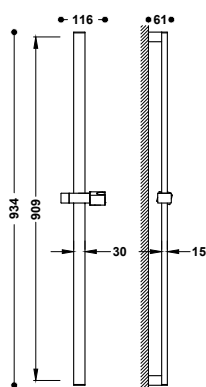

Sliding shower bar

134517

100,00

Brass shower bar: length 909 mm. Adjustable and sliding support for hand shower.

Colonna scorrevole per doccia

Colonna doccia in ottone: lungh. 909 mm. Supporto scorrevole e orientabile per doccia.

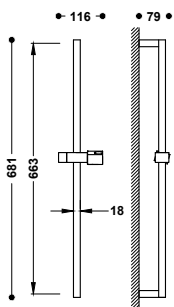

Sliding shower bar

107922

68,00

Brass shower bar: length 663 mm. Adjustable and sliding support for hand shower.

Colonna scorrevole per doccia

Colonna doccia in ottone: lungh. 663 mm. Supporto scorrevole e orientabile per doccia.

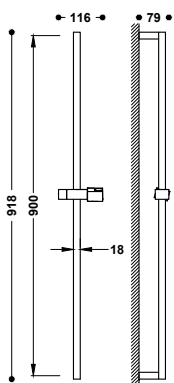

Sliding shower bar

134520

100,00

Brass shower bar: length 900 mm. Adjustable and sliding support for hand shower.

Colonna scorrevole per doccia

Colonna doccia in ottone: lungh. 900 mm. Supporto scorrevole e orientabile per doccia.

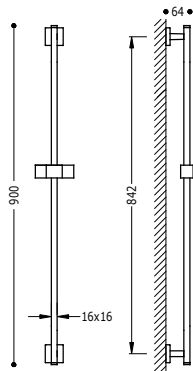

Sliding shower bar

Brass shower bar: length 842 mm. Adjustable and sliding support for hand shower.

Colonna scorrevole per doccia

Colonna doccia in ottone: lungh. 842 mm. Supporto scorrevole e orientabile per doccia.

107935

139,00

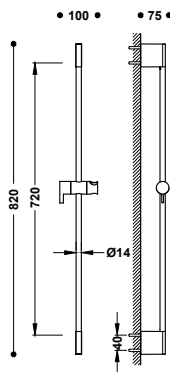

Sliding shower bar

Shower bar: length 820 mm and Ø 14 mm. Adjustable and sliding support for hand shower.

Colonna scorrevole per doccia

Colonna doccia: lungh. 820 mm e Ø 14 mm. Supporto scorrevole e orientabile per doccia.

03463701

86,00

03463701NM

133,00

03463701BM

133,00

03463701AC

133,00

03463701KMB

133,00 **N**

03463701OM

189,00 **N**

03463701OPM

189,00 **N**

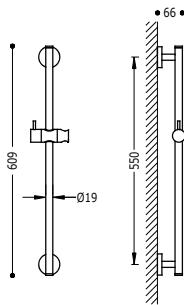

Sliding shower bar

Shower bar: length 550 mm and Ø 19 mm. Adjustable and sliding support for hand shower.

Colonna scorrevole per doccia

Colonna doccia: lungh. 550 mm e Ø 19 mm. Supporto scorrevole e orientabile per doccia.

134618

52,00

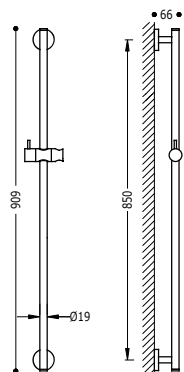

Sliding shower bar

Shower bar: length 850 mm and Ø 19 mm. Adjustable and sliding support for hand shower.

Colonna scorrevole per doccia

Colonna doccia: lungh. 850 mm e Ø 19 mm. Supporto scorrevole e orientabile per doccia.

134619

70,00

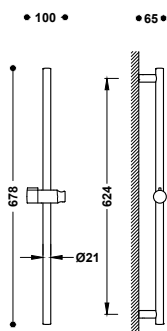

Sliding shower bar

03463702

64,00

Shower bar: length 624 mm and Ø 20.6 mm. Adjustable and sliding support for hand shower.

Colonna scorrevole per doccia

Colonna doccia: lungh. 624 mm e Ø 20.6 mm. Supporto scorrevole e orientabile per doccia.

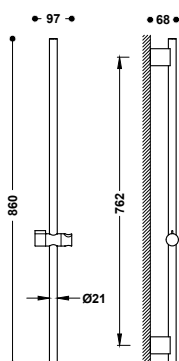

Sliding shower bar

03463708

95,00

Shower bar: length 762 mm and Ø 20.6 mm. Adjustable and sliding support for hand shower.

Colonna scorrevole per doccia

Colonna doccia: lungh. 762 mm e Ø 20,6 mm. Supporto scorrevole e orientabile per doccia.

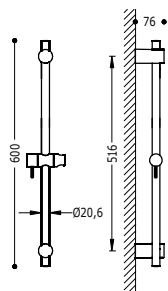

Sliding shower bar

161835

38,00

Shower bar with height-adjustable attachments: length 516 mm and Ø 20.6 mm. Adjustable and sliding support for hand shower.

Colonna scorrevole per doccia

Colonna doccia con attacchi regolabili in altezza: lungh. 516 mm e Ø 20,6 mm. Supporto scorrevole e orientabile per doccia.

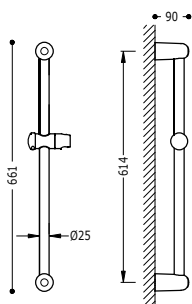

Sliding shower bar

143835

25,00

Shower bar: length 614 mm and Ø 25 mm. Adjustable and sliding support for hand shower.

Colonna scorrevole per doccia

Colonna doccia: lungh. 614 mm e Ø 25 mm. Supporto scorrevole e orientabile per doccia.

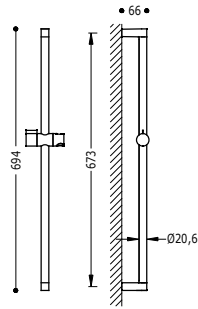

Sliding shower bar

Shower bar: length 673 mm and \varnothing 20.6 mm. Adjustable and sliding support for hand shower.

Colonna scorrevole per doccia

Colonna doccia: lungh. 673 mm e \varnothing 20,6 mm. Supporto scorrevole e orientabile per doccino.

03463706

33,00

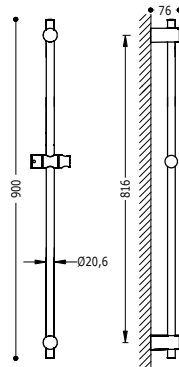

Sliding shower bar

Shower bar with height-adjustable attachments: length 816 mm and \varnothing 20.6 mm. Adjustable and sliding support for hand shower.

Colonna scorrevole per doccia

Colonna doccia con attaches regolabili in altezza: lungh. 816 mm e \varnothing 20,6 mm. Supporto scorrevole e orientabile per doccino.

161838

59,00

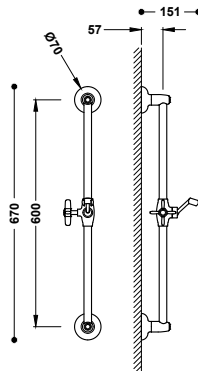

Sliding shower bar

Shower bar: length 600 mm and \varnothing 20.6 mm. Adjustable and sliding support for hand shower.

Colonna scorrevole per doccia

Colonna doccia: lungh. 600 mm e \varnothing 20,6 mm. Supporto scorrevole e orientabile per doccino.

24273201

216,00

24273201AC

335,00

24273201LV

313,00

24273201LM

313,00

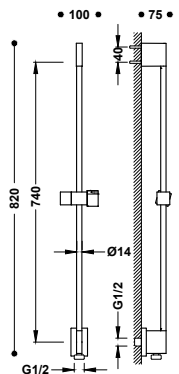

Sliding shower bar with wall water supply

Shower bar: 740 mm and \varnothing 14 mm. Adjustable and sliding support for hand shower.

Colonna scorrevole per doccia con presa d'acqua a muro

Colonna doccia: 740 mm e \varnothing 14 mm. Supporto scorrevole e orientabile per doccino.

03493299

149,00

03493299NM

231,00

03493299BM

231,00

03493299AC

231,00

03493299KMB

231,00 **N**

03493299OM

328,00 **N**

03493299OPM

328,00 **N**



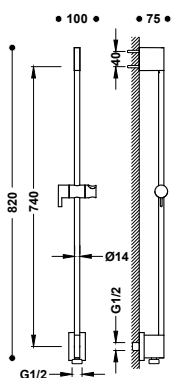

Sliding shower bar with wall water supply

Shower bar: 740 mm and Ø 14 mm. Adjustable and sliding support for hand shower.

Colonna scorrevole per doccia con presa d'acqua a muro

Colonna doccia: 740 mm e Ø 14 mm. Supporto scorrevole e orientabile per doccino.

03493199	142,00
03493199NM	220,00
03493199BM	220,00
03493199AC	220,00
03493199KMB	220,00 N
03493199OM	312,00 N
03493199OPM	312,00 N

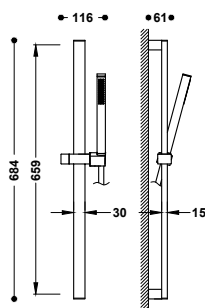

Shower bar set

Brass shower bar: length 659 mm. Adjustable and sliding support for hand shower. Anti-limescale brass hand shower. Satin hose.

Kit colonna doccia

Colonna doccia in ottone: lungh. 659 mm. Supporto scorrevole e orientabile per doccino. Doccino anticalcare in ottone. Flessibile satinato.

03452602	118,00
----------	--------

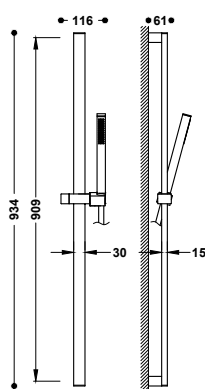

Shower bar set

Brass shower bar: length 909 mm. Adjustable and sliding support for hand shower. Anti-limescale brass hand shower. Satin hose.

Kit colonna doccia

Colonna doccia in ottone: lungh. 909 mm. Supporto scorrevole e orientabile per doccino. Doccino anticalcare in ottone. Flessibile satinato.

03452702	155,00
----------	--------

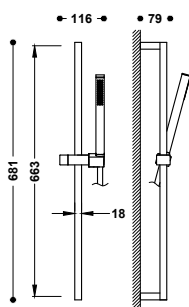

Shower bar set

Brass shower bar: length 663 mm. Adjustable and sliding support for hand shower. Anti-limescale brass hand shower. Satin hose.

Kit colonna doccia

Colonna doccia in ottone: lungh. 663 mm. Supporto scorrevole e orientabile per doccino. Doccino anticalcare in ottone. Flessibile satinato.

03433603	118,00
----------	--------



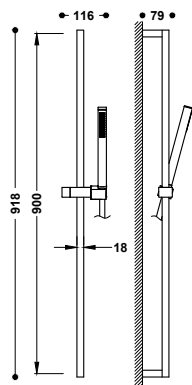

Shower bar set

03433604

155,00

Brass shower bar: length 900 mm. Adjustable and sliding support for hand shower. Anti-limescale brass hand shower. Satin hose.

Kit colonna doccia

Colonna doccia in ottone: lungh. 900 mm. Supporto scorrevole e orientabile per doccia. Doccino anticalcare in ottone. Flessibile satinato.

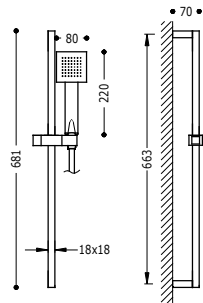

Shower bar set

134512

105,00

Brass shower bar: length 663 mm. Adjustable and sliding support for hand shower. Anti-limescale hand shower. Satin hose.

Kit colonna doccia

Colonna doccia in ottone: lungh. 663 mm. Supporto scorrevole e orientabile per doccia. Doccino anticalcare. Flessibile satinato.

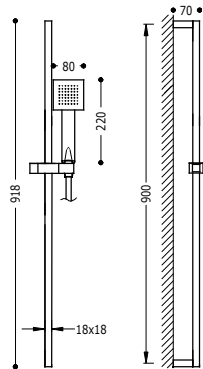

Shower bar set

134522

141,00

Brass shower bar: length 900 mm. Adjustable and sliding support for hand shower. Anti-limescale hand shower. Satin hose.

Kit colonna doccia

Colonna doccia in ottone: lungh. 900 mm. Supporto scorrevole e orientabile per doccia. Doccino anticalcare. Flessibile satinato.

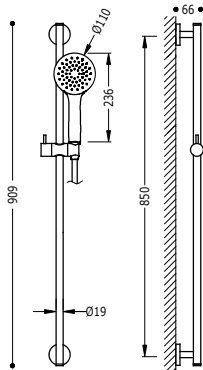

Shower bar set

06192801

115,00

Shower bar: length 850 mm and Ø 19 mm. Adjustable and sliding support for hand shower. Anti-limescale hand shower. Satin hose.

Kit colonna doccia

Colonna doccia: lungh. 850 mm e Ø 19 mm. Supporto scorrevole e orientabile per doccia. Doccino anticalcare. Flessibile satinato.



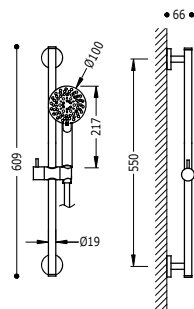

Shower bar set

134628

122,00

Shower bar: length 550 mm and Ø 19 mm. Adjustable and sliding support for hand shower. Anti-limescale hand shower: Ø 100 mm. (5 stream types). Satin hose.

Kit colonna doccia

Colonna doccia: lungh. 550 mm e Ø 19 mm. Supporto scorrevole e orientabile per doccia. Doccino anticalcare: Ø 100 mm. (5 tipi di getto). Flessibile satinato.

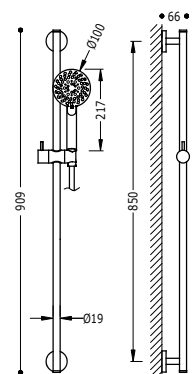
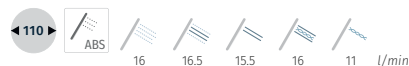

Shower bar set

134629

137,00

Shower bar: length 850 mm and Ø 19 mm. Adjustable and sliding support for hand shower. Anti-limescale hand shower: Ø 100 mm. (5 stream types). Satin hose.

Kit colonna doccia

Colonna doccia: lungh. 850 mm e Ø 19 mm. Supporto scorrevole e orientabile per doccia. Doccino anticalcare: Ø 100 mm. (5 tipi di getto). Flessibile satinato.

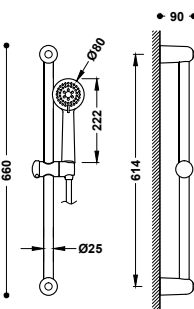
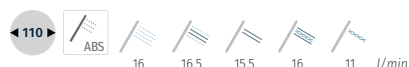

Shower bar set

143836

63,00

Shower bar: length 614 mm and Ø 25 mm. Adjustable and sliding support for hand shower. Anti-limescale: Ø 80 mm hand shower. (2 stream types). Satin hose.

Kit colonna doccia

Colonna doccia: lungh. 614 mm e Ø 25 mm. Supporto scorrevole e orientabile per doccia. Doccino anticalcare: Ø 80 mm. (2 tipi di getto). Flessibile satinato.

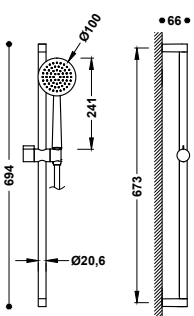

Shower bar set

03463709

67,00

Shower bar: length 673 mm and Ø 20,6 mm. Adjustable and sliding support for hand shower. Anti-limescale hand shower. Satin hose.

03463709NM

104,00

Kit colonna doccia

Colonna doccia: lungh. 673 mm e Ø 20,6 mm. Supporto scorrevole e orientabile per doccia. Doccino anticalcare. Flessibile satinato.



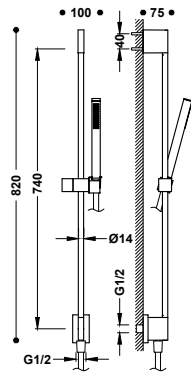

Shower bar set with wall water supply

Shower bar: 820 mm and Ø 14 mm. Adjustable and sliding support for hand shower. Anti-limescale brass hand shower. Satin hose.

Set di colonna doccia con presa d'acqua a muro

Colonna doccia: 820 mm e Ø 14 mm. Supporto scorrevole e orientabile per doccino. Doccino anticalcare in ottone. Flessibile satinato.

03493201	204,00
03493201NM	316,00
03493201BM	316,00
03493201AC	316,00

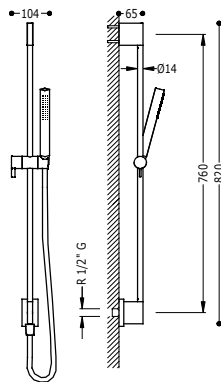

Shower bar set with wall water supply

Shower bar: 760 mm and Ø 14 mm. Adjustable and sliding support for hand shower. Anti-limescale brass hand shower. Satin hose.

Set di colonna doccia con presa d'acqua a muro

Colonna doccia: 760 mm e Ø 14 mm. Supporto scorrevole e orientabile per doccino. Doccino anticalcare in ottone. Flessibile satinato.

03493101	197,00
03493101NM	305,00
03493101BM	305,00
03493101AC	305,00

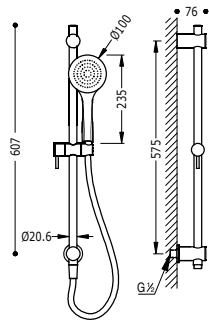

Shower bar set with wall water supply

Support for hand shower with wall water supply. Shower bar: length 575 mm and Ø 20.6 mm. Adjustable and sliding support for hand shower. Anti-limescale hand shower. Satin hose.

Set di colonna doccia con presa d'acqua a muro

Supporto con presa d'acqua a muro. Colonna doccia: lungh. 575 mm e Ø 20,6 mm. Supporto scorrevole e orientabile per doccino. Doccino anticalcare. Flessibile satinato.

06193103	131,00
----------	--------

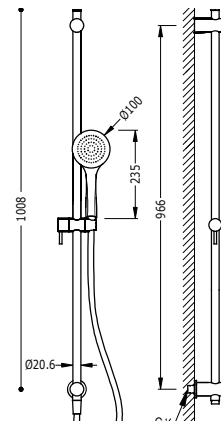

Shower bar set with wall water supply

Support for hand shower with wall water supply. Shower bar: length 966 mm and Ø 20.6 mm. Adjustable and sliding support for hand shower. Anti-limescale hand shower. Satin hose.

Set di colonna doccia con presa d'acqua a muro

Supporto con presa d'acqua a muro. Colonna doccia: lungh. 966 mm e Ø 20,6 mm. Supporto scorrevole e orientabile per doccino. Doccino anticalcare. Flessibile satinato.

06193105	151,00
----------	--------



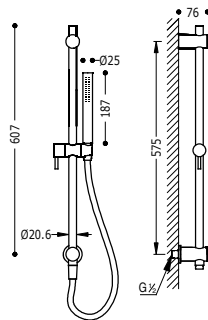

Shower bar set with wall water supply

06193102 134,00

Support for hand shower with wall water supply. Shower bar: length 575 mm and Ø 20.6 mm. Adjustable and sliding support for hand shower. Anti-limescale brass hand shower. Satin hose.

Set di colonna doccia con presa d'acqua a muro

Supporto con presa d'acqua a muro. Colonna doccia: lungh. 575 mm e Ø 20,6 mm. Supporto scorrevole e orientabile per doccia. Doccino anticalcare in ottone. Flessibile satinato.

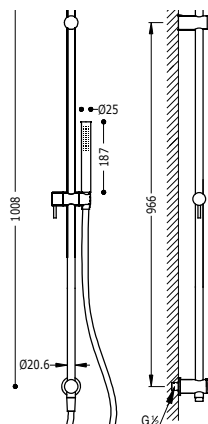

Shower bar set with wall water supply

06193104 155,00

Support for hand shower with wall water supply. Shower bar: length 966 mm and Ø 20.6 mm. Adjustable and sliding support for hand shower. Anti-limescale brass hand shower. Satin hose.

Set di colonna doccia con presa d'acqua a muro

Supporto con presa d'acqua a muro. Colonna doccia: lungh. 966 mm e Ø 20,6 mm. Supporto scorrevole e orientabile per doccia. Doccino anticalcare in ottone. Flessibile satinato.

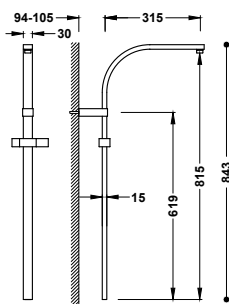

Shower bar adaptable to thermostatic wall tap with compatible connection

- 03463506 144,00
- 03463506NM 223,00
- 03463506BM 223,00
- 03463506AC 223,00
- 03463506KMB 223,00
- 03463506OM 317,00
- 03463506OPM 317,00

To complete with the rest of the shower parts.

Colonna per doccia adattabile a miscelatore termostatico a muro con raccordo compatibile

Da completare con gli altri elementi della doccia.

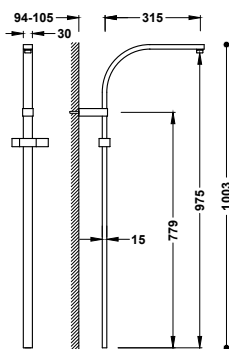

Long shower bar adaptable to thermostatic wall tap with compatible connection

- 03463505 154,00
- 03463505NM 239,00
- 03463505BM 239,00
- 03463505AC 239,00
- 03463505KMB 239,00
- 03463505OM 339,00
- 03463505OPM 339,00

To complete with the rest of the shower parts.

Colonna lunga per doccia adattabile a miscelatore termostatico a muro con raccordo compatibile

Da completare con gli altri elementi della doccia.

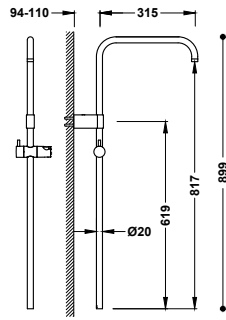



Shower bar adaptable to thermostatic wall tap with compatible connection

To complete with the rest of the shower parts.

Colonna per doccia adattabile a miscelatore termostatico a muro con raccordo compatibile

Da completare con gli altri elementi della doccia.

	03463502	104,00
	03463502NM	161,00
	03463502BM	161,00
	03463502AC	161,00
	03463502KMB	161,00
	03463502OM	229,00
	03463502OPM	229,00

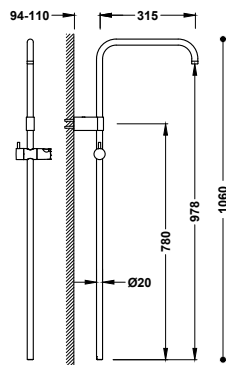





Long shower bar adaptable to thermostatic wall tap with compatible connection

To complete with the rest of the shower parts.

Colonna lunga per doccia adattabile a miscelatore termostatico a muro con raccordo compatibile

Da completare con gli altri elementi della doccia.

	03463501	114,00
	03463501NM	177,00
	03463501BM	177,00
	03463501AC	177,00
	03463501KMB	177,00
	03463501OM	251,00
	03463501OPM	251,00

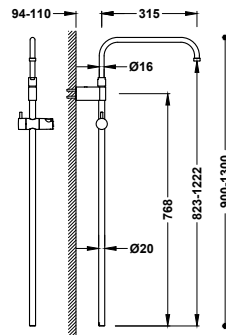







Telescopic shower bar adaptable to thermostatic wall tap with compatible connection

To complete with the rest of the shower parts.

Colonna doccia telescopica adattabile a miscelatore termostatico a muro con raccordo compatibile

Da completare con gli altri elementi della doccia.

	03464501	145,00
	03464501NM	225,00
	03464501BM	225,00
	03464501AC	225,00
	03464501KMB	225,00
	03464501OM	319,00
	03464501OPM	319,00

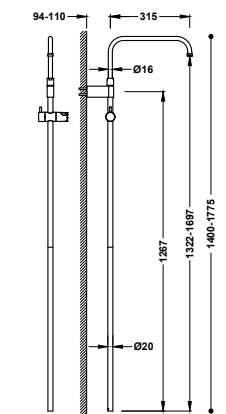

Telescopic shower bar adaptable to thermostatic wall tap with compatible connection

To complete with the rest of the shower parts.

Colonna doccia telescopica adattabile a miscelatore termostatico a muro con raccordo compatibile

Da completare con gli altri elementi della doccia.

	03464502	160,00
---	----------	--------



SHOWER KITS / KIT PER DOCCIA

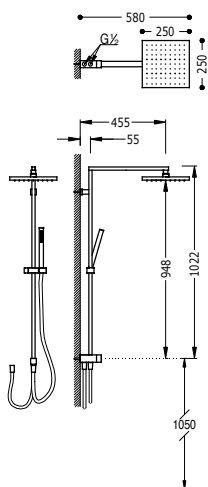

Shower set adjustable to any tap type

107476

378,00

- With diverter integrated into the shower bar.
- Stainless steel adjustable shower head: 250x250 mm.
- Adjustable and sliding support for hand shower.
- Anti-limescale brass hand shower.
- Satin hose.

Set doccia adattabile a qualsiasi miscelatore

- Con inverter incorporato nella colonna doccia.
- Soffione doccia orientabile in acciaio inossidabile: 250x250 mm.
- Supporto scorrevole e orientabile per doccia.
- Doccino anticalcare in ottone.
- Flessibile satinato.

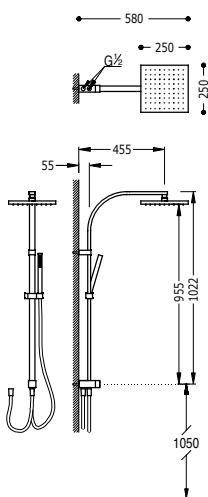

Shower set adjustable to any tap type

107926

375,00

- With diverter integrated into the shower bar.
- Stainless steel adjustable shower head: 250x250 mm.
- Adjustable and sliding support for hand shower.
- Anti-limescale brass hand shower.
- Satin hose.

Set doccia adattabile a qualsiasi miscelatore

- Con inverter incorporato nella colonna doccia.
- Soffione doccia orientabile in acciaio inossidabile: 250x250 mm.
- Supporto scorrevole e orientabile per doccia.
- Doccino anticalcare in ottone.
- Flessibile satinato.

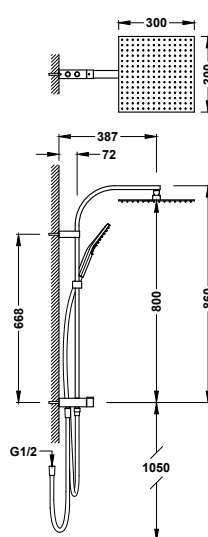

Shower set adjustable to any tap type

19063504

349,00

- With diverter integrated into the shower bar.
- Stainless steel adjustable shower head: 300x300 mm.
- Adjustable and sliding support for hand shower.
- Anti-limescale hand showers: 96x110 mm. (3 stream types).
- Satin hose.

Set doccia adattabile a qualsiasi miscelatore

- Con inverter incorporato nella colonna doccia.
- Soffione doccia orientabile in acciaio inossidabile: 300x300 mm.
- Supporto scorrevole e orientabile per doccia.
- Doccino anticalcare: 96x110 mm. (3 tipi di getto).
- Flessibile satinato.



19063504NM

540,00

19063504BM

540,00

19063504AC

540,00

19063504OM

767,00

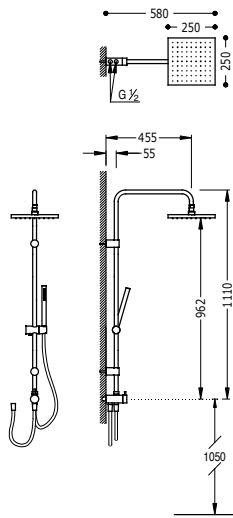

Shower set adjustable to any tap type

06163506 336,00

- With diverter integrated into the shower bar.
- Stainless steel adjustable shower head: 250x250 mm.
- Adjustable and sliding support for hand shower.
- Anti-limescale brass hand shower.
- Satin hose.

Set doccia adattabile a qualsiasi miscelatore

- Con inverter incorporato nella colonna doccia.
- Soffione doccia orientabile in acciaio inossidabile: 250x250 mm.
- Supporto scorrevole e orientabile per doccia.
- Doccino anticalcare in ottone.
- Flessibile satinato.

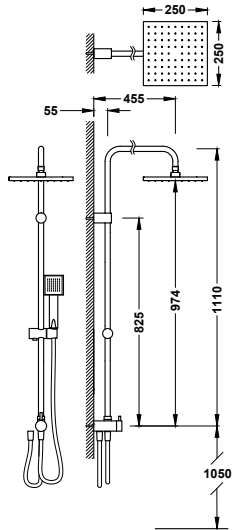

Shower set adjustable to any tap type

20047501 252,00

- With diverter integrated into the shower bar.
- Adjustable shower head: 250x250 mm.
- Adjustable and sliding support for hand shower.
- Anti-limescale hand showers: 80x80 mm.
- Reinforced metal hose.

Set doccia adattabile a qualsiasi miscelatore

- Con inverter incorporato nella colonna doccia.
- Soffione doccia orientabile: 250x250 mm.
- Supporto scorrevole e orientabile per doccia.
- Doccino anticalcare: 80x80 mm.
- Flessibile rinforzato in metallo.

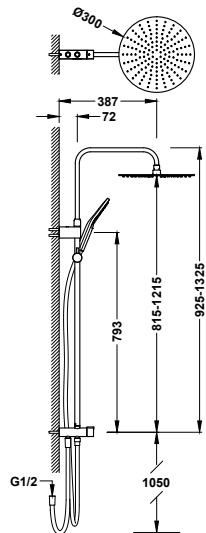
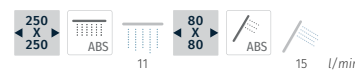

Shower set adjustable to any tap type

19063502 362,00

- With diverter integrated into the shower bar.
- Stainless steel adjustable shower head: Ø 300 mm.
- Adjustable and sliding support for hand shower.
- Anti-limescale hand showers: Ø 110 mm. (3 stream types).
- Satin hose.

Set doccia adattabile a qualsiasi miscelatore

- Con inverter incorporato nella colonna doccia.
- Soffione doccia orientabile in acciaio inossidabile: Ø 300 mm.
- Supporto scorrevole e orientabile per doccia.
- Doccino anticalcare: Ø 110 mm. (3 tipi di getto).
- Flessibile satinato.

19063502NM 561,00

19063502BM 561,00

19063502KMB 561,00

19063502OM 797,00

19063502OPM 797,00



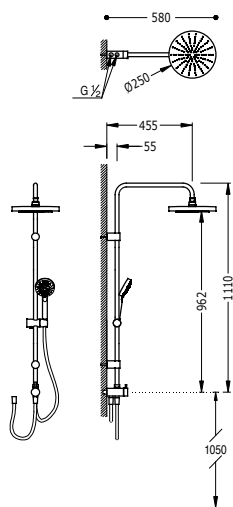

Shower set adjustable to any tap type

161214

315,00

- With diverter integrated into the shower bar.
- Stainless steel adjustable shower head: Ø 250 mm.
- Adjustable and sliding support for hand shower.
- Anti-limescale hand showers: Ø 100 mm. (5 stream types).
- Satin hose.

Set doccia adattabile a qualsiasi miscelatore

- Con inverter incorporato nella colonna doccia.
- Soffione doccia orientabile in acciaio inossidabile: Ø 250 mm.
- Supporto scorrevole e orientabile per doccino.
- Doccino anticalcare: Ø 100 mm. (5 tipi di getto).
- Flessibile satinato.

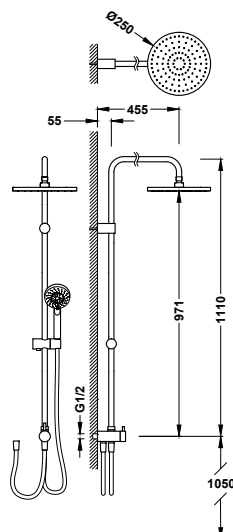

Shower set adjustable to any tap type

161475

257,00

- With diverter integrated into the shower bar.
- Stainless steel adjustable shower head: Ø 250 mm.
- Adjustable and sliding support for hand shower.
- Anti-limescale hand showers: Ø 100 mm. (5 stream types).
- Satin hose.

Set doccia adattabile a qualsiasi miscelatore

- Con inverter incorporato nella colonna doccia.
- Soffione doccia orientabile in acciaio inossidabile: Ø 250 mm.
- Supporto scorrevole e orientabile per doccino.
- Doccino anticalcare: Ø 100 mm. (5 tipi di getto).
- Flessibile satinato.

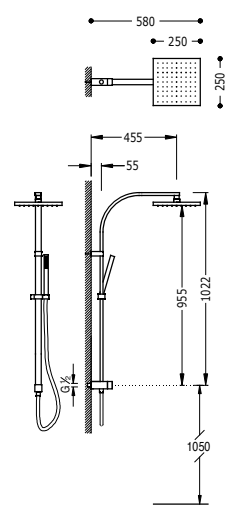

Shower bar set without mixer tap with water supply and shower head

107131

373,00

- With diverter integrated into the shower bar.
- Stainless steel adjustable shower head: 250x250 mm.
- Adjustable and sliding support for hand shower.
- Anti-limescale brass hand shower.
- Satin hose.

Set di colonna doccia senza miscelatore con presa d'acqua e soffione

- Con inverter incorporato nella colonna doccia.
- Soffione doccia orientabile in acciaio inossidabile: 250x250 mm.
- Supporto scorrevole e orientabile per doccino.
- Doccino anticalcare in ottone.
- Flessibile satinato.



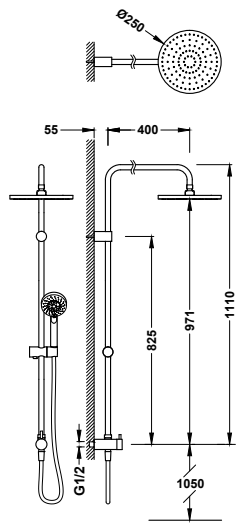

Shower bar set without mixer tap with water supply and shower head

06163505 255,00

- With diverter integrated into the shower bar.
- Stainless steel adjustable shower head: \varnothing 250 mm.
- Adjustable and sliding support for hand shower.
- Anti-limescale hand showers: \varnothing 100 mm. (5 stream types).
- Satin hose.

Set di colonna doccia senza miscelatore con presa d'acqua e soffione

- Con inverter incorporato nella colonna doccia.
- Soffione doccia orientabile in acciaio inossidabile: \varnothing 250 mm.
- Supporto scorrevole e orientabile per doccino.
- Doccino anticalcare: \varnothing 100 mm. (5 tipi di getto).
- Flessibile satinato.

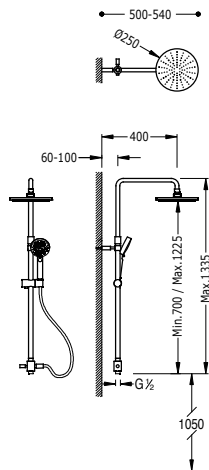

Shower bar set without mixer tap with water supply and shower head

161213 342,00

- With diverter integrated into the shower bar.
- Telescopic shower bar.
- Stainless steel adjustable shower head: \varnothing 250 mm.
- Adjustable and sliding support for hand shower.
- Anti-limescale hand showers: \varnothing 100 mm. (5 stream types).
- Satin hose.

Set di colonna doccia senza miscelatore con presa d'acqua e soffione

- Con inverter incorporato nella colonna doccia.
- Colonna doccia telescopica.
- Soffione doccia orientabile in acciaio inossidabile: \varnothing 250 mm.
- Supporto scorrevole e orientabile per doccino.
- Doccino anticalcare: \varnothing 100 mm. (5 tipi di getto).
- Flessibile satinato.

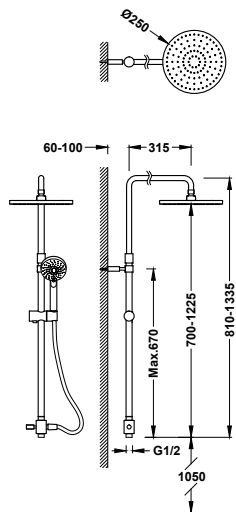

Shower bar set without mixer tap with water supply and shower head

06163509 310,00

- With diverter integrated into the shower bar.
- Telescopic shower bar.
- Stainless steel adjustable shower head: \varnothing 250 mm.
- Adjustable and sliding support for hand shower.
- Anti-limescale hand showers: \varnothing 100 mm.
- Satin hose.

Set di colonna doccia senza miscelatore con presa d'acqua e soffione

- Con inverter incorporato nella colonna doccia.
- Colonna doccia telescopica.
- Soffione doccia orientabile in acciaio inossidabile: \varnothing 250 mm.
- Supporto scorrevole e orientabile per doccino.
- Doccino anticalcare: \varnothing 100 mm.
- Flessibile satinato.



STEERABLE SUPPORTS / SUPPORTI ORIENTABILI

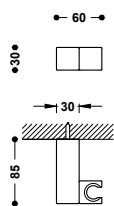





Adjustable support for hand shower

Material: Brass

Supporto orientabile per doccia

Materiale: Ottone

	107839	31,00
	107839NM	48,00
	107839BM	48,00
	50783903	48,00
	107839OR	68,00
	107839OM	68,00

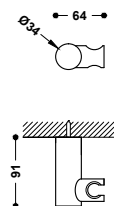









Adjustable support for hand shower

Material: Brass

Supporto orientabile per doccia

Materiale: Ottone

	161839	29,00
	06183901NM	45,00
	06183901BM	45,00
	06183901AC	45,00
	06183901KM	45,00
	06183901KMB	45,00
	06183901OR	64,00
	06183901OM	64,00
	06183901OPM	64,00

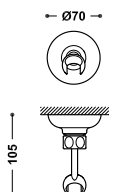

Adjustable support for hand shower

Material: Brass.

Supporto orientabile per doccia

Materiale: Ottone.

	29963910	40,00
	29963910AC	62,00
	29963910OR	88,00
	29963910LV	58,00
	29963910LM	58,00

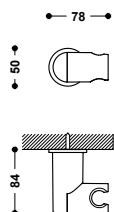

Adjustable support for hand shower

	29963901	10,00
---	----------	-------

Supporto orientabile per doccia

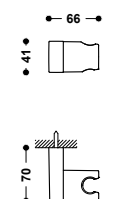

Adjustable support for hand shower

	29963928	7,00
---	----------	------

Supporto orientabile per doccia

Fixed support for hand shower

9134841

10,00

Supporto fisso per doccia



Articulated support with 3 positions for hand shower

134215023

7,00

Supporto articolato a 3 posizioni per doccia

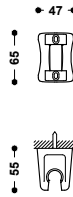

SUPPORTS WITH WALL CONNECTION / SUPPORTO CON PRESA A MURO

Fixed support with water supply for hand shower and hose

Non-return valve. With impact protection. Material: Brass.

Supporto fisso con presa d'acqua per doccia e flessibile

Valvola di ritegno. Con protezione antiurto. Materiale: Ottone.

20718221

75,00

20718221NM

116,00

20718221BM

116,00

20718221AC

116,00

20718221OR

165,00

20718221OM

165,00

20718221OPM

165,00

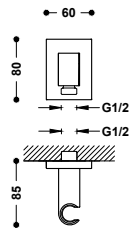

N

Fixed support with water supply for hand shower and hose

Non-return valve. With impact protection.

Supporto fisso con presa d'acqua per doccia e flessibile

Valvola di ritegno. Con protezione antiurto.

20218221

48,00

20218221NM

74,00

20218221BM

74,00

20218221AC

74,00

20218221OR

106,00

20218221OM

106,00

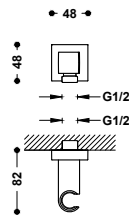

N

Fixed support with water supply for hand shower and hose

Non-return valve. With impact protection.

Supporto fisso con presa d'acqua per doccia e flessibile

Valvola di ritegno. Con protezione antiurto.

21118221

45,00

21118221NM

70,00

21118221BM

70,00

21118221AC

70,00

21118221KM

70,00

21118221KMB

70,00

21118221OR

99,00

21118221OM

99,00

21118221OP

99,00

21118221OPM

99,00

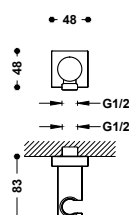

N





Fixed support with water supply for hand shower and hose
 Non-return valve. With impact protection.
Supporto fisso con presa d'acqua per doccia e flessibile
 Valvola di ritegno. Con protezione antiurto.

26118221	42,00
26118221NM	65,00
26118221BM	65,00
26118221AC	65,00
26118221KM	65,00
26118221KMB	65,00
26118221OR	92,00
26118221OM	92,00
26118221OP	92,00
26118221OPM	92,00

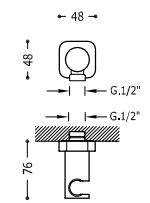

N

Fixed support with water supply for hand shower and hose
 Non-return valve.
Supporto fisso con presa d'acqua per doccia e flessibile
 Valvola di ritegno.

20018201	55,00
20018201NM	85,00
20018201BM	85,00
20018201AC	85,00
20018201OR	120,00
20018201OM	120,00



Fixed support with water supply for hand shower and hose
 Non-return valve. With impact protection.
Supporto fisso con presa d'acqua per doccia e flessibile
 Valvola di ritegno. Con protezione antiurto.

21618221	44,00
----------	-------



N





Fixed support with water supply for hand shower and hose
 Non-return valve. With impact protection.
Supporto fisso con presa d'acqua per doccia e flessibile
 Valvola di ritegno. Con protezione antiurto.

21518221	42,00
----------	-------

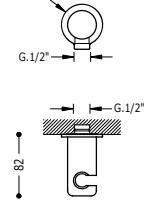

N

Fixed support with water supply for hand shower and hose
 Non-return valve.
Supporto fisso con presa d'acqua per doccia e flessibile
 Valvola di ritegno.

02418201	50,00
----------	-------



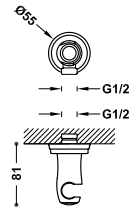



Fixed support with water supply for hand shower and hose

With wall water supply.

Supporto fisso con presa d'acqua per doccino e flessibile

Con presa d'acqua a muro.

	24218201	71,00
	24218201AC	111,00
	24218201OR	157,00
	24218201LV	104,00
	24218201LM	104,00

WALL ELBOW ADAPTORS / ADATTATORE A GOMITO A MURO

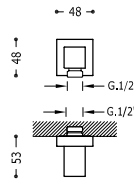

Elbow with wall connection for hose

With G1/2" wall water supply.

Gomito con presa a muro per flessibile.

Con presa d'acqua a muro G1/2".

	00618301	63,00
	00618301NM	98,00 N

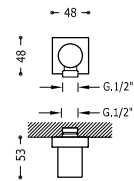

Elbow with wall connection for hose

With G1/2" wall water supply.

Gomito con presa a muro per flessibile.

Con presa d'acqua a muro G1/2".

	06118301	35,00
---	----------	-------

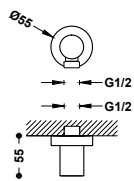

Elbow with wall connection for hose

With G1/2" wall water supply.

Gomito con presa a muro per flessibile.

Con presa d'acqua a muro G1/2".

	20518301	35,00
	20518301NM	55,00 N

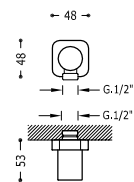

Elbow with wall connection for hose

With G1/2" wall water supply.

Gomito con presa a muro per flessibile.

Con presa d'acqua a muro G1/2".

	20018301	35,00
---	----------	-------



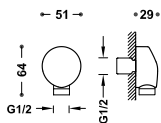

Elbow with wall connection for hose

With G1/2" wall water supply.

Gomito con presa a muro per flessibile.

Con presa d'acqua a muro G1/2".

134757

23,00

JETS / GETTI

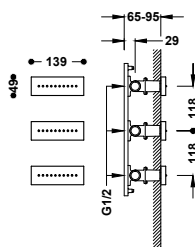

3 concealed hydromassage jets

With installation profile included. Material: Brass. Measurements: 139x49 mm.

3 getti idromassaggio a incasso

Con profilo di montaggio incluso. Materiale: Ottone. Misura: 139x49 mm.

29951504

693,00

29951504NM

1.074,00

29951504BM

1.074,00

29951504AC

1.074,00

29951504OR

1.525,00

29951504OM

1.525,00

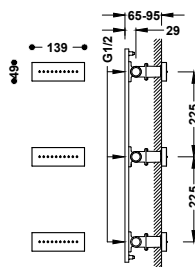

3 concealed hydromassage jets

With installation profile included. Material: Brass. Measurements: 139x49 mm.

3 getti idromassaggio a incasso

Con profilo di montaggio incluso. Materiale: Ottone. Misura: 139x49 mm.

29951505

709,00

29951505NM

1.099,00

29951505BM

1.099,00

29951505AC

1.099,00

29951505OR

1.559,00

29951505OM

1.559,00

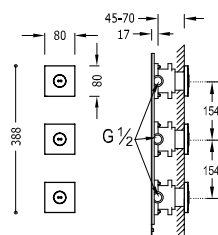

3 concealed rotating hydromassage jets

With installation profile included. Measurements: 80x80 mm.

3 getti idromassaggio rotanti incassati

Con profilo di montaggio incluso. Misura: 80x80 mm.

29951506

420,00

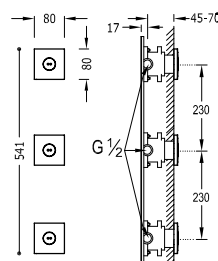

3 concealed rotating hydromassage jets

With installation profile included. Measurements: 80x80 mm.

3 getti idromassaggio rotanti incassati

Con profilo di montaggio incluso. Misura: 80x80 mm.

29951507

436,00



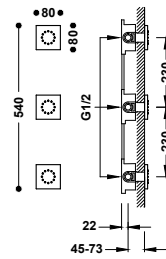

3 concealed hydromassage jets

With installation profile included. Measurements: 80x80 mm.

3 getti idromassaggio a incasso

Con profilo di montaggio incluso. Misura: 80x80 mm.



	13451501	473,00
	13451501NM	732,00
	13451501BM	732,00
	13451501AC	732,00
	13451501KM	732,00
	13451501KMB	732,00
	13451501OR	1.040,00
	13451501OM	1.040,00
	13451501OP	1.040,00
	13451501OPM	1.040,00

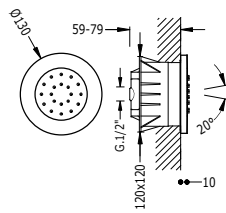

Concealed hydromassage jet

With adjustable shower head. 1 stream type. Includes an anti-lime system, non-return valve and flow limiter: 5 l/min.

Getto idromassaggio a incasso

Con supporto orientabile. 1 tip di getto. Include un sistema anticalcare, valvola di ritegno e limitatore di flusso: 5 l/min.



	9161515	129,00
---	---------	--------

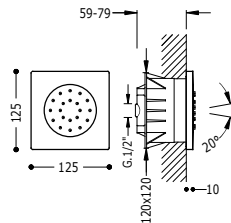

Concealed hydromassage jet

With adjustable shower head. 1 stream type. Includes an anti-lime system, non-return valve and flow limiter: 5 l/min.

Getto idromassaggio a incasso

Con supporto orientabile. 1 tip di getto. Include un sistema anticalcare, valvola di ritegno e limitatore di flusso: 5 l/min.



	9107515	134,00
---	---------	--------

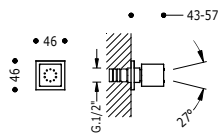

Hydromassage jet

With adjustable shower head. 1 stream type. Includes an anti-lime system, non-return valve and flow limiter: 5 l/min. Material: Brass.

Getto idromassaggio

Con supporto orientabile. 1 tip di getto. Include un sistema anticalcare, valvola di ritegno e limitatore di flusso: 5 l/min. Materiale: Ottone.



	9134515	60,00
---	---------	-------

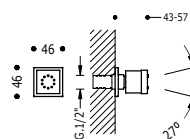

Hydromassage jet

With adjustable shower head. 1 stream type. Includes an anti-lime system, non-return valve and flow limiter: 5 l/min. Material: Brass.

Getto idromassaggio

Con supporto orientabile. 1 tip di getto. Include un sistema anticalcare, valvola di ritegno e limitatore di flusso: 5 l/min. Materiale: Ottone.



	29951501	63,00
---	----------	-------



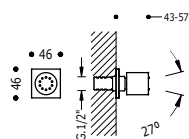

Hydromassage jet

29951503

55,00

With adjustable shower head. 1 stream type. Includes an anti-lime system, non-return valve and flow limiter: 5 l/min. Material: Brass.

Getto idromassaggio

Con supporto orientabile. 1 tip di getto. Include un sistema anticalcare, valvola di ritegno e limitatore di flusso: 5 l/min. Materiale: Ottone.

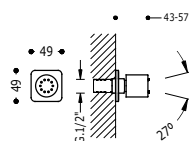

Hydromassage jet

29951502

56,00

With adjustable shower head. 1 stream type. Includes an anti-lime system, non-return valve and flow limiter: 5 l/min. Material: Brass.

Getto idromassaggio

Con supporto orientabile. 1 tip di getto. Include un sistema anticalcare, valvola di ritegno e limitatore di flusso: 5 l/min. Materiale: Ottone.

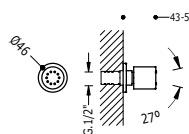

Hydromassage jet

9134415

45,00

With adjustable shower head. 1 stream type. Includes an anti-lime system, non-return valve and flow limiter: 5 l/min. Material: Brass.

Getto idromassaggio

Con supporto orientabile. 1 tip di getto. Include un sistema anticalcare, valvola di ritegno e limitatore di flusso: 5 l/min. Materiale: Ottone.

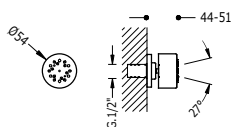

Hydromassage jet

9134915

36,00

With adjustable shower head. 2 stream types. Water flow: 6 l/min and 4.5 l/min.

Getto idromassaggio

Con supporto orientabile. 2 tipi di getto. Flusso: 6 l/min e 4.5 l/min.

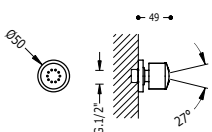

Hydromassage jet

9134615

29,00

With adjustable shower head. 1 stream type. Water flow: 4 l/min.

Getto idromassaggio

Con supporto orientabile. 1 tip di getto. Flusso: 4 l/min.





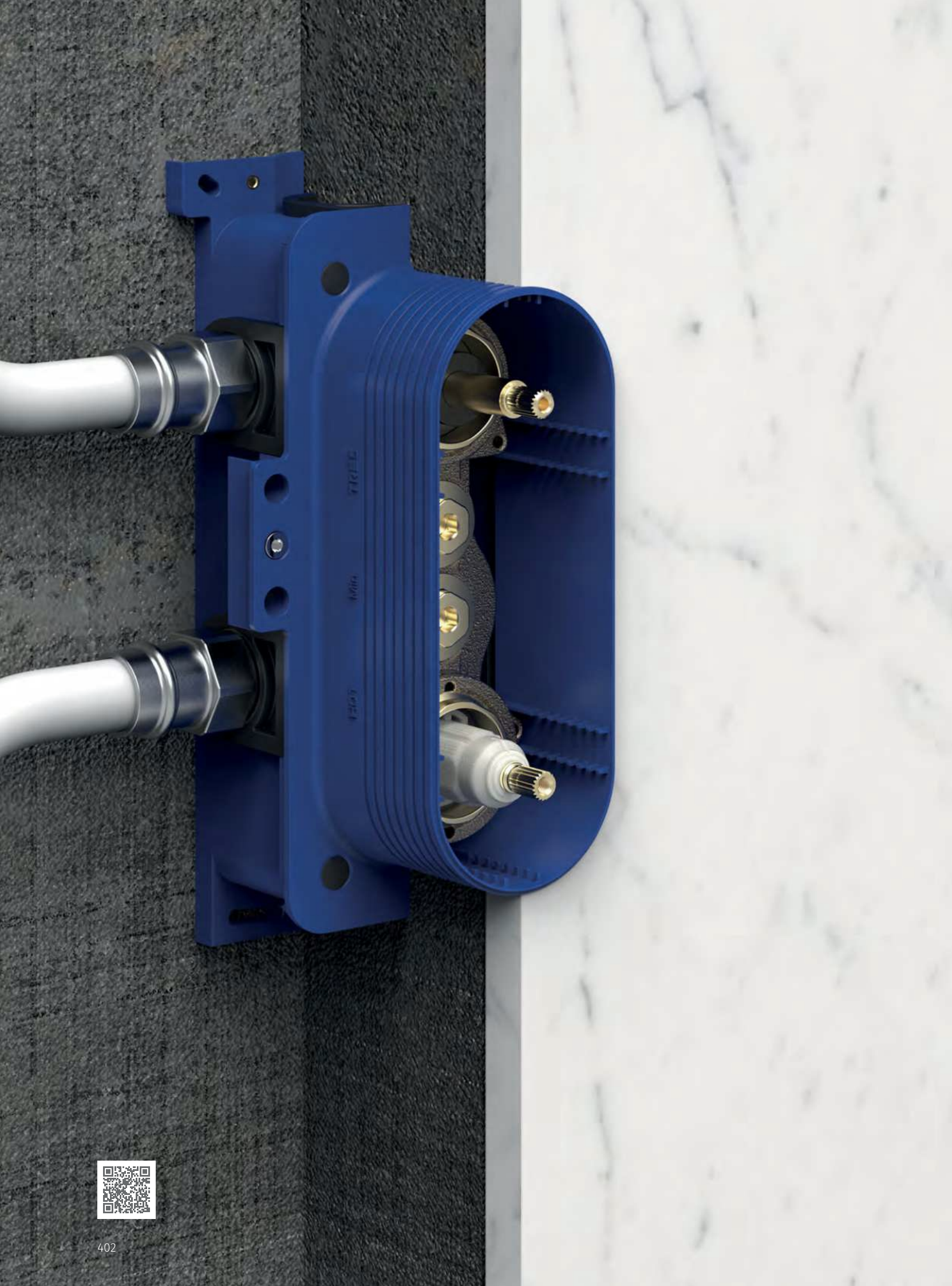

CONCEALED SOLUTIONS

SOLUZIONI A INCASSO



- 404 For floor installation of mixers
Per montaggio di miscelatori a pavimento

- 405 For wall-mounted sink taps
Per Rubinetti a parete da lavello

- 405 Rapid-box

- 405 Therm-box

- 406 Tank for bath edge tapware
Contenitore per kit di miscelazione bordo vasca

FOR FLOOR INSTALLATION OF MIXERS / PER MONTAGGIO DI MISCELATORI A PAVIMENTO

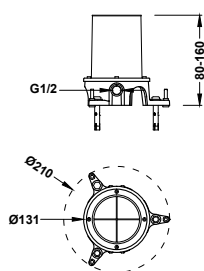

Concealing base for floor installation of single-handle mixer taps

26285350

189,00

Concealed part only.

Base a incasso per montaggio di miscelatori monocomando a pavimento

Solo parte da incasso.



Buy separately

You can install the concealed box first before buying the visible part once everything is ready. This helps you simplify your project and save time.

Acquista separatamente

Puoi installare la scatola incassata e, successivamente, acquistare la parte a vista per installarla quando tutto è pronto. In questo modo la pianificazione del lavoro risulta semplificata ed efficiente.

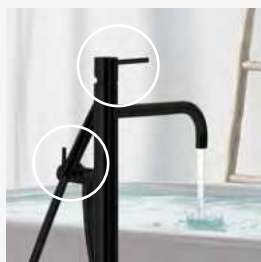

Two separate regulators, one to fill the bath and the other for the hand shower.

Due regolatori indipendenti, uno per il riempimento della vasca e l'altro per la doccia.



The concealed body is hidden under the floor. It requires **80 mm minimum** and 160 mm maximum space.

Il corpo incassato è nascosto sotto il pavimento e necessita solo di uno spazio minimo di 80 mm e massimo di 160 mm.

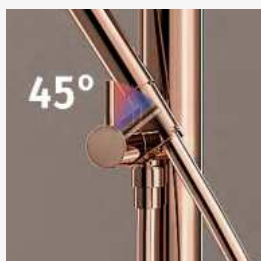

The **temperature** of the shower regulator is limited to prevent burns. (Flow of 7 l/min).

La temperatura del regolatore della doccia è limitata per evitare scottature. (Portata di 7 l/min).



The body is completely **waterproof**, preventing filtration of water and protecting against moisture.

Il corpo completamente a tenuta stagna impedisce all'acqua di penetrare e protegge dall'umidità.



The bath outlet permits a higher temperature to **maintain more hot water** inside the bathtub. (Flow of 22 l/min).

L'uscita per la vasca consente una temperatura più elevata per poter mantenere più acqua calda all'interno della vasca. (Portata di 22 l/min).



If the tap is not **correctly aligned** after it has been installed, the direction of the spout can be redressed when fastening the tap.

Una volta installato il rubinetto, se non è correttamente allineato, c'è la possibilità di rettificare l'orientamento del getto durante il fissaggio del rubinetto.

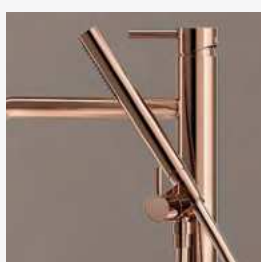

Tilted shower stand to **prevent dripping onto the floor** when turning the tap on or off.

Supporto della doccia inclinato per evitare il gocciolamento sul pavimento quando apriamo o chiudiamo il rubinetto.



The concealed body can also be **levelled** during installation to correct uneven floors.

Il corpo da incasso può anche essere livellato durante la posa per rettificare le irregolarità del pavimento.

FOR WALL-MOUNTED SINK TAPS / PER RUBINETTI A PARETE DA LAVELLO

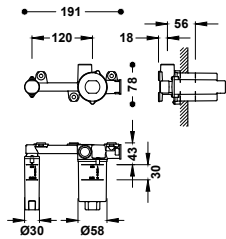

Recessed body for sink tap

20830002

85,00

Indivisible recessed body with acoustic dampeners and damp-proof seal.

Corpo a incasso per rubinetto da lavello

Corpo a incasso indivisibile insonorizzato con ammortizzatori e provvisto di guarnizione anti-umidità.



RAPID-BOX

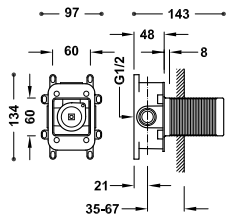

Concealed 1-way Rapid-box with single-handle mixer tap for shower

20827810

80,00

Concealed body with acoustic buffers. ABS embedding box. Anti-moisture seal.

Scatola da incasso a 1 via Rapid-box con miscelatore monocomando per doccia

Corpo incassato con smorzatori acustici. Scatola da incasso in ABS. Guarnizione antiumidità.

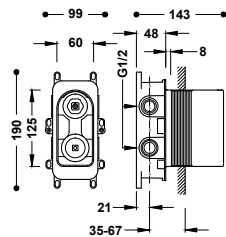

Concealed 2-way Rapid-box with single-handle mixer tap for shower and bath

20828110

90,00

Concealed body with acoustic buffers. ABS embedding box. Anti-moisture seal. 2-way ceramic distributor.

Scatola da incasso a 2 vie Rapid-box con miscelatore monocomando per doccia e vasca da bagno

Corpo incassato con smorzatori acustici. Scatola da incasso in ABS. Guarnizione antiumidità. Erogatore in ceramica a 2 getti.

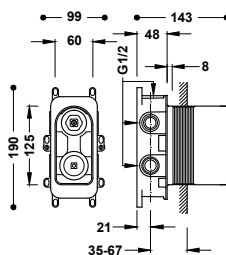

Concealed 3-way Rapid-box with single-handle mixer tap for shower and bath

20827310

95,00

Concealed body with acoustic buffers. ABS embedding box. Anti-moisture seal. 3-way ceramic distributor.

Scatola da incasso a 3 vie Rapid-box con miscelatore monocomando per doccia e vasca da bagno

Corpo incassato con smorzatori acustici. Scatola da incasso in ABS. Guarnizione antiumidità. Erogatore in ceramica a 3 getti.



THERM-BOX

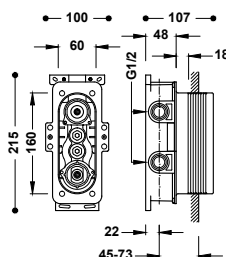

Therm-box 2-way concealed box with thermostatic tap for shower and bathtub

20785001

130,00

Concealed body with acoustic buffers. ABS embedding box. Anti-moisture seal. 2-way ceramic distributor.

Scatola da incasso a 2 getti Therm-box con miscelatore termostatico per doccia e vasca da bagno

Corpo incassato con smorzatori acustici. Scatola da incasso in ABS. Guarnizione antiumidità. Erogatore in ceramica a 2 getti.



TANK FOR BATH EDGE TAPWARE / CONTENITORE PER KIT DI MISCELAZIONE BORDO VASCA

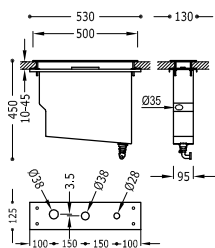

Tank for bath edge tapware

Easy upper installation. Without inspection points. For ref.: 20216103, 20216101.

Contenitore per kit di miscelazione bordo vasca

Facile montaggio superiore. Senza chiusino. Per rif.: 20216103, 20216101.

	20224501	415,00
	20224501NM	643,00 N
	20224501BM	643,00 N
	20224501AC	643,00 N
	20224501OR	912,00 N
	20224501OM	912,00 N

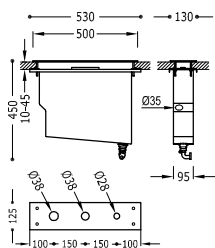

Tank for bath edge tapware

Easy upper installation. Without inspection points. For ref.: 006161xx, 006161xx 205161xx.

Contenitore per kit di miscelazione bordo vasca

Facile montaggio superiore. Senza chiusino. Per rif.: 006161xx, 006161xx 205161xx.

	20024501	415,00
	20024501NM	643,00 N
	20024501BM	643,00 N
	20024501AC	518,00 N
	20024501KM	643,00 N
	20024501KMB	643,00 N
	20024501OR	912,00 N
	20024501OM	912,00 N
	20024501OP	912,00 N
	20024501PM	912,00 N

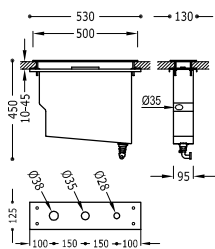

Tank for bath edge tapware

Easy upper installation. Without inspection points. For ref.: 10716102, 10616102.

Contenitore per kit di miscelazione bordo vasca

Facile montaggio superiore. Senza chiusino. Per rif.: 10716102, 10616102.

	106245	415,00
--	--------	--------

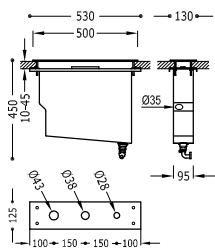

Tank for bath edge tapware

Easy upper installation. Without inspection points. For ref.: 200162xx, 203161xx, 062161xx.

Contenitore per kit di miscelazione bordo vasca

Facile montaggio superiore. Senza chiusino. Per rif.: 200162xx, 203161xx, 062161xx.

	20324501	415,00
	20324501NM	643,00 N
	20324501BM	643,00 N
	20324501AC	643,00 N
	20324501OR	912,00 N
	20324501OM	912,00 N

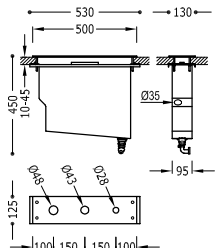

Tank for bath edge tapware

Easy upper installation. Without inspection points. For ref.: 26215001, 162161.

Contenitore per kit di miscelazione bordo vasca

Facile montaggio superiore. Senza chiusino. Per rif.: 26215001, 162161.

	162245	415,00
--	--------	--------

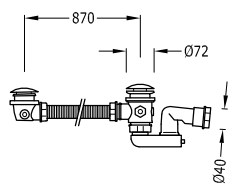

Click-clack drainage valve for bath with overflow and drainage point

134445

100,00

With water drainage point for tank kit. Plug Ø 72 mm.

Valvola di scarico Click-clack per vasca con troppopieno e presa drenaggio

Con presa drenaggio acqua per kit contenitore. Tappo: Ø 72 mm.





ACCESSORIES

ACCESSORI

- 410 Square
Quadrato
- 411 Round
Rotondo
- 412 Classic
Classico
- 413 Packs
Packs
- 413 Soap dispenser
Dispenser di sapone
- 413 Shut-off valves
Valvole di intercettazione



SQUARE / QUADRATO

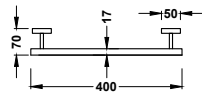

Towel rail
400 mm.

Portasciugamani
400 mm.

	10723601	65,00
	10723601NM	101,00
	10723601BM	101,00
	10723601AC	101,00
	10723601KM	101,00
	10723601KMB	101,00
	10723601OR	143,00
	10723601OM	143,00
	10723601OP	143,00
	10723601OPM	143,00

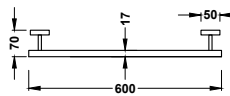

Towel rail
600 mm.

Portasciugamani
600 mm.

	10723603	68,00
	10723603NM	106,00
	10723603BM	106,00
	10723603AC	106,00
	10723603KM	106,00
	10723603KMB	106,00
	10723603OR	150,00
	10723603OM	150,00
	10723603OP	150,00
	10723603OPM	150,00

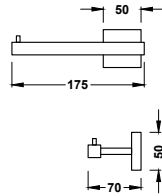

Toilet paper holder without cover

Portarotolo senza coperchio

	10723606	32,00
	10723606NM	50,00
	10723606BM	50,00
	10723606AC	50,00
	10723606KM	50,00
	10723606KMB	50,00
	10723606OR	83,00
	10723606OM	83,00
	10723606OP	83,00
	10723606OPM	83,00

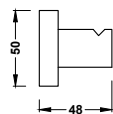

Robe hook

Gancio

	10723620	28,00
	10723620NM	43,00
	10723620BM	43,00
	10723620AC	43,00
	10723620KM	43,00
	10723620KMB	43,00
	10723620OR	62,00
	10723620OM	62,00
	10723620OP	62,00
	10723620OPM	62,00

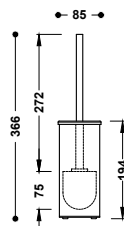

Floor toilet brush holder

Portascopino da appoggio



	10733605	77,00
	10733605NM	119,00
	10733605BM	119,00
	10733605AC	119,00
	10733605KM	119,00
	10733605KMB	119,00
	10733605OR	231,00
	10733605OM	231,00
	10733605OP	231,00
	10733605OPM	231,00

ROUND / ROTONDO

Towel rail

480 mm.

Portasciugamani

480 mm.

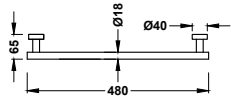

	16123601	60,00
	16123601NM	93,00
	16123601BM	93,00
	16123601AC	93,00
	16123601KM	93,00
	16123601KMB	93,00
	16123601OR	132,00
	16123601OM	132,00
	16123601OP	132,00
	16123601OPM	132,00

Towel rail

580 mm.

Portasciugamani

580 mm.

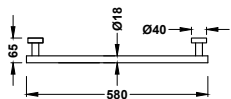

	16123602	63,00
	16123602NM	98,00
	16123602BM	98,00
	16123602AC	98,00
	16123602KM	98,00
	16123602KMB	98,00
	16123602OR	139,00
	16123602OM	139,00
	16123602OP	139,00
	16123602OPM	139,00

Toilet paper holder without cover

Portarotolo senza coperchio

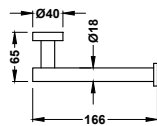

	16123606	30,00
	16123606NM	47,00
	16123606BM	47,00
	16123606AC	47,00
	16123606KM	47,00
	16123606KMB	47,00
	16123606OR	90,00
	16123606OM	90,00
	16123606OP	90,00
	16123606OPM	90,00

Grab bar

306 mm.

Maniglia di sostegno per vasca

306 mm.

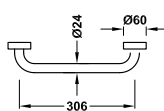

	134184	39,00
	134184NM	60,00
	134184BM	60,00
	134184AC	60,00
	134184KM	60,00
	134184KMB	60,00
	134184OR	100,00
	134184OM	100,00
	134184OP	100,00
	134184OPM	100,00

Robe hook

Gancio

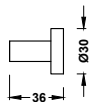

	16123620	18,00
	16123620NM	28,00
	16123620BM	28,00
	16123620AC	28,00
	16123620KM	28,00
	16123620KMB	28,00
	16123620OR	40,00
	16123620OM	40,00
	16123620OP	40,00
	16123620OPM	40,00

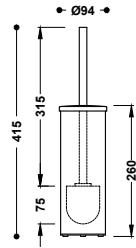

Floor toilet brush holder

Portascopino da appoggio



	16133602	72,00
	16133602NM	112,00
	16133602BM	112,00
	16133602AC	112,00
	16133602KM	112,00
	16133602KMB	112,00
	16133602OR	216,00
	16133602OM	216,00
	16133602OP	216,00
	16133602OPM	216,00

CLASSIC / CLASSICO

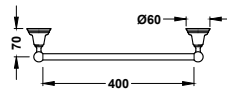

Towel rail

400 mm.

Portasciugamani

400 mm.

	12423601	78,00
	12423601AC	121,00
	12423601OR	172,00
	12423601LV	113,00
	12423601LM	113,00

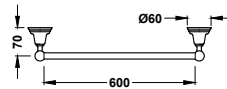

Towel rail

600 mm.

Portasciugamani

600 mm.

	12423603	82,00
	12423603AC	127,00
	12423603OR	180,00
	12423603LV	119,00
	12423603LM	119,00

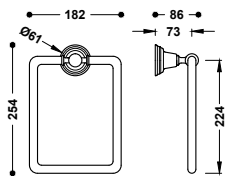

Square towel ring

Portasciugamani ad anello quadrato

	12463609	80,00
	02463609AC	121,00
	02463609OR	172,00
	5246360951	113,00
	02463609LM	113,00

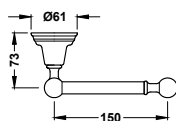





Toilet paper holder without cover

Portarotolo senza coperchio

	12423606	52,00
	12423606AC	81,00
	12423606OR	114,00
	12423606LV	75,00
	12423606LM	75,00

Robe hook

	12423607	22,00
	12423607AC	34,00
	12423607OR	48,00
	12423607LV	32,00
	12423607LM	32,00

Gancio

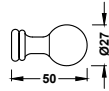

PACKS / PACKS

Set of 2 towel rails + 1 Toilet paper holder without cover + 1 Robe hook

Towel rail 400 mm. Towel rail 600 mm.

Set di 2 portasciugamani + 1 Portarotolo senza coperchio + 1 Gancio

Portasciugamani 400 mm. Portasciugamani 600 mm.

	09598101	183,00
	09598101NM	290,00
	09598101BM	290,00
	09598101AC	290,00
	09598101KM	290,00
	09598101KMB	290,00
	09598101OR	411,00
	09598101OM	411,00
	09598101OP	411,00
	09598101OPM	411,00



Set of 2 towel rails + 1 Toilet paper holder without cover + 1 Robe hook

Towel rail 480 mm. Towel rail 580 mm.

Set di 2 portasciugamani + 1 Portarotolo senza coperchio + 1 Gancio

Portasciugamani 480 mm. Portasciugamani 580 mm.

	09598102	166,00
	09598102NM	257,00
	09598102BM	257,00
	09598102AC	257,00
	09598102KM	257,00
	09598102KMB	257,00
	09598102OR	365,00
	09598102OM	365,00
	09598102OP	365,00
	09598102OPM	365,00







SOAP DISPENSERS / DISPENSER DI SAPONE

Soap dispenser built into the counter

For counter tops or sinks. Capacity: 0.4 litres. Material: Metal.

Dispenser di sapone a incasso da appoggio

Per ripiani o lavelli. Capacità: 0,4 litri. Materiale: Metallo.

	13474110	24,00
	13474110NM	37,00
	13474110BM	37,00
	13474110AC	37,00
	13474110OM	53,00

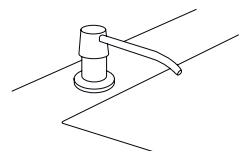
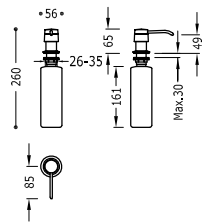







SHUT-OFF VALVES / VALVOLE DI INTERCETTAZIONE

Concealed shut-off valve

Female thread connection: 1/2".

Valvola di intercettazione a incasso

Attacco a filetto femmina: 1/2".

	00715501	89,00
	00715501NM	137,00
	00715501BM	137,00
	00715501AC	137,00
	00715501OR	196,00
	00715501OM	196,00

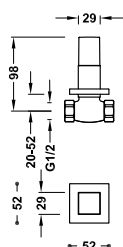

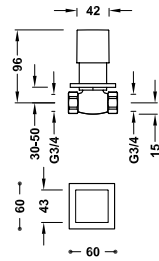

Concealed shut-off valve

Female thread connection: 3/4".

Valvola di intercettazione a incasso

Attacco a filetto femmina: 3/4".

107511

96,00

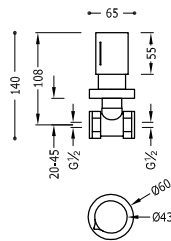

Concealed shut-off valve

Female thread connection: 1/2".

Valvola di intercettazione a incasso

Attacco a filetto femmina: 1/2".

- 06115501 83,00
- 06115501NM 128,00
- 06115501BM 128,00
- 06115501AC 128,00
- 06115501KM 128,00
- 06115501KMB 128,00
- 06115501OR 182,00
- 06115501OM 182,00
- 06115501OP 182,00
- 06115501OPM 182,00

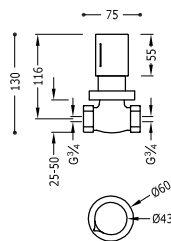

Concealed shut-off valve

Female thread connection: 3/4".

Valvola di intercettazione a incasso

Attacco a filetto femmina: 3/4".

- 06151101 91,00
- 06151101NM 140,00
- 06151101BM 140,00
- 06151101AC 140,00
- 06151101KM 140,00
- 06151101KMB 140,00
- 06151101OR 199,00
- 06151101OM 199,00
- 06151101OP 199,00
- 06151101OPM 199,00

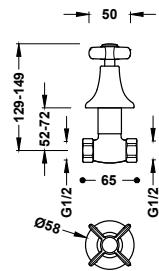

Concealed shut-off valve

With G1/2 threaded connection. Ceramic index (cold).

Valvola di intercettazione a incasso

Con attacco filettato da G1/2. Indicatore in ceramica (freddo).

- 24215501 93,00
- 24215501AC 145,00
- 24215501OR 206,00
- 24215501LV 136,00
- 24215501LM 136,00

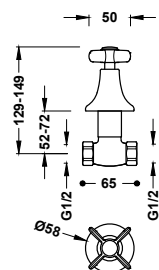

Concealed shut-off valve

With G1/2 threaded connection. Ceramic index (hot).

Valvola di intercettazione a incasso

Con attacco filettato da G1/2. Indicatore in ceramica (caldo).

- 24215502 93,00
- 24215502AC 145,00
- 24215502OR 206,00
- 24215502LV 136,00
- 24215502LM 136,00





ELECTRONIC TECHNOLOGY

TECNOLOGIA ELETTRONICA

- 419 Wash basins
Lavabi
- 425 Soap dispensers
Dispenser di sapone
- 426 WC sensors
Sensori WC
- 426 Hand dryer
Asciuga mani
- 427 Kitchen electronic tap
Cucina elettronica







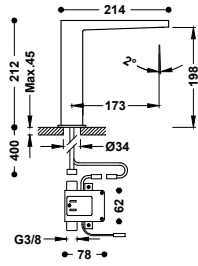



ELECTRONIC TAPS WITH 1 WATER OUTLET / RUBINETTI ELETTRONICI MONOACQUA



Electronic washbasin tap with 1 water outlet
Operated by infrared sensor.

Rubinetto elettronico monoacqua per lavabo
Azionato mediante sensore a infrarossi.

	20261310	357,00
	20261310NM	553,00
	20261310BM	553,00
	20261310AC	553,00
	20261310OR	785,00
	20261310OM	785,00

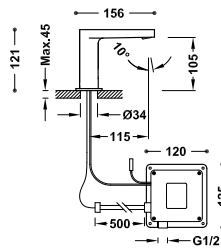

Electronic washbasin tap with 1 water outlet
Operated by infrared sensor.

Rubinetto elettronico monoacqua per lavabo
Azionato mediante sensore a infrarossi.

	20560301	310,00
---	----------	--------

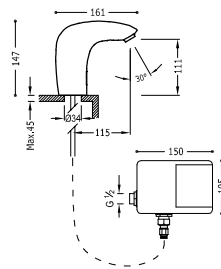

Electronic washbasin tap with 1 water outlet
Operated by infrared sensor.

Rubinetto elettronico monoacqua per lavabo
Azionato mediante sensore a infrarossi.

	19260603	305,00
--	----------	--------

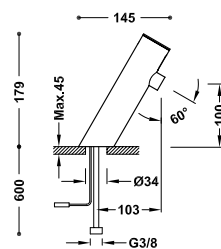

Electronic washbasin tap with 1 water outlet
Operated by infrared sensor. Water flow: 6 l/m.

Rubinetto elettronico monoacqua per lavabo
Azionato mediante sensore a infrarossi. Flusso: 6 l/m.

	39210302	163,00
---	----------	--------

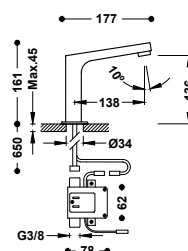

Electronic washbasin tap with 1 water outlet
Operated by infrared sensor.

Rubinetto elettronico monoacqua per lavabo
Azionato mediante sensore a infrarossi.

	39210317	209,00
---	----------	--------



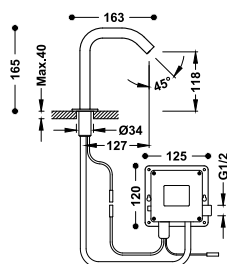

Electronic washbasin tap with 1 water outlet

39210303

315,00

Operated by infrared sensor.

Rubinetto elettronico monoacqua per lavabo

Azionato mediante sensore a infrarossi.

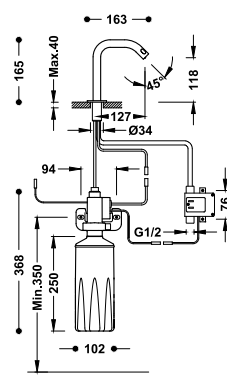

Electronic washbasin tap with 1 water outlet and automatic soap dispenser

39210304

420,00

Operated by infrared sensor. Soap tank capacity: 1600 ml.

Miscelatore elettronico monoacqua con dispenser di sapone automatico per lavabo

Azionato mediante sensore a infrarossi. Capacità del dosatore di sapone: 1600 ml.

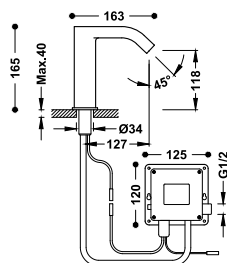

Electronic washbasin tap with 1 water outlet

39210305

399,00

Operated by infrared sensor.

Rubinetto elettronico monoacqua per lavabo

Azionato mediante sensore a infrarossi.

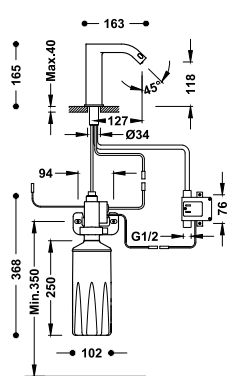

Electronic washbasin tap with 1 water outlet and automatic soap dispenser

39210306

504,00

Operated by infrared sensor. Soap tank capacity: 1600 ml.

Miscelatore elettronico monoacqua con dispenser di sapone automatico per lavabo

Azionato mediante sensore a infrarossi. Capacità del dosatore di sapone: 1600 ml.



Electronic washbasin tap with 1 water outlet

39210319

410,00

Operated by infrared sensor.

Rubinetto elettronico monoacqua per lavabo

Azionato mediante sensore a infrarossi.

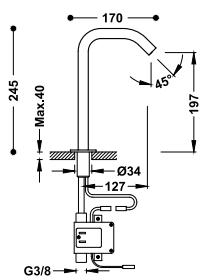

Electronic washbasin tap with 1 water outlet and automatic soap dispenser

39210320

515,00

Operated by infrared sensor. Soap tank capacity: 1600 ml.

Miscelatore elettronico monoacqua con dispenser di sapone automatico per lavabo

Azionato mediante sensore a infrarossi. Capacità del dosatore di sapone: 1600 ml.

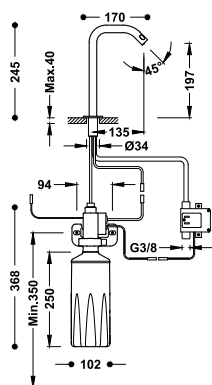

Wall-mounted electronic washbasin tap with 1 water outlet

39210318

313,00

Operated by infrared sensor. The battery box is located inside the spout itself. G1/2 male threaded connection.

Miscelatore elettronico a muro monoacqua per lavabo

Azionato mediante sensore a infrarossi. Il portabatterie è posizionato all'interno della canna. Attacco filettato maschio da G1/2.

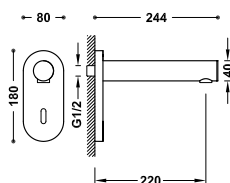

**WITHOUT DOING ANY WORK
NESSUN LAVORO DI COSTRUZIONE**

The battery box is located inside the spout itself. Patented system.

Il portabatterie è posizionato all'interno della canna. Sistema brevettato.



4 x
AAA / LR06
Batteries NOT included / Batterie NON incluse
Long life: 8 years / Lunga tenuta: 8 anni

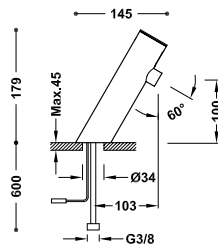

Electronic washbasin tap with pre-mixing system

Operated by infrared sensor. With temperature selector via a lateral handle. Water flow: 6 l/min.

39210301

205,00

Rubinetto elettronico con sistema di premiscelazione per lavabo

Azionato mediante sensore a infrarossi. Con selettore di temperatura tramite una leva laterale. Flusso: 6 l/min.

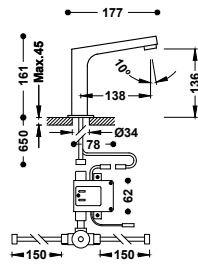

Electronic washbasin tap with pre-mixing system

Operated by infrared sensor. Includes a 2-outlet mixer valve with flexible hoses.

39210309

251,00

Rubinetto elettronico con sistema di premiscelazione per lavabo

Azionato mediante sensore a infrarossi. È inclusa una valvola miscelatrice a 2 getti con tubi flessibili.

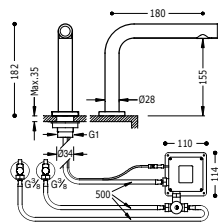

Electronic washbasin tap with pre-mixing system

Touch-tres touch system. Includes a 2-outlet mixer valve with flexible hoses (925730).

06144801

310,00

Rubinetto elettronico con sistema di premiscelazione per lavabo

Sistema sensibile al tatto Touch-tres. È inclusa una valvola miscelatrice a 2 getti con tubi flessibili.

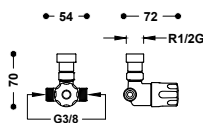

2-outlet mixer valve for timed or electronic taps

Suitable for transporting pre-mixed water to a kitchen or washbasin tap with one water outlet.

29944601

55,00

Valvola miscelatrice a 2 getti per miscelatore temporizzato o elettronico

Adatto per far passare l'acqua premiscelata a un miscelatore a 1 getto da lavabo e cucina.

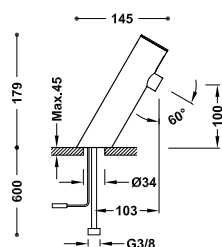

ELECTRONIC WASHBASIN TAP KITS / KITS MISCELATORE ELETTRONICO

**Electronic washbasin tap kit with 1 water outlet**

39210391

204,00

39210302 - Electronic washbasin tap with 1 water outlet.
 134215028 - Always-open drainage valve for washbasin.
 134215024 - Curved articulated drain trap for washbasin.
 134215007 x 1 - Angle valve with filter.

Kit miscelatore elettronico monoacqua per lavabo

39210302 - Miscelatore elettronico monoacqua per lavabo
 134215028 - Valvola di scarico sempre aperto per lavabo.
 134215024 - Sifone curvo articolato per lavabo.
 134215007 x 1 - Valvola squadrata con filtro.

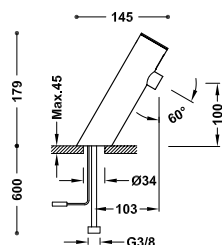
**Electronic washbasin tap kit with pre-mixing system**

39210390

254,00

39210301 - Electronic washbasin tap with pre-mixing system
 134215028 - Always-open drainage valve for washbasin.
 134215024 - Curved articulated drain trap for washbasin.
 134215007 x 2 - Angle valve with filter.

Kit miscelatore elettronico con sistema di premiscelazione per lavabo

39210301 - Miscelatore elettronico con sistema di premiscelazione per lavabo
 134215028 - Valvola di scarico sempre aperto per lavabo.
 134215024 - Sifone curvo articolato per lavabo.
 134215007 x 2 - Valvola squadrata con filtro.

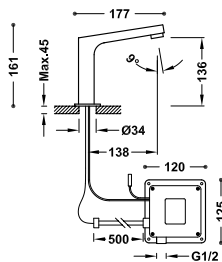
**Electronic washbasin tap kit with 1 water outlet**

39210397

250,00

39210317 - Electronic washbasin tap with 1 water outlet.
 134215028 - Always-open drainage valve for washbasin.
 134215024 - Curved articulated drain trap for washbasin.
 134215007 x 1 - Angle valve with filter.

Kit miscelatore elettronico monoacqua per lavabo

39210317 - Miscelatore elettronico monoacqua per lavabo
 134215028 - Valvola di scarico sempre aperto per lavabo.
 134215024 - Sifone curvo articolato per lavabo.
 134215007 x 1 - Valvola squadrata con filtro.

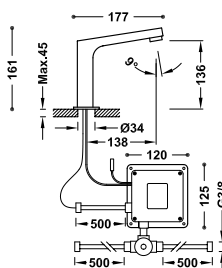
**Electronic washbasin tap kit with pre-mixing system**

39210399

300,00

39210309 - Electronic washbasin tap with pre-mixing system
 134215028 - Always-open drainage valve for washbasin.
 134215024 - Curved articulated drain trap for washbasin.
 134215007 x 2 - Angle valve with filter.

Kit miscelatore elettronico con sistema di premiscelazione per lavabo

39210309 - Miscelatore elettronico con sistema di premiscelazione per lavabo
 134215028 - Valvola di scarico sempre aperto per lavabo.
 134215024 - Sifone curvo articolato per lavabo.
 134215007 x 2 - Valvola squadrata con filtro.



SOAP DISPENSERS / DISPENSER DI SAPONE

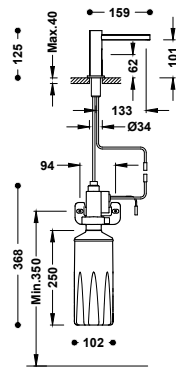

Electronic soap dispenser for bathroom and kitchen

39274101 310,00

Operated by infrared sensor. Soap tank capacity: 1600 ml.

39274101NM 480,00

Dispenser elettronico di sapone per lavabo e cucina

Azionato mediante sensore a infrarossi. Capacità del dosatore di sapone: 1600 ml.

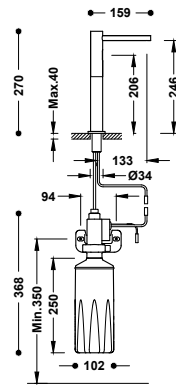

High electronic soap dispenser for bathroom and kitchen

39274102 315,00

Operated by infrared sensor. Soap tank capacity: 1600 ml.

Dispenser elettronico alto di sapone per lavabo e cucina

Azionato mediante sensore a infrarossi. Capacità del dosatore di sapone: 1600 ml.

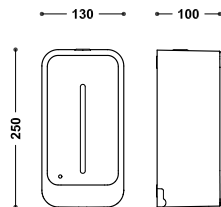

Electronic soap or gel dispenser

01240801 68,00

Operated by infrared sensor. Soap tank capacity: 1000 ml.

Dispenser elettronico di gel o sapone

Azionato mediante sensore a infrarossi. Capacità del dosatore di sapone: 1000 ml.

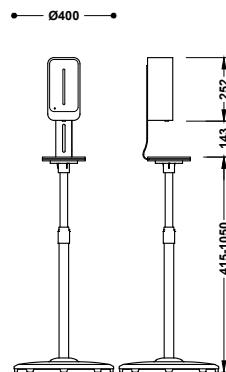

Floor stand with shelf and electronic gel or soap dispenser

01240850 152,00

Adjustable height for the home, business, school, hotel Soap tank capacity: 1000 ml.

Supporto da pavimento con mensola e dispenser elettronico di gel o sapone

Regolabile in altezza per casa, posto di lavoro, scuola, hotel. Capacità del dosatore di sapone: 1000 ml.



WC SENSORS / SENSORI WC

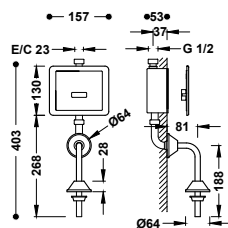

Concealed electronic urinal tap with sensor

01220704

185,00

Operated by infrared sensor. With one pipe adapted to urinal.
Material: Stainless steel.

Miscelatore elettronico a incasso con sensore per orinatoio

Azionato mediante sensore a infrarossi. Con un tubo adattabile a orinatoio. Materiale: Acciaio inossidabile.

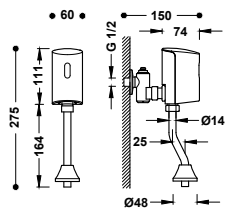

Wall-mounted electronic urinal flush tap with 1 water outlet

01220703

130,00

Operated by infrared sensor. With one pipe adapted to urinal.

Miscelatore di scarico elettronico a muro monoacqua per orinatoio

Azionato mediante sensore a infrarossi. Con un tubo adattabile a orinatoio.



HAND DRYER / ASCIUGA MANI

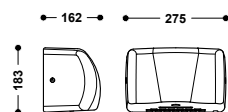

Automatic hot-air hand dryer

39274201

202,00

Operated by an infrared sensor

39274201AC

202,00

Asciugamani automatico ad aria calda

39274201BL

202,00

Azionamento tramite sensore a infrarossi



KITCHEN ELECTRONIC TAP / CUCINA ELETTRONICA

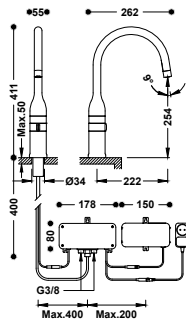

Electronic kitchen mixer tap

- Activated by infra-red sensor.
- Temperature adjustment using a handle on the body.
- With G3/8 flexible connection hoses.

Miscelatore elettronico per cucina

- Azionato da sensore a infrarossi.
- Con regolazione della temperatura tramite volantino situato sul corpo.
- Con flessibili di alimentazione G3/8.



23044501	630,00
23044501NM	976,00
23044501AC	976,00
230445010M	1.323,00
230445010PM	1.323,00

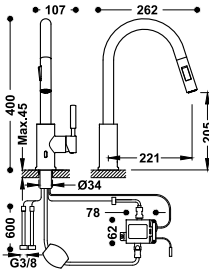

Electronic tap with pull-out spout and 2 types of jet for the kitchen

Operated by infrared sensor. With flow and temperature regulator via a lateral lever. Material: Stainless steel.

Rubinetto elettronico con doccetta estraibile e 2 tipi di getto per cucina

Azionato mediante sensore a infrarossi. Con selettore di regolatore di flusso e temperatura tramite una leva laterale. Materiale: Acciaio inossidabile.



09244501AC	345,00
------------	--------

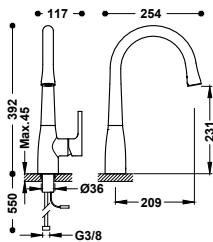

Electronic kitchen mixer tap

Operated by infrared sensor behind the water outlet. With flow and temperature regulator via a lateral lever.

Miscelatore elettronico per cucina

Azionato mediante sensore a raggi infrarossi situato nella parte retrostante il getto. Con selettore di regolatore di flusso e temperatura tramite una leva laterale.



09244601	310,00
----------	--------

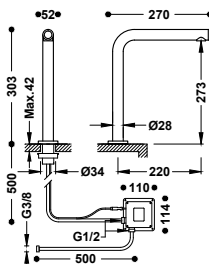

Electronic kitchen mixer tap with 1 water outlet

Touch-tres touch system. With G3/8 flexible hose.

Miscelatore elettronico monoacqua per cucina

Sistema sensibile al tatto Touch-tres. Con flessibili di alimentazione G3/8.



161445	325,00
--------	--------

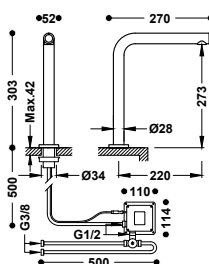

Electronic tap with pre-mixing system for kitchen

Touch-tres touch system. Includes a 2-outlet mixer valve with flexible hoses. With G3/8 flexible hose.

Miscelatore elettronico con sistema di premiscelazione per cucina

Sistema sensibile al tatto Touch-tres. È inclusa una valvola miscelatrice a 2 getti con tubi flessibili. Con flessibili di alimentazione G3/8.



161446	375,00
--------	--------





KITCHEN AREA

SPAZIO CUCINA

436 Single-lever mixer taps
Monocomandi

446 For filtered water
Per acqua filtrata

450 With folding spout
Con canna a scomparsa

450 With flexible spout
Con canna flessibile

452 With pull-out spout
Con canna estraibile

455 Electronic
Elettronici

456 Two-handle
Bicomandi































459 Wall-mounted
A muro































462 Industrial
Industriali

464 Taps for various uses
Rubinetti per usi diversi



SINGLE-LEVER MIXER TAPS / MONOCOMANDI





Reference Riferimento	Page Pagina	Available finishes Finiture disponibili	Technology Tecnologia	Height (mm) Altezza (mm)
 106486	→436			300
 130496	→436			305
 106440	→436			270
 23044002	→436			300
 20548601	→436			296
 162435	→437			310
 130336	→437			286
 23044006	→437			337
 162436	→437			304
 181436	→437			304
 23044007	→438			337

Reference Riferimento	Page Pagina	Available finishes Finiture disponibili	Technology Tecnologia	Height (mm) Altezza (mm)
 24234101	→438			293
 24244101	→438			268
 23044003	→438			410
 23044005	→438			424
 20044002	→439			418
 20544001 06254201	→439			418
 181540	→439			417
 162440	→439			426
 162442	→440			350
 21644020 21644010	→440			378
 181341 183341	→440			351
 169440 117440	→441			380

	Reference Riferimento	Page Pagina	Available finishes Finiture disponibili	Technology Tecnologia	Height (mm) Altezza (mm)
	06944001	→441			330
	139441 17044102 21544101	→441			260
	172440 17044002	→442			233
	07044802	→442			261
	06944701 172447 17044702	→442			352
	21644720 21644710	→443			338
	08333301	→443			300
	117333 17033302 172333 21533301	→444			180

FOR FILTERED WATER / PER ACQUA FILTRATA













	23045301	→446			424
	23045403	→446			313
	23045402	→446			375

	Reference Riferimento	Page Pagina	Available finishes Finiture disponibili	Technology Tecnologia	Height (mm) Altezza (mm)
	23050401	→446			263
	23050402	→446			271





WITH FOLDING SPOUT / CON CANNA A SCOMPARSA



	23033503	→450			256
	130335	→450			256
	23033502	→450			320
	24233401	→450			293

WITH FLEXIBLE SPOUT / CON CANNA FLESSIBILE























	00648701	→450			455
	23048702	→451			469
	23048701	→451			469
	20548702	→451			450

















	Reference Riferimento	Page Pagina	Available finishes Finiture disponibili	Technology Tecnologia	Height (mm) Altezza (mm)
	03048501	→451			548
	03049301	→451			564

	Reference Riferimento	Page Pagina	Available finishes Finiture disponibili	Technology Tecnologia	Height (mm) Altezza (mm)
	03043401	→454			394
	23043840	→454			

WITH PULL-OUT SPOUT / CON CANNA ESTRAIBILE

	106437	→452			300
 N	23043801	→452			417
 N	23043803	→452			369
	162438 181438	→452			315
	162437 181437	→453			293
 N	23043802	→453			455
 N	23043804	→453			461
	114444	→453			370
	06944401 03044401	→454			300

ELECTRONIC / ELETTRONICI

 N	23044501	→455			411
	09244501AC	→455		 	400
	09244601	→455		 	392
	161445 161446	→455		 	303

TWO-HANDLE / BICOMANDI

	163333	→456			427
	24234201	→456			256
	123342	→456			286
	24231001	→456			283*

	Reference Riferimento	Page Pagina	Available finishes Finiture disponibili	Technology Tecnologia	Height (mm) Altezza (mm)
	123310 123210	→456			270*
	24221501	→457			284*
	123214 123215 123230	→457			219*
	123314 123315 123330 123360	→458			219*
	123416	→458			309*
	123317	→459			301*
	123217	→459			301*

WALL-MOUNTED / A MURO

	172318 172317	→459			287* 293*
	07032003 17041802 17032002	→459			217* 247* 287*
	21632010 21632020 21632030	→460			182* 242* 281*
	172420 17033202	→461			305* 305*

	Reference Riferimento	Page Pagina	Available finishes Finiture disponibili	Technology Tecnologia	Height (mm) Altezza (mm)
	172218 172418	→461			283* 283*
	17031802 17021802	→461			283* 283*
	21642010	→462			277*

INDUSTRIAL / INDUSTRIALI

	130495	→462			760
	130484	→463			1355
	130481	→463			1200

1 WATER / 1 ACQUA

	123306	→464			265
	123505	→464			298*
	123506	→464			248*

* Length of the spout / Lunghezza della canna







SINGLE-LEVER MIXER TAPS / MONOCOMANDI

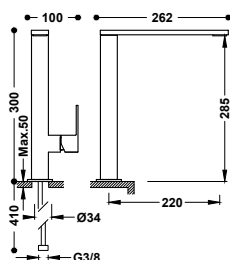

Single-handle kitchen mixer tap

With G3/8 flexible hose.

Miscelatore monocomando per cucina

Con flessibili di alimentazione G3/8.

106486	420,00
006486NM	651,00
006486BM	651,00
50648603	651,00
006486OM	924,00

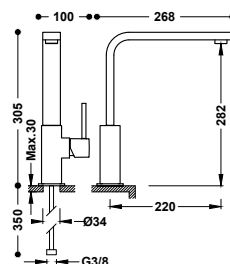

Single-handle kitchen mixer tap

With G3/8 flexible hose.

Miscelatore monocomando per cucina

Con flessibili di alimentazione G3/8.

130496	304,00
030496NM	471,00
030496BM	471,00
53049603	471,00
030496OM	669,00

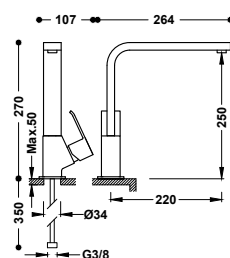

Single-handle kitchen mixer tap

With G3/8 flexible hose.

Miscelatore monocomando per cucina

Con flessibili di alimentazione G3/8.

106440	360,00
--------	--------

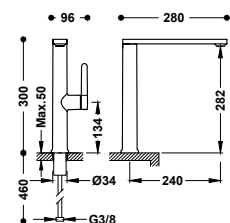

Single-handle kitchen mixer tap

With G3/8 flexible hose.

Miscelatore monocomando per cucina

Con flessibili di alimentazione G3/8.

23044002	245,00
23044002NM	380,00
23044002BM	380,00
23044002AC	380,00
23044002OM	539,00
23044002OPM	539,00

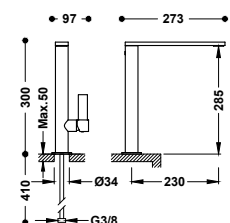

Single-handle kitchen mixer tap

With G3/8 flexible hose.

Miscelatore monocomando per cucina

Con flessibili di alimentazione G3/8.

20548601	250,00
20548601NM	388,00
20548601BM	388,00
20548601AC	388,00
20548601OM	550,00



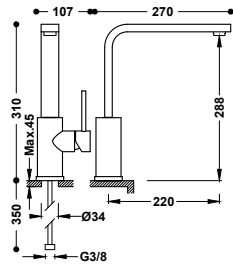

Single-handle kitchen mixer tap

With G3/8 flexible hose.

Miscelatore monocomando per cucina

Con flessibili di alimentazione G3/8.

■ 162435	265,00
■ 062435NM	411,00
■ 062435BM	411,00
■ 062435AC	411,00
■ 062435OM	583,00

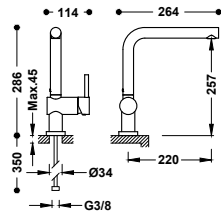

Single-handle kitchen mixer tap

With G3/8 flexible hose.

Miscelatore monocomando per cucina

Con flessibili di alimentazione G3/8.

■ 130336	240,00
■ 030336BM	372,00
■ 030336AC	372,00

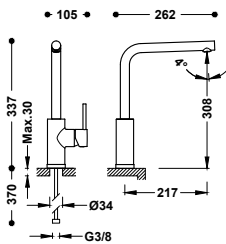

Single-handle kitchen mixer tap

With G3/8 flexible hose.

Miscelatore monocomando per cucina

Con flessibili di alimentazione G3/8.

■ 23044006	160,00
■ 23044006NM	248,00
■ 23044006AC	248,00

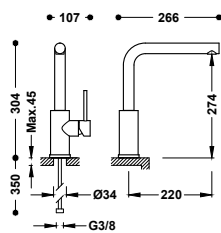

Single-handle kitchen mixer tap

With G3/8 flexible hose.

Miscelatore monocomando per cucina

Con flessibili di alimentazione G3/8.

■ 162436	230,00
■ 06243601NM	357,00
■ 06243601BM	357,00
■ 06243601AC	357,00
■ 06243601OM	506,00

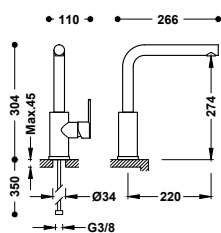

Single-handle kitchen mixer tap

With G3/8 flexible hose.

Miscelatore monocomando per cucina

Con flessibili di alimentazione G3/8.

■ 181436	210,00
----------	--------



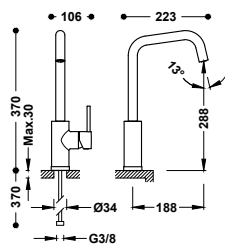

Single-handle kitchen mixer tap

With G3/8 flexible hose.

Miscelatore monocomando per cucina

Con flessibili di alimentazione G3/8.

- 23044007 140,00
- 23044007NM 217,00
- 23044007AC 217,00

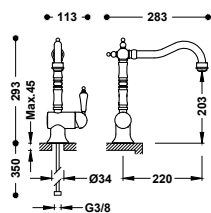

Single-handle kitchen mixer tap

With G3/8 flexible hose.

Miscelatore monocomando per cucina

Con flessibili di alimentazione G3/8.

- 24234101 321,00
- 24234101AC 498,00
- 24234101OR 706,00
- 24234101LV 465,00
- 24234101LM 465,00

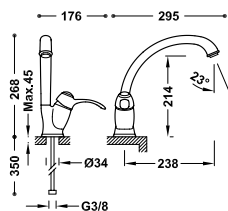

Single-handle kitchen mixer tap

With G3/8 flexible hose.

Miscelatore monocomando per cucina

Con flessibili di alimentazione G3/8.

- 24244101 210,00
- 24244101AC 326,00
- 24244101OR 462,00
- 24244101LV 305,00
- 24244101LM 305,00

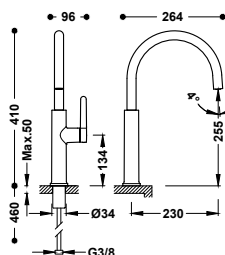

Single-handle kitchen mixer tap

With G3/8 flexible hose.

Miscelatore monocomando per cucina

Con flessibili di alimentazione G3/8.

- 23044003 220,00
- 23044003NM 341,00
- 23044003BM 341,00
- 23044003AC 341,00
- 23044003OM 484,00
- 23044003OPM 484,00

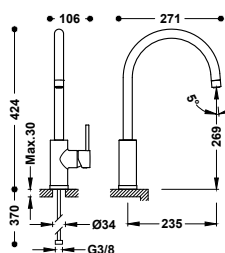

Single-handle kitchen mixer tap

With G3/8 flexible hose.

Miscelatore monocomando per cucina

Con flessibili di alimentazione G3/8.

- 23044005 125,00
- 23044005NM 194,00
- 23044005AC 194,00



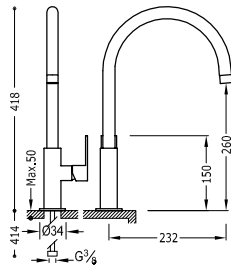

Single-handle kitchen mixer tap

With G3/8 flexible hose.

Miscelatore monocomando per cucina

Con flessibili di alimentazione G3/8.



	20044002	232,00
	20044002NM	360,00
	20044002BM	360,00
	20044002AC	360,00

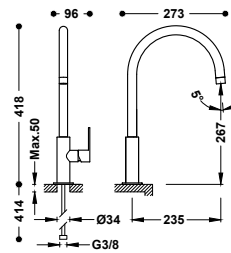

Single-handle kitchen mixer tap

With G3/8 flexible hose.

Miscelatore monocomando per cucina

Con flessibili di alimentazione G3/8.



	20544001	228,00
	20544001NM	353,00
	20544001BM	353,00
	20544001AC	353,00
	20544001OM	502,00

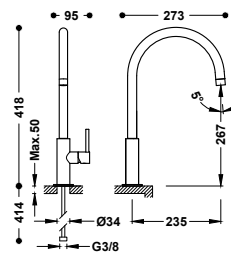

Single-handle kitchen mixer tap

With G3/8 flexible hose.

Miscelatore monocomando per cucina

Con flessibili di alimentazione G3/8.



	06254201	224,00
	06254201NM	347,00
	06254201BM	347,00
	06254201AC	347,00
	06254201OM	493,00

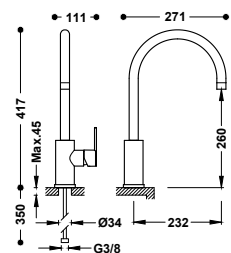

Single-handle kitchen mixer tap

With G3/8 flexible hose.

Miscelatore monocomando per cucina

Con flessibili di alimentazione G3/8.



	181540	228,00
--	--------	--------

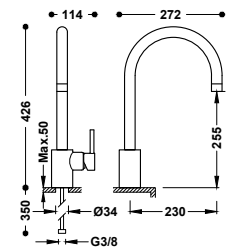

Single-handle kitchen mixer tap

With G3/8 flexible hose.

Miscelatore monocomando per cucina

Con flessibili di alimentazione G3/8.



	162440	200,00
	56244003	310,00



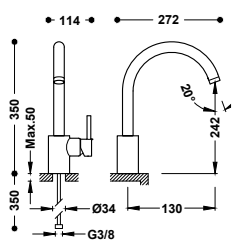

Single-handle kitchen mixer tap

162442

180,00

With G3/8 flexible hose.

Miscelatore monocomando per cucina

Con flessibili di alimentazione G3/8.

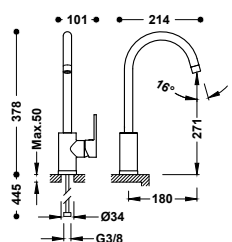

Single-handle kitchen mixer tap

21644020

89,00

With G3/8 flexible hoses.

Miscelatore monocomando per cucina

Con flessibili di alimentazione G3/8.

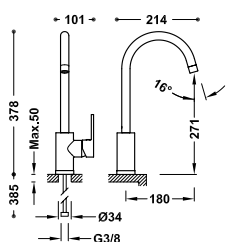

Single-handle kitchen mixer tap

21644010

83,00

With G3/8 flexible hoses.

Miscelatore monocomando per cucina

Con flessibili di alimentazione G3/8.

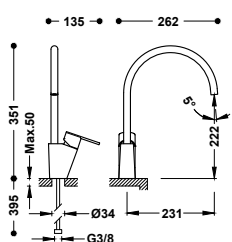

Single-handle kitchen mixer tap

181341

135,00

With G3/8 flexible hose.

Miscelatore monocomando per cucina

Con flessibili di alimentazione G3/8.

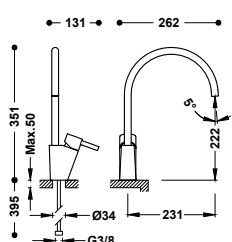

Single-handle kitchen mixer tap

183341

125,00

With G3/8 flexible hose.

Miscelatore monocomando per cucina

Con flessibili di alimentazione G3/8.



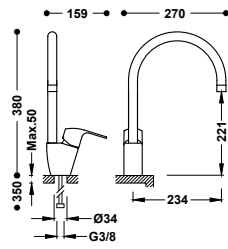

Single-handle kitchen mixer tap

169440

112,00

With G3/8 flexible hoses.

Miscelatore monocomando per cucina

Con flessibili di alimentazione G3/8.



913429510

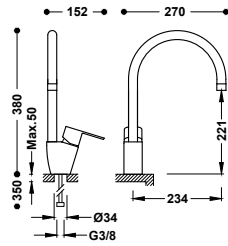

Single-handle kitchen mixer tap

117440

112,00

With G3/8 flexible hoses.

Miscelatore monocomando per cucina

Con flessibili di alimentazione G3/8.



913429510

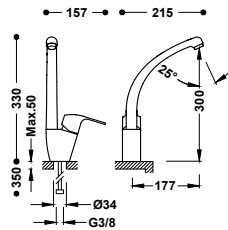

Single-handle kitchen mixer tap

06944001

106,00

With G3/8 flexible hoses.

Miscelatore monocomando per cucina

Con flessibili di alimentazione G3/8.



913427010

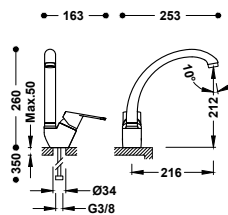

Single-handle kitchen mixer tap

139441

85,00

With G3/8 flexible hoses.

Miscelatore monocomando per cucina

Con flessibili di alimentazione G3/8.



913438510

IA

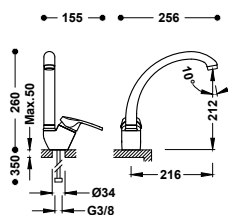

Single-handle kitchen mixer tap

17044102

76,00

With G3/8 flexible hoses.

Miscelatore monocomando per cucina

Con flessibili di alimentazione G3/8.



360°

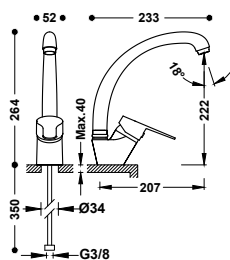

Single-handle kitchen mixer tap

21544101

71,00

With G3/8 flexible hoses.

Miscelatore monocomando per cucina

Con flessibili di alimentazione G3/8.

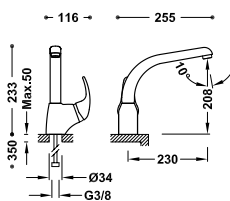

Single-handle kitchen mixer tap

172440

112,00

With G3/8 flexible hoses.

Miscelatore monocomando per cucina

Con flessibili di alimentazione G3/8.

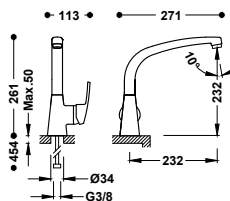

Single-handle kitchen mixer tap

07044802

108,00

With G3/8 flexible hoses.

Miscelatore monocomando per cucina

Con flessibili di alimentazione G3/8.

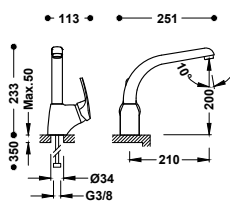

Single-handle kitchen mixer tap

17044002

108,00

With G3/8 flexible hoses.

Miscelatore monocomando per cucina

Con flessibili di alimentazione G3/8.

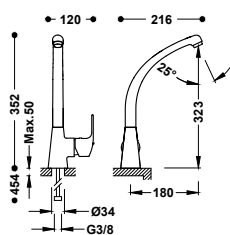

Single-handle kitchen mixer tap

06944701

102,00

With G3/8 flexible hoses.

Miscelatore monocomando per cucina

Con flessibili di alimentazione G3/8.



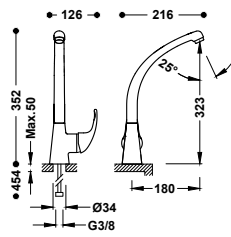

Single-handle kitchen mixer tap

172447

102,00

With G3/8 flexible hoses.

Miscelatore monocomando per cucina

Con flessibili di alimentazione G3/8.

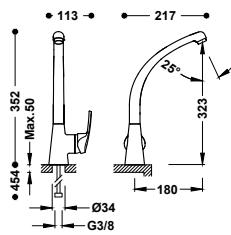

Single-handle kitchen mixer tap

17044702

102,00

With G3/8 flexible hoses.

Miscelatore monocomando per cucina

Con flessibili di alimentazione G3/8.

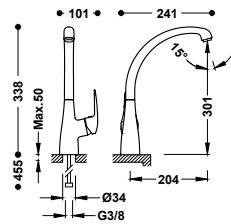

Single-handle kitchen mixer tap

21644720

84,00

With G3/8 flexible hoses.

Miscelatore monocomando per cucina

Con flessibili di alimentazione G3/8.

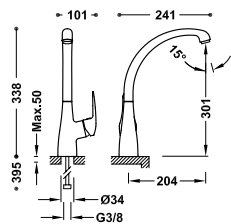

Single-handle kitchen mixer tap

21644710

78,00

With G3/8 flexible hoses.

Miscelatore monocomando per cucina

Con flessibili di alimentazione G3/8.

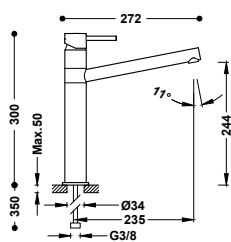

Single-handle kitchen mixer tap

08333301

168,00

With G3/8 flexible hoses.

Miscelatore monocomando per cucina

Con flessibili di alimentazione G3/8.



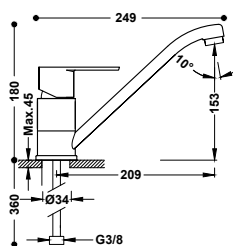

Single-handle kitchen mixer tap

With G3/8 flexible hoses.

Miscelatore monocomando per cucina

Con flessibili di alimentazione G3/8.

117333

93,00

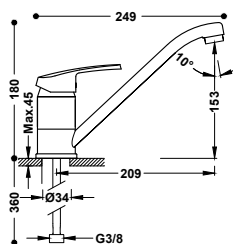

Single-handle kitchen mixer tap

With G3/8 flexible hoses.

Miscelatore monocomando per cucina

Con flessibili di alimentazione G3/8.

17033302

85,00

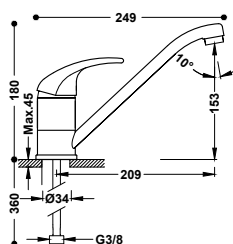

Single-handle kitchen mixer tap

With G3/8 flexible hoses.

Miscelatore monocomando per cucina

Con flessibili di alimentazione G3/8.

172333

82,00

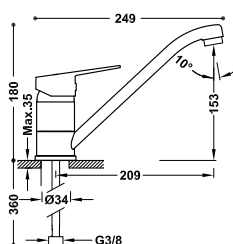

Single-handle kitchen mixer tap

With G3/8 flexible hoses.

Miscelatore monocomando per cucina

Con flessibili di alimentazione G3/8.

21533301

65,00





FOR FILTERED WATER / PER ACQUA FILTRATA

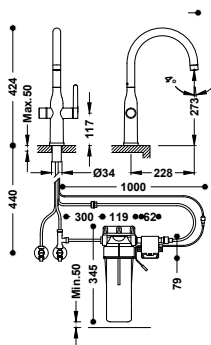

Dual-source single lever kitchen mixer tap for mains and filtered water

- With touch system for filtered water.
- Includes a filter for six months (10,000 litres) of filtered water.
- The filter removes bacteria, viruses and heavy metals.
- Flexible G3/8 connection hoses.

Rubinetto monocomando a 2 vie per cucina, per acqua di rete di erogazione e filtrata

- Con sistema tattile per acqua filtrata.
- Include filtro per 6 mesi (10.000 litri) di acqua filtrata.
- Il filtro elimina batteri, virus e metalli pesanti.
- Flessibili di alimentazione G3/8.



■ 23045301	470,00
■ 23045301NM	705,00
■ 23045301AC	705,00
■ 23045301OM	987,00
■ 23045301OPM	987,00

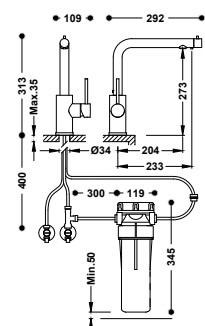

Dual-source single lever kitchen mixer tap for mains and filtered water

- Separate flow regulation and closure.
- Includes a filter for six months (10,000 litres) of filtered water.
- The filter removes bacteria, viruses and heavy metals.
- Flexible G3/8 connection hoses.

Rubinetto monocomando a 2 vie per cucina, per acqua di rete di erogazione e filtrata

- Chiusura e regolazione della portata indipendenti.
- Include filtro per 6 mesi (10.000 litri) di acqua filtrata.
- Il filtro elimina batteri, virus e metalli pesanti.
- Flessibili di alimentazione G3/8.



■ 23045403	311,00
■ 23045403NM	434,00

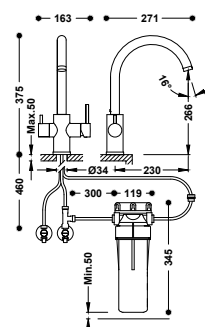

Dual-source single lever kitchen mixer tap for mains and filtered water

- Separate flow regulation and closure.
- Includes a filter for six months (10,000 litres) of filtered water.
- The filter removes bacteria, viruses and heavy metals.
- Flexible G3/8 connection hoses.

Rubinetto monocomando a 2 vie per cucina, per acqua di rete di erogazione e filtrata

- Chiusura e regolazione della portata indipendenti.
- Include filtro per 6 mesi (10.000 litri) di acqua filtrata.
- Il filtro elimina batteri, virus e metalli pesanti.
- Flessibili di alimentazione G3/8.



■ 23045402	311,00
■ 23045402NM	434,00

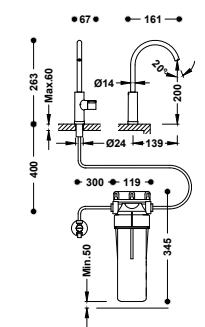

Single-source kitchen tap, for filtered water

- Includes a filter for six months (10,000 litres) of filtered water.
- The filter removes bacteria, viruses and heavy metals.
- Flexible G3/8 connection hoses.

Rubinetto a 1 via per acqua da cucina e acqua filtrata

- Include filtro per 6 mesi (10.000 litri) di acqua filtrata.
- Il filtro elimina batteri, virus e metalli pesanti.
- Flessibili di alimentazione G3/8.



■ 23050401	243,00
■ 23050401NM	344,00
■ 23050401OM	481,00
■ 23050401OPM	481,00

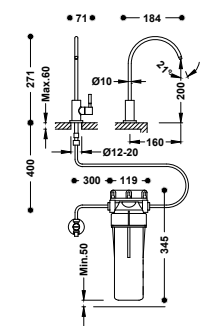

Single-source kitchen tap, for filtered water

- Includes a filter for six months (10,000 litres) of filtered water.
- The filter removes bacteria, viruses and heavy metals.
- Flexible G3/8 connection hoses.

Rubinetto a 1 via per acqua da cucina e acqua filtrata

- Include filtro per 6 mesi (10.000 litri) di acqua filtrata.
- Il filtro elimina batteri, virus e metalli pesanti.
- Flessibili di alimentazione G3/8.



■ 23050402	162,00
------------	--------

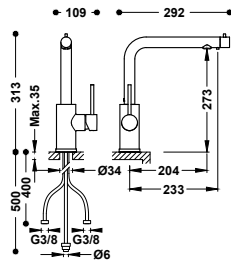

Dual-source single lever kitchen mixer tap for mains and filtered water

- Separate flow regulation and closure.
- Flexible G3/8 connection hoses.

Rubinetto monocomando a 2 vie per cucina, per acqua di rete di erogazione e filtrata

- Chiusura e regolazione della portata indipendenti.
- Flessibili di alimentazione G3/8.



■ 23045303	250,00
■ 23045303NM	388,00

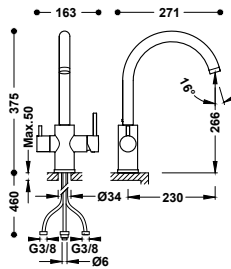

Dual-source single lever kitchen mixer tap for mains and filtered water

- Separate flow regulation and closure.
- Flexible G3/8 connection hoses.

Rubinetto monocomando a 2 vie per cucina, per acqua di rete di erogazione e filtrata

- Chiusura e regolazione della portata indipendenti.
- Flessibili di alimentazione G3/8.



■ 23045302	250,00
■ 23045302NM	388,00

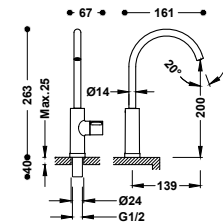

Single-source kitchen tap, for filtered water

With G3/8 flexible shower hose.

Rubinetto a 1 via per acqua da cucina e acqua filtrata

Con flessibili di alimentazione G3/8.



■ 23050301	150,00
■ 23050301NM	233,00
■ 230503010M	330,00
■ 230503010PM	330,00

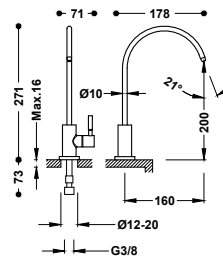

Single-source kitchen tap, for filtered water

With G3/8 flexible shower hose.

Rubinetto a 1 via per acqua da cucina e acqua filtrata

Con flessibili di alimentazione G3/8.



■ 23050302	60,00
------------	-------





The filter uses 100% of the mains water.
Il filtro sfrutta al 100% l'acqua della rete.

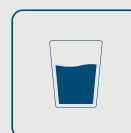

It eliminates impurities while respecting the mineral properties of the water.
Elimina le impurità rispettando le proprietà minerali dell'acqua.



It removes the need for bottled water, thereby reducing your impact on the environment.
Evita di dover utilizzare bottiglie per l'acqua, riducendo l'impatto ambientale.



Purified water at home for less.
Acqua purificata in casa a costi inferiori.



The Tres Seven+ purifying filter provides unbeatable protection against the contaminants and viruses present in water, as well giving you water that tastes good.

Il filtro purificante Seven+ di Tres offre una protezione insuperabile contro gli elementi contaminanti e i virus presenti nell'acqua, oltre a donare un buon sapore all'acqua.





Seven+

- Eliminates: Chemical substances, pharmaceutical products, heavy metals, pesticides, bacteria, particulates and viruses.
 - 10.000 liters of efficiency with standard usage conditions.
 - Minimal installation work in almost no space at all.
 - The filter can be replaced easily.
- *Elimina: Sostanze chimiche, Prodotti farmaceutici, Metalli pesanti, Pesticidi, Batteri, Particelle e virus.*
 - *10.000 litri di efficacia con l'uso regolare.*
 - *Installazione minima, in uno spazio minimo.*
 - *Il filtro si sostituisce facilmente.*

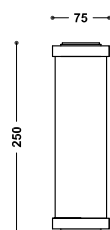

Seven+ water purifier filter

29945302

62,00

- The filter removes bacteria, viruses and heavy metals.

Filtro depuratore idrico Seven+

- *Il filtro elimina batteri, virus e metalli pesanti.*

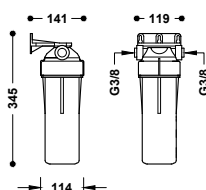

Container with Seven+ water purifier filter

29945303

120,00

- Includes a filter for six months (10,000 litres) of filtered water.
- The filter removes bacteria, viruses and heavy metals.

Contenitore con filtro depuratore idrico Seven+

- *Include filtro per 6 mesi (10.000 litri) di acqua filtrata.*
- *Il filtro elimina batteri, virus e metalli pesanti.*



Connections for adapting the Seven+ container and filter to any dual-source kitchen tap

29945304

53,00

Attacchi di adattamento del contenitore e del filtro Seven+ a qualsiasi rubinetto della cucina a due vie



WITH FOLDING SPOUT / CON CANNA A SCOMPARSA

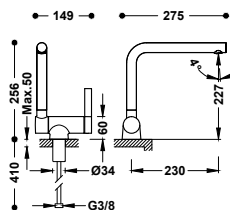

Single-handle kitchen mixer tap with folding spout

- With G3/8 flexible connection hoses.
- Total height with spout down: 6 cm.

Miscelatore monocomando con canna reclinabile per cucina

- Con flessibili di alimentazione G3/8.
- Altezza totale con beccuccio abbassato di 6 cm.

23033503	240,00
23033503NM	372,00
23033503BM	372,00
23033503AC	372,00
23033503OM	528,00
23033503OPM	528,00



29903516

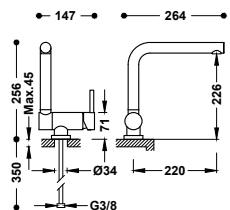

Single-handle kitchen mixer tap with folding spout

- With G3/8 flexible connection hoses.
- Total height with spout down: 7,1 cm.

Miscelatore monocomando con canna reclinabile per cucina

- Con flessibili di alimentazione G3/8.
- Altezza totale con beccuccio abbassato di 7,1 cm.

130335	255,00
030335NM	395,00
030335BM	395,00
030335AC	395,00
030335OM	561,00



913438510

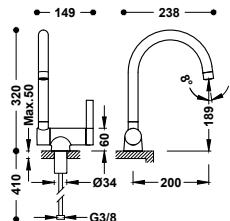

Single-handle kitchen mixer tap with folding spout

- With G3/8 flexible connection hoses.
- Total height with spout down: 6 cm.

Miscelatore monocomando con canna reclinabile per cucina

- Con flessibili di alimentazione G3/8.
- Altezza totale con beccuccio abbassato di 6 cm.

23033502	220,00
23033502NM	341,00
23033502BM	341,00
23033502AC	341,00
23033502OM	484,00
23033502OPM	484,00



29903516

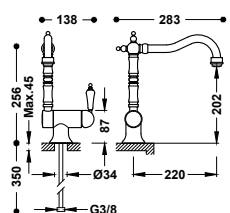

Single-handle kitchen mixer tap with folding spout

- With G3/8 flexible connection hoses.
- Total height with spout down: 8,7 cm.

Miscelatore monocomando con canna reclinabile per cucina

- Con flessibili di alimentazione G3/8.
- Altezza totale con beccuccio abbassato di 8,7 cm.

24233401	400,00
24233401AC	620,00
24233401OR	880,00
24233401LV	580,00
24233401LM	580,00



9134591

WITH FLEXIBLE SPOUT / CON CANNA FLESSIBILE

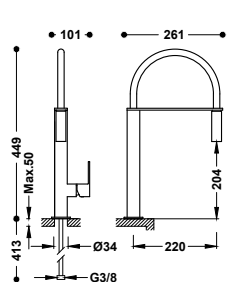

Single-handle kitchen mixer tap with flexible spout

- With G3/8 flexible hose.

Miscelatore monocomando con canna girevole per cucina

- Con flessibili di alimentazione G3/8.

00648701	485,00
00648701NM	752,00
00648701BM	752,00
00648701AC	752,00



9130190

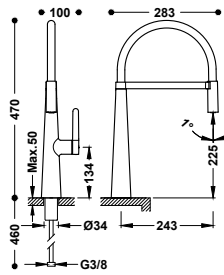

Single-handle kitchen mixer tap with flexible spout

- Magnetic attachment of spout to the support.
- With G3/8 flexible connection hoses.

Miscelatore monocomando con canna girevole per cucina

- Fissaggio del beccuccio di scarico al supporto tramite magnete.
- Con flessibili di alimentazione G3/8.



	23048702	360,00
	23048702NM	558,00
	23048702OM	792,00
	23048702OPM	792,00

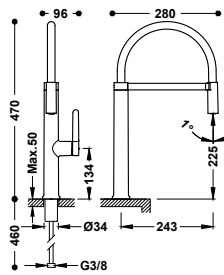

Single-handle kitchen mixer tap with flexible spout

- Magnetic attachment of spout to the support.
- With G3/8 flexible connection hoses.

Miscelatore monocomando con canna girevole per cucina

- Fissaggio del beccuccio di scarico al supporto tramite magnete.
- Con flessibili di alimentazione G3/8.



	23048701	330,00
	23048701OM	726,00
	23048701OPM	726,00

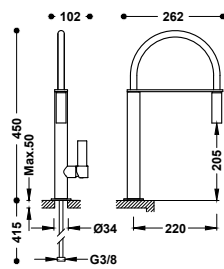

Single-handle kitchen mixer tap with flexible spout

- With G3/8 flexible hose.

Miscelatore monocomando con canna girevole per cucina

- Con flessibili di alimentazione G3/8.



	20548702	435,00
	20548702NM	674,00
	20548702BM	674,00
	20548702AC	674,00

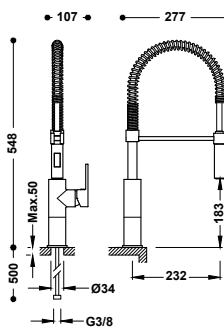

Single lever kitchen mixer with dual function pull-out spout

- With G3/8 flexible hose.

Miscelatore monocomando con doccetta estraibile e 2 tipi di getto per cucina

- Con flessibili di alimentazione G3/8.



	03048501	300,00
--	----------	--------

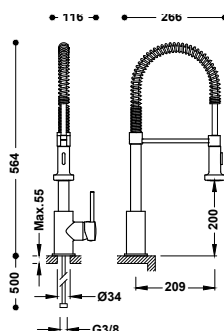

Single lever kitchen mixer with dual function pull-out spout

- With G3/8 flexible hose.

Miscelatore monocomando con doccetta estraibile e 2 tipi di getto per cucina

- Con flessibili di alimentazione G3/8.



	03049301	294,00
--	----------	--------



WITH PULL-OUT SPOUT / CON CANNA ESTRAIBILE

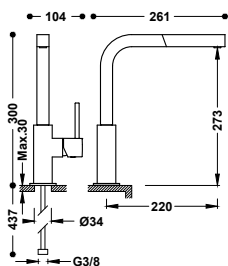

Single-handle kitchen mixer tap with pull-out spout

With G3/8 flexible hose.

Miscelatore monocomando con doccetta estraibile per cucina

Con flessibili di alimentazione G3/8.



106437	417,00
006437NM	646,00
006437BM	646,00
50643703	646,00
0064370M	917,00

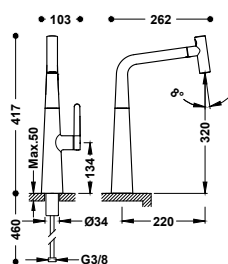

Single lever kitchen mixer with dual function pull-out spout

With retractable braided polyamide hose. With G3/8 flexible hose.

Miscelatore monocomando con doccetta estraibile e 2 tipi di getto per cucina

Con flessibile retrattile in poliammide intrecciata. Con flessibili di alimentazione G3/8.



23043801	340,00
----------	--------

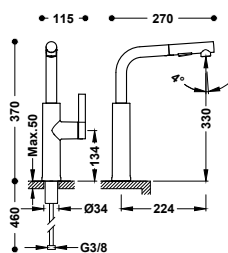

Single lever kitchen mixer with dual function pull-out spout

With retractable braided polyamide hose. With G3/8 flexible hose.

Miscelatore monocomando con doccetta estraibile e 2 tipi di getto per cucina

Con flessibile retrattile in poliammide intrecciata. Con flessibili di alimentazione G3/8.



23043803	260,00
23043803NM	403,00
23043803AC	403,00

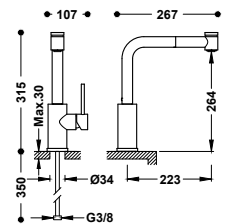

Single lever kitchen mixer with dual function pull-out spout

With G3/8 flexible hose.

Miscelatore monocomando con doccetta estraibile e 2 tipi di getto per cucina

Con flessibili di alimentazione G3/8.



162438	270,00
--------	--------

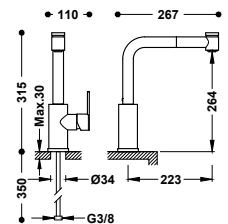

Single lever kitchen mixer with dual function pull-out spout

With G3/8 flexible hose.

Miscelatore monocomando con doccetta estraibile e 2 tipi di getto per cucina

Con flessibili di alimentazione G3/8.



181438	260,00
--------	--------

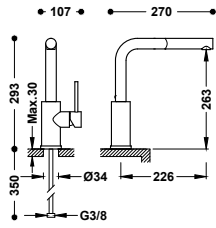

Single-handle kitchen mixer tap with pull-out spout

With G3/8 flexible hose.

Miscelatore monocomando con doccetta estraibile per cucina

Con flessibili di alimentazione G3/8.



162437	268,00
56243703	415,00

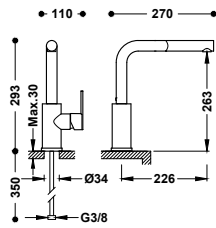

Single-handle kitchen mixer tap with pull-out spout

With G3/8 flexible hose.

Miscelatore monocomando con doccetta estraibile per cucina

Con flessibili di alimentazione G3/8.



181437	255,00
--------	--------

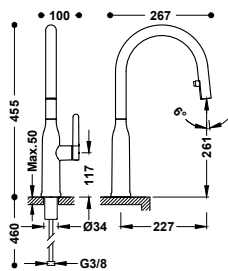

Single lever kitchen mixer with dual function pull-out spout

With retractable braided polyamide hose. With G3/8 flexible hose.

Miscelatore monocomando con doccetta estraibile e 2 tipi di getto per cucina

Con flessibile retrattile in poliammide intrecciata. Con flessibili di alimentazione G3/8.



23043802	300,00
23043802NM	465,00
23043802AC	465,00

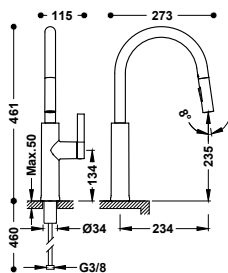

Single lever kitchen mixer with dual function pull-out spout

With retractable braided polyamide hose. With G3/8 flexible hose.

Miscelatore monocomando con doccetta estraibile e 2 tipi di getto per cucina

Con flessibile retrattile in poliammide intrecciata. Con flessibili di alimentazione G3/8.



23043804	190,00
23043804NM	295,00

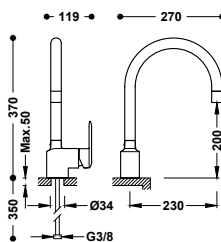

Single-handle kitchen mixer tap with pull-out spout

With G3/8 flexible hose.

Miscelatore monocomando con doccetta estraibile per cucina

Con flessibili di alimentazione G3/8.



114444	315,00
--------	--------



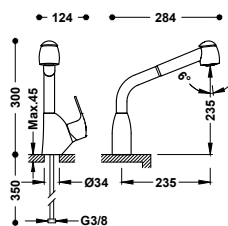

Single lever kitchen mixer with dual function pull-out spout

06944401

204,00

With G3/8 flexible hose.

Miscelatore monocomando con doccetta estraibile e 2 tipi di getto per cucina

Con flessibili di alimentazione G3/8.

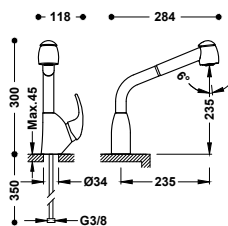

Single lever kitchen mixer with dual function pull-out spout

03044401

204,00

With G3/8 flexible hose.

Miscelatore monocomando con doccetta estraibile e 2 tipi di getto per cucina

Con flessibili di alimentazione G3/8.

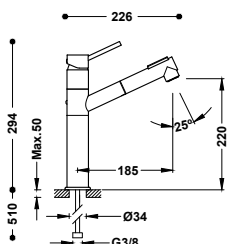

Single lever kitchen mixer with dual function pull-out spout

03043401

183,00

With G3/8 flexible hose.

Miscelatore monocomando con doccetta estraibile e 2 tipi di getto per cucina

Con flessibili di alimentazione G3/8.

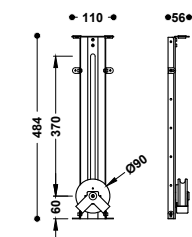

Kit for guiding the hose of the pull-out kitchen faucet

23043840

107,00

Kit per guidare il flessibile del rubinetto da cucina estraibile



ELECTRONIC / ELETTRONICI

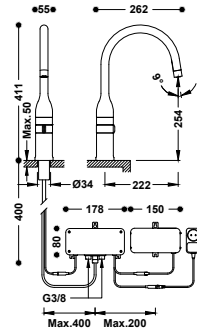

Electronic kitchen mixer tap

- Activated by infra-red sensor.
- Temperature adjustment using a handle on the body.
- With G3/8 flexible connection hoses.

Miscelatore elettronico per cucina

- Azionato da sensore a infrarossi.
- Con regolazione della temperatura tramite volantino situato sul corpo.
- Con flessibili di alimentazione G3/8.



23044501	630,00
23044501NM	976,00
23044501AC	976,00
230445010M	1.323,00
230445010PM	1.323,00

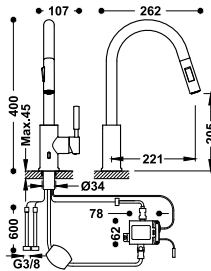

Electronic tap with pull-out spout and 2 types of jet for the kitchen

Operated by infrared sensor. With flow and temperature regulator via a lateral lever. Material: Stainless steel.

Rubinetto elettronico con doccetta estraibile e 2 tipi di getto per cucina

Azionato mediante sensore a infrarossi. Con selettore di regolatore di flusso e temperatura tramite una leva laterale. Materiale: Acciaio inossidabile.



09244501AC	345,00
------------	--------

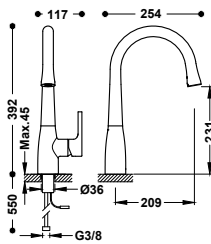

Electronic kitchen mixer tap

Operated by infrared sensor behind the water outlet. With flow and temperature regulator via a lateral lever.

Miscelatore elettronico per cucina

Azionato mediante sensore a raggi infrarossi situato nella parte retrostante il getto. Con selettore di regolatore di flusso e temperatura tramite una leva laterale.



09244601	310,00
----------	--------

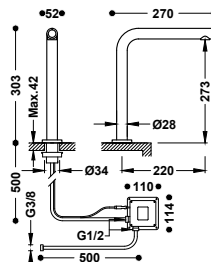

Electronic kitchen mixer tap with 1 water outlet

Touch-tres touch system. With G3/8 flexible hose.

Miscelatore elettronico monoacqua per cucina

Sistema sensibile al tatto Touch-tres. Con flessibili di alimentazione G3/8.



161445	325,00
--------	--------

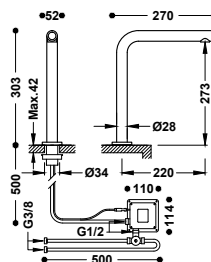

Electronic tap with pre-mixing system for kitchen

Touch-tres touch system. Includes a 2-outlet mixer valve with flexible hoses. With G3/8 flexible hose.

Miscelatore elettronico con sistema di premiscelazione per cucina

Sistema sensibile al tatto Touch-tres. È inclusa una valvola miscelatrice a 2 getti con tubi flessibili. Con flessibili di alimentazione G3/8.



161446	375,00
--------	--------



TWO-HANDLE / BICOMANDI

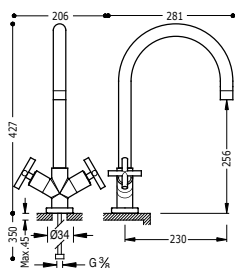

Two-handle kitchen mixer tap

With G3/8 flexible hose.

Miscelatore bicomando per cucina

Con flessibili di alimentazione G3/8.



163333

295,00

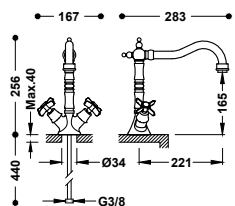

Two-handle kitchen mixer tap

With G3/8 flexible hose.

Miscelatore bicomando per cucina

Con flessibili di alimentazione G3/8.



9134282

24234201

237,00

24234201AC

367,00

24234201OR

521,00

24234201LV

344,00

24234201LM

344,00

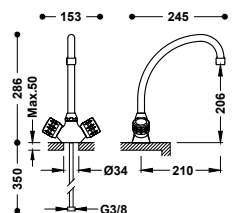

Two-handle kitchen mixer tap

With G3/8 flexible hoses.

Miscelatore bicomando per cucina

Con flessibili di alimentazione G3/8.



123342

85,00

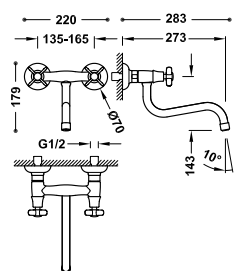

Wall-mounted two-handle kitchen mixer tap

With lower spout. Distance from wall: 273 mm.

Miscelatore bicomando a muro per cucina

Con canna inferiore. Distanza dal muro: 273 mm.



9134282

24231001

230,00

24231001AC

357,00

24231001OR

506,00

24231001LV

334,00

24231001LM

334,00

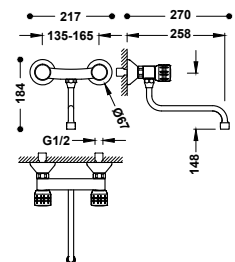

Wall-mounted two-handle kitchen mixer tap

With lower spout. Distance from wall: 258 mm.

Miscelatore bicomando a muro per cucina

Con canna inferiore. Distanza dal muro: 258 mm.



13 - 16

123310

78,00

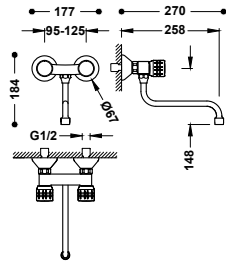

Wall-mounted two-handle kitchen mixer tap

With lower spout. Special offset. Distance from wall: 258 mm.

Miscelatore bicomando a muro per cucina

Con canna inferiore. Eccentricità speciale. Distanza dal muro: 258 mm.



123210

75,00

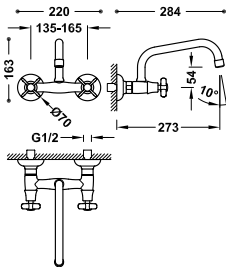

Wall-mounted two-handle kitchen mixer tap

With upper spout. Distance from wall: 273 mm.

Miscelatore bicomando a muro per cucina

Con canna superiore. Distanza dal muro: 273 mm.



24221501

235,00

24221501AC

364,00

24221501OR

517,00

24221501LV

341,00

24221501LM

341,00

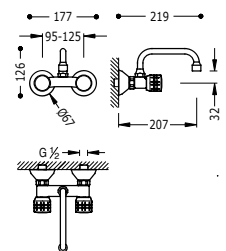

Wall-mounted two-handle kitchen mixer tap

With upper spout. Special offset. Distance from wall: 207 mm.

Miscelatore bicomando a muro per cucina

Con canna superiore. Eccentricità speciale. Distanza dal muro: 207 mm.



123214

76,00

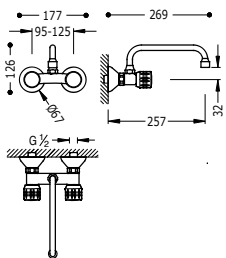

Wall-mounted two-handle kitchen mixer tap

With upper spout. Special offset. Distance from wall: 257 mm.

Miscelatore bicomando a muro per cucina

Con canna superiore. Eccentricità speciale. Distanza dal muro: 257 mm.



123215

78,00

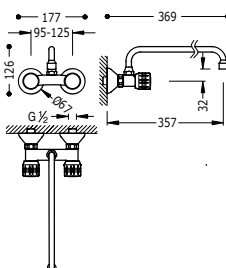

Wall-mounted two-handle kitchen mixer tap

With upper spout. Special offset. Distance from wall: 357 mm.

Miscelatore bicomando a muro per cucina

Con canna superiore. Eccentricità speciale. Distanza dal muro: 357 mm.



123230

80,00

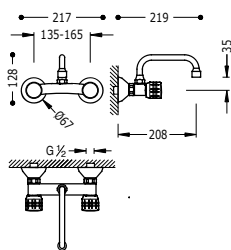

Wall-mounted two-handle kitchen mixer tap

123314

78,00

With upper spout. Distance from wall: 208 mm.

Miscelatore bicomando a muro per cucina

Con canna superiore. Distanza dal muro: 208 mm.

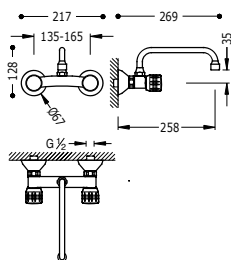

Wall-mounted two-handle kitchen mixer tap

123315

80,00

With upper spout. Distance from wall: 258 mm.

Miscelatore bicomando a muro per cucina

Con canna superiore. Distanza dal muro: 258 mm.

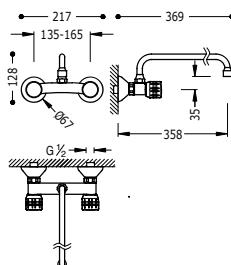

Wall-mounted two-handle kitchen mixer tap

123330

82,00

With upper spout. Distance from wall: 358 mm.

Miscelatore bicomando a muro per cucina

Con canna superiore. Distanza dal muro: 358 mm.

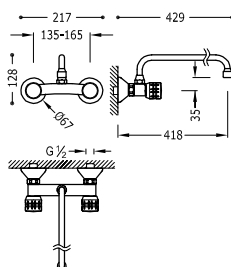

Wall-mounted two-handle kitchen mixer tap

123360

86,00

With upper spout. Distance from wall: 418 mm.

Miscelatore bicomando a muro per cucina

Con canna superiore. Distanza dal muro: 418 mm.

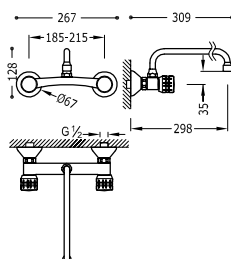

Wall-mounted two-handle kitchen mixer tap

123416

96,00

With upper spout. Special offset. Distance from wall: 298 mm.

Miscelatore bicomando a muro per cucina

Con canna superiore. Eccentricità speciale. Distanza dal muro: 298 mm.



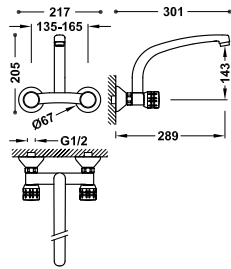

Wall-mounted two-handle kitchen mixer tap

123317

99,00

With upper spout. Distance from wall: 276 mm.

Miscelatore bicomando a muro per cucina

Con canna superiore. Distanza dal muro: 276 mm.

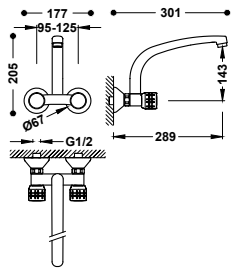

Wall-mounted two-handle kitchen mixer tap

123217

97,00

With upper spout. Special offset. Distance from wall: 276 mm.

Miscelatore bicomando a muro per cucina

Con canna superiore. Eccentricità speciale. Distanza dal muro: 276 mm.



WALL-MOUNTED / A MURO

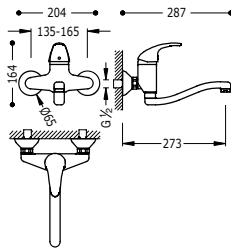

Wall-mounted single-handle kitchen mixer tap

172318

118,00

With lower spout. Distance from wall: 273 mm.

Miscelatore monocomando a muro per cucina

Con canna inferiore. Distanza dal muro: 273 mm.

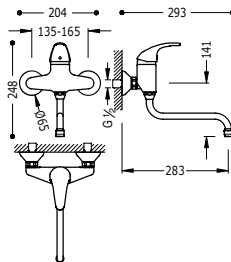

Wall-mounted single-handle kitchen mixer tap

172317

108,00

With lower spout. Distance from wall: 283 mm.

Miscelatore monocomando a muro per cucina

Con canna inferiore. Distanza dal muro: 283 mm.

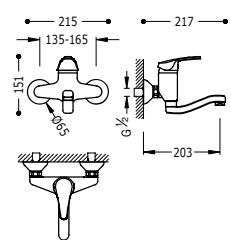

Wall-mounted single-handle kitchen mixer tap

07032003

100,00

With lower spout. Distance from wall: 203 mm.

Miscelatore monocomando a muro per cucina

Con canna inferiore. Distanza dal muro: 203 mm.



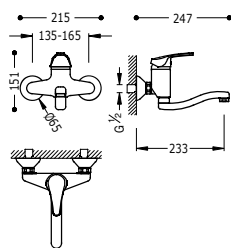

Wall-mounted single-handle kitchen mixer tap

17041802

105,00

With lower spout. Distance from wall: 233 mm.

Miscelatore monocomando a muro per cucina

Con canna inferiore. Distanza dal muro: 233 mm.

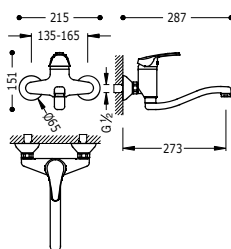

Wall-mounted single-handle kitchen mixer tap

17032002

107,00

With lower spout. Distance from wall: 273 mm.

Miscelatore monocomando a muro per cucina

Con canna inferiore. Distanza dal muro: 273 mm.

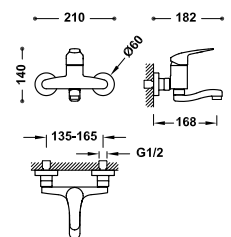

Wall-mounted single-handle kitchen mixer tap

21632010

84,00

With lower spout. Distance from wall: 168 mm.

Miscelatore monocomando a muro per cucina

Con canna inferiore. Distanza dal muro: 168 mm.

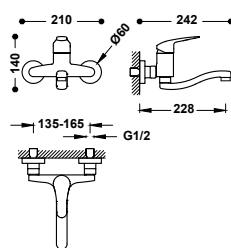

Wall-mounted single-handle kitchen mixer tap

21632020

86,00

With lower spout. Distance from wall: 228 mm.

Miscelatore monocomando a muro per cucina

Con canna inferiore. Distanza dal muro: 228 mm.

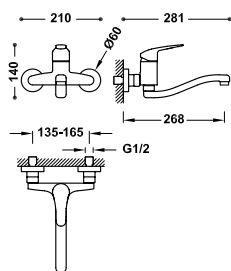

Wall-mounted single-handle kitchen mixer tap

21632030

88,00

With lower spout. Distance from wall: 268 mm.

Miscelatore monocomando a muro per cucina

Con canna inferiore. Distanza dal muro: 268 mm.



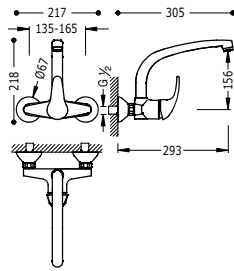

Wall-mounted single-handle kitchen mixer tap

172420

118,00

With upper spout. Distance from wall: 293 mm.

Miscelatore monocomando a muro per cucina

Con canna superiore. Distanza dal muro: 293 mm.

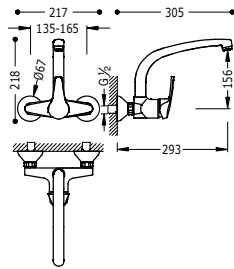

Wall-mounted single-handle kitchen mixer tap

17033202

118,00

With upper spout. Distance from wall: 293 mm.

Miscelatore monocomando a muro per cucina

Con canna superiore. Distanza dal muro: 293 mm.

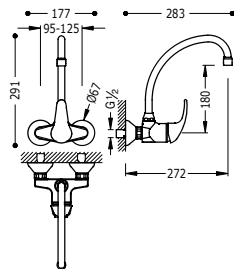

Wall-mounted single-handle kitchen mixer tap

172218

108,00

With upper spout. Special offset. Distance from wall: 272 mm.

Miscelatore monocomando a muro per cucina

Con canna superiore. Eccentricità speciale. Distanza dal muro: 272 mm.

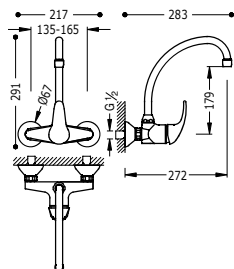

Wall-mounted single-handle kitchen mixer tap

172418

98,00

With upper spout. Distance from wall: 272 mm.

Miscelatore monocomando a muro per cucina

Con canna superiore. Distanza dal muro: 272 mm.

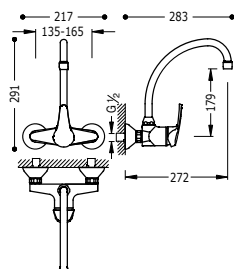

Wall-mounted single-handle kitchen mixer tap

17031802

102,00

With upper spout. Distance from wall: 272 mm.

Miscelatore monocomando a muro per cucina

Con canna superiore. Distanza dal muro: 272 mm.



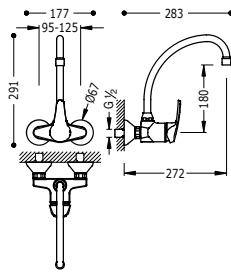

Wall-mounted single-handle kitchen mixer tap

17021802

97,00

With upper spout. Special offset. Distance from wall: 272 mm.

Miscelatore monocomando a muro per cucina

Con canna superiore. Eccentricità speciale. Distanza dal muro: 272 mm.



9 - 12

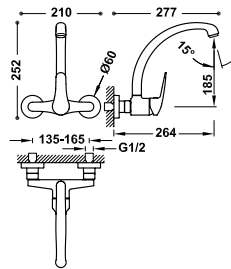

Wall-mounted single-handle kitchen mixer tap

21642010

98,00

With upper spout. Distance from wall: 264 mm.

Miscelatore monocomando a muro per cucina

Con canna superiore. Distanza dal muro: 264 mm.



13 - 16

INDUSTRIAL / INDUSTRIALI

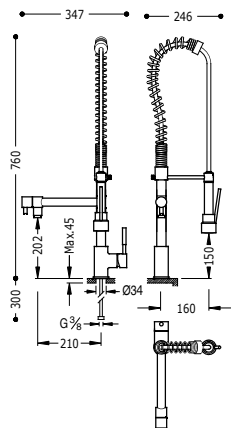

Industrial double-single lever kitchen mixer with dual function pull-out spout

130495

455,00

With G3/8 flexible hoses.

Miscelatore monocomando doppio con doccetta estraibile per cucina industriale

Con flessibili di alimentazione G3/8.



9134592

9134282

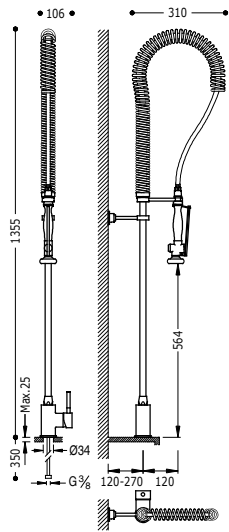

Industrial single lever kitchen mixer with dual function pull-out spout

130484

325,00

With G3/8 flexible hoses.

Miscelatore monocomando con doccetta estraibile per cucina industriale

Con flessibili di alimentazione G3/8.

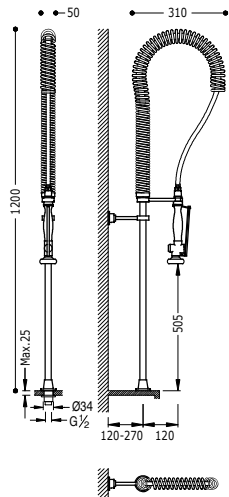

Pull-out spout for industrial kitchen with water outlet on sink surface

130481

275,00

Without accessories. Complement with a pedal tap or concealed single-handle mixer tap.

Doccetta estraibile per cucina industriale con presa d'acqua sulla superficie del lavello

Senza complementi. Da completare con un miscelatore a pedale o un miscelatore monocomando a incasso.



Pedal tap with 2-outlet mixer.
Miscelatore a pedale a 2 getti

112370

230,00

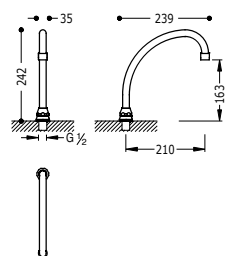

Swivel spout for pedal tap

112441

40,00

With link.

Canna girevole per miscelatore a pedale

Con collegamento.



Pedal tap with 2-outlet mixer.
Miscelatore a pedale a 2 getti

112370

230,00



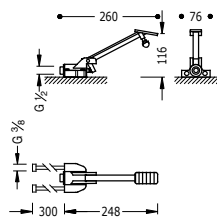

Pedal tap with 2-outlet mixer.

112370

230,00

Press the pedal to progressively increase the water temperature with a constant flow.

Miscelatore a pedale a 2 getti

Premendo il pedale aumenta progressivamente la temperatura dell'acqua, sempre con un flusso costante.

TAPS FOR VARIOUS USES / RUBINETTI PER USI DIVERSI

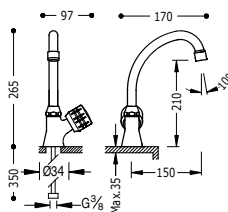

Tap with 1 water outlet and lateral handle for office or utility room

123306

52,00

With G3/8 flexible shower hose.

Miscelatore monoacqua con manopola laterale per zona pranzo o lavatoio

Con flessibili di alimentazione G3/8.

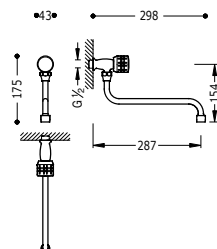

Wall-mounted tap with 1 water outlet for office or utility room

123505

40,00

With lower spout. Distance from wall: 287 mm.

Miscelatore a muro per o zona pranzo o lavatoio

Con canna inferiore. Distanza dal muro: 287 mm.

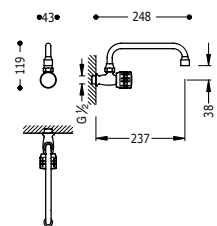

Wall-mounted tap with 1 water outlet for office or utility room

123506

40,00

With upper spout. Distance from wall: 237 mm.

Miscelatore a muro per o zona pranzo o lavatoio

Con canna superiore. Distanza dal muro: 237 mm.







PUBLIC SPACES

STRUTTURE COLLETTIVE



468 Outdoor taps
Rubinetti da esterno

470 Timed taps
Rubinetti temporizzati

476 Medical taps
Rubinetti per centri medici

477 Hair salon taps
Rubinetti per negozio da parrucchiere

478 Taps for various uses
Rubinetti per usi diversi



OUTDOOR TAPS / RUBINETTI DA ESTERNO

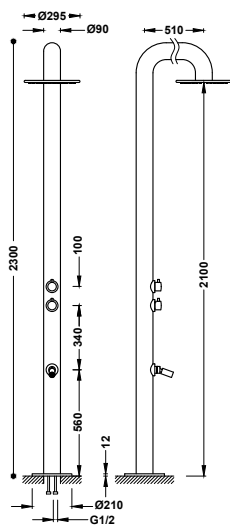

316 stainless steel garden or swimming pool shower

13499504

1.780,00

- Made from 316 stainless steel.
- Treated for outdoor use to prevent deterioration.
- With floor water supply.
- Ø 295 mm fixed shower head with anti-limescale system.
- Adjustable lower shower head for washing feet.
- Handle for adjusting the water flow from both shower heads, and another for controlling the temperature.

Colonna doccia per giardino o piscina in acciaio inossidabile 316

- *Fabbricata in acciaio inossidabile 316.*
- *Sottoposta a trattamento per esterni che ne impedisce il deterioramento.*
- *Con presa d'acqua a terra.*
- *Soffione doccia fissa Ø 295 mm. con sistema anticalcare.*
- *Rubinetto lavapiedi con supporto orientabile.*
- *Dispone di un comando per regolare il flusso di entrambe le uscite e di un altro per controllare la temperatura.*

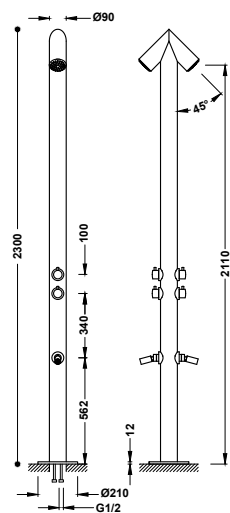

316 stainless steel garden or swimming pool double shower

13499502

1.675,00

- Made from 316 stainless steel.
- Treated for outdoor use to prevent deterioration.
- With floor water supply.
- Two shower heads with anti-limescale system.
- Two adjustable lower shower heads for washing feet.
- Both shower heads feature a valve for adjusting the water flow from both heads, and another for controlling the temperature.

Colonna con doppia doccia per giardino o piscina in acciaio inossidabile 316

- *Fabbricata in acciaio inossidabile 316.*
- *Sottoposta a trattamento per esterni che ne impedisce il deterioramento.*
- *Con presa d'acqua a terra.*
- *Due soffioni con sistema anticalcare.*
- *Due rubinetti lavapiedi con supporto orientabile.*
- *Ogni soffione dispone di un comando per regolare il flusso di entrambe le uscite e di un altro per controllare la temperatura.*

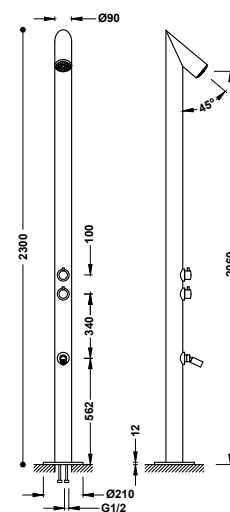

316 stainless steel garden or swimming pool shower

13499501

1.570,00

- Made from 316 stainless steel.
- Treated for outdoor use to prevent deterioration.
- With floor water supply.
- Shower head with anti-limescale system.
- Adjustable lower shower head for washing feet.
- Handle for adjusting the water flow from both shower heads, and another for controlling the temperature.

Colonna doccia per giardino o piscina in acciaio inossidabile 316

- *Fabbricata in acciaio inossidabile 316.*
- *Sottoposta a trattamento per esterni che ne impedisce il deterioramento.*
- *Con presa d'acqua a terra.*
- *Soffione con sistema anticalcare.*
- *Rubinetto lavapiedi con supporto orientabile.*
- *Dispone di un comando per regolare il flusso di entrambe le uscite e di un altro per controllare la temperatura.*



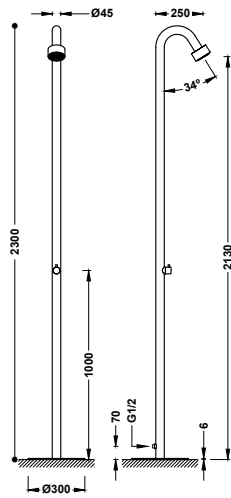

1 water shower column for the garden or swimming pool in 316 stainless steel

13499503

1.045,00

- Made from 316 stainless steel.
- Treated for outdoor use to prevent deterioration.
- Outdoor fitting with connection for hose.
- Upper shower head with anti-limescale system.

Colonna doccia a 1 soffione in acciaio inox 316 per giardino o piscina

- Fabbricata in acciaio inossidabile 316.
- Sottoposta a trattamento per esterni che ne impedisce il deterioramento.
- Presa esterna con collegamento per tubo.
- Doccia superiore con sistema anticalcare.

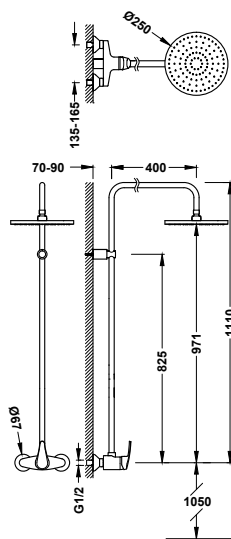

1 water outlet wall-fitted single-handle mixer tap set for garden or swimming pool

07099501

313,00

- Adjustable shower head: Ø 250 mm.

Set miscelatore monocomando a muro monoacqua per giardino o piscina

- Soffione doccia orientabile: Ø 250 mm.

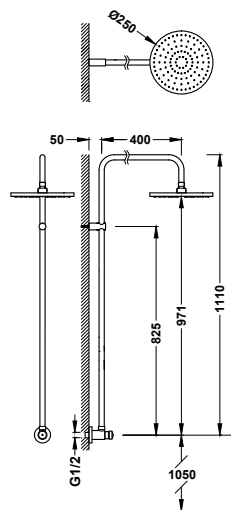
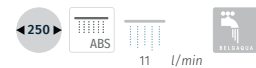

1 water outlet wall-mounted timed shower mixer tap set

01299601

273,00

- Adjustable shower head: Ø 250 mm.

Set miscelatore temporizzato a muro monoacqua per giardino o piscina

- Soffione doccia orientabile: Ø 250 mm.



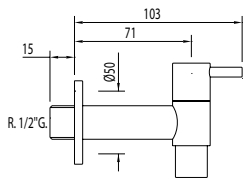

Wall-mounted tap with 1 water outlet for garden with aerator.

03450101

26,00

Miscelatore monoacqua a muro per giardino con aeratore.

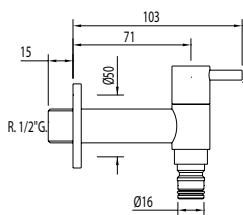

Wall-mounted tap with 1 water outlet and quick hose connection

03450102

28,00

Miscelatore monoacqua a muro con collegamento rapido a tubo

SINK TIMER TAP / RUBINETTI TEMPORIZZATI PER LAVABO

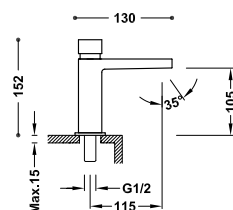

Timed flow basin tap

20511201

119,00

Automatic shut-off: 6 sec. Water flow: 0.7 litres per cycle.

Miscelatore temporizzato monoacqua per lavabo
Chiusura automatica: 6 sec. Flusso: 0,7 l x ciclo.

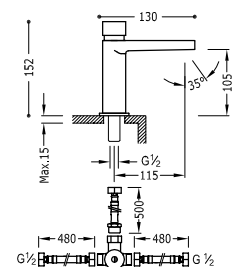

Timed flow basin tap and pre-mixing system

20511202

161,00

Automatic shut-off: 6 sec. Includes a 2-outlet mixer valve with flexible hoses. Water flow: 0.7 litres per cycle.

Miscelatore temporizzato monoacqua con sistema di premiscelazione per lavabo

Chiusura automatica: 6 sec. È inclusa una valvola miscelatrice a 2 getti con tubi flessibili. Flusso: 0,7 l x ciclo.

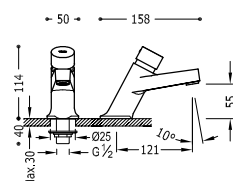

Timed flow basin tap

01210303

97,00

Automatic shut-off: 4,7 sec. Water flow: 0.4 litres per cycle.

Miscelatore temporizzato monoacqua per lavabo
Chiusura automatica: 4,7 sec. Flusso: 0,4 l x ciclo.



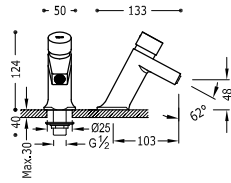

Timed flow basin tap

01210302

93,00

Automatic shut-off: 5,7 sec. Water flow: 0.5 litres per cycle.

Miscelatore temporizzato monoacqua per lavabo

Chiusura automatica: 5,7 sec. Flusso: 0,5 l x ciclo.

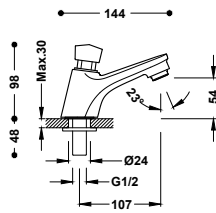

Timed flow basin tap

21210301

61,00

G1/2 male threaded connection. Automatic shut-off: 4,5 sec. Water flow: 0.5 litres per cycle.

Miscelatore temporizzato monoacqua per lavabo

Attacco filettato maschio da G1/2. Chiusura automatica: 4,5 sec. Flusso: 0,5 l x ciclo.

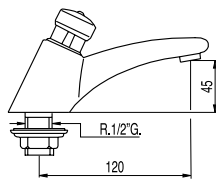

Timed flow basin tap

112103

103,00

G1/2 male threaded connection. Automatic shut-off: 10,8 sec. Water flow: 1.2 litres per cycle.

Miscelatore temporizzato monoacqua per lavabo

Attacco filettato maschio da G1/2. Chiusura automatica: 10,8 sec. Flusso: 1,2 l x ciclo.

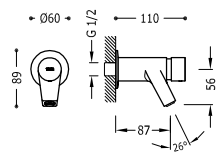

Wall-mounted timed flow basin tap

01210002

83,00

G1/2 male threaded connection. Automatic shut-off: 6 sec. Water flow: 0.5 litres per cycle.

Miscelatore temporizzato a muro monoacqua per lavabo

Attacco filettato maschio G1/2. Chiusura automatica: 6 sec. Flusso: 0,5 l x ciclo.

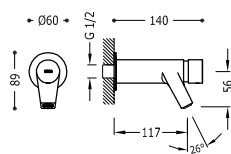

Wall-mounted timed flow basin tap

01210003

86,00

G1/2 male threaded connection. Automatic shut-off: 6 sec. Water flow: 0.5 litres per cycle.

Miscelatore temporizzato a muro monoacqua per lavabo

Attacco filettato maschio G1/2. Chiusura automatica: 6 sec. Flusso: 0,5 l x ciclo.



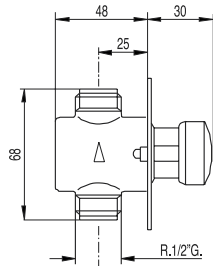

Concealed timed urinal flush tap

01220801

80,00

Concealed body included. G1/2 threaded connection. Automatic shut-off: 4 sec. Water flow: 0.7 litres per cycle.

Miscelatore di scarico temporizzato a incasso monoacqua per orinatoio

Corpo a incasso incluso. Attacco filettato G1/2. Chiusura automatica: 4 sec. Flusso: 0,7 l x ciclo.

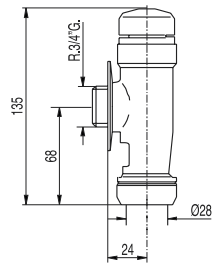

Wall-mounted timed urinal flush tap

112205

104,00

G3/4 male threaded connection. Water outlet for 26x28 hose. Automatic shut-off: 3,5 sec. Water flow: 5.3 litres per cycle.

Miscelatore di scarico temporizzato a muro monoacqua per orinatoio

Attacco filettato maschio G3/4. Uscita dell'acqua per tubo 26x28. Chiusura automatica: 3,5 sec. Flusso: 5,3 l x ciclo.

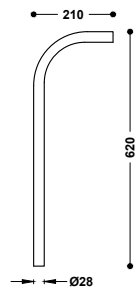

Drainage pipe for wall-mounted timed urinal tap

13420503

66,00

Tubo di scarico per miscelatore temporizzato a muro di orinatoio

SHOWER TIMER TAP / RUBINETTI TEMPORIZZATI PER DOCCIA

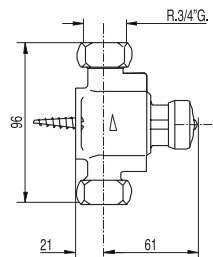

Wall-mounted timed shower tap

112167

103,00

Automatic shut-off: 15 sec. Water flow: 16 l/min.

Miscelatore temporizzato a muro monoacqua per doccia

Chiusura automatica: 15 sec. Flusso: 16 l/min.

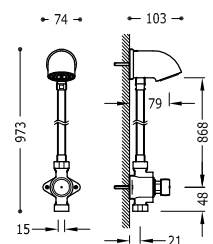

1-way wall-mounted thermostatic shower mixer tap set

112161

211,00

Automatic flow regulator built into the shower head. Water flow: 8-10 l/min.

Set di miscelatore temporizzato a muro 1 getto per doccia

Regolatore di flusso automatico incorporato nel soffione. Flusso: 8-10 l/min.



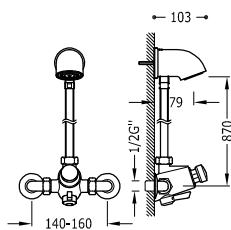

Wall-mounted timed shower mixer tap set with temperature selector

112163

464,00

Automatic flow regulator built into the shower head. Water flow: 8-10 l/min. Opposite inlets with extendable connections and non-return valves.

Set di miscelatore temporizzato a muro con selettore di temperatura per doccia

Regolatore di flusso automatico incorporato nel soffione. Flusso: 8-10 l/min. Ingressi opposti con raccordi estensibili e valvole di ritegno.

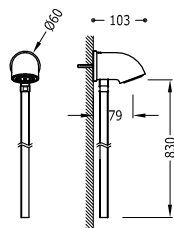

Wall-mounted shower head with connection pipe

11216150

131,00

With connection pipe. Automatic flow regulator built into the shower head. Water flow: 8-10 l/min.

Soffione a muro per doccia con tubo di collegamento

Con tubo di collegamento. Regolatore di flusso automatico incorporato nel soffione. Flusso: 8-10 l/min.

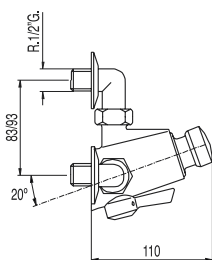

Wall-mounted timed shower mixer tap with temperature selector

112162

725,00

Opposite inlets with extendable connections and non-return valves. Water flow: 16 l/min.

Miscelatore temporizzato a muro con selettore di temperatura per doccia

Ingressi opposti con raccordi estensibili e valvole di ritegno. Flusso: 16 l/min.

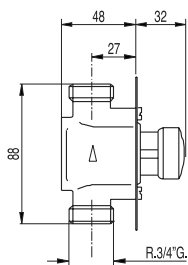

Concealed timed shower mixer tap

112178

94,00

G3/4 threaded outlet and inlet. Water flow: 20 l/min.

Miscelatore temporizzato a incasso monoacqua per doccia

Ingresso e uscita con filettatura G3/4. Flusso: 20 l/min.

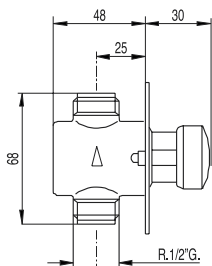

Concealed timed shower mixer tap

112177

80,00

G1/2 threaded outlet and inlet. Water flow: 16 l/min.

Miscelatore temporizzato a incasso monoacqua per doccia

Ingresso e uscita con filettatura G1/2. Flusso: 16 l/min.

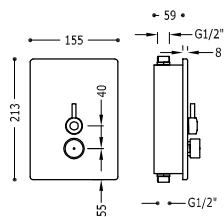

Concealed timed shower mixer tap with temperature selector

01217901

630,00

2 inlets and 1 outlet with G1/2 thread.

Miscelatore temporizzato a incasso con selettore di temperatura per doccia

2 ingressi e a uscita con filettatura G1/2.

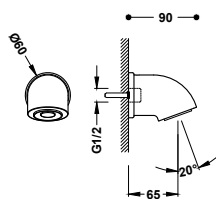

Anti-vandal wall-mounted shower head

13416803

103,00

Automatic flow regulator built into the shower head. Water flow: 6 l/min.

Soffione a muro antivandalico per doccia

Regolatore di flusso automatico incorporato nel soffione. Flusso: 6 l/min.

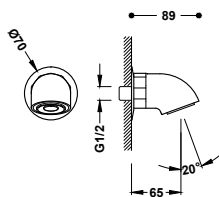

Wall-mounted shower head

13416703

80,00

Automatic flow regulator built into the shower head. Water flow: 8-10 l/min. G1/2 male threaded connection.

Soffione a muro per doccia

Regolatore di flusso automatico incorporato nel soffione. Flusso: 8-10 l/min. Attacco filettato maschio G1/2.



MEDICAL TAPS / RUBINETTI PER CENTRI MEDICI

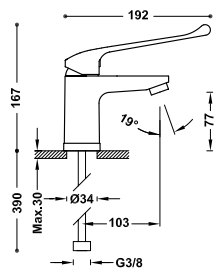

Single-handle medical mixer tap

2161030111

97,00

With G3/8 flexible hoses.

Miscelatore monocomando doccia medico

Con flessibili di alimentazione G3/8.

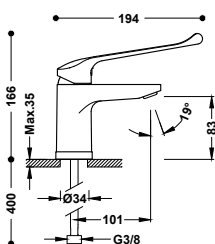

Single-handle medical mixer tap with Cold-tres

2161041011BR1

100,00

With G3/8 flexible hoses.

Miscelatore monocomando doccia medico con Cold-tres

Con flessibili di alimentazione G3/8.

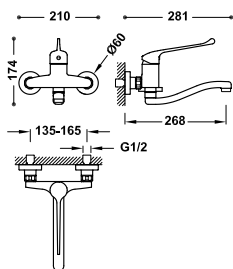

Wall-mounted single-handle medical mixer tap

2163200311

164,00

With lower spout. Distance from wall: 268 mm.

Miscelatore monocomando a muro medico

Con canna inferiore. Distanza dal muro: 268 mm.

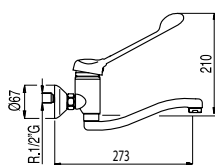

Wall-mounted single-handle medical mixer tap

17231811

200,00

With lower spout. Distance from wall: 273 mm.

Miscelatore monocomando a muro medico

Con canna inferiore. Distanza dal muro: 273 mm.

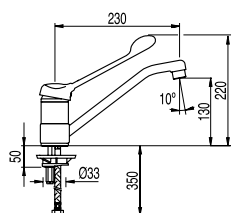

Single-handle medical mixer tap

17233311

154,00

With G3/8 flexible hoses.

Miscelatore monocomando doccia medico

Con flessibili di alimentazione G3/8.



Medical lever for single-handle mixer tap

9134011

45,00

For ref.: 17231811, 17233311.

Leva medica per miscelatore monocomando

Per rif.: 17231811, 17233311.

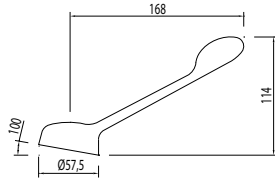

Wall-mounted single-handle medical shower mixer tap

2151671011

125,00

Anti-limescale hand shower. Articulated support for hand shower. Metal hose.

Miscelatore monocomando a muro medico per doccia

Doccino anticalcare. Supporto articolato per doccino. Flessibile in metallo.

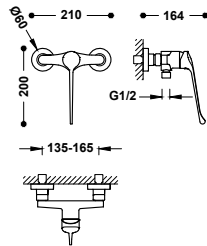

Wall-mounted thermostatic shower mixer tap with ergonomic handles

19026410

235,00

Without accessories. Suitable for people with physical disabilities.

Miscelatore termostatico a muro per doccia con leve ergonomiche

Senza complementi. Indicato per persone a mobilità ridotta.

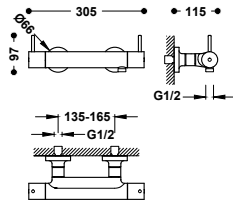

Wall-mounted thermostatic mixer tap for bath and shower with ergonomic handles

19027410

295,00

Without accessories. Inverter integrated into the flow regulator. Suitable for people with physical disabilities.

Miscelatore termostatico a muro per vasca e doccia con leve ergonomiche

Senza complementi. Inverter incorporato nel regolatore di flusso. Indicato per persone a mobilità ridotta.

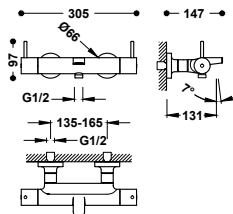

HAIR SALON TAPS / RUBINETTI PER NEGOZIO DA PARRUCCHIERE

Single-handle mixer tap for hairdresser shower

172450

130,00

With pull-out hand shower.

Miscelatore monocomando per lavatesta parrucchieri

Con doccino estraibile.

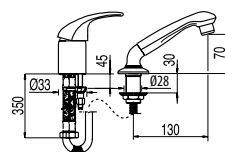

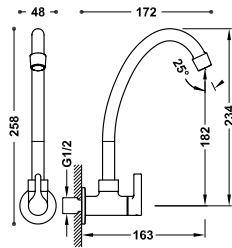

Wall-mounted tap with 1 water outlet for office or utility room

21550601

20,00

With G1/2 male threaded connection.

Miscelatore a muro per o zona pranzo o lavatoio

Con attacco filettato maschio da G1/2.

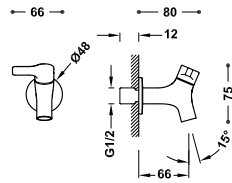

Wall-mounted tap with 1 water outlet for office or utility room

21552001

16,00

With G1/2 male threaded connection. 66 mm spout.

Miscelatore a muro per o zona pranzo o lavatoio

Con attacco filettato maschio da G1/2. Canna da 66 mm.

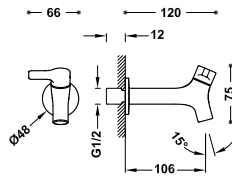

Wall-mounted tap with 1 water outlet for office or utility room

21552002

20,00

With G1/2 male threaded connection. 106 mm spout.

Miscelatore a muro per o zona pranzo o lavatoio

Con attacco filettato maschio da G1/2. Canna da 106 mm.

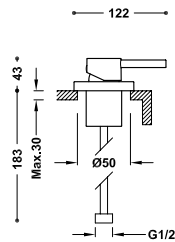

Single-lever 1-way faucet surface-mounted

03416101

80,00

Miscelatore monocomando a 1 via incassato a filo della superficie



913428810





COMPLEMENTS

COMPLEMENTI

482 Valves and drains
Valvole e scarichi

491 Siphons
Sifoni

495 Shut-off valves
Valvole di intercettazione

497 Elbow connections
Raccordi a gomito

499 Spouts
Canne

501 Escutcheons
Rosoni

502 Offsets
Eccentrici

504 WC SYSTEMS

506 Filling mechanisms
Meccanismo di riempimento

507 Flush mechanisms
Meccanismo di scarico

510 TRES CLEANER

513 Tapware cleaner
Detergente per rubinetti



SIMPLE-RAPID WASHBASIN VALVES / VALVOLE SIMPLE-RAPID PER LAVABO

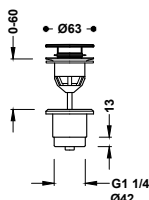

Click-clack Simple-rapid washbasin drainage valve

Suitable for washbasins with and without overflow. Click-clack operation. Plug Ø 63 mm. Simple-rapid easy installation.

Valvola di scarico Click-clack Simple-rapid per lavabo

Adatto per lavello con e senza troppopieno. Funzione Click-clack. Tappo Ø 63 mm. Simple-rapid installazione facile.

24284001	49,00
24284001NM	76,00
24284001BM	76,00
24284001AC	76,00
24284001KM	76,00
24284001KMB	76,00
24284001OR	108,00
24284001OM	108,00
24284001OP	108,00
24284001OPM	108,00
24284001LV	71,00
24284001LM	71,00
24284001AM	76,00
24284001RO	76,00
24284001NE	76,00
24284001BL	76,00

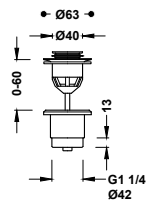

Click-clack Simple-rapid washbasin drainage valve

Suitable for washbasins with and without overflow. Click-clack operation. Plug Ø 40 mm. Simple-rapid easy installation.

Valvola di scarico Click-clack Simple-rapid per lavabo

Adatto per lavello con e senza troppopieno. Funzione Click-clack. Tappo Ø 40 mm. Simple-rapid installazione facile.

24284002	46,00
24284002NM	71,00
24284002BM	71,00
24284002AC	71,00
24284002KM	71,00
24284002KMB	71,00
24284002OR	101,00
24284002OM	101,00
24284002OP	101,00
24284002OPM	101,00
24284002LV	66,00
24284002LM	66,00
24284002NE	71,00
24284002BL	71,00

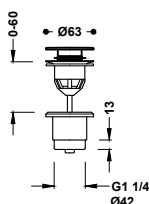

Click-clack Simple-rapid washbasin drainage valve with always-open option

Includes an adaptor that offers the option for the stopper to remain open at all times. Suitable for washbasins with and without overflow.

Valvola di scarico Click-clack Simple-rapid per lavabo con opzione sempre aperta

Include un adattatore che offre la possibilità di lasciare sempre aperto il tappo. Adatto per lavello con e senza troppopieno.

24284010	52,00
24284010NM	81,00
24284010BM	81,00
24284010AC	81,00
24284010KM	81,00
24284010KMB	81,00
24284010OR	114,00
24284010OM	114,00
24284010OP	114,00
24284010OPM	114,00
24284010LV	75,00
24284010LM	75,00
24284010AM	81,00
24284010RO	79,00
24284010NE	81,00
24284010BL	81,00

Click-clack Simple-rapid washbasin drainage valve with always-open option

Includes an adaptor that offers the option for the stopper to remain open at all times. Suitable for washbasins with and without overflow.

Valvola di scarico Click-clack Simple-rapid per lavabo con opzione sempre aperta

Include un adattatore che offre la possibilità di lasciare sempre aperto il tappo. Adatto per lavello con e senza troppopieno.

24284020	49,00
24284020NM	76,00
24284020BM	76,00
24284020AC	76,00
24284020KM	76,00
24284020KMB	76,00
24284020OR	107,00
24284020OM	107,00
24284020OP	107,00
24284020OPM	107,00
24284020LV	71,00
24284020LM	71,00
24284020NE	76,00
24284020BL	76,00

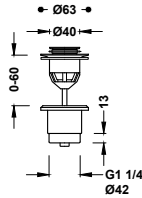

Click-clack Simple-rapid washbasin drainage valve

Suitable for washbasins with and without overflow. Click-clack operation. Plug: Ø 63.5 mm. Simple-rapid easy installation.

Valvola di scarico Click-clack Simple-rapid per lavabo

Adatto per lavello con e senza troppopieno. Funzione Click-clack. Tappo: Ø 63,5 mm. Simple-rapid installazione facile.

161840	44,00
--------	-------

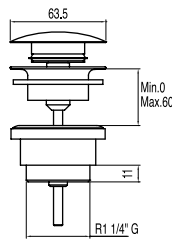

Click-clack Simple-rapid washbasin drainage valve

Suitable for washbasins with and without overflow. Click-clack operation. Plug: 68x68 mm. Simple-rapid easy installation.

Valvola di scarico Click-clack Simple-rapid per lavabo

Adatto per lavello con e senza troppopieno. Funzione Click-clack. Tappo: 68x68 mm. Simple-rapid installazione facile.

13434010	30,00
----------	-------

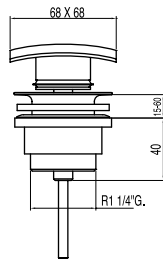

Click-clack Simple-rapid washbasin drainage valve

Suitable for washbasins with and without overflow. Click-clack operation. Plug: Ø 40 mm. Simple-rapid easy installation.

Valvola di scarico Click-clack Simple-rapid per lavabo

Adatto per lavello con e senza troppopieno. Funzione Click-clack. Tappo: Ø 40 mm. Simple-rapid installazione facile.

162840	34,00
--------	-------

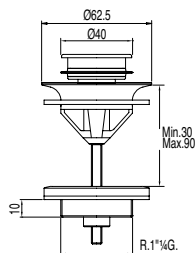

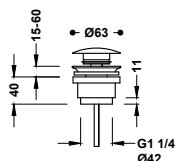

Click-clack Simple-rapid washbasin drainage valve

13454010

25,00

Suitable for washbasins with and without overflow. Click-clack operation. Plug: Ø 63 mm. Simple-rapid easy installation.

Valvola di scarico Click-clack Simple-rapid per lavabo

Adatto per lavello con e senza troppopieno. Funzione Click-clack. Tappo: Ø 63 mm. Simple-rapid installazione facile.

WASHBASIN VALVES WITHOUT OVERFLOW / VALVOLE PER LAVABO SENZA TROPPOPIENO

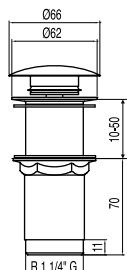

Click-clack drainage valve for washbasin without overflow

13454060

25,00

Without overflow. Click-clack operation. Plug: Ø 66 mm.

Valvola di scarico Click-clack per lavabo senza troppopieno

Senza troppopieno. Funzione Click-clack. Tappo: Ø 66 mm.

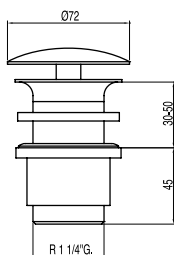

Always-open drainage valve for washbasin without overflow

13424020

29,00

Without overflow. Plug: Ø 72 mm.

Valvola di scarico sempre aperto per lavabo senza troppopieno

Senza troppopieno. Tappo: Ø 72 mm.

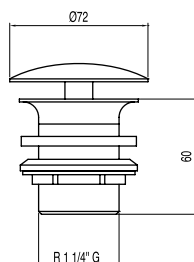

Always-open drainage valve for washbasin without overflow

13424010

23,00

Without overflow. Plug: Ø 72 mm.

Valvola di scarico sempre aperto per lavabo senza troppopieno

Senza troppopieno. Tappo: Ø 72 mm.

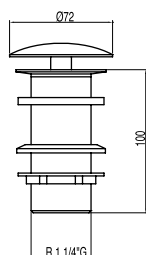

Always-open drainage valve for washbasin without overflow

13424030

24,00

Without overflow. Plug: Ø 72 mm.

Valvola di scarico sempre aperto per lavabo senza troppopieno

Senza troppopieno. Tappo: Ø 72 mm.

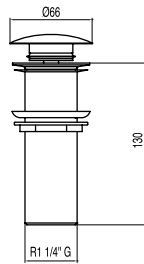

Click-clack drainage valve for washbasin without overflow

13454030

38,00

Without overflow. Click-clack operation. Plug: Ø 66 mm.

Valvola di scarico Click-clack per lavabo senza troppopieno

Senza troppopieno. Funzione Click-clack. Tappo: Ø 66 mm.

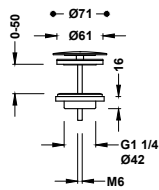

Always-open drainage valve for washbasin without overflow

134215028

19,00

Without overflow. Plug: Ø 71 mm.

Valvola di scarico sempre aperto per lavabo senza troppopieno

Senza troppopieno. Tappo: Ø 71 mm.

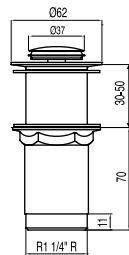

Click-clack drainage valve for washbasin without overflow

13454050

22,00

Without overflow. Click-clack operation. Plug: Ø 37 mm.

Valvola di scarico Click-clack per lavabo senza troppopieno

Senza troppopieno. Funzione Click-clack. Tappo: Ø 37 mm.

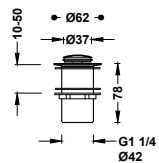

Click-clack drainage valve for washbasin without overflow

13454070

18,00

Without overflow. Click-clack operation. Plug: Ø 37 mm.

Valvola di scarico Click-clack per lavabo senza troppopieno

Senza troppopieno. Funzione Click-clack. Tappo: Ø 37 mm.

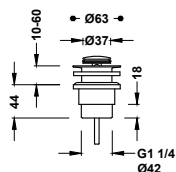

Click-clack drainage valve for washbasin without overflow

134215026

13,00

Without overflow. Click-clack operation. Plug: Ø 37 mm.

Valvola di scarico Click-clack per lavabo senza troppopieno

Senza troppopieno. Funzione Click-clack. Tappo: Ø 37 mm.



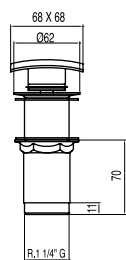

Click-clack drainage valve for washbasin without overflow

13434120

30,00

Without overflow. Click-clack operation. Plug: 68x68 mm.

Valvola di scarico Click-clack per lavabo senza troppopieno

Senza troppopieno. Funzione Click-clack. Tappo: 68x68 mm.

WASHBASIN VALVES WITH OVERFLOW / VALVOLE PER LAVABO CON TROPPOPIENO

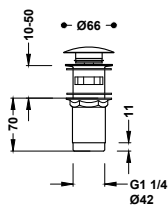

Click-clack drainage valve for washbasin with overflow

13454160

25,00

With overflow. Click-clack operation. Plug: Ø 66 mm.

Valvola di scarico Click-clack per lavabo con troppopieno

Con troppopieno. Funzione Click-clack. Tappo: Ø 66 mm.

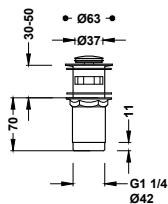

Click-clack drainage valve for washbasin with overflow

13454110

22,00

With overflow. Click-clack operation. Plug: Ø 37 mm.

Valvola di scarico Click-clack per lavabo con troppopieno

Con troppopieno. Funzione Click-clack. Tappo: Ø 37 mm.

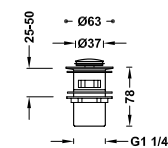

Click-clack drainage valve for washbasin with overflow

13454190

18,00

With overflow. Click-clack operation. Plug: Ø 37 mm.

Valvola di scarico Click-clack per lavabo con troppopieno

Con troppopieno. Funzione Click-clack. Tappo: Ø 37 mm.

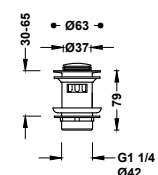

Click-clack drainage valve for washbasin with overflow

134215025

19,00

With overflow. Click-clack operation. Plug: Ø 37 mm.

Valvola di scarico Click-clack per lavabo con troppopieno

Con troppopieno. Funzione Click-clack. Tappo: Ø 37 mm.

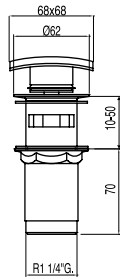

Click-clack drainage valve for washbasin with overflow

13434020

30,00

With overflow. Click-clack operation. Plug: 68x68 mm.

Valvola di scarico Click-clack per lavabo con troppopieno

Con troppopieno. Funzione Click-clack. Tappo: 68x68 mm.

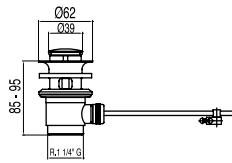

Automatic drainage valve for washbasin with overflow

13474310

18,00

With overflow. Plug: Ø 39 mm.

Valvola di scarico automatico per lavabo con troppopieno

Con troppopieno. Tappo: Ø 39 mm.

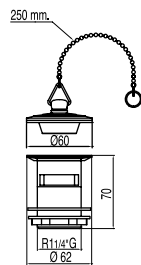

Drainage valve with plug and chain for washbasin with overflow

13474320

17,00

250 mm chain.

Valvola di scarico con tappo e catena per lavabo con troppopieno

Catena di 250 mm.

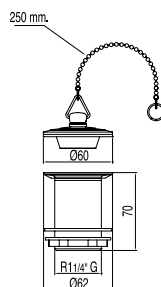

Drainage valve with plug and chain for washbasin without overflow

13474330

17,00

250 mm chain.

Valvola di scarico con tappo e catena per lavabo senza troppopieno

Catena di 250 mm.

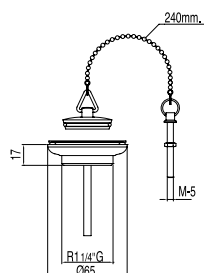

Drainage set with drain plate, plug, chain and screw for washbasin, bidet and sink

13463910

13,00

240 mm chain.

Kit di scarico con filtro, tappo, catena e vite per lavabo, bidet e lavello

Catena di 240 mm.



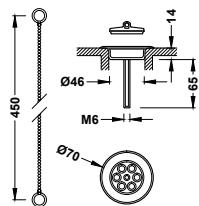

Flat drain housing with chain and cap for washbasin, bidet and sink

Chain: 450 mm. Housing: Ø 70 mm. Metal cap.

Piletta di scarico piatta con catena e tappo per lavabo, bidet e lavello

Catena: 450 mm. Piletta: Ø 70 mm. Tappo in metallo.

03474601	32,00
03474601AC	50,00
03474601OR	70,00
03474601OM	70,00
9134746051	46,00
03474601LM	46,00

ACCESSORIES FOR VALVES / COMPLEMENTI PER VALVOLE

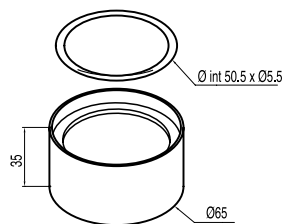

Separator for drainage valve

For counter-top washbasins. Diameter: Ø 65 mm. Height: 35 mm.

Distanziatore per valvola di scarico.

Per lavelli da appoggio. Diametro: Ø 65 mm. Altezza: 35 mm.

916110348	36,00
-----------	-------

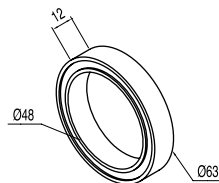

Separator for drainage valve

For counter-top washbasins. Diameter: Ø 63 mm. Height: 12 mm.

Distanziatore per valvola di scarico.

Per lavelli da appoggio. Diametro: Ø 63 mm. Altezza: 12 mm.

13463310	14,00
----------	-------

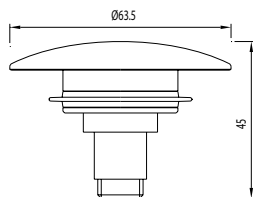

Plug for Click-clack drainage valve

Click-clack operation. Plug: Ø 63.5 mm. For ref.: 161840.

Tappo per valvola di scarico Click-clack

Funzione Click-clack. Tappo: Ø 63.5 mm. Per rif.: 161840.

916184060	28,00
-----------	-------

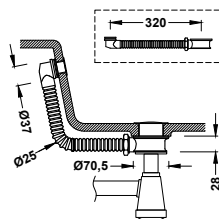

Adapter for glass or stainless steel washbasin without overflow

With overflow. Hose: 320 mm.

Adattatore per lavabi in vetro o acciaio inox senza troppopieno

Con troppopieno. Tubo flessibile: 320 mm.

13463450	23,00
----------	-------

SHOWER OR BATH DRAINS / SCARICHI PER DOCCIA O VASCA

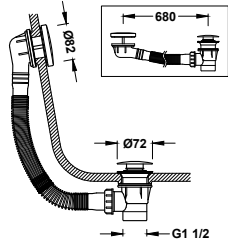

Click-clack drainage valve with overflow for bath

Plug: Ø 72 mm. Flexible pipe: max. 680 mm.

Valvola di scarico Click-clack per vasca

Tappo: Ø 72 mm. Tubo flessibile: max. 680 mm.

13453420	32,00
03453420NM	50,00
03453420BM	50,00
03453420AC	50,00
03453420KM	50,00
03453420KMB	50,00
03453420OR	70,00
03453420OM	70,00
03453420OP	70,00
03453420OPM	70,00
03453420LV	46,00
03453420LM	46,00

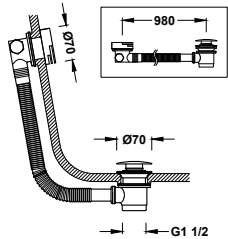

Round Click-clack drainage and fill valve with overflow for bath

Plug: Ø 70 mm. Flexible pipe: max. 980 mm.

Valvola di scarico rotondo Click-clack Simple-rapid e di riempimento con troppopieno per vasca

Tappo: Ø 70 mm. Tubo flessibile: max. 980 mm.

13453430	69,00
03453430NM	107,00
03453430BM	107,00
03453430AC	107,00
03453430KM	107,00
03453430KMB	107,00
03453430OR	152,00
03453430OM	152,00
03453430OP	152,00
03453430OPM	152,00
03453430LV	100,00
03453430LM	100,00



Overflow drain / Troppopieno
Cascade / Cascata

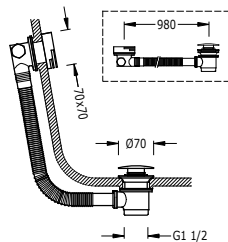

Square Click-clack drainage and fill valve with overflow for bath

Plug: Ø 70 mm. Flexible pipe: max. 980 mm.

Valvola di scarico quadrato Click-clack Simple-rapid e di riempimento con troppopieno per vasca

Tappo: Ø 70 mm. Tubo flessibile: max. 980 mm.

13453440	95,00
03453440NM	146,00
03453440AC	146,00
03453440OR	208,00
03453440OM	208,00



Overflow drain / Troppopieno
Cascade / Cascata

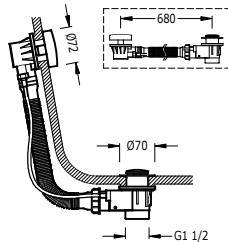

Automatic drainage valve for bath with overflow

With overflow. The drain valve can be opened and closed by turning the handle on the drainage pipe. Plug: Ø 43 mm. Flexible pipe: max. 680 mm.

Valvola di scarico automatico per vasca con troppopieno

Con troppopieno. È possibile aprire e chiudere la valvola di scarico ruotando il volante situato sul canale di scarico. Tappo: Ø 43 mm. Tubo flessibile: max. 680 mm.

13453410	35,00
----------	-------



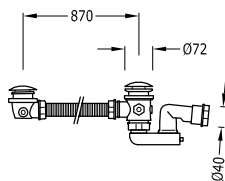

Click-clack drainage valve for bath with overflow and drainage point

134445

100,00

With water drainage point for tank kit. Plug \varnothing 72 mm.

Valvola di scarico Click-clack per vasca con troppopieno e presa drenaggio

Con presa drenaggio acqua per kit contenitore. Tappo: \varnothing 72 mm.

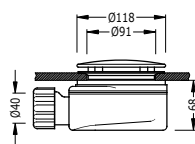

Inspectionable drain trap drain for shower tray

104841

42,00

With built-in drain trap. Plug: \varnothing 118 mm. Drainage volume: 62 l/min.

Scarico sifonato ispezionabile per piatto doccia

Con sifone incorporato. Tappo: \varnothing 118 mm. Volume di scarico: 62 l/min.

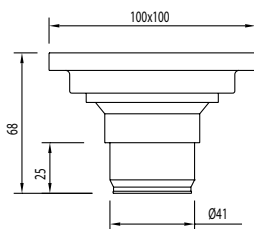

Inspectionable drain for unfinished shower tray

03474007

25,00

Drain trap not required. Material: Brass

Piletta ispezionabile per piatto doccia in muratura

Non è necessario il sifone. Materiale: Ottone

IDEAL FOR BUILT-IN SHOWER TRAYS

- Minimum depth
- Does not require a siphon
- Eliminates bad odors
- Inspectable
- Made of brass

IDEALE PER PIATTI DOCCIA IN MURATURA

- Profondità minima
- Non richiede sifone
- Elimina cattivi odori
- Ispezionabile
- Fabbricato in ottone

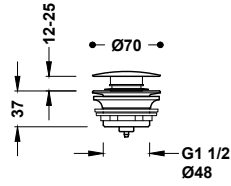

Click-clack drainage valve for bath

Click-clack operation. Plug: Ø 70 mm.

Valvola di scarico Click-clack Simple-rapid per vasca

Funzione Click-clack. Tappo: Ø 70 mm.

13474010	20,00
13474010NM	31,00
13474010BM	31,00
13474010AC	31,00
13474010KM	31,00
13474010KMB	31,00
13474010OR	44,00
13474010OM	44,00
13474010OP	44,00
13474010PM	44,00

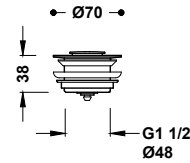

Click-clack drainage valve with hidden plug for bath

Click-clack operation. Plug: Ø 36 mm.

Valvola di scarico Click-clack con tappo occulto per vasca

Funzione Click-clack. Tappo: Ø 36 mm.

134215027	14,00
-----------	-------

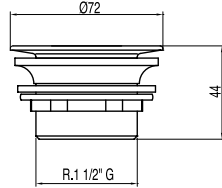

Drain for utility room or similar

Plug: Ø 72 mm.

Scarico per lavatoio o simile

Tappo: Ø 72 mm.

13474020	9,00
----------	------

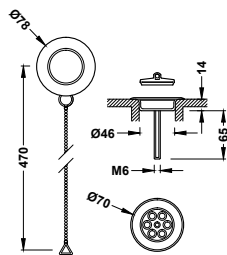

Flat drain housing with chain and cap for washbasin, bidet and sink

Chain: 450 mm. Housing: Ø 70 mm. Metal cap.

Piletta di scarico piatta con catena e tappo per lavabo, bidet e lavello

Catena: 450 mm. Piletta: Ø 70 mm. Tappo in metallo.

03474501	40,00
03474501AC	62,00
03474501OR	104,00
03474501OM	104,00
9134745051	58,00
03474501LM	58,00

SIPHONS / SIFONI

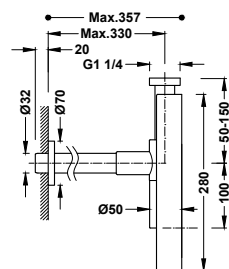

Square telescopic and inspectionable drain trap with skirt for washbasin

Sifone telescopico quadrato ispezionabile con calotta per lavabo

10710342	200,00
10710342NM	310,00
10710342BM	310,00
10710342AC	310,00
10710342KM	310,00
10710342KMB	310,00
10710342OR	440,00
10710342OM	440,00
10710342OP	440,00
10710342OPM	440,00

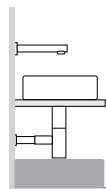

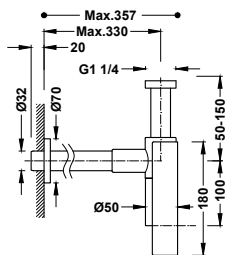

Round telescopic and inspectionable drain trap with skirt for washbasin

Sifone telescopico rotondo ispezionabile con calotta per lavabo

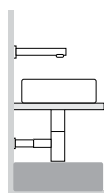

16110342	170,00
16110342NM	264,00
16110342BM	264,00
16110342AC	264,00
16110342KM	264,00
16110342KMB	264,00
16110342OR	374,00
16110342OM	374,00
16110342OP	374,00
16110342OPM	374,00

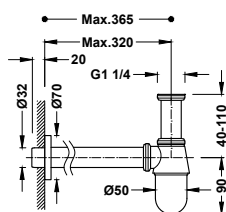

Telescopic and inspectionable bottle-type drain trap for washbasin

Sifone telescopico a bottiglia ispezionabile con calotta per lavabo

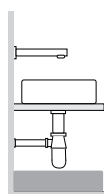

13463430	32,00
03463430NM	74,00
03463430BM	74,00
03463430AC	74,00
03463430KM	74,00
03463430KMB	74,00
03463430OR	198,00
03463430OM	198,00
03463430OP	198,00
03463430OPM	198,00
03463430LV	74,00
03463430LM	74,00

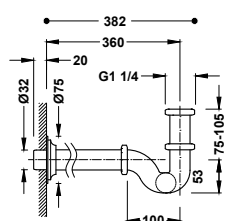

Telescopic drain trap with inspection point for washbasin

Sifone telescopico con piletta per lavabo

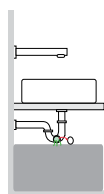

13463820	34,00
03463820NM	78,00
03463820BM	78,00
03463820AC	78,00
03463820KM	78,00
03463820KMB	78,00
03463820OR	211,00
03463820OM	211,00
03463820OP	211,00
03463820OPM	211,00
03463820LV	78,00
03463820LM	78,00

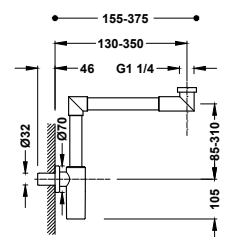

Telescopic elbow drain trap for washbasin

Sifone telescopico a gomito per lavabo

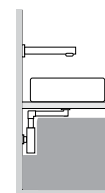

16110362	181,00
----------	--------

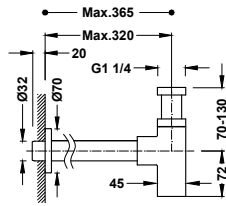

Telescopic drain trap for washbasin

- 13463420 63,00
- 13463420NM 98,00

Sifone telescopico per lavabo

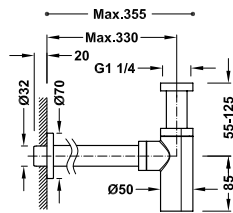
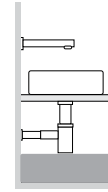

Telescopic drain trap for washbasin

- 13463410 43,00
- 13463410NM 67,00

Sifone telescopico per lavabo

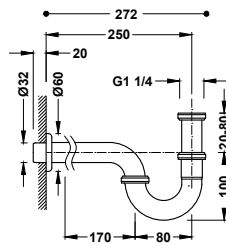
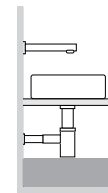

Telescopic rotating drain trap for washbasin

Rotating outlet pipe. Ideal for any type of installation.

Sifone telescopico girevole per lavabo

Beccuccio girevole. Ideale per qualsiasi installazione.

- 13463810 22,00

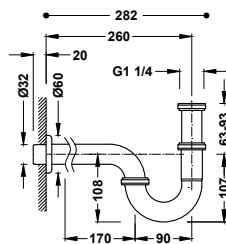
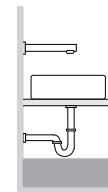

Telescopic rotating drain trap for washbasin

Rotating outlet pipe. Ideal for any type of installation.

Sifone telescopico girevole per lavabo

Beccuccio girevole. Ideale per qualsiasi installazione.

- 134215024 16,00

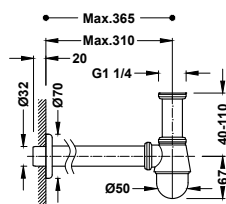
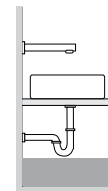

Telescopic and inspectionable bottle-type drain trap for bidet

- 13463440 23,00

Sifone telescopico a bottiglia ispezionabile con calotta per bidet

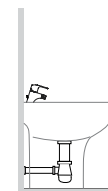

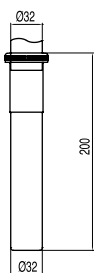

Extender for bottle-type drain trap

Length: 200 mm.

Prolunga per sifone telescopico a bottiglia

Lunghezza: 200 mm.

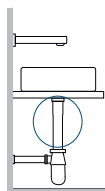

	913463320	15,00
	913463320NM	23,00 N
	913463320BM	23,00 N
	913463320AC	23,00 N
	913463320KM	23,00 N
	913463320KMB	23,00 N
	913463320OR	52,00 N
	913463320OM	52,00 N
	913463320OP	52,00 N
	913463320OPM	52,00 N
	913463320LV	22,00 N
	913463320LM	22,00 N

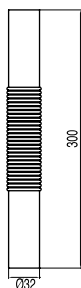

Flexible corrugated pipe for bottle-type drain trap

Length: 300 mm.

Tubo flessibile corrugato per sifone telescopico a bottiglia

Lunghezza: 300 mm.

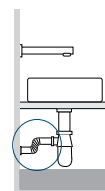

	913463330	12,00
--	-----------	-------

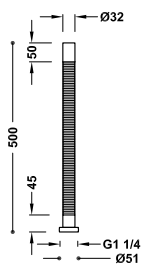

Corrugated flexible drainage pipe

Tubo flessibile corrugato per scarico

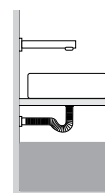

	913463250	18,00
--	-----------	-------

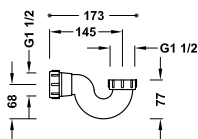

PVC drain trap for bath

Sifone in PVC per vasca

	13463460	5,00
--	----------	------

SHUT-OFF VALVES / VALVOLE DI INTERCETTAZIONE

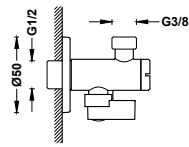

Angle valve with filter
R1/2 - R3/8

Valvola squadrata con filtro
R1/2 - R3/8

- 9134525 16,00
- 9134525NM 25,00

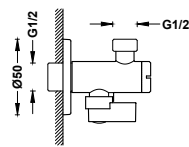
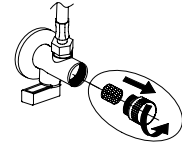

Angle valve with filter
R1/2 - R1/2

Valvola squadrata con filtro
R1/2 - R1/2

- 29952505 16,00

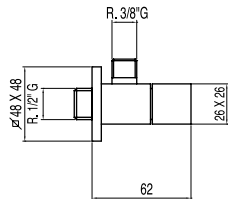
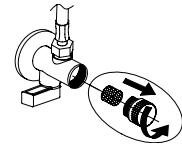

Angle valve

Valvola squadrata

- 13474220 16,00

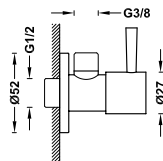

Angle valve

Valvola squadrata

- 13474210 13,00

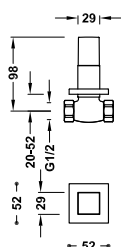

Concealed shut-off valve

Female thread connection: 1/2".

Valvola di intercettazione a incasso

Attacco a filetto femmina: 1/2".

- 00715501 89,00
- 00715501NM 137,00
- 00715501BM 137,00
- 00715501AC 137,00
- 00715501OR 196,00
- 00715501OM 196,00



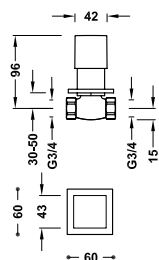

Concealed shut-off valve

Female thread connection: 3/4".

Valvola di intercettazione a incasso

Attacco a filetto femmina: 3/4".

107511

96,00

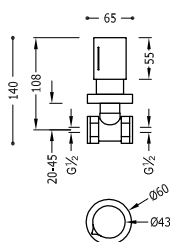

Concealed shut-off valve

Female thread connection: 1/2".

Valvola di intercettazione a incasso

Attacco a filetto femmina: 1/2".

06115501

83,00

06115501NM

128,00

06115501BM

128,00

06115501AC

128,00

06115501KM

128,00

06115501KMB

128,00

06115501OR

182,00

06115501OM

182,00

06115501OP

182,00

06115501OPM

182,00

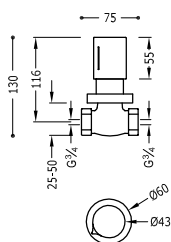

Concealed shut-off valve

Female thread connection: 3/4".

Valvola di intercettazione a incasso

Attacco a filetto femmina: 3/4".

06151101

91,00

06151101NM

140,00

06151101BM

140,00

06151101AC

140,00

06151101KM

140,00

06151101KMB

140,00

06151101OR

199,00

06151101OM

199,00

06151101OP

199,00

06151101OPM

199,00



Extension for shut-off valve

29915501

37,00

Prolunga per valvola di arresto

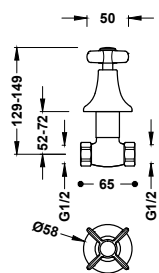

Concealed shut-off valve

With G1/2 threaded connection. Ceramic index (cold).

Valvola di intercettazione a incasso

Con attacco filettato da G1/2. Indicatore in ceramica (freddo).

24215501

93,00

24215501AC

145,00

24215501OR

206,00

24215501LV

136,00

24215501LM

136,00



29910501

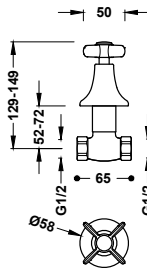

Concealed shut-off valve

With G1/2 threaded connection. Ceramic index (hot).

Valvola di intercettazione a incasso

Con attacco filettato da G1/2. Indicatore in ceramica (caldo).



24215502	93,00
24215502AC	145,00
24215502OR	206,00
24215502LV	136,00
24215502LM	136,00

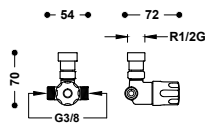

2-outlet mixer valve for timed or electronic taps

Suitable for transporting pre-mixed water to a kitchen or washbasin tap with one water outlet.

Valvola miscelatrice a 2 getti per miscelatore temporizzato o elettronico

Adatto per far passare l'acqua premiscelata a un miscelatore a 1 getto da lavabo e cucina.

29944601	55,00
----------	-------

ELBOW CONNECTIONS / RACCORDI A GOMITO

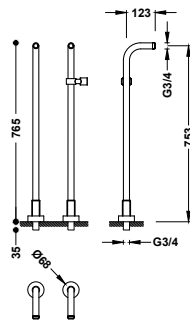

Elbow water connectors for floor installation for bath tap

2 units with fixed support for hand shower.

Prese d'acqua a gomito da terra per miscelatore della vasca

2 unità con supporto fisso per doccia.

161194	310,00
161194NM	481,00
161194AC	481,00
161194OM	682,00
161194OPM	682,00

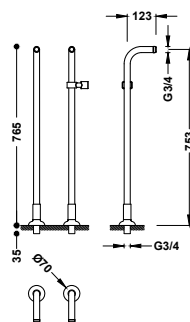

Elbow water connectors for floor installation for bath tap

2 floor-mounted vertical water supply columns.

Prese d'acqua a gomito da terra per miscelatore della vasca

2 colonne verticali di alimentazione dell'acqua a terra.

24219403	350,00
24219403AC	543,00
24219403OM	770,00
24219403LV	508,00
24219403LM	508,00

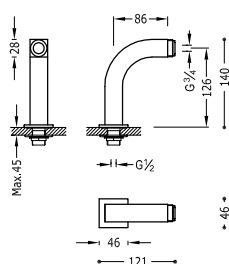

Elbow water connectors for installation on bath edge for bath tap

2 units with silencer.

Prese d'acqua a gomito bordo vasca per miscelatore della vasca

2 unità con silenziatore.

29987002	126,00
----------	--------



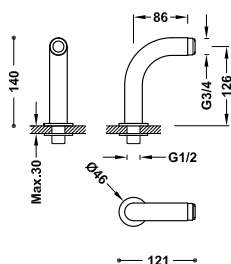

Elbow water connectors for installation on bath edge for bath tap

2 units with silencer.

Prese d'acqua a gomito bordo vasca per miscelatore della vasca

2 unità con silenziatore.

■ 29987001	114,00
■ 29987001NM	177,00
■ 29987001AC	177,00
■ 29987001OM	251,00
■ 29987001OPM	251,00

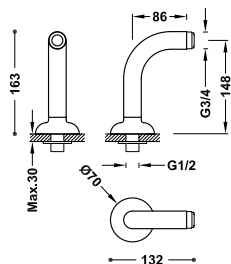

Elbow water connectors for installation on bath edge for bath tap

2 units with silencer.

Prese d'acqua a gomito bordo vasca per miscelatore della vasca

2 unità con silenziatore.

■ 24287101	154,00
■ 24287101AC	239,00
■ 24287101OR	339,00
■ 24287101LV	223,00
■ 24287101LM	223,00

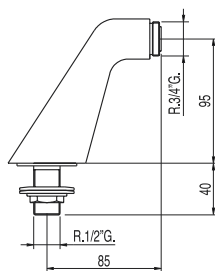

Elbow water connectors for installation on bath edge for bath tap

2 units with silencer.

Prese d'acqua a gomito bordo vasca per miscelatore della vasca

2 unità con silenziatore.

■ 134871	102,00
----------	--------

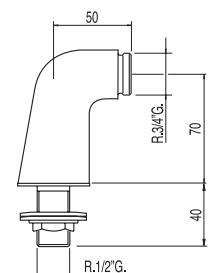

Elbow water connectors for installation on bath edge for bath tap

2 units with silencer.

Prese d'acqua a gomito bordo vasca per miscelatore della vasca

2 unità con silenziatore.

■ 134870	89,00
----------	-------

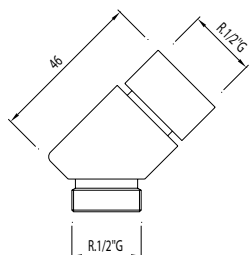

Universal elbow connector for hand shower

Suitable for shower baths. For ref.: 14150, 61150, 62150, 63145, 61161, 87150, 87161, 89150, 89161.

Raccordo a gomito universale per doccia

Adatto per vasca da appoggio. Per rif.: 14150, 61150, 62150, 63145, 61161, 87150, 87161, 89150, 89161.

■ 913414580	43,00
-------------	-------

SPOUTS / CANNE

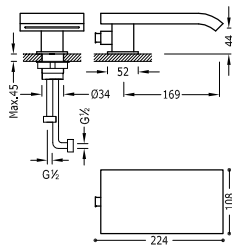

Fixed spout for bath edge with cascade outlet

18718250

368,00

Closed spout with cascade outlet. Inverter integrated into the spout.

Canna fissa per bordo vasca con getto a cascata

Canna chiusa con getto a cascata. Inverter incorporato nella canna.

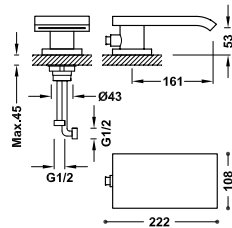

Fixed spout for bath edge with cascade outlet

16216150

315,00

Closed spout with cascade outlet. Inverter integrated into the spout.

Canna fissa per bordo vasca con getto a cascata

Canna chiusa con getto a cascata. Inverter incorporato nella canna.

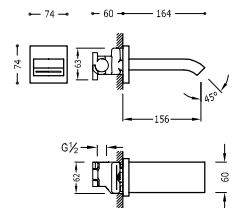

Fixed wall-mounted spout with cascade outlet

107181

200,00

Closed spout with cascade outlet. With depth-adjustable wall water supply. Concealed body included.

Canna fissa a muro con getto a cascata

Canna chiusa con getto a cascata. Con presa d'acqua a muro regolabile in profondità. Corpo a incasso incluso.

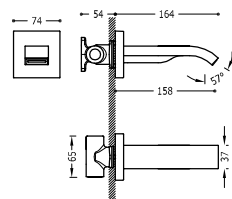

Fixed wall-mounted spout with cascade outlet

20718107

160,00

Closed spout with cascade outlet. With depth-adjustable wall water supply. Concealed body included.

Canna fissa a muro con getto a cascata

Canna chiusa con getto a cascata. Con presa d'acqua a muro regolabile in profondità. Corpo a incasso incluso.

20718107NM

248,00

20718107BM

248,00

20718107AC

248,00

20718107OR

352,00

20718107OM

352,00

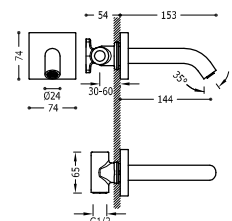

Fixed wall-mounted spout

With depth-adjustable wall water supply. Concealed body included.

Canna fissa a muro

Con presa d'acqua a muro regolabile in profondità. Corpo a incasso incluso.

21018107

102,00

21018107NM

158,00

21018107BM

158,00

21018107AC

158,00

21018107KM

158,00

21018107KMB

158,00

21018107OR

224,00

21018107OM

224,00

21018107OP

224,00

21018107OPM

224,00



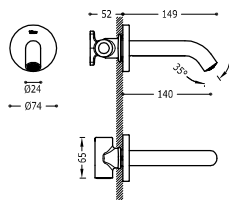

Fixed wall-mounted spout

With depth-adjustable wall water supply. Concealed body included.

Canna fissa a muro

Con presa d'acqua a muro regolabile in profondità. Corpo a incasso incluso.

26218004	102,00
26218004NM	158,00
26218004BM	158,00
26218004AC	158,00
26218004KM	158,00
26218004KMB	158,00
26218004OR	224,00
26218004OM	224,00
26218004OP	224,00
26218004OPM	224,00

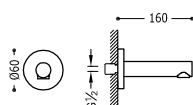

Fixed wall-mounted spout

With G1/2" threaded water supply. Length: 160 mm. Not a spare part. Not compatible with indivisible concealed bodies.

Canna fissa a muro

Con presa d'acqua filettata G1/2. Lunghezza: 160 mm. Non è un ricambio. Non è compatibile con set a incasso indivisibili.

16117002	102,00
----------	--------

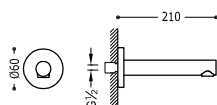

Fixed wall-mounted spout

With G1/2" threaded water supply. Length: 210 mm. Not a spare part. Not compatible with indivisible concealed bodies.

Canna fissa a muro

Con presa d'acqua filettata G1/2. Lunghezza: 210 mm. Non è un ricambio. Non è compatibile con set a incasso indivisibili.

06117202	108,00
----------	--------

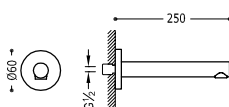

Fixed wall-mounted spout

With G1/2" threaded water supply. Length: 250 mm. Not a spare part. Not compatible with indivisible concealed bodies.

Canna fissa a muro

Con presa d'acqua filettata G1/2. Lunghezza: 250 mm. Non è un ricambio. Non è compatibile con set a incasso indivisibili.

16117102	116,00
----------	--------

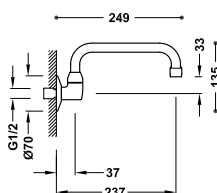

Wall-mounted swivel spout

Pipe-style. Length: 237 mm.

Canna girevole a muro

Tipo tubo. Lunghezza: 237 mm.

134302	55,00
--------	-------



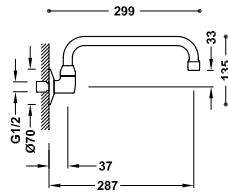

Wall-mounted swivel spout

Pipe-style. Length: 287 mm.

Canna girevole a muro

Tipo tubo. Lunghezza: 287 mm.



134303

59,00

ESCUTCHEONS / ROSONI

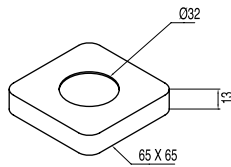

Square escutcheon plate

Material: Brass.

Rosone quadrato

Materiale: Ottone.

913474410

6,00

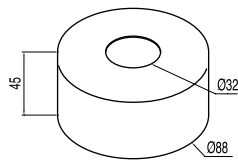

Round escutcheon plate

Material: Brass.

Rosone rotondo

Materiale: Ottone.

913474430

9,00

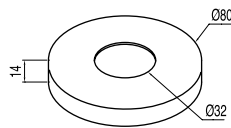

Round escutcheon plate

Material: Brass.

Rosone rotondo

Materiale: Ottone.

913474420

6,00

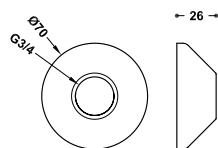

Escutcheon for special offset

Material: Brass. Ø 70 mm.

Rosoni per eccentrici speciali

Materiale: Ottone. Ø 70 mm.

9134781

6,00



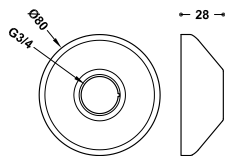

Escutcheon for special offset

Material: Brass. Ø 80 mm.

Rosoni per eccentrici speciali

Material: Ottone. Ø 80 mm.

9134784

8,00

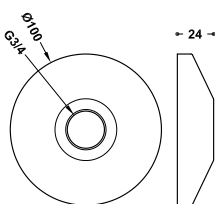

Escutcheon for special offset

Material: Brass. Ø 100 mm.

Rosoni per eccentrici speciali

Material: Ottone. Ø 100 mm.

9134788

12,00

OFFSETS / ECCENTRICI



Offset with silencer to divert tapware outlet

Male threaded connection: 1/2". Offset: 7,5 mm. 13,5 - 16,5 mm.

Eccentrico con silenziatore per spostare la presa del miscelatore

Attacco filettato maschio: 1/2". Spostamento: 7,5 mm. 13,5 - 16,5 mm.

9134779

10,00

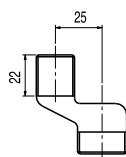

Offset with silencer to divert tapware outlet

Male threaded connection: 1/2". Offset: 25 mm. 10 - 20 mm.

Eccentrico con silenziatore per spostare la presa del miscelatore

Attacco filettato maschio: 1/2". Spostamento: 25 mm. 10 - 20 mm.

9134780

14,00

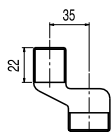

Offset to divert tapware outlet

Male threaded connection: 1/2". Offset: 35 mm. 8 - 22 mm.

Compatible with the rosette ref: 9134788

Eccentrico per spostare la presa del miscelatore

Attacco filettato maschio: 1/2". Spostamento: 35 mm. 8 - 22 mm.

Compatibile con il fiore rif: 9134788

9134787

13,00

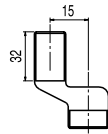

Offset with silencer to divert tapware outlet

9134786

12,00

Male threaded connection: 1/2". Offset: 15 mm. 12 -18 mm.

Eccentrico con silenziatore per spostare la presa del miscelatore

Attacco filettato maschio: 1/2". Spostamento: 15 mm. 12 -18 mm.

THERMOSTATIC VALVE / VALVOLA TERMOSTATICA

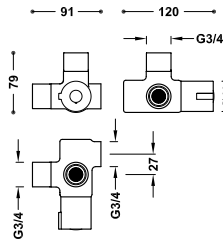

Thermostatic valve for the boiler

20725001

160,00

- Filters in the water inlets.
- With non-return valves in the water inlets.
- Ideal for public places where a constant temperature is desired.

Valvola termostatica per lo scaldabagno

- Filtri all'ingresso dell'acqua.
- Con valvole di ritegno all'ingresso dell'acqua.
- Ideale per gli spazi pubblici dove è richiesta una temperatura costante.

- Brass body. / *Corpo in ottone.*
- Reduces energy and water consumption in recirculation circuits. / *Riduce il consumo di energia e di acqua nella rete di ricircolo.*
- Increases the volume of hot water by adding cold water at the boiler outlet. / *Aumenta il volume di acqua calda poiché viene aggiunta l'acqua fredda all'uscita dello scaldabagno.*
- Safety: prevents hot water burns. / *Sicurezza: evita ustioni causate dall'acqua calda.*

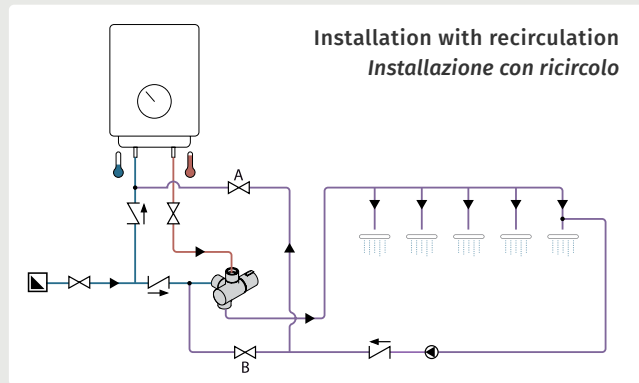
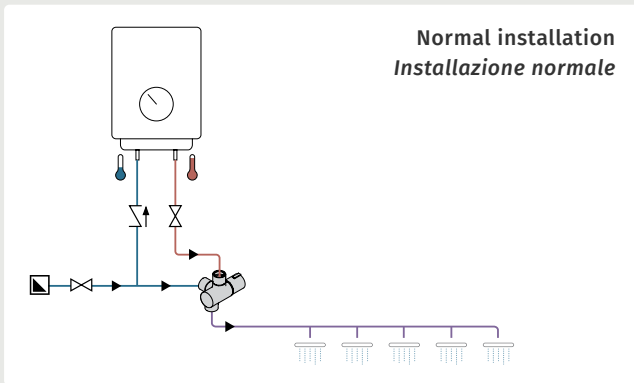



WC SYSTEMS

Tres offers water cistern mechanisms as an affordable and quality alternative for your bathroom. Different mechanisms for filling and flushing, with a similar mode of operation and installation but with particular characteristics to meet the different needs of each type of cistern.

Tres propone meccanismi per cassette w.c. come alternativa economica e di qualità per questi elementi presenti in un bagno. Esistono diversi modelli sia per il riempimento che per lo svuotamento con un funzionamento e una installazione simili ma con caratteristiche particolari per risolvere le diverse esigenze di qualsiasi tipo di cassetta.



FILLING MECHANISMS / MECCANISMO DI RIEMPIMENTO

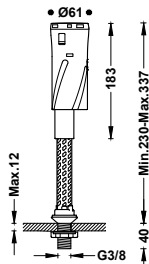

Filling mechanism for toilet cistern

25477001

13,00

- Lower filling monoblock.
- G3/8 water inlet with brass coupling.
- With quick and easy water level adjustment.
- With easy-access filter.
- Extra silent. Just 16 db.
- Fast-filling: 5.2 l. (5 bars)
- Superior regulation.

Meccanismo di riempimento per cassetta del WC

- Monoblocco di riempimento inferiore.
- Ingresso dell'acqua G3/8 con raccordo in ottone.
- Con regolazione facile e veloce del livello di acqua.
- Con filtro di facile accesso.
- Ultra silenzioso. Soltanto 16 db.
- Riempimento veloce: 5,2 l. (5 bar)
- Regolazione superiore.

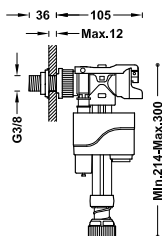

Filling mechanism for toilet cistern

25477007

14,00

- Bottom or side-filling.
- Side or lower water inlet by swapping the brass coupling.
- G3/8 water inlet with brass coupling.
- Filter in the water inlet.
- With quick and easy water level adjustment.
- Superior regulation.

Meccanismo di riempimento per cassetta del WC

- Riempimento inferiore o laterale.
- Ingresso dell'acqua laterale o inferiore scambiando il raccordo in ottone.
- Ingresso dell'acqua G3/8 raccordo in ottone.
- Filtro all'ingresso dell'acqua.
- Con regolazione facile e veloce del livello di acqua.
- Regolazione superiore.

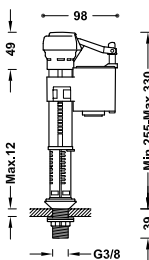

Filling mechanism for toilet cistern

25477002

12,00

- Lower-filling.
- G3/8 water inlet with brass coupling.
- Filter in the water inlet.
- Easy water level adjustment.
- Superior regulation.

Meccanismo di riempimento per cassetta del WC

- Riempimento inferiore.
- Ingresso dell'acqua G3/8 con raccordo in ottone.
- Filtro all'ingresso dell'acqua.
- Con regolazione del livello di acqua.
- Regolazione superiore.

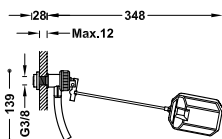

Filling mechanism for toilet cistern

25477004

9,00

- Side-filling.
- Buoy attached with brass rod.
- G3/8 water inlet with brass coupling.
- Filter in the water inlet.

Meccanismo di riempimento per cassetta del WC

- Riempimento laterale.
- Attacco della sfera con asta in ottone.
- Ingresso dell'acqua G3/8 raccordo in ottone.
- Filtro all'ingresso dell'acqua.

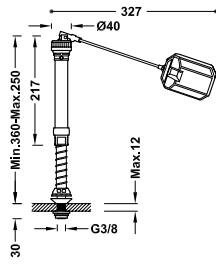

Filling mechanism for toilet cistern

25477003

10,00

- Lower-filling.
- Buoy attached with brass rod.
- G3/8 water inlet with brass coupling.
- Filter in the water inlet.
- Easy water level adjustment.

Meccanismo di riempimento per cassetta del WC

- Riempimento inferiore.
- Attacco della sfera con asta in ottone.
- Ingresso dell'acqua G3/8 raccordo in ottone.
- Filtro all'ingresso dell'acqua.
- Con regolazione del livello di acqua.

FLUSH MECHANISMS / MECCANISMO DI SCARICO

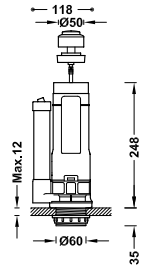

Flush mechanism for toilet cistern

25477012

13,00

- Single flush.
- Top operation.
- Universal mechanism with push button.
- Single flush button.
- Overflow height adjustment.
- Flush adjustment range.
- With silicone seal.

Meccanismo di scarico per cassetta del WC

- Scarico unico.
- Azionamento superiore.
- Meccanismo universale con pulsante.
- Pulsante di scarico unico.
- Regolazione dell'altezza del troppopieno.
- Intervallo di regolazione per lo scarico.
- Con guarnizione in silicone.

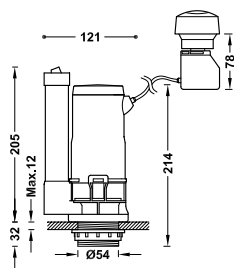

Flush mechanism for toilet cistern

25477009

16,00

- Double flush.
- Top or side operation
- Universal mechanism with double push button.
- Full flush button and partial flush button.
- Overflow height adjustment.
- With silicone seal.

Meccanismo di scarico per cassetta del WC

- Doppio scarico.
- Azionamento superiore o laterale
- Meccanismo universale con doppio pulsante.
- Pulsante di scarico completo e pulsante di scarico parziale.
- Regolazione dell'altezza del troppopieno.
- Con guarnizione in silicone.

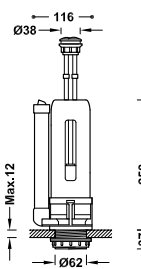

Flush mechanism for toilet cistern

25477005

14,00

- Double flush.
- Top operation.
- Universal mechanism with double push button.
- Full flush button and partial flush button.
- Rapid flush.
- With silicone seal.

Meccanismo di scarico per cassetta del WC

- Doppio scarico.
- Azionamento superiore.
- Meccanismo universale con doppio pulsante.
- Pulsante di scarico completo e pulsante di scarico parziale.
- Velocità di scarico rapida.
- Con guarnizione in silicone.



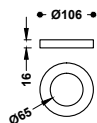

Connection seal

Material: Foam. Dimensions: 106x65x16 mm.

Guarnizione di tenuta

Materiale: Foam. Dimensioni: 106x65x16 mm.

25477006

3,00

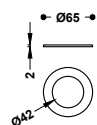

Silicone seal

Dimensions: 65x42x2 mm.

Guarnizione in silicone

Dimensioni: 65x42x2 mm.

25477010

3,00



Screws for attaching cistern to toilet

Viti di fissaggio della cassetta al WC

25477008

5,00

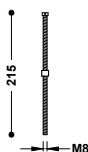

Threaded bar

2 units

Barra filettata

2 unità

25477011

4,00

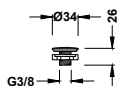

Plug for cistern

Tappo per cassetta

25477013

4,00



Complete filling mechanism set for toilet cistern

25477091

39,00

- 25477001 - Filling mechanisms
- 25477009 - Flushing mechanisms
- 25477006 - Connection seal
- 25477008 - Cistern attaching screws
- 25477013 - Cistern plug

Set completo di meccanismo di riempimento per cassetta del WC

- 25477001 - Meccanismi di riempimento
- 25477009 - Meccanismi di scarico
- 25477006 - Guarnizione di tenuta
- 25477008 - Viti di attacco per cassetta wc
- 25477013 - Tappo per cassetta wc



Complete filling mechanism set for toilet cistern

25477092

40,00

- 25477007 - Filling mechanisms
- 25477009 - Flushing mechanisms
- 25477006 - Connection seal
- 25477008 - Cistern attaching screws
- 25477013 - Cistern plug

Set completo di meccanismo di riempimento per cassetta del WC

- 25477007 - Meccanismi di riempimento
- 25477009 - Meccanismi di scarico
- 25477006 - Guarnizione di tenuta
- 25477008 - Viti di attacco per cassetta wc
- 25477013 - Tappo per cassetta wc





TRES CLEANER

Tres Cleaner is a cleaning spray for bathroom and kitchen taps tested for Tres products. Double action to remove dirtiness and maintain the finish of the tapware. To use the cleaner, just spray, leave to act briefly, rinse with warm water and dry with a soft cloth.

Tres Cleaner è un detergente spray per rubinetti da bagno e cucina testato per i prodotti Tres. Doppia funzione per rimuovere lo sporco e conservare la finitura del rubinetto. Spruzzare il detergente sull'area da pulire, lasciare brevemente in posa, sciacquare con acqua calda e asciugare con un panno morbido.



TRES CLEANER

The best product for cleaning metallic and shiny tap surfaces

Il più raccomandato per la pulizia di rubinetti in metallo e lucidi



Polishes surfaces
Lucida le superfici



Removes fingerprints
Elimina le tracce



Repels dirt
Gets rid of limescale
*Rimuove lo sporco
Elimina il calcare*



Prevents static
Previene l'attrito statico



With the nozzle open, the liquid disperses in a fine spray which reaches wider areas like screen doors and mirrors.
Con l'ugello aperto, il liquido si diffonde grazie allo spruzzo fino a raggiungere aree più grandi, come cabine doccia e specchi.



With the nozzle closed, the cleaning foam adheres and acts significantly more efficiently on dirt for a deeper clean.
Con l'ugello chiuso, la schiuma detergente attiva aderisce e agisce più a fondo sullo sporco assicurando una pulizia intensa e completa.



TAPWARE CLEANER / DETERGENTE PER RUBINETTI



Tres Cleaner. Tapware cleaner for kitchen and bathroom

134100106

16,00

- Shines surfaces.
- Removes finger marks.
- Repels dirt.
- Removes limescale.
- Anti-static effect.
- 750 ml.

Tres Cleaner. Detergente per rubinetti da bagno e cucina

- Lucida le superfici.
- Elimina le tracce.
- Rimuove lo sporco.
- Elimina il calcare.
- Effetto antistatico.
- 750 ml.



Box with 12 units. Tres Cleaner. Tapware cleaner for kitchen and bathroom

134100106CB12

173,00

- Shines surfaces.
- Removes finger marks.
- Repels dirt.
- Removes limescale.
- Anti-static effect.
- 750 ml.

Scatola da 12 unità. Tres Cleaner. Detergente per rubinetti da bagno e cucina

- Lucida le superfici.
- Elimina le tracce.
- Rimuove lo sporco.
- Elimina il calcare.
- Effetto antistatico.
- 750 ml.



Complete shower head and tap maintenance and cleaning set

134100108

32,00

Tres Cleaner 750 ml. + Telescopic handle for cleaning.

Set completo per la manutenzione e la pulizia di soffioni e miscelatori

Tres Cleaner 750 ml. + Manico telescopico per pulizia.



Box with 16 units. Complete shower head and tap maintenance and cleaning set

13410010816

486,00

Tres Cleaner 750 ml. + Telescopic handle for cleaning.

Scatola da 16 unità. Set completo per la manutenzione e la pulizia di soffioni e miscelatori

Tres Cleaner 750 ml. + Manico telescopico per pulizia.



ANNEX ALLEGATO

516 Recommended installation
Installazione consigliata

518 Spare parts
Ricambi

522 Product list
Elenco dei riferimenti

534 Terms of sale
Condizioni di vendita



RECOMMENDED INSTALLATION INSTALLAZIONE CONSIGLIATA

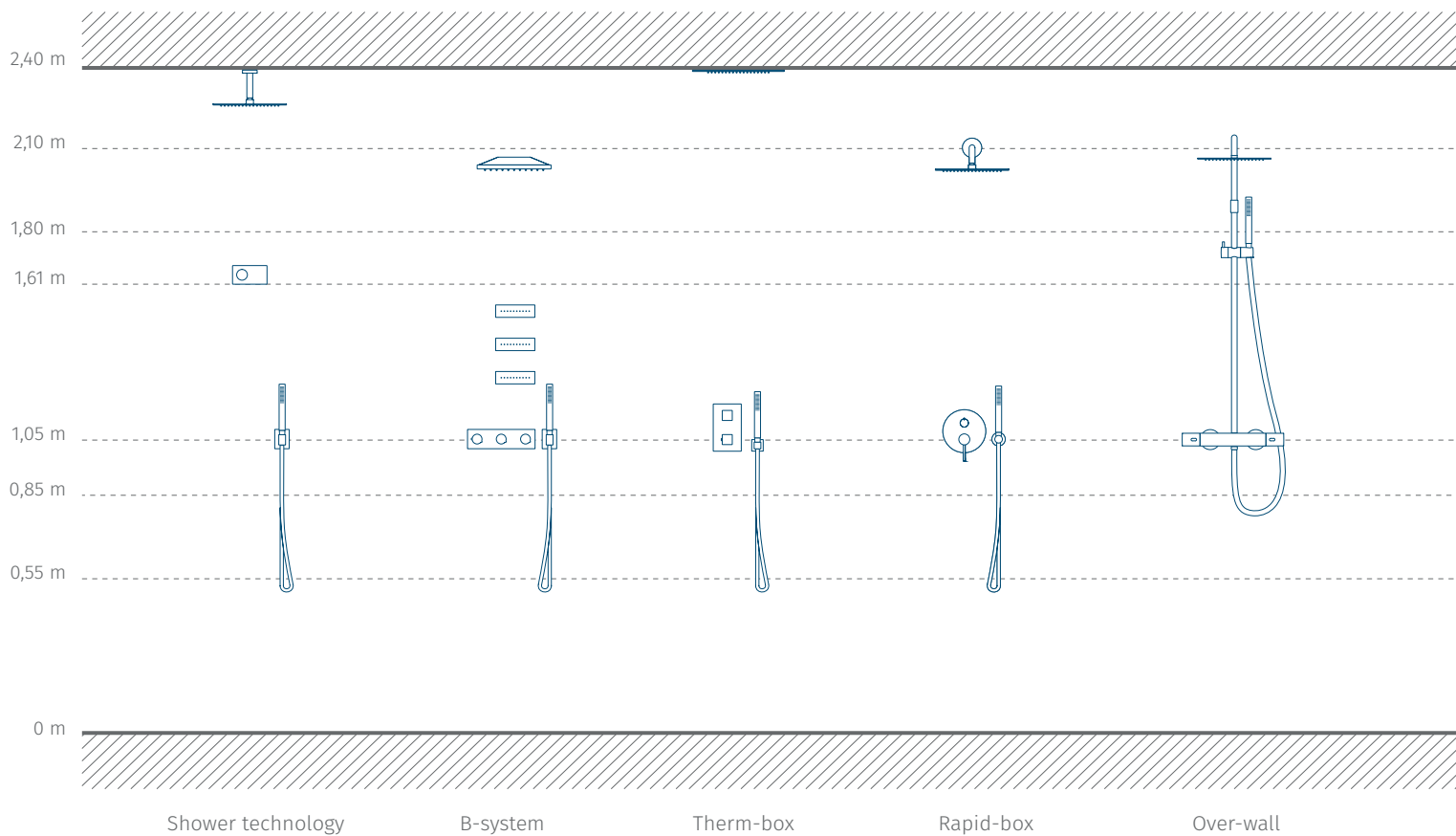



Shower or bath drains

You can use taps with two water outlets at the same time, provided that the drain is designed to accommodate this.

Scarichi di doccia o vasca da bagno

I rubinetti con 2 uscite d'acqua possono essere utilizzati contemporaneamente a condizione che lo scarico sia progettato per questo scopo.

Water supply







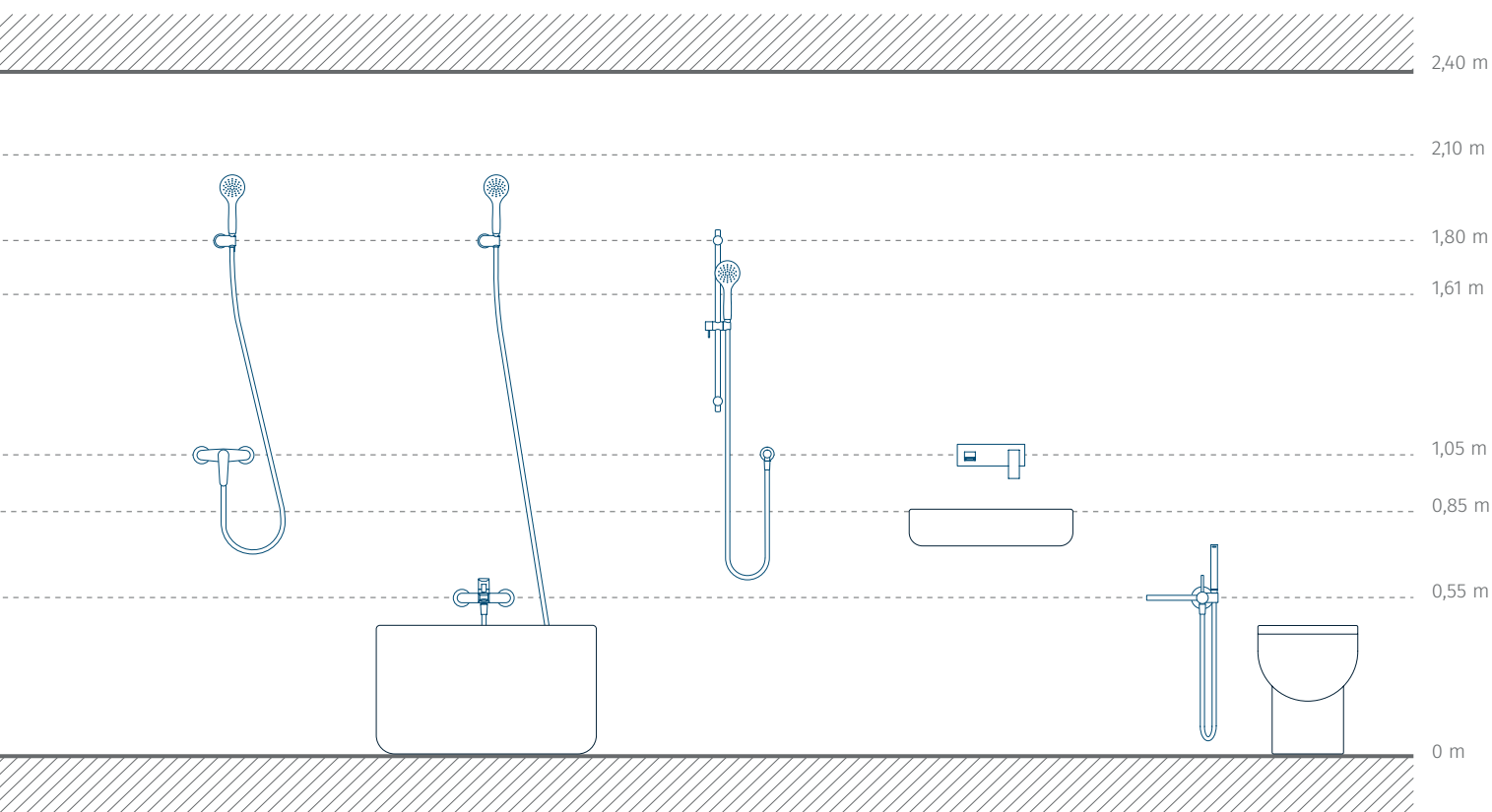











































The water flow for each product may require different pressure levels, but a dynamic pressure of 2 to 3 should be sufficient. The dynamic pressure is measured with the tap turned on.

































Erogazione dell'acqua

La portata di ogni prodotto può richiedere pressioni diverse, ma una pressione dinamica di 2 o 3 bar sarebbe sufficiente. La pressione dinamica è misurata con il rubinetto aperto.



















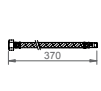



























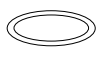

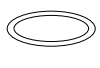



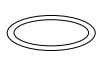



Visit our website to find more spare parts and detail drawings of the tapware
 Per altri ricambi o esplosi della rubinetteria, visita la nostra pagina web

	SLC Cascade Aerator. 24 Male. Aeratore Cascade SLC. Maschio 24	 9134673  9134673503  9134673501	6,00 13,00 13,00
	Aerator 18 Male Aeratore Maschio 18	9262503	7,00
	SLC Cascade Aerator. 22 Female. Aeratore Cascade SLC. Femmina 22	 9134672  9134672501	6,00 13,00
	Aerator 24 Male; C-type locking ring Aeratore Maschio 24; ritegno "C"	 29966310	5,00
	Aerator 28 Male Aeratore Maschio 28	9134674	6,00
	Rectangular concealed aerator + key Aeratore a scomparsa + Chiave	9106006	9,00
	Flush aerator. 24 Male. Aeratore a scomparsa. Maschio 24	29961001	5,00
	Flush aerator. 16 Male. Water flow: 8 l/min. Aeratore a scomparsa. Maschio 16. Flusso: 8 l/m.	29961002	6,00
	Aerator. 16 Male. Water flow: 5 l/min. Aeratore Maschio 16 Portata: 5 l/m.	29961005	6,00
	Concealed aerator 16,5 Male + key Aeratore a scomparsa 16,5 Maschio e chiave	9134665	7,00
	Concealed aerator 16,5 Male + key Aeratore a scomparsa 16,5 Maschio e chiave	9134666	7,00
	Concealed aerator 24 Male + key Rompigetto a scomparsa. Maschio 24 + Chiave	9134668	6,00
	Flush and adjustable breakwater. 24 Male. + key Rompigetto a scomparsa e orientabile. Maschio 24 + Chiave	29961006	7,00
	Ball-and-socket joint bidet mixer 16,5 + key Rotula 16,5 + Chiave	 9107672	14,00
	Ball-and socket joint 22 + Aerator Rotula 22 + Aeratore	 9134577	7,00
	Ball-and socket joint 24 + Aerator Rotula 24 + Aeratore	 9134677	7,00
	Flow limiter. 24 Male. Water flow: 6 l/min. Limitatore del flusso. Maschio 24. Flusso: 6 l/m.	 91346826	6,00
	Flow limiter. 24 Male. Water flow: 8 l/min. Limitatore del flusso. Maschio 24. Flusso: 8 l/m.	 9134682	9,00
	Flow limiter. 24 Male. Water flow: 5 l/min. Limitatore del flusso. Maschio 24. Flusso: 5 l/m.	 91346825	8,00
	Aerator + Housing. 24 Male. Water flow: 5 l/min. Aeratore + Alloggiamento. Maschio 24. Flusso: 5 l/m.	 23461305	8,00
	Flow limiter. 22 Female. Water flow: 6 l/min. Limitatore del flusso. Femmina 22. Flusso: 6 l/m.	 91346816	6,00
	Flow limiter. 22 Female. Water flow: 8 l/min. Limitatore del flusso. Femmina 22. Flusso: 8 l/m.	 9134681	8,00
	Flow limiter. 22 Female. Water flow: 5 l/min. Limitatore del flusso. Femmina 22. Flusso: 5 l/m.	 91346815	8,00
	Aerator. 22 Female + Housing. Water flow: 4,5 l/min. Aeratore Femmina 22 + Alloggiamento. Flusso: 4,5 l/m.	 23466205	6,00
	Flush aerator. 24 Male. Water flow: 4,5 l/min. Aeratore a scomparsa. Maschio 24. Flusso: 4,5 l/m.	23461015	6,00
	Flush aerator. 24 Male. Water flow: 3,8 l/min. Aeratore a scomparsa. Maschio 24. Flusso: 3,8 l/m.	23461013	6,00
	Concealed aerator 24 Male + Housing. Water flow: 1,9 l/min. Rompigetto a scomparsa. Maschio 24 + Alloggiamento. Flusso: 1,9 l/m.	23466001	6,00
	Flush aerator. 16,5 Male. Water flow: 4,5 l/min. Aeratore a scomparsa. Maschio 16,5. Flusso: 4,5 l/m.	23461050	6,00
	Flush aerator. 24 Male. Water flow: 4,5 l/min. Aeratore a scomparsa. Maschio 24. Flusso: 4,5 l/m.	23444005	7,00
	Flush aerator. 24 Male. Water flow: 3,8 l/min. Aeratore a scomparsa. Maschio 24. Flusso: 3,8 l/m.	23461303	6,00
	Flush aerator. 24 Male. Water flow: 1,9 l/min. Aeratore a scomparsa. Maschio 24. Flusso: 1,9 l/m.	23461301	6,00
	Aerator. 22 Female + Housing. Water flow: 3,8 l/min. Aeratore Femmina 22 + Alloggiamento. Flusso: 3,8 l/m.	 23466203	6,00
	Flush aerator. 16,5 Male. Water flow: 4,5 l/min. Aeratore a scomparsa. Maschio 16,5. Flusso: 4,5 l/m.	23461501	6,00

	Flush aerator. 16,5 Male. Water flow: 3,8 l/min. Aeratore a scomparsa. Maschio 16,5. Flusso: 3,8 l/m.	23461380	6,00		Pull-out shower for kitchen tap. 2 stream types. R1/2" Doccino estraibile per miscelatore cucina. 2 tipi di getto. R1/2"	9134849	31,00
	Aerator without Housing. 17. Water flow: 4,5 l/min. Aeratore senza alloggiamento 17. Flusso: 4,5 l/m.	23466905	6,00		Pull-out shower for kitchen tap. 2 stream types. R1/2" Doccino estraibile per miscelatore cucina. 2 tipi di getto. R1/2"	913043810	36,00
	Aerator without Housing. 17. Water flow: 3,8 l/min. Aeratore senza alloggiamento 17. Flusso: 3,8 l/m.	23466938	6,00		Shower for kitchen tap R1/2" Doccia per miscelatore cucina. R1/2"	9134481	70,00
	Aerator without Housing. 21. Water flow: 4,5 l/min. Aeratore senza alloggiamento 21. Flusso: 4,5 l/m.	23467205	6,00		Shower for kitchen tap. 2 stream types. R1/2" Doccia per miscelatore cucina. 2 tipi di getto. R1/2"	913049310	35,00
	Aerator without Housing. 21. Water flow: 3,8 l/min. Aeratore senza alloggiamento 21. Flusso: 3,8 l/m.	23467238	6,00		Piston Pistone	9133317	7,00
	Flush aerator. 18,5 Male. Water flow: 3,8 l/min. Aeratore a scomparsa. Maschio 18,5. Flusso: 3,8 l/m.	23461038	6,00		Free outlet cartridge Mono-term Ø 40 mm. Cartuccia Mono-term Ø 40 mm.	29919505	60,00
	Flow regulator for hose. 1/2" Male-female. Water flow: 8 l/min. Limitatore di flusso per flessibile. 1/2" Maschio-femmina. Flusso: 8 l/m.	9134683	11,00		Free outlet cartridge Ø 25 mm. + Limiter 5,5 l/min. Cartuccia Ø 25 mm. + Limitatore 5,5 l/m.	29919001	43,00
	Flow regulator for hose. 1/2" Male-female. Water flow: 7,5 l/min. Limitatore di flusso per flessibile. 1/2" Maschio-femmina. Flusso: 7,5 l/m.	23468301	9,00		Free outlet cartridge Ø 25 mm. Cartuccia Ø 25 mm.	9130190	40,00
	Flow regulator for hose. 1/2" Male-female. Water flow: 6 l/min. Limitatore di flusso per flessibile. 1/2" Maschio-femmina. Flusso: 6 l/m.	23468303	9,00		Free outlet cartridge Ø 25 mm. Cartuccia Ø 25 mm.	910719005	40,00
	Fixed spout for bath edge Canna fissa per bordo vasca	913214591	120,00		Fixed outlet cartridge Ø 35 mm. Cartuccia Ø 35 mm.	9134591	40,00
	Spout Ø 28 mm. Tubo lavello Ø 28 mm.	9174441	30,00		Free outlet cartridge Ø 35 mm. Cartuccia Ø 35 mm.	9134592	40,00
	Tube spout 15 cm. R3/4" Canna tubo 15 cm. R3/4"	9134314	20,00		Fixed outlet cartridge Ø 40 mm. Cartuccia Ø 40 mm.	9134288	40,00
	Tube spout 20 cm. R3/4" Canna tubo 20 cm. R3/4"	9134315	25,00		Free outlet cartridge Ø 40 mm. Cartuccia Ø 40 mm.	9134290	40,00
	Tube spout 25 cm. R3/4" Canna tubo 25 cm. R3/4"	9134316	30,00		Cartridge distributor 2 outlets thermostatic tap. Ø 35 mm. Cartuccia distributore Ø 35 mm.	9134235	46,00
	Tube spout 30 cm. R3/4" Canna tubo 30 cm. R3/4"	9134319	35,00		Cartridge distributor 2 outlets built-in tap. Ø 35 mm. Cartuccia distributore termostatico Ø 35 mm.	9194283	46,00
	Kitchen faucet tube spout R3/4" Canna tubo R3/4"	9134441	30,00		Thermostatic cartridge with flow regulator - Compact Cartuccia con regolatore di portata - Compact	9194552	120,00
	Pull-out shower for kitchen tap. 2 stream types. R1/2" Doccino estraibile per miscelatore cucina. 2 tipi di getto. R1/2"	9134880	28,00		Instant 57 thermostatic cartridge Cartuccia termostatica Instant 57	29916901	59,00



	Instant 77 thermostatic cartridge Cartuccia termostatica Instant 77	29916902	66,00		Valve stem (cold) Right Vitone fredda	913427220	15,00
	Diverter 2 outlets for tap Invertitore automatico 180	916218005	31,00		Valve stem (hot) Left Vitone calda	913427210	15,00
	Diverter 2 outlets for tap Invertitore automatico 180	29955304	31,00		Flexible connection Male 8x1 - R3/8" L. 600 mm. Tubo flessibile Maschio 8x1 - 3/8" Lungo. 600 mm.	29908405	11,00
	Diverter 2 outlets for tap Invertitore automatico 180	910618020	31,00		Flexible connection Male 8x1 - R3/8" L. 450 mm. Tubo flessibile Maschio 8x1 - 3/8" Lungo. 450 mm.	29908406	10,00
	Diverter 2 outlets for Mono-term tap Invertitore automatico Mono-term	29955303	31,00		Flexible connection Male 9x1 L. 370 mm. Tubo flessibile Maschio 9x1 Lungo. 370 mm.	9134803	9,00
	Diverter for wall-mounted bath tap Invertitore automatico	9134256	14,00		Flexible connection Male 10x1 - R3/8" L. 370 mm. Tubo flessibile Maschio 10x1 - 3/8" Lungo. 370 mm.	9134806	8,00
	Diverter for wall-mounted bath tap Invertitore automatico	9134250	13,00		Button and rod set Set asta e pulsante	913484007	9,00
	Diverter for wall-mounted bath tap - Essential Invertitore automatico - Essential	29955306	13,00		Pup-up waste + Rod Scarico automatico + Asta	913484057	25,00
	Valve Stem R1/2" Vitone 1/2"	9134286	8,00		Pup-up waste + Rod Scarico automatico + Asta	913427510	25,00
	Valve Stem R1/2" Vitone 1/2"	9134296	17,00		Plug for automatic drainage valve. Plug: Ø 63 mm. Tappo per valvola di scarico automatico. Tappo: Ø 63 mm.	913484026	16,00
	Valve Stem R1/2" Vitone 1/2"	9134284	8,00		Pop-up waste plug Tappo scarico automatico	913484016	11,00
	Valve Stem R1/2" Vitone 1/2"	9134294	12,00		Rods joint pop-up waste Giunto stecca scarico automatico	913484005	4,00
	Valve Stem R1/2" Vitone 1/2"	9134282	15,00		Horizontal long rod pop-up waste Tondino lungo orizzontale scarico automatico	9134840061	9,00
	Valve Stem R1/2" Short shaft Vitone ceramica 1/2"	9134292	15,00		Locking base for kitchen tap Base supporto lavello	963033331	4,00
	Valve Stem R1/2" Long shaft Vitone ceramica 1/2"	9134293	15,00		Locking set 6x1 Male L. 120 mm. Set fissaggio 6x1 Maschio Lungo. 120 mm.	919260634	11,00
	Valve Stem R3/8" Vitone 3/8"	9134283	7,00		Locking set 8x1 Male L. 110 mm. Set fissaggio 8x1 Maschio Lungo. 110 mm.	966110301	9,00
	Valve Stem 16 Male Vitone Maschio 16	9162292	15,00		Locking set 8x1 Male L. 250 mm. Set fissaggio 8x1 Maschio Lungo. 250 mm.	916184010	20,00

	Locking set 8x1 Male L. 70 mm. Set fissaggio 8x1 Maschio Lungo. 70 mm.	913010334	7,00		Key + Mono-term cartridge insert Chiave + inserto cartuccia Mono-term	29989601	19,00
	Fixing screw between cast spout and pipe spout. 6x1 Male. Vite di fissaggio. 6x1 Maschio	9133317031	4,00		Sleeve for tube spout Chiave	29919607	3,00
	Fixing screw between cast spout and pipe spout. 6x1 Male. (10 pcs.) Vite di fissaggio. 6x1 Maschio (10 pezzi)	913331703	10,00		Centric union filter Filtro termostatico	919416401	3,00
	Fixing screw for single-lever mixer lever. 5 Male. (10 pcs.) Vite di fissaggio della leva. 5 Maschio (10 pezzi)	913400831	8,00		O-ring NBR 17,17x1,78 mm. Giunta torica NBR 17,17x1,78 mm.	9534294501	2,00
	Fixing screw for single-lever mixer lever. 5 Male Vite di fissaggio della leva. 5 Maschio	9134008311	3,00		O-ring NBR 70SH 18x2,2 mm. Giunta torica NBR 70SH 18x2,2 mm.	9533315501	2,00
	Mixer top with chain holder Tappo di supporto catena	932010331	3,00		O-ring NBR 70SH 18x2,2 mm. (10 pcs.) Giunta torica NBR 70SH 18x2,2 mm. (10 pezzi)	953331550	8,00
	Grease pot Latta ingrassante	9134882	7,00		O-ring NBR 70SH 41x2,5 mm. Giunta torica NBR 70SH 41x2,5 mm.	9530440521	2,00
	Key for concealed aerator 16,5 Male Chiave ariatore Maschio 16,5	9134895	3,00		O-rings NBR 70SH 41x2,5 mm. (10 pcs.) Giunta torica NBR 70SH 41x2,5 mm. (10 pezzi)	953044052	7,00
	Key for concealed aerator 18,5 Male Chiave ariatore Maschio 18,5	9134896	3,00		O-ring EPDM 70SH 18,72x2,62 mm. Giunta torica EPDM 70SH 18,72x2,62 mm.	9533317501	2,00
	Key for concealed aerator 24 Male Chiave ariatore Maschio 24	9134897	3,00		O-rings EPDM 70SH 18,72x2,62 mm. (10 pcs.) Giunta torica EPDM 70SH 18,72x2,62 mm. (10 pezzi)	953331750	7,00
	Key for rectangular concealed aerator Chiave ariatore rettangolare	9134898	3,00		Extender for wall-mounted tapware Prolunga per kit di miscelazione a muro 2 unità maschio-femmina di 6 cm di lunghezza con silenziatore.	9134872	35,00
	Key for aerators Chiave ariatore	9134891	6,00		Extension set for the concealed single-handle washbasin mixer tap Set di estensione per miscelatori monocomando a incasso per lavabo	21830010	45,00
	Electronic tap distance sensor controller Regolatore del sensore di distanza della rubinetteria elettronica	299392134	10,00		Extension set for the Rapid-box 2-way concealed single-handle mixer taps Set di estensione per miscelatori monocomando a incasso 2 getti Rapid-box	29928010	50,00
	Nut locking key Chiave bloccaggio madrevite	9134893	3,00		Extension set for the Base/Base Plus 2-way concealed single-handle mixer taps Set di estensione per miscelatori monocomando a incasso 2 getti Base/Base Plus	29928011	84,00
	Key to remove the diverter for wall-mounted bath tap Chiave	29989603	21,00		Extension set for the Therm-box 2-way concealed thermostatic taps Set di estensione per rubinetteria termostatica a incasso 2 getti Therm-box	29985001	36,00
	Multipurpose key Chiave multipla	9134890	11,00		Extension set for the B-System 1-2-way concealed thermostatic taps Set di estensione per rubinetteria termostatica a incasso 1-2 getti B-System	29985002	40,00
	Key + Loft cartridge insert Chiave + inserto cartuccia Loft	29989602	17,00		Extension set for the B-System 3-4-way concealed thermostatic taps Set di estensione per rubinetteria termostatica a incasso 3-4 getti B-System	29985003	50,00



PRODUCT LIST / ELENCO DEI RIFERIMENTI

Ref./Rif.	Price	Ref./Rif.	Price	Ref./Rif.	Price	Ref./Rif.	Price	Ref./Rif.	Price
00									
00610101	163,00	00625004AC	922,00	006486BM	651,00	01210003	86,00	03453430KM	107,00
00610101AC	252,00	00625004BM	922,00	006486NM	651,00	01210302	93,00	03453430KMB	107,00
00610101BL	252,00	00625004NM	922,00	006486OM	924,00	01210303	97,00	03453430LM	100,00
00610101BM	252,00	00625004OM	1.256,00	00648701	485,00	01217901	630,00	03453430LV	100,00
00610101D	186,00	00625004OR	1.256,00	00648701AC	752,00	01220002	74,00	03453430NM	107,00
00610101NE	252,00	00625005	1.180,00	00648701BM	752,00	01220703	130,00	03453430OM	152,00
00610101NM	252,00	00625005AC	1.761,00	00648701NM	752,00	01220704	185,00	03453430OP	152,00
00610101OM	358,00	00625005BM	1.761,00	00660502AC	394,00	01220801	80,00	03453430OPM	152,00
00610101OR	358,00	00625005NM	1.761,00	00660502BM	394,00	01240801	68,00	03453430OR	152,00
00610102	163,00	00625005OM	2.447,00	00660502NM	394,00	01240850	152,00	03453440AC	146,00
00610102D	186,00	00625005OR	2.447,00	00660502OM	559,00	01299601	273,00	03453440NM	146,00
00611001	278,00	00625006	542,00	00660502OR	559,00	02			
00611001BL	431,00	00625006AC	769,00	00660602AC	426,00	02351501	46,00	03453440OM	208,00
00611001D	301,00	00625006BM	769,00	00660602BM	426,00	02352001C	43,00	03453440OR	208,00
00611001NE	431,00	00625006NM	769,00	00660602NM	426,00	02352001F	43,00	03463430AC	74,00
00611002	278,00	00625006OM	1.039,00	00660602OM	605,00	02418201	50,00	03463430BM	74,00
00611002BL	431,00	00625006OR	1.039,00	00660602OR	605,00	02463609AC	121,00	03463430KMB	74,00
00611002D	301,00	00628003	559,00	00660702AC	443,00	02463609LM	113,00	03463430LM	74,00
00611002NE	431,00	00628003AC	818,00	00660702BM	443,00	02463609OR	172,00	03463430LV	74,00
00612001	166,00	00628003BM	818,00	00660702NM	443,00	03			
00612001AC	257,00	00628003NM	818,00	00660702OM	628,00	030335AC	395,00	03463430NM	74,00
00612001BL	257,00	00628003OM	1.125,00	00660702OR	628,00	030335BM	395,00	03463430OM	198,00
00612001BM	257,00	00628003OR	1.125,00	00661001	313,00	030335NM	395,00	03463430OP	198,00
00612001D	189,00	00628004	582,00	00661001AC	485,00	030335OM	561,00	03463430OPM	198,00
00612001NE	257,00	00628004AC	853,00	00661001BL	485,00	030336AC	372,00	03463430OR	198,00
00612001NM	257,00	00628004BM	853,00	00661001BM	485,00	030336BM	372,00	03463501AC	177,00
00612001OM	365,00	00628004NM	853,00	00661001NE	485,00	030336OM	372,00	03463501BM	177,00
00612001OR	365,00	00628004OM	1.174,00	00661001NM	485,00	03043401	183,00	03463501OM	177,00
00612301	200,00	00628004OR	1.174,00	00661001OM	688,00	03044401	204,00	03463501KMB	177,00
00612301AC	310,00	00628005	1.097,00	00661001OR	688,00	03048501	300,00	03463501NM	177,00
00612301BM	310,00	00628005AC	1.654,00	00661002	313,00	03049601	471,00	03463501OPM	251,00
00612301D	310,00	00628005BM	1.654,00	00663901	46,00	0304960M	669,00	03463502AC	161,00
00612301NE	440,00	00628005NM	1.654,00	00663901AC	71,00	03411601	41,00	03463502BM	161,00
00612301NM	440,00	00628005OM	2.312,00	00663901BM	71,00	03411601AC	64,00	03463502KMB	161,00
00612301OM	440,00	00628005OR	2.312,00	00663901NM	71,00	03411601BM	64,00	03463502NM	161,00
00612301OR	440,00	00628006	459,00	00663901OP	101,00	03411601KM	64,00	03463502OPM	229,00
00612302	240,00	00628006AC	662,00	00663901OPM	101,00	03411601KMB	64,00	03463505AC	239,00
00612302AC	372,00	00628006BM	662,00	00663901OR	101,00	03411601NM	64,00	03463505BM	239,00
00612302BM	372,00	00628006NM	662,00	00681001	383,00	03411601OM	90,00	03463505KMB	239,00
00612302NM	372,00	00628006OM	903,00	00681001AC	594,00	03411601OP	90,00	03463505NM	239,00
00612402AC	361,00	00628006OR	903,00	00681001BL	594,00	03411601OPM	90,00	03463505OM	339,00
00612402BM	361,00	00630021	157,00	00681001BM	594,00	03411601OR	90,00	03463505OPM	339,00
00612402NM	361,00	00630021AC	243,00	00681001NE	594,00	03412102	142,00	03463506AC	223,00
00612402OM	513,00	00630021BM	243,00	00681001NM	594,00	03412401	37,00	03463506BM	223,00
00612402OR	513,00	00630021NM	243,00	00681001OM	594,00	03412401AC	57,00	03463506KMB	223,00
00616103	410,00	00630021OM	345,00	00681001OR	843,00	03412401BM	57,00	03463506NM	223,00
00616103AC	636,00	00630021OR	345,00	00681002	383,00	03412401KM	57,00	03463506OPM	223,00
00616103BM	636,00	00630022	167,00	00698003	582,00	03412401KMB	57,00	03463506OM	317,00
00616103NM	636,00	00630022AC	259,00	00712001	166,00	03412401NM	57,00	03463506OPM	317,00
00616103OM	902,00	00630022BM	259,00	00712001AC	257,00	03412401OM	81,00	03463701	86,00
00616103OR	902,00	00630022NM	259,00	00712001BL	257,00	03412401OP	81,00	03463701AC	133,00
00616104	473,00	00630022OM	367,00	00712001BM	257,00	03412401OPM	81,00	03463701BM	133,00
00616105	462,00	00630022OR	367,00	00712001D	189,00	03412401OR	81,00	03463701KMB	133,00
00616105AC	716,00	00630023	210,00	00712001E	257,00	03412402	47,00	03463701NM	133,00
00616105BM	716,00	00630023AC	326,00	00712001NE	257,00	03412402AC	73,00	03463701OM	189,00
00616105NM	716,00	00630023BM	326,00	00712001NM	257,00	03412402BM	73,00	03463701OPM	189,00
00616105OM	1.016,00	00630023OM	462,00	00712001OM	365,00	03412402NM	73,00	03463702	64,00
00616105OR	1.016,00	00630023OR	462,00	00712001OR	365,00	03412402OM	104,00	03463706	33,00
00616106	400,00	00630031	190,00	00715501	89,00	03412402OR	104,00	03463708	95,00
00618080	550,00	00630031AC	295,00	00715501AC	137,00	03416101	80,00	03463709	67,00
00618301	63,00	00630031BM	295,00	00715501BM	137,00	03423101	159,00	03463709NM	104,00
00618301NM	98,00	00630031NM	295,00	00715501NM	137,00	03433603	118,00	03463820AC	78,00
00620101	170,00	00630031OR	295,00	00715501OR	196,00	03433604	155,00	03463820BM	78,00
00620101AC	264,00	00630032AC	310,00	00716703BM	485,00	03443101	350,00	03463820KMB	78,00
00620101BM	264,00	00630032BM	310,00	00716703NM	485,00	03443202	270,00	03463820LM	78,00
00620101NM	264,00	00630032NM	310,00	00716703OM	688,00	03443203	425,00	03463820LV	78,00
00620101OM	374,00	00630032OM	440,00	00716703OR	688,00	03450101	26,00	03463820NM	78,00
00620101OR	374,00	00630032OR	440,00	0071700203BM	518,00	03450102	28,00	03463820OM	78,00
00620501AC	407,00	00630033	240,00	0071700203NM	518,00	03452602	118,00	03463820OPM	211,00
00620501BM	407,00	00630033AC	372,00	0071700203OM	735,00	03453202	155,00	03463820OR	211,00
00620501NM	407,00	00630033BM	372,00	0071700203OR	735,00	03453420AC	50,00	03463901AC	60,00
00620501OM	578,00	00630033NM	372,00	00719101	635,00	03453420BM	50,00	03463901BM	60,00
00620501OR	578,00	00630033OM	528,00	00719102	680,00	03453420KMB	50,00	03463901OM	60,00
00625001	137,00	00630033OR	528,00	00719701	582,00	03453420LV	46,00	03463901NM	60,00
00625001AC	212,00	006437BM	646,00	00719702	626,00	03453420NM	50,00	03463901OPM	86,00
00625001BM	212,00	006437NM	646,00	00750301AC	244,00	03453420OM	70,00	03463901OP	86,00
00625001NM	212,00	006437OM	917,00	00750301BM	244,00	03453420OPM	70,00	03463901OR	86,00
00625001OM	300,00	00648501	305,00	00750301NM	244,00	03453420OR	70,00	03464501	145,00
00625001OR	300,00	00648501AC	472,00	00750301OR	347,00	03453430AC	107,00	03464501AC	225,00
00625003	620,00	00648501BM	472,00	01					
00625003AC	888,00	00648501NM	472,00	01210002	83,00	03453430BM	107,00		
00625003BM	888,00	00648501OM	670,00						
00625003NM	888,00	00648501OR	670,00						
00625003OM	1.207,00								
00625003OR	1.207,00								
00625004	641,00								

Ref./Rif.	Price		Ref./Rif.	Price		Ref./Rif.	Price		Ref./Rif.	Price		Ref./Rif.	Price	
03464501BM	225,00	389	06115501OP	182,00	496	06243201AC	132,00	368	09286556	1.294,00	265	10710342AC	310,00	491
03464501KMB	225,00	389	06115501OPM	182,00	496	06243201BM	132,00	368	09286557	1.766,00	264	10710342BM	310,00	491
03464501NM	225,00	389	06115501OR	182,00	496	06243201KMB	132,00	368	09286558	1.195,00	262	10710342KMB	310,00	491
03464501OM	319,00	389	06116701	215,00	161	06243201KMM	132,00	368	09286558OM	1.766,00	262	10710342NM	310,00	491
03464501OPM	319,00	389	06117001	236,00	161	06243201NM	132,00	368	09286558OPM	1.766,00	262	10710342OPM	440,00	491
03464502	160,00	389	06117202	108,00	500	06243201OM	187,00	368	09286561	1.766,00	264	10710342OM	440,00	491
03474007	25,00	490	06118301	35,00	397	06243201OP	187,00	368	09286562	2.064,00	263	10710342OP	440,00	491
03474501	40,00	491	06120301	125,00	157	06243201OPM	187,00	368	09286563	1.242,00	262	10710342OPM	440,00	491
03474501AC	62,00	491	06120301D	148,00	157	06243201OR	187,00	368	09286563OM	1.831,00	262	10710342OR	440,00	491
03474501LM	58,00	491	06120304	217,00	158	062435AC	411,00	437	09286563OPM	1.831,00	262	107103DA	183,00	99
03474501OM	104,00	491	06120601	217,00	157	062435BM	411,00	437	09286564	1.190,00	263	107131	373,00	392
03474501OR	104,00	491	06122001	130,00	160	062435NM	411,00	437	09286564OM	1.757,00	263	10716102	880,00	111
03474601	32,00	488	06122001D	153,00	160	062435OM	583,00	437	09286564OPM	1.757,00	263	107167	313,00	104
03474601AC	50,00	488	06144701	278,00	422	06243601AC	357,00	437	09286567	1.181,00	263	10717002	334,00	104
03474601LM	46,00	488	06144801	310,00	423	06243601BM	357,00	437	09286567OM	1.692,00	263	107181	200,00	499
03474601OM	70,00	488	06151101	91,00	496	06243601NM	357,00	437	09286567OPM	1.692,00	263	10723601	65,00	410
03474601OR	70,00	488	06151101AC	140,00	496	06243601OM	506,00	437	09288308NM	1.978,00	265	10710342OP	101,00	410
03483102	318,00	358	06151101BM	140,00	496	06250301	46,00	478	09288315NM	2.649,00	267	10723601BM	101,00	410
03493101	197,00	387	06151101KMB	140,00	496	06254201	224,00	439	09288404NM	3.756,00	268	10723601KMB	101,00	410
03493101AC	305,00	387	06151101KMM	140,00	496	06254201AC	347,00	439	09288408NM	2.896,00	267	10723601NM	101,00	410
03493101BM	305,00	387	06151101NM	140,00	496	06254201BM	347,00	439	09288551NM	1.718,00	262	10723601OM	101,00	410
03493101NM	305,00	387	06151101OM	199,00	496	06254201NM	347,00	439	09288552NM	2.050,00	264	10723601OPM	143,00	410
03493199	142,00	384	06151101OP	199,00	496	06254201OM	493,00	439	09288555NM	2.039,00	265	10723601OR	143,00	410
03493199AC	220,00	384	06151101OPM	199,00	496	06260301	48,00	478	09288556NM	1.577,00	265	10723601OPM	143,00	410
03493199BM	220,00	384	06151101OR	199,00	496	06298001	513,00	164	09288557NM	2.300,00	264	10723601OR	143,00	410
03493199KMB	220,00	384	06163505	255,00	393	06298004	442,00	164	09288558NM	1.301,00	262	10723603	68,00	410
03493199NM	220,00	384	06163506	336,00	391	06944001	106,00	441	09288561NM	2.310,00	264	10723603AC	106,00	410
03493199OM	312,00	384	06163509	310,00	393	06944401	204,00	454	09288563NM	1.346,00	262	10723603BM	106,00	410
03493199OPM	312,00	384	06183901AC	45,00	394	06944701	102,00	442	09288564NM	1.296,00	263	10723603KMB	106,00	410
03493201	204,00	387	06183901BM	45,00	394				09288567NM	1.250,00	263	10723603NM	106,00	410
03493201AC	316,00	387	06183901KMB	45,00	394	07			09598101	183,00	413	10723603OM	150,00	410
03493201BM	316,00	387	06183901KMM	45,00	394	07032003	100,00	459	09598101AC	290,00	413	10723603OP	150,00	410
03493201NM	316,00	387	06183901OM	64,00	394	07044802	108,00	442	09598101BM	290,00	413	10723603OPM	150,00	410
03493299	149,00	383	06183901OPM	64,00	394	07099501	313,00	469	09598101KMB	290,00	413	10723603OR	150,00	410
03493299AC	231,00	383	06183901OR	64,00	394	08			09598101KMM	290,00	413	10723606	32,00	410
03493299BM	231,00	383	06192801	115,00	385	081192	399,00	176	09598101NM	290,00	413	10723606AC	50,00	410
03493299KMB	231,00	383	06193102	134,00	388	08119301	425,00	177	09598101OP	411,00	413	10723606BM	50,00	410
03493299NM	231,00	383	06193103	131,00	387	08119302	433,00	177	09598101OPM	411,00	413	10723606KMB	50,00	410
03493299OM	328,00	383	06193104	155,00	388	08119701	451,00	178	09598101OR	411,00	413	10723606NM	50,00	410
03493299OPM	328,00	383	06193105	151,00	387	08119702	475,00	176	09598102AC	257,00	413	10723606OP	83,00	410
06			06210301	109,00	157	08119703	470,00	175	09598102BM	257,00	413	10723606OPM	83,00	410
06110301	109,00	157	06210301D	132,00	157	08119704	497,00	177	09598102KMB	257,00	413	10723606OPM	83,00	410
06110301D	132,00	157	06210302	127,00	158	08120001	242,00	172	09598102KMM	257,00	413	10723620	28,00	410
06110302	127,00	158	06210302D	150,00	158	08120002	252,00	172	09598102NM	257,00	413	10723620AC	43,00	410
06110302D	150,00	158	06212001	112,00	160	08333301	168,00	443	09598102OP	365,00	413	10723620BM	43,00	410
06110501	278,00	81	06212001AC	273,00	84	09			09598102OPM	365,00	413	10723620KMB	43,00	410
06110501AC	431,00	81	06212001BM	273,00	84	09217101	273,00	422	09598102OR	365,00	413	10723620NM	43,00	410
06110501BM	431,00	81	06212001D	135,00	160	09226201	1.176,00	55				10723620OM	62,00	410
06110501KMB	431,00	81	06212001KMB	273,00	84	09226201AC	1.640,00	55	10			10723620OP	62,00	410
06110501KMM	431,00	81	06212001NM	273,00	84	09226201LM	1.624,00	55	104841	42,00	490	10723620OPM	62,00	410
06110501OM	612,00	81	06212001OM	388,00	84	09226201LV	1.624,00	55	106103	160,00	98	10723620OR	62,00	410
06110501OP	612,00	81	06212001OP	388,00	84	09226201OR	2.158,00	55	106103DA	183,00	98	10733605	77,00	410
06110501OPM	612,00	81	06212001OPM	388,00	84	09226202	1.213,00	55	106124	233,00	103	10733605AC	119,00	410
06110501OR	612,00	81	06212001OR	388,00	84	09226202AC	1.596,00	55	10616102	890,00	111	10733605BM	119,00	410
06110502	294,00	82	06212001TAM	273,00	84	09226202LM	1.589,00	55	10617710	126,00	108	10733605KMB	119,00	410
06110502AC	456,00	82	06212001TRO	273,00	84	09226202LV	1.589,00	55	10618100	210,00	108	10733605NM	119,00	410
06110502BM	456,00	82	06216102	360,00	166	09226202OR	2.095,00	55	10620501	263,00	99	10733605OP	231,00	410
06110502KMB	456,00	82	06216103	350,00	165	09226301	1.383,00	55	106245	415,00	406	10733605OPM	231,00	410
06110502KMM	456,00	82	06217702	116,00	164	09226301AC	1.834,00	55	10627810	89,00	322	107476	378,00	390
06110502NM	456,00	82	06218002	179,00	164	09226301LM	1.805,00	55	10627810AC	138,00	322	107503	158,00	100
06110502OM	647,00	82	06218080	479,00	165	09226301LV	1.805,00	55	10627810BM	138,00	322	107511	96,00	496
06110502OP	647,00	82	06218081	414,00	165	09226301OR	2.422,00	55	10627810KMB	138,00	322	107839	31,00	394
06110502OPM	647,00	82	06220301	125,00	157	09226302	1.355,00	56	10628110	116,00	324	107839BM	48,00	394
06110502OR	647,00	82	06220301D	148,00	157	09226302AC	1.791,00	56	10628110AC	179,00	324	107839NM	48,00	394
06112001	112,00	160	06220304	217,00	158	09226302LM	1.770,00	56	10628110BM	179,00	324	107839OM	68,00	394
06112001AC	174,00	84	06220601	217,00	158	09226302LV	1.770,00	56	10628110NM	179,00	324	107839OR	68,00	394
06112001BM	273,00	84	06222001	130,00	160	09226302OR	2.340,00	56	10628110OM	254,00	324	107922	68,00	380
06112001D	135,00	160	06222001D	153,00	160	09244501AC	345,00	455	10627810OR	196,00	322	107926	375,00	390
06112001KMB	273,00	84	06225001	116,00	284	09244601	310,00	455	10628110	116,00	324	107935	139,00	381
06112001KMM	273,00	84	06225003	480,00	290	092486302	3.005,00	266	10628110AC	179,00	324			
06112001NM	273,00	84	06225004	515,00	288	09286304	2.249,00	266	10628110BM	179,00	324	11		
06112001OM	388,00	84	06225005	1.131,00	292	09286308	1.678,00	266	10628110KMB	179,00	324	112100	85,00	472
06112001OP	388,00	84	06225006	436,00	293	09286308OM	1.611,00	265	10628110NM	179,00	324	112103	103,00	471
06112001OPM	388,00	84	06											

PRODUCT LIST / ELENCO DEI RIFERIMENTI

Ref./Rif.	Price		Ref./Rif.	Price		Ref./Rif.	Price		Ref./Rif.	Price		Ref./Rif.	Price	
112178	94,00	474	134100108	32,00	513	134315007OR	451,00	362	13462101	65,00	366	134944	820,00	356
112200	89,00	472	13410010816	486,00	513	134315008	260,00	361	13462102	60,00	368	134944AC	1.271,00	356
112205	104,00	473	134122	230,00	85	134315008AC	403,00	361	13462102AC	93,00	368	134944BM	1.271,00	356
112370	230,00	464	134122AC	357,00	85	134315008BM	403,00	361	13462102BM	93,00	368	134944NM	1.271,00	356
112441	40,00	463	134122BM	357,00	85	134315008NM	403,00	361	13462102KMB	93,00	368	134944OM	1.804,00	356
114444	315,00	453	134122NM	357,00	85	134315008OM	572,00	361	13462102NM	93,00	368	134944OR	1.804,00	356
117333	93,00	444	134123	190,00	84	134315008OR	572,00	361	13462102OM	132,00	368	134950	1.030,00	356
117440	112,00	441	134123AC	295,00	84	134315009	98,00	365	13462102OP	132,00	368	13495001	775,00	357
			134123BM	295,00	84	134315010	145,00	364	13462102OPM	132,00	368	13495001AC	1.201,00	357
			134123KM	295,00	84	134315010AC	225,00	364	13462102OR	132,00	368	13495001BM	1.201,00	357
			134123KMB	295,00	84	134315010BM	225,00	364	13462104	77,00	366	13495001KM	1.201,00	357
123100C	36,00	252	134123NM	295,00	84	134315010KM	225,00	364	13462104AC	119,00	366	13495001KMB	1.201,00	357
123100F	36,00	252	134123OM	418,00	84	134315010NM	225,00	364	13462104BM	119,00	366	13495001NM	1.201,00	357
123103	108,00	252	134123OP	418,00	84	134315010OM	319,00	364	13462104KM	119,00	366	13495001OM	1.705,00	357
123120	111,00	252	134123OPM	418,00	84	134315010OPM	319,00	364	13462104KMB	119,00	366	13495001OP	1.705,00	357
123125C	40,00	252	134123OR	418,00	84	134315010OR	319,00	364	13462104OP	169,00	366	13495001OPM	1.705,00	357
123125F	40,00	252	13413726	82,00	365	134315011	145,00	362	13462104OPM	169,00	366	13495002AC	1.335,00	356
123155C	33,00	254	13413726	82,00	365	134315012	172,00	362	13462104OR	169,00	366	13495002BM	1.335,00	356
123155F	33,00	254	13413730	256,00	364	134315012AC	267,00	362	13462202	77,00	368	13495002KM	1.335,00	356
123167	118,00	253	13413730AC	397,00	364	134315012BM	267,00	362	13462202AC	119,00	368	13495002KMB	1.335,00	356
123170	160,00	253	13413730BM	397,00	364	134315012KM	267,00	362	13462202BM	119,00	368	13495002NM	1.335,00	356
123210	75,00	457	13413730KMB	397,00	364	134315012NM	267,00	362	13462202NM	119,00	368	13495002OM	1.894,00	356
123214	76,00	457	13413730KMB	397,00	364	134315012OM	378,00	362	13462202OM	169,00	368	13495002OP	1.894,00	356
123215	78,00	457	13413730NM	397,00	364	134315012OPM	378,00	362	134627	17,00	374	13495002OPM	1.894,00	356
123217	97,00	459	13413730OM	563,00	364	134315012OPM	378,00	362	134628	122,00	386	13495002OR	1.894,00	356
123230	80,00	457	13413730OP	563,00	364	134315012OR	378,00	362	134629	137,00	386	13495002OR	1.894,00	356
123306	52,00	464	13413730OPM	563,00	364	134315014	220,00	362	13463301	79,00	367	13495002OR	1.894,00	356
123310	78,00	456	13413730OR	563,00	364	134315015	172,00	364	13463302	79,00	367	13495002OR	1.894,00	356
123314	78,00	458	13413826	82,00	363	13431513	46,00	366	13463303	77,00	367	13495002OR	1.894,00	356
123315	80,00	458	13413830	268,00	362	134331	185,00	358	13463304	44,00	369	13495002OR	1.894,00	356
123317	99,00	459	13413830AC	415,00	362	13434010	30,00	483	13463310	14,00	488	13495002OR	1.894,00	356
123330	82,00	458	13413830BM	415,00	362	13434020	30,00	487	13463340	43,00	493	13495002OR	1.894,00	356
123342	85,00	456	13413830KMB	415,00	362	13434120	30,00	486	134634010NM	67,00	493	13495002OR	1.894,00	356
123360	86,00	458	13413830KMB	415,00	362	134432	220,00	361	13463420	63,00	493	13495002OR	1.894,00	356
123416	96,00	458	13413830NM	415,00	362	134433	340,00	360	13463420NM	98,00	493	13495002OR	1.894,00	356
123500C	25,00	253	13413830OM	590,00	362	134445	100,00	490	13463430	32,00	492	13495002OR	1.894,00	356
123500F	25,00	253	13413830OP	590,00	362	134512	105,00	385	13463440	23,00	493	13495002OR	1.894,00	356
123505	40,00	464	13413830OPM	590,00	362	13451501	473,00	399	13463450	23,00	488	13495002OR	1.894,00	356
123510C	59,00	252	13413940	90,00	366	13451501AC	732,00	399	13463460	5,00	494	13495002OR	1.894,00	356
123510F	59,00	252	13413940AC	140,00	366	13451501BM	732,00	399	13463810	22,00	493	13495002OR	1.894,00	356
123511C	31,00	254	13413940BM	140,00	366	13451501KM	732,00	399	13463820	34,00	492	13495002OR	1.894,00	356
123511F	31,00	254	13413940NM	140,00	366	13451501KMB	732,00	399	13463910	13,00	487	13495002OR	1.894,00	356
123512C	30,00	254	13413940OM	198,00	366	13451501NM	732,00	399	134714	530,00	356	13495002OR	1.894,00	356
123512F	30,00	254	13413940OPM	198,00	366	13451501OM	1.040,00	399	134715	530,00	357	13495002OR	1.894,00	356
123513C	29,00	255	13416703	80,00	475	13451501OP	1.040,00	399	134738	56,00	370	13495002OR	1.894,00	356
123513F	29,00	255	13416703	80,00	475	13451501OPM	1.040,00	399	13473850	20,00	370	13495002OR	1.894,00	356
123515	43,00	254	13416803	103,00	475	13451501OR	1.040,00	399	13474010	20,00	491	13495002OR	1.894,00	356
123520C	36,00	253	134184	39,00	411	134516	68,00	380	13474010AC	31,00	491	13495002OR	1.894,00	356
123520F	36,00	253	134184AC	60,00	411	134517	100,00	380	13474010BM	31,00	491	13495002OR	1.894,00	356
12423601	78,00	412	134184BM	60,00	411	134520	100,00	380	13474010KMB	31,00	491	13495002OR	1.894,00	356
12423601AC	121,00	412	134184KM	60,00	411	13452102	50,00	369	13474010KMB	31,00	491	13495002OR	1.894,00	356
12423601LM	113,00	412	134184KMB	60,00	411	13452102AC	78,00	369	13474010NM	31,00	491	13495002OR	1.894,00	356
12423601LV	113,00	412	134184NM	60,00	411	13452102BM	78,00	369	13474010OM	44,00	491	13495002OR	1.894,00	356
12423601OR	172,00	412	134184OM	100,00	411	13452102KM	78,00	369	13474010OP	44,00	491	13495002OR	1.894,00	356
12423603	82,00	412	134184OP	100,00	411	13452102KMB	78,00	369	13474010OPM	44,00	491	13495002OR	1.894,00	356
12423603AC	127,00	412	134184OPM	100,00	411	13452102NM	78,00	369	13474010OR	44,00	491	13495002OR	1.894,00	356
12423603LM	119,00	412	134184OR	100,00	411	13452102OM	110,00	369	13474020	9,00	491	13495002OR	1.894,00	356
12423603LV	119,00	412	13420503	66,00	473	13452102OP	110,00	369	13474110	24,00	413	13499501	1.570,00	468
12423603OR	180,00	412	134215023	7,00	395	13452102OPM	110,00	369	13474110AC	37,00	413	13499502	1.675,00	468
12423606	52,00	412	134215024	16,00	493	13452102OR	110,00	369	13474110BM	37,00	413	13499503	1.045,00	469
12423606AC	81,00	412	134215025	19,00	486	134522	141,00	385	13474110NM	37,00	413	13499504	1.780,00	468
12423606LM	75,00	412	134215026	13,00	485	13452202	67,00	368	13474110OM	53,00	413	139441	85,00	441
12423606LV	75,00	412	134215027	14,00	491	13452202AC	104,00	368	13474210	13,00	495			
12423606OR	114,00	412	134215028	19,00	485	13452202BM	104,00	368	13474220	16,00	495			
12423607	22,00	413	134221	125,00	358	13452202NM	104,00	368	13474310	18,00	487			
12423607AC	34,00	413	134232	151,00	361	13452202OM	147,00	368	13474320	17,00	487			
12423607LM	32,00	413	134233	163,00	360	13452202OR	147,00	368	13474330	17,00	487			
12423607LV	32,00	413	13424010	23,00	484	13453410	35,00	489	134748	48,00	372			
12423607OR	48,00	413	13424020	29,00	484	13453420	32,00	489	134757	23,00	398			
12463609	80,00	412	13424030	24,00	484	13453430	69,00	489	134808	39,00	370			
			134302	55,00	500	13453440	95,00	489	134818	86,00	369			
			134303	59,00	501	13454010	25,00	484	134870	89,00	498			
			134315001	57,00	365	13454030	38,00	485	134871	102,00	498			
			134315002	77,00	363	13454050	22,00	485	134940	820,00	357			
			134315003	103,00	365	13454060	25,00	484	134940AC	1.271,00	357			
			134315004	125,00	363	13454070	18,00	485	134940BM	1.271,00	357			
			134315005	130,00	365	13454110	22,							

Ref./Rif.	Price	Ref./Rif.	Price	Ref./Rif.	Price	Ref./Rif.	Price	Ref./Rif.	Price					
16118740BM	119,00	367	17031802	102,00	461	19016429AC	366,00	310	19017414OM	751,00	313	19031205NM	997,00	308
16118740KMB	119,00	367	17032002	107,00	460	19016429BM	366,00	310	19017414OPM	751,00	313	19031205OM	1.415,00	308
16118740NM	119,00	367	17033202	118,00	461	19016429KMB	366,00	310	19017415	341,00	312	19031205OPM	1.415,00	308
16118740OM	169,00	367	17033302	85,00	444	19016429NM	366,00	310	19017415AC	529,00	312	19031212	654,00	309
16118740OP	169,00	367	17041802	105,00	460	19016429OM	520,00	310	19017415BM	529,00	312	19031212AC	1.014,00	309
16118740OPM	169,00	367	17044002	108,00	442	19016429OPM	520,00	310	19017415KMB	529,00	312	19031212BM	1.014,00	309
16118740OR	169,00	367	17044102	76,00	441	19016439	236,00	311	19017415NM	529,00	312	19031212KMB	1.014,00	309
161194	310,00	497	17044702	102,00	443	19016439AC	366,00	311	19017415OM	751,00	312	19031212NM	1.014,00	309
161194AC	481,00	497	172218	108,00	461	19016439BM	366,00	311	19017415OPM	751,00	312	19031212OPM	1.439,00	309
161194NM	481,00	497	172317	108,00	459	19016439KMB	366,00	311	19017419	288,00	200	19031212OPM	1.439,00	309
161194OM	682,00	497	172318	118,00	459	19016439NM	366,00	311	19017419NM	446,00	200	19031215	685,00	308
161194OPM	682,00	497	17231811	200,00	476	19016439OM	520,00	311	19017428	388,00	313	19031215AC	1.062,00	308
161213	342,00	393	172333	82,00	444	19016439OPM	520,00	311	19017428AC	601,00	313	19031215BM	1.062,00	308
161214	315,00	392	17233311	154,00	476	19016449	236,00	311	19017428BM	601,00	313	19031215KMB	1.062,00	308
16123601	60,00	411	172418	98,00	461	19016449AC	366,00	311	19017428KMB	601,00	313	19031215NM	1.062,00	308
16123601AC	93,00	411	172420	118,00	461	19016449BM	366,00	311	19017428NM	601,00	313	19031215OM	1.507,00	308
16123601BM	93,00	411	172440	112,00	442	19016449KMB	366,00	311	19017428OPM	854,00	313	19031215OPM	1.507,00	308
16123601KM	93,00	411	172447	102,00	443	19016449NM	366,00	311	19017429	320,00	313	19038501	475,00	201
16123601KMB	93,00	411	172450	130,00	477	19016449OM	520,00	311	19017429AC	496,00	313	19038701	480,00	201
16123601NM	93,00	411				19016449OPM	520,00	311	19017429BM	496,00	313	19038701NM	744,00	201
16123601OM	132,00	411				19016459	236,00	310	19017429KMB	496,00	313	19038702	609,00	303
16123601OP	132,00	411	1811103	109,00	171	19016459AC	366,00	310	19017429NM	496,00	313	19038702AC	944,00	303
16123601OPM	132,00	411	1811113	194,00	174	19016459BM	366,00	310	19017429OM	705,00	313	19038702BM	944,00	303
16123601OR	132,00	411	1811120	112,00	173	19016459KMB	366,00	310	19017429OPM	705,00	313	19038702KMB	944,00	303
16123602	63,00	411	1811191	412,00	176	19016459NM	366,00	310	19017429OPM	705,00	313	19038702NM	944,00	303
16123602AC	98,00	411	18119102	412,00	175	19016459OM	520,00	310	19017439	320,00	314	19038702OPM	1.340,00	303
16123602BM	98,00	411	181203	135,00	171	19016459OPM	520,00	310	19017439AC	496,00	314	19038705	580,00	304
16123602KMB	98,00	411	181217	214,00	171	19016469	278,00	310	19017439BM	496,00	314	19038705AC	899,00	304
16123602KMB	98,00	411	181222	227,00	174	19016469AC	431,00	310	19017439KMB	496,00	314	19038705BM	899,00	304
16123602NM	98,00	411	181223	182,00	174	19016469BM	431,00	310	19017439NM	496,00	314	19038705KMB	899,00	304
16123602OM	139,00	411	181341	135,00	440	19016469NM	431,00	310	19017439OM	705,00	314	19038705NM	899,00	304
16123602OP	139,00	411	181436	210,00	437	19016469OM	612,00	310	19017439OPM	705,00	314	19038705OPM	1.276,00	304
16123602OPM	139,00	411	181437	255,00	453	19017401	243,00	200	19017449	320,00	314	19038706	583,00	304
16123602OR	139,00	411	181438	260,00	452	19017401NM	377,00	200	19017449AC	496,00	314	19038707	435,00	307
16123606	30,00	411	181468	173,00	175	19017402	273,00	313	19017449BM	496,00	314	19038708	489,00	306
16123606AC	47,00	411	181474	194,00	175	19017402AC	423,00	313	19017449KMB	496,00	314	19038709	539,00	305
16123606BM	47,00	411	181540	228,00	439	19017402BM	423,00	313	19017449NM	496,00	314	19038710	420,00	248
16123606KMB	47,00	411	181903	113,00	171	19017402KMB	423,00	313	19017449OPM	705,00	314	19039301	412,00	201
16123606NM	47,00	411	181920	117,00	173	19017402NM	423,00	313	19017459	320,00	312	19039301NM	639,00	201
16123606NM	47,00	411	183341	125,00	440	19017402OM	601,00	313	19017459AC	496,00	312	19039302	559,00	305
16123606OM	90,00	411	186103	132,00	171	19017402OPM	601,00	313	19017459BM	496,00	312	19039302AC	866,00	305
16123606OP	90,00	411	186120	135,00	173	19017403	273,00	314	19017459KMB	496,00	312	19039302BM	866,00	305
16123606OPM	90,00	411	186203	159,00	171	19017403AC	423,00	314	19017459NM	496,00	312	19039302KMB	866,00	305
16123606OR	90,00	411	186217	237,00	171	19017403BM	423,00	314	19017459OM	705,00	312	19039302NM	866,00	305
16123620	18,00	411	186920	140,00	173	19017403KMB	423,00	314	19017459OPM	705,00	312	19039302OPM	1.230,00	305
16123620AC	28,00	411	18718250	368,00	499	19017403NM	423,00	314	19017469	373,00	312	19039305	625,00	303
16123620BM	28,00	411				19017403OM	601,00	314	19017469AC	550,00	312	19039305AC	969,00	303
16123620KMB	28,00	411	19016401	178,00	200	19017403OPM	601,00	314	19017469BM	550,00	312	19039305BM	969,00	303
16123620NM	28,00	411	19016401NM	276,00	200	19017404	423,00	314	19017469NM	550,00	312	19039305KMB	969,00	303
16123620OM	40,00	411	19016402	189,00	310	19017404BM	423,00	314	19017469OPM	710,00	312	19039305NM	969,00	303
16123620OP	40,00	411	19016402AC	293,00	310	19017404KMB	423,00	314	19017479	388,00	314	19039305OPM	1.375,00	303
16123620OPM	40,00	411	19016402BM	293,00	310	19017404NM	423,00	314	19017479AC	601,00	314	19039306	671,00	302
16123620OR	40,00	411	19016402KMB	293,00	310	19017404OM	601,00	314	19017479BM	601,00	314	19039306AC	1.040,00	302
16133602	72,00	412	19016402NM	293,00	310	19017404OPM	601,00	314	19017479KMB	601,00	314	19039306BM	1.040,00	302
16133602AC	112,00	412	19016402OM	416,00	310	19017405	273,00	312	19017479NM	601,00	314	19039306KMB	1.040,00	302
16133602BM	112,00	412	19016402OPM	416,00	310	19017405AC	423,00	312	19017479OPM	854,00	314	19039306NM	1.040,00	302
16133602KM	112,00	412	19016403	189,00	311	19017405BM	423,00	312	19017479OPM	854,00	314	19039306OPM	1.230,00	305
16133602KMB	112,00	412	19016403AC	293,00	311	19017405KMB	423,00	312	19017489	388,00	312	19039307	924,00	304
16133602NM	112,00	412	19016403BM	293,00	311	19017405NM	423,00	312	19017489AC	601,00	312	19039307AC	924,00	304
16133602OM	216,00	412	19016403KMB	293,00	311	19017405OM	601,00	312	19017489BM	601,00	312	19039307BM	924,00	304
16133602OP	216,00	412	19016403NM	293,00	311	19017405OPM	601,00	312	19017489KMB	601,00	312	19039307KMB	924,00	304
16133602OPM	216,00	412	19016403OM	416,00	311	19017406	326,00	312	19017489NM	601,00	312	19039307NM	924,00	304
16133602OR	216,00	412	19016403OPM	416,00	311	19017406AC	505,00	312	19017489OPM	854,00	312	19039307OPM	1.311,00	304
161445	325,00	455	19016404	189,00	311	19017406BM	505,00	312	19017489OPM	854,00	312	19039308	961,00	302
161446	375,00	455	19016404AC	293,00	311	19017406NM	505,00	312	19017499	388,00	313	19039308AC	961,00	302
161475	257,00	392	19016404BM	293,00	311	19017406OM	716,00	312	19017499AC	601,00	313	19039308BM	961,00	302
161835	38,00	382	19016404KMB	293,00	311	19017412	341,00	313	19017499BM	601,00	313	19039308OM	1.364,00	302
161838	59,00	383	19016404NM	293,00	311	19017412AC	529,00	313	19017499KMB	601,00	313	19039309	587,00	303
161839	29,00	394	19016404OM	416,00	311	19017412BM	529,00	313	19017499NM	601,00	313	19039310	590,00	302
161840	44,00	483	19016404OPM	416,00	311	19017412KMB	529,00	313	19017499OPM	854,00	313	19039311	550,00	305
162161	790,00	166	19016405	189,00	310	19017412NM	529,00	313	19017499OPM	854,00	313	19039312	465,00	307
16216150	315,00	499	19016405AC	293,00	310	19017412OM	751,00	313	19019601	259,00	247	19039313	486,00	306
162245	415,00	406	19016405BM	293,00	310	19017412OPM	751,00	313	19026410	235,00	477	19039314		

PRODUCT LIST / ELENCO DEI RIFERIMENTI

Ref./Rif.	Price		Ref./Rif.	Price		Ref./Rif.	Price		Ref./Rif.	Price		Ref./Rif.	Price	
19039316	464,00	225	20017001OM	589,00	122	20020503OM	520,00	120	20210305AC	618,00	63	20227301	1.076,00	334
19039317	429,00	248	20017001OR	589,00	122	20020503OR	520,00	120	20210305BM	618,00	63	20227301AC	1.618,00	334
19039318	443,00	307	20017701	116,00	122	20020504	210,00	119	20210305KMB	618,00	63	20227301BM	1.618,00	334
19063502	362,00	391	20018001	179,00	122	20020504AC	326,00	119	20210305NM	618,00	63	20227301KMB	1.618,00	334
19063502BM	561,00	391	20018001AC	277,00	122	20020504BL	326,00	119	20210305OM	878,00	63	20227301NM	1.618,00	334
19063502KMB	561,00	391	20018001BM	277,00	122	20020504BM	326,00	119	20210305OR	878,00	63	20227301OM	2.258,00	334
19063502NM	561,00	391	20018001NM	277,00	122	20020504NE	326,00	119	20210306	399,00	64	20227301OR	2.258,00	334
19063502OM	797,00	391	20018001OM	393,00	122	20020504NM	326,00	119	20210501	389,00	64	20227302	1.445,00	336
19063502OPM	797,00	391	20018001OR	393,00	122	20020504OM	462,00	119	20210501AC	602,00	64	20227302AC	2.189,00	336
19063504	349,00	390	20018002	479,00	123	20020504OR	462,00	119	20210501BM	602,00	64	20227302BM	2.189,00	336
19063504AC	540,00	390	20018005	725,00	123	20020505	221,00	119	20210501NM	602,00	64	20227302KMB	2.189,00	336
19063504BM	540,00	390	20018005AC	1.124,00	123	20020505AC	342,00	119	20210501OM	855,00	64	20227302NM	2.189,00	336
19063504NM	540,00	390	20018005BM	1.124,00	123	20020505BL	342,00	119	20210501OR	855,00	64	20227302OM	3.069,00	336
19063504OM	767,00	390	20018005NM	1.124,00	123	20020505BM	342,00	119	20212001	196,00	67	20227302OR	3.069,00	336
19260603	305,00	419	20018005OM	1.596,00	123	20020505NE	342,00	119	20212001AC	304,00	67	20227303	786,00	335
19290603	347,00	422	20018005OR	1.596,00	123	20020505NM	342,00	119	20212001BM	304,00	67	20227303AC	1.203,00	335
			20018009	419,00	124	20020505OM	485,00	119	20212001D	219,00	67	20227303BM	1.203,00	335
			20018010	100,00	122	20020505OR	485,00	119	20212001KMB	304,00	67	20227303NM	1.203,00	335
			20018010AC	152,00	122	20020506	231,00	119	20212001NM	304,00	67	20227303OM	1.618,00	335
			20018010BM	152,00	122	20020506AC	358,00	119	20212001OM	432,00	67	20227303OR	1.618,00	335
			20018010NM	152,00	122	20020506BL	358,00	119	20212001OR	432,00	67	20227310	125,00	325
			20018010OM	221,00	122	20020506BM	358,00	119	20212002	196,00	67	20227310AC	194,00	325
			20018010OR	221,00	122	20020506NE	358,00	119	20212002D	219,00	67	20227310BM	194,00	325
			20018011	453,00	123	20020506NM	358,00	119	20216101	460,00	73	20227310NM	194,00	325
			20018080	446,00	124	20020506OM	508,00	119	20216101AC	713,00	73	20227310OM	275,00	325
			20018201	55,00	396	20020506OR	508,00	119	20216101BM	713,00	73	20227310OR	275,00	325
			20018201AC	85,00	396	20022401	202,00	121	20216101NM	713,00	73	20227810	89,00	322
			20018201BM	85,00	396	20022401AC	312,00	121	20216101OM	1.012,00	73	20227810AC	138,00	322
			20018201NM	85,00	396	20022401BL	312,00	121	20216101OR	1.012,00	73	20227810BM	138,00	322
			20018201OM	120,00	396	20022401BM	312,00	121	20216103	450,00	73	20227810KMB	138,00	322
			20018201OR	120,00	396	20022401NE	312,00	121	20216103AC	698,00	73	20227810NM	138,00	322
			20018301	35,00	397	20022401NM	312,00	121	20216103BM	698,00	73	20227810OM	196,00	322
			20020303	244,00	118	20022401OM	444,00	121	20216103NM	698,00	73	20227810OR	196,00	322
			20020303AC	378,00	118	20022401OR	444,00	121	20216103OM	990,00	73	20228003	621,00	329
			20020303BL	378,00	118	20024501	415,00	406	20216103OR	990,00	73	20228003AC	916,00	329
			20020303BM	378,00	118	20024501AC	518,00	406	20216701	344,00	68	20228003BM	916,00	329
			20020303NE	378,00	118	20024501BM	643,00	406	20216701AC	534,00	68	20228003NM	916,00	329
			20020303NM	378,00	118	20024501KMB	643,00	406	20216701BM	534,00	68	20228003OM	1.263,00	329
			20020303OM	536,00	118	20024501KMB	643,00	406	20216701KMB	534,00	68	20228003OR	1.263,00	329
			20020303OR	536,00	118	20024501NM	643,00	406	20216701NM	534,00	68	20228004	595,00	326
			20020304	244,00	117	20024501OM	912,00	406	20216701OM	758,00	68	20228004AC	868,00	326
			20020304AC	378,00	117	20024501OP	912,00	406	20216701OR	758,00	68	20228004BM	868,00	326
			20020304BL	378,00	117	20024501OPM	912,00	406	20217001	365,00	68	20228004KMB	868,00	326
			20020304BM	378,00	117	20024501OR	912,00	406	20217001AC	566,00	68	20228004NM	868,00	326
			20020304NE	378,00	117	20030021	150,00	120	20217001BM	566,00	68	20228004OM	1.195,00	326
			20020304NM	378,00	117	20030021AC	233,00	120	20217001KMB	566,00	68	20228004OR	1.195,00	326
			20020304OM	536,00	117	20030021BM	233,00	120	20217001NM	566,00	68	20228005	750,00	326
			20020304OR	536,00	117	20030021NM	233,00	120	20217001OM	804,00	68	20228005AC	1.108,00	326
			20020305	278,00	118	20030021OR	330,00	120	20217001OR	804,00	68	20228005BM	1.108,00	326
			20020305AC	431,00	118	20030022	160,00	120	20218221	48,00	395	20228005NM	1.108,00	326
			20020305BL	431,00	118	20030022AC	248,00	120	20218221AC	74,00	395	20228005OM	1.537,00	326
			20020305BM	431,00	118	20030022AC	248,00	120	20218221BM	74,00	395	20228005OR	1.537,00	326
			20020305NE	431,00	118	20030022BM	248,00	120	20218221NM	74,00	395	20228006	1.100,00	331
			20020305NM	431,00	118	20030022NM	248,00	120	20218221OM	106,00	395	20228006AC	1.657,00	331
			20020305OM	612,00	118	20030022OM	352,00	120	20218221OR	106,00	395	20228006BM	1.657,00	331
			20020305OR	612,00	118	20030022OR	352,00	120	20219101	715,00	68	20228006NM	1.657,00	331
			20020306	278,00	117	20044002	232,00	439	20219101AC	1.108,00	68	20228006OM	2.316,00	331
			20020306AC	431,00	117	20044002AC	360,00	439	20219101BM	1.108,00	68	20228006OR	2.316,00	331
			20020306BL	431,00	117	20044002BM	360,00	439	20219101KMB	1.108,00	68	20228007	462,00	333
			20020306BM	431,00	117	20044002NM	360,00	439	20219101NM	1.108,00	68	20228007AC	651,00	333
			20020306NE	431,00	117	20047501	252,00	391	20224501	415,00	406	20228007BM	651,00	333
			20020306NM	431,00	117	20050301	100,00	120	20224501AC	643,00	406	20228007NM	651,00	333
			20020306OM	612,00	117	20050301AC	155,00	120	20224501BM	643,00	406	20228007OM	907,00	333
			20020306OR	612,00	117	20050301BM	155,00	120	20224501NM	643,00	406	20228007OR	907,00	333
			20020501	194,00	119	20050301NM	155,00	120	20224501OM	912,00	406	20228110	116,00	323
			20020501AC	301,00	119	20050301OR	219,00	120	20224501OR	912,00	406	20228110AC	179,00	323
			20020501BL	301,00	119	20050301OM	219,00	120	20225053	705,00	288	20228110BM	179,00	323
			20020501BM	301,00	119	20210301	193,00	63	20225053AC	1.023,00	288	20228110KMB	179,00	323
			20020501NE	301,00	119	20210301AC	299,00	63	20225053BM	1.023,00	288	20228110NM	179,00	323
			20020501NM	301,00	119	20210301BM	299,00	63	20225053KMB	1.023,00	288	20228110OM	254,00	323
			20020501OM	427,00	119	20210301D	216,00	63	20225053NM	1.023,00	288	20228110OR	254,00	323
			20020501OR	427,00	119	20210301KMB	299,00	63	20225053OM	1.399,00	288	20230021	170,00	66
			20020502	215,00	119	20210301NM	299,00	63	20225053OR	1.399,00	288	20230021AC	264,00	66
			20020502AC	334,00	119	20210301OM	425,00	63	20225054	677,00	286	20230021BM	264,00	66
			20020502BL	334,00	119	20210301OR	425,00	63	20225054AC	975,00	286	20230021KMB	264,00	66
			20020502BM	334,00	119	20210302	193,00	63	20225054BM	975,00	286	20230021NM	264,00	66
			20020502NE	334,00	119	20210302D	216,00	63	20225054NM	975,00	286	20230021OM	374,00	66
			20020502NM	334,00	119	20210303	362,00	63	20225054OM	1.331,00	286	20230021OR	374,00	66
			20020502OM	474,00	119	20210303AC	561,00	63	20225054OR	1.331,00	286	20230022	180,00	66
			20020502OR	474,00	119	20210303BM	561,00	63	20225055					

Ref./Rif.	Price		Ref./Rif.	Price		Ref./Rif.	Price		Ref./Rif.	Price		Ref./Rif.	Price	
20230023AC	287,00	67	20340301	179,00	172	20827310	95,00	405	211167010M	508,00	148	21125004BM	849,00	287
20230023BM	287,00	67	20370301	168,00	172	20827810	80,00	405	211167010P	508,00	148	21125004KM	849,00	287
20230023NM	287,00	67	20417701	95,00	199	20828110	90,00	405	211167010PM	508,00	148	21125004KMB	849,00	287
20230023OM	287,00	67	20418001	135,00	199	20830002	85,00	405	211167010R	508,00	148	21125004NM	849,00	287
20230023OR	287,00	67	20418002	375,00	199				21117001	252,00	148	21125004OM	1.153,00	287
20230024	195,00	67	20418005	354,00	200				21117001AC	391,00	148	21125004OP	1.153,00	287
20230024AC	302,00	67	20425001	90,00	202	21018107	102,00	499	21117001BM	391,00	148	21125004OPM	1.153,00	287
20230024BM	302,00	67	20425003	496,00	202	21018107AC	158,00	499	21117001KM	391,00	148	21125004OR	1.153,00	287
20230024NM	302,00	67	20425004	526,00	202	21018107BM	158,00	499	21117001KMB	391,00	148	21125005	785,00	286
20230024OM	429,00	67	20425005	805,00	203	21018107KM	158,00	499	21117001NM	391,00	148	21125005AC	1.147,00	286
20230024OR	429,00	67	20425006	510,00	203	21018107KMB	158,00	499	21117001OM	554,00	148	21125005BM	1.147,00	286
20230031	205,00	65	20427810	63,00	197	21018107NM	158,00	499	21117001OP	554,00	148	21125005KM	1.147,00	286
20230031AC	318,00	65	20428003	337,00	198	21018107OM	224,00	499	21117001OPM	554,00	148	21125005KMB	1.147,00	286
20230031BM	318,00	65	20428004	364,00	197	21018107OP	224,00	499	21117001OR	554,00	148	21125005NM	1.147,00	286
20230031KMB	318,00	65	20428005	603,00	198	21018107OPM	224,00	499	21118221	45,00	395	21125005OM	1.575,00	286
20230031NM	318,00	65	20428006	310,00	198	21018107OR	224,00	499	21118221AC	70,00	395	21125005OP	1.575,00	286
20230031OM	451,00	65	20428110	79,00	197	21110301	111,00	143	21118221BM	70,00	395	21125005OPM	1.575,00	286
20230031OR	451,00	65	20510301	107,00	185	21110301AC	173,00	143	21118221KM	70,00	395	21125005OR	1.575,00	286
20230032	215,00	65	20510301D	130,00	185	21110301BM	173,00	143	21118221KMB	70,00	395	21125006	1.140,00	291
20230032AC	333,00	65	20510303	210,00	185	21110301D	134,00	143	21118221NM	70,00	395	21125006AC	1.696,00	291
20230032BM	333,00	65	20511201	119,00	470	21110301M	173,00	143	21118221OM	99,00	395	21125006BM	1.696,00	291
20230032KMB	333,00	65	20511202	161,00	470	21110301KMB	173,00	143	21118221OP	99,00	395	21125006KM	1.696,00	291
20230032NM	333,00	65	20512001	110,00	186	21110301NM	173,00	143	21118221OPM	99,00	395	21125006KMB	1.696,00	291
20230032OM	473,00	65	20512001D	133,00	186	21110301OM	245,00	143	21118221OR	99,00	395	21125006NM	1.696,00	291
20230032OR	473,00	65	20516101	320,00	191	21110301OP	245,00	143	21120301	233,00	143	21125006OM	2.355,00	291
20230033	220,00	66	20516103	310,00	190	21110301OPM	245,00	143	21120301AC	361,00	143	21125006OP	2.355,00	291
20230033AC	341,00	66	20516701	137,00	187	21110301OR	245,00	143	21120301BM	361,00	143	21125006OPM	2.355,00	291
20230033BM	341,00	66	20517001	158,00	187	21110302	111,00	143	21120301KM	361,00	143	21125006OR	2.355,00	291
20230033NM	341,00	66	20517701	97,00	189	21110302AC	173,00	143	21120301KMB	361,00	143	21125007	445,00	292
20230033OM	484,00	66	20518001	139,00	189	21110302BM	173,00	143	21120301NM	361,00	143	21125007AC	621,00	292
20230033OR	484,00	66	20518002	412,00	190	21110302D	134,00	143	21120301OM	513,00	143	21125007BM	621,00	292
20230034	240,00	66	20518006	418,00	189	21110302KM	173,00	143	21120301OP	513,00	143	21125007KM	621,00	292
20230034AC	372,00	66	20518007	391,00	190	21110302KMB	173,00	143	21120301OPM	513,00	143	21125007KMB	621,00	292
20230034BM	372,00	66	20518301	35,00	397	21110302NM	173,00	143	21120301OR	513,00	143	21125007NM	621,00	292
20230034NM	372,00	66	20518301NM	55,00	397	21110302OM	245,00	143	21120302	233,00	144	21125007OM	828,00	292
20230034OM	528,00	66	20522201	231,00	121	21110302OP	245,00	143	21120302AC	361,00	144	21125007OP	828,00	292
20230034OR	528,00	66	20522201AC	358,00	121	21110302OPM	245,00	143	21120302BM	361,00	144	21125007OPM	828,00	292
20247001	1.660,00	72	20522201BM	358,00	121	21110302OR	245,00	143	21120302KM	361,00	144	21125007OR	828,00	292
20247001AC	1.798,00	72	20522201NM	358,00	121	21112001	114,00	147	21120302KMB	361,00	144	21127810	79,00	323
20247001BM	1.798,00	72	20522301	189,00	121	21112001AC	177,00	147	21120302NM	361,00	144	21127810AC	122,00	323
20247001KMB	1.798,00	72	20522301AC	293,00	121	21112001BM	177,00	147	21120302OM	513,00	144	21127810BM	122,00	323
20247001KM	1.798,00	72	20522301BM	293,00	121	21112001D	138,00	147	21120302OP	513,00	144	21127810KM	122,00	323
20247001NM	1.798,00	72	20522301NM	293,00	121	21112001KM	177,00	147	21120302OPM	513,00	144	21127810KMB	122,00	323
20247001OM	2.552,00	72	20522301OM	416,00	121	21112001KMB	177,00	147	21120302OR	513,00	144	21127810NM	122,00	323
20247001OP	2.552,00	72	20522301OR	416,00	121	21112001NM	177,00	147	21120501	184,00	145	21127810OM	173,00	323
20247001OPM	2.552,00	72	20527810	79,00	323	21112001OM	252,00	147	21120501AC	285,00	145	21127810OP	173,00	323
20247001OR	2.552,00	72	20528003	428,00	330	21112001OP	252,00	147	21120501BM	285,00	145	21127810OPM	173,00	323
20261310	357,00	419	20528004	452,00	328	21112001OPM	252,00	147	21120501KM	285,00	145	21127810OR	173,00	323
20261310AC	553,00	419	20528005	905,00	332	21112001OR	252,00	147	21120501KMB	285,00	145	21128003	506,00	330
20261310BM	553,00	419	20528006	335,00	189	21112002	114,00	147	21120501NM	285,00	145	21128003AC	735,00	330
20261310NM	553,00	419	20528110	100,00	324	21112002AC	177,00	147	21120501OM	404,00	145	21128003BM	735,00	330
20261310OM	785,00	419	20530021	135,00	186	21112002BM	177,00	147	21120501OP	404,00	145	21128003KM	735,00	330
20261310OR	785,00	419	20530022	145,00	186	21112002D	138,00	147	21120501OPM	404,00	145	21128003KMB	735,00	330
20261320	399,00	422	20530031	125,00	185	21112002KM	177,00	147	21120501OR	404,00	145	21128003NM	735,00	330
20261320AC	618,00	422	20530032	135,00	185	21112002KMB	177,00	147	21120501OR	200,00	147	21128003OM	1.007,00	330
20261320BM	618,00	422	20544001	228,00	439	21112002NM	177,00	147	21122401AC	309,00	147	21128003OP	1.007,00	330
20261320NM	618,00	422	20544001AC	353,00	439	21112002OM	252,00	147	21122401BM	309,00	147	21128003OPM	1.007,00	330
20261320OM	878,00	422	20544001BM	353,00	439	21112002OP	252,00	147	21122401KM	309,00	147	21128003OR	1.007,00	330
20261320OR	878,00	422	20544001NM	353,00	439	21112002OPM	252,00	147	21122401KMB	309,00	147	21128004	540,00	327
20285301	660,00	65	20544001OM	502,00	439	21112002OR	252,00	147	21122401NM	309,00	147	21128004AC	787,00	327
20285301AC	1.023,00	65	20548601	250,00	436	21116101	370,00	151	21122401OM	439,00	147	21128004BM	787,00	327
20285301BM	1.023,00	65	20548601AC	388,00	436	21116101AC	574,00	151	21122401OP	439,00	147	21128004KM	787,00	327
20285301KM	1.023,00	65	20548601BM	388,00	436	21116101BM	574,00	151	21122401OPM	439,00	147	21128004KMB	787,00	327
20285301KMB	1.023,00	65	20548601NM	388,00	436	21116101KM	574,00	151	21122401OR	439,00	147	21128004NM	787,00	327
20285301NM	1.023,00	65	20548601OM	550,00	436	21116101KMB	574,00	151	21125001	116,00	284	21128004OM	1.081,00	327
20285301OM	1.452,00	65	20548702	435,00	451	21116101NM	574,00	151	21125001AC	179,00	284	21128004OP	1.081,00	327
20285301OP	1.452,00	65	20548702AC	674,00	451	21116101OM	814,00	151	21125001BM	179,00	284	21128004OPM	1.081,00	327
20285301OPM	1.452,00	65	20548702BM	674,00	451	21116101OP	814,00	151	21125001KM	179,00	284	21128004OR	1.081,00	327
20285301OR	1.452,00	65	20548702NM	674,00	451	21116101OPM	814,00	151	21125001KMB	179,00	284	21128005	731,00	328
20310301	88,00	171	20560301	310,00	419	21116101OR	814,00	151	21125001NM	179,00	284	21128005AC	1.085,00	328
20310301D	111,00	171	20560302	352,00	422	21116103	380,00	151	21125001OM	254,00	284	21128005BM	1.085,00	328
20312001	91,00	173	20718107	160,00	499	21116103AC	589,00	151	21125001OP	254,00	284	21128005KM	1.085,00	328

PRODUCT LIST / ELENCO DEI RIFERIMENTI

Ref./Rif.	Price		Ref./Rif.	Price		Ref./Rif.	Price		Ref./Rif.	Price		Ref./Rif.	Price	
21128006OPM	2.282,00	332	21150301KMB	163,00	146	21552001	16,00	479	21816701	118,00	210	23045302	250,00	447
21128006OR	2.282,00	332	21150301NM	163,00	146	21552002	20,00	479	21817001	139,00	210	23045302NM	388,00	447
21128007	394,00	334	21150301OM	231,00	146	21599002	248,00	247	21819101	300,00	211	23045303	250,00	447
21128007AC	560,00	334	21150301OP	231,00	146	2161030111	97,00	476	21820301	147,00	207	23045303NM	388,00	447
21128007BM	560,00	334	21150301OPM	231,00	146	21610303	60,00	231	21820303	145,00	207	23045402	311,00	446
21128007KM	560,00	334	21150301OR	231,00	146	21610303DA	74,00	231	21826701	98,00	209	23045402NM	434,00	446
21128007KMB	560,00	334	21180301	268,00	143	21610303NM	93,00	231	21827001	118,00	210	23045403	311,00	446
21128007NM	560,00	334	21180301AC	415,00	143	21610310	62,00	231	21827810	63,00	211	23045403NM	434,00	446
21128007OM	758,00	334	21180301BM	415,00	143	21610410	68,00	231	21828003	343,00	212	23048701	330,00	451
21128007OP	758,00	334	21180301KM	415,00	143	2161041011BR1	100,00	476	21828004	370,00	212	23048701OM	726,00	451
21128007OPM	758,00	334	21180301KMB	415,00	143	21612010	63,00	232	21828005	592,00	213	23048701OPM	726,00	451
21128007OR	758,00	334	21180301NM	415,00	143	21612010DA	77,00	232	21828006	340,00	213	23048702	360,00	451
21128110	100,00	324	21180301OM	589,00	143	21612010NM	97,00	232	21828110	79,00	212	23048702NM	558,00	451
21128110AC	155,00	324	21180301OP	589,00	143	21616401	139,00	235	21830010	45,00	521	23048702OM	792,00	451
21128110BM	155,00	324	21180301OPM	589,00	143	21616401NM	215,00	235	21830023	108,00	208	23048702OPM	792,00	451
21128110KM	155,00	324	21180301OR	589,00	143	21616409	153,00	235	21830024	118,00	209	23050301	150,00	447
21128110KMB	155,00	324	21180302	268,00	144	21616409NM	238,00	235	21830801	134,00	208	23050301NM	233,00	447
21128110NM	155,00	324	21180302AC	415,00	144	21616710	89,00	232	21830802	128,00	208	23050301OM	330,00	447
21128110OM	219,00	324	21180302BM	415,00	144	21616710NM	138,00	232	21831221	417,00	211	23050301OPM	330,00	447
21128110OP	219,00	324	21180302KM	415,00	144	21617010	112,00	233	21880301	180,00	208	23050302	60,00	447
21128110OPM	219,00	324	21180302KMB	415,00	144	21617010NM	174,00	233	21899501	255,00	210	23050401	243,00	446
21128110OR	219,00	324	21180302NM	415,00	144	21617701	90,00	235				23050401NM	344,00	446
21130021	140,00	146	21180302OM	589,00	144	21618001	126,00	235				23050401OM	481,00	446
21130021AC	217,00	146	21180302OP	589,00	144	21618221	44,00	396	22010301	85,00	195	23050401OPM	481,00	446
21130021BM	217,00	146	21180302OPM	589,00	144	21619110	289,00	233	22010401	93,00	195	23050402	162,00	446
21130021KM	217,00	146	21180302OR	589,00	144	21619601	249,00	235	22012001	88,00	196	23444005	7,00	518
21130021KMB	217,00	146	21190401	208,00	144	21619601NM	363,00	235	22016701	120,00	196	23461013	6,00	518
21130021NM	217,00	146	21190401AC	322,00	144	21619602	302,00	236	22017001	140,00	196	23461015	6,00	518
21130021OM	308,00	146	21190401BM	322,00	144	21625001	85,00	238	22020401	155,00	195	23461038	6,00	519
21130021OP	308,00	146	21190401KM	322,00	144	21625001NM	130,00	238	22030021	200,00	195	23461050	6,00	518
21130021OPM	308,00	146	21190401KMB	322,00	144	21625004	498,00	238	22030022	210,00	196	23461301	6,00	518
21130021OR	308,00	146	21190401NM	322,00	144	21625004NM	772,00	238				23461303	6,00	518
21130022	150,00	147	21190401OM	457,00	144	21626710	75,00	232				23461305	8,00	518
21130022AC	233,00	147	21190401OP	457,00	144	21627010	98,00	233	23033502	220,00	450	23461380	6,00	519
21130022BM	233,00	147	21190401OPM	457,00	144	21627810	58,00	234	23033502AC	341,00	450	23461501	6,00	518
21130022KM	233,00	147	21190401OR	457,00	144	21628004	344,00	234	23033502BM	341,00	450	23466001	6,00	518
21130022KMB	233,00	147	21190501	218,00	144	21628110	74,00	234	23033502NM	341,00	450	23466203	6,00	518
21130022OM	330,00	147	21190501AC	339,00	144	21631221	389,00	233	23033502OM	484,00	450	23466205	6,00	518
21130022OP	330,00	147	21190501BM	339,00	144	2163200311	164,00	476	23033502OPM	484,00	450	23466905	6,00	519
21130022OPM	330,00	147	21190501KM	339,00	144	21632010	84,00	460	23033503	240,00	450	23466938	6,00	519
21130022OR	330,00	147	21190501KMB	339,00	144	21632020	86,00	460	23033503AC	372,00	450	23467205	6,00	519
21130031	175,00	146	21190501NM	339,00	144	21632030	88,00	460	23033503BM	372,00	450	23467238	6,00	519
21130031AC	271,00	146	21190501OM	480,00	144	21639301	315,00	236	23033503NM	372,00	450	23468301	9,00	519
21130031BM	271,00	146	21190501OP	480,00	144	21639302NM	488,00	236	23033503OM	528,00	450	23468303	9,00	519
21130031KM	271,00	146	21190501OPM	480,00	144	21639502NM	628,00	237	23033503OPM	528,00	450			
21130031KMB	271,00	146	21190501OR	480,00	144	21639521	405,00	237	23043801	340,00	452			
21130031OM	385,00	146	21190601	229,00	145	21642010	98,00	462	23043802	300,00	453	24210201	273,00	43
21130031OP	385,00	146	21190601AC	355,00	145	21644010	83,00	440	23043802AC	465,00	453	24210201AC	423,00	43
21130031OPM	385,00	146	21190601BM	355,00	145	21644020	89,00	440	23043802NM	465,00	453	24210201LM	396,00	43
21130031OR	385,00	146	21190601KM	355,00	145	21644710	78,00	443	23043803	260,00	452	24210201LV	396,00	43
21130032	185,00	146	21190601KMB	355,00	145	21644720	84,00	443	23043803AC	403,00	452	24210201OR	601,00	43
21130032AC	287,00	146	21190601NM	355,00	145	21710301	79,00	523	23043803NM	403,00	452	24210301	215,00	43
21130032BM	287,00	146	21190601OM	504,00	145	21710303	77,00	523	23043804	190,00	453	24210301AC	334,00	43
21130032KM	287,00	146	21190601OP	504,00	145	21710401	85,00	523	23043804NM	295,00	453	24210301LM	312,00	43
21130032KMB	287,00	146	21190601OPM	504,00	145	21712001	80,00	220	23043840	107,00	454	24210301LV	312,00	43
21130032NM	287,00	146	21210001	45,00	472	21712301	175,00	220	23044002	245,00	436	24210301OR	474,00	43
21130032OM	407,00	146	21210301	61,00	471	21716401	182,00	224	23044002AC	380,00	436	24210501	383,00	44
21130032OP	407,00	146	21220001	40,00	472	21716409	227,00	224	23044002BM	380,00	436	24210501AC	594,00	44
21130032OPM	407,00	146	21510303	53,00	243	21716701	103,00	221	23044002NM	380,00	436	24210501LM	556,00	44
21130501	205,00	145	21510303D	63,00	243	21717001	123,00	221	23044002OM	539,00	436	24210501LV	556,00	44
21130501AC	317,00	145	21510303DA	69,00	243	21717419	302,00	224	23044002OPM	539,00	436	24210501OR	843,00	44
21130501BM	317,00	145	21510310	56,00	243	21717701	95,00	223	23044003	220,00	438	24210601	326,00	44
21130501KM	317,00	145	21510410	66,00	243	21718001	136,00	223	23044003AC	341,00	438	24210601AC	505,00	44
21130501KMB	317,00	145	21510410D	72,00	244	21719101	293,00	222	23044003BM	341,00	438	24210601LM	472,00	44
21130501NM	317,00	145	21512010	56,00	244	21720301	144,00	219	23044003NM	341,00	438	24210601LV	472,00	44
21130501OM	450,00	145	21512010D	70,00	244	21720303	142,00	219	23044003OM	484,00	438	24210601OR	716,00	44
21130501OP	450,00	145	21516710	87,00	245	21725001	90,00	214	23044003OPM	484,00	438	24210801	252,00	43
21130501OPM	450,00	145	2151671011	125,00	477	21725003	482,00	215	23044005	125,00	438	24210801AC	391,00	43
21140501	226,00	145	21517010	102,00	245	21725004	512,00	214	23044005AC	194,00	438	24210801LM	365,00	43
21140501AC	350,00	145	21517701	82,00	246	21725005	790,00	215	23044005NM	194,00	438	24210801LV	365,00	43
21140501BM	350,00	145	21518001	118,00	246	21725006	495,00	215	23044006	160,00	437	24210801OR	554,00	43
21140501KM	350,00	145	21518221	42,00	396	21726701	82,00	221	23044006AC	248,00	437	24210901	179,00	43
21140501KMB	350,00	145	21525001	85,00	249	21727001	103,00	221	23044006NM	248,00	437	24210901AC	277,00	43
21140501NM	350,00	145	21525004	435,00	249	21727810	63,00	222	23044007	140,00				

Ref./Rif.	Price	Ref./Rif.	Price	Ref./Rif.	Price	Ref./Rif.	Price	Ref./Rif.	Price					
24212101	284,00	46	24217602LM	1.291,00	47	24222001AC	395,00	45	24284001KMB	76,00	482	26110501OPM	520,00	81
24212101AC	439,00	46	24217602LV	1.291,00	47	24222001LM	370,00	45	24284001LM	71,00	482	26110501OR	520,00	81
24212101LM	411,00	46	24217609	683,00	52	24222001LV	370,00	45	24284001LV	71,00	482	26110502	252,00	81
24212101LV	411,00	46	24217609AC	1.058,00	52	24222001OR	561,00	45	24284001NE	76,00	482	26110502AC	391,00	81
24212101OR	624,00	46	24217609LM	990,00	52	24230601	106,00	45	24284001NM	76,00	482	26110502BM	391,00	81
24212201	186,00	45	24217609LV	990,00	52	24230601AC	164,00	45	24284001OM	108,00	482	26110502KM	391,00	81
24212201AC	288,00	45	24217609OR	1.502,00	52	24230601LM	154,00	45	24284001OP	108,00	482	26110502KMB	391,00	81
24212201LM	269,00	45	24217701	116,00	48	24230601LV	154,00	45	24284001OPM	108,00	482	26110502NM	391,00	81
24212201LV	269,00	45	24217701AC	179,00	48	24230601OR	233,00	45	24284001OR	108,00	482	26110502OP	554,00	81
24212201OR	409,00	45	24217701LM	167,00	48	24231001	230,00	456	24284001RO	76,00	482	26110502OPM	554,00	81
24212202	289,00	46	24217701LV	167,00	48	24231001AC	357,00	456	24284002	46,00	482	26110502OR	554,00	81
24212202AC	448,00	46	24217701OR	254,00	48	24231001LM	334,00	456	24284002AC	71,00	482	26112001	176,00	84
24212202LM	419,00	46	24217703	566,00	49	24231001LV	334,00	456	24284002BL	71,00	482	2612001D	200,00	84
24212202LV	419,00	46	24217703AC	906,00	49	24231001OR	506,00	456	24284002BM	71,00	482	26116701	278,00	85
24212202OR	635,00	46	24217703LM	821,00	49	24233401	400,00	450	24284002KM	71,00	482	26116701AC	431,00	85
24214501	467,00	50	24217703LV	821,00	49	24233401AC	620,00	450	24284002KMB	71,00	482	26116701BM	431,00	85
24214501AC	724,00	50	24218001	179,00	48	24233401LM	580,00	450	24284002LV	66,00	482	26116701KMB	431,00	85
24214501LM	678,00	50	24218001AC	277,00	48	24233401LV	580,00	450	24284002NE	71,00	482	26116701KM	431,00	85
24214501LV	678,00	50	24218001LM	259,00	48	24233401OR	880,00	450	24284002NM	71,00	482	26116701NM	431,00	85
24214501OR	1.028,00	50	24218001LV	259,00	48	24234101	321,00	438	24284002OM	101,00	482	26116701OP	612,00	85
24214601	610,00	50	24218001OR	393,00	48	24234101AC	498,00	438	24284002OP	101,00	482	26116701OPM	612,00	85
24214601AC	945,00	50	24218003	638,00	48	24234101LM	465,00	438	24284002OPM	101,00	482	26116701OR	612,00	85
24214601LM	884,00	50	24218003AC	991,00	48	24234101LV	465,00	438	24284002OR	101,00	482	26116701TAM	431,00	85
24214601LV	884,00	50	24218003LM	925,00	48	24234101OR	706,00	438	24284010	52,00	482	26116701TRO	431,00	85
24214601OR	1.342,00	50	24218003LV	925,00	48	24234201	237,00	456	24284010AC	81,00	482	26117001	299,00	85
24214602	583,00	50	24218003OR	1.480,00	48	24234201AC	367,00	456	24284010AM	81,00	482	26117001AC	464,00	85
24214602AC	903,00	50	24218004	604,00	48	24234201LM	344,00	456	24284010BL	81,00	482	26117001BM	464,00	85
24214602LM	845,00	50	24218004AC	936,00	48	24234201LV	344,00	456	24284010BM	81,00	482	26117001KMB	464,00	85
24214602LV	845,00	50	24218004LM	876,00	48	24234201OR	521,00	456	24284010KM	81,00	482	26117001NM	464,00	85
24214602OR	1.282,00	50	24218004LV	876,00	48	24235201	786,00	54	24284010KMB	81,00	482	26117001OP	658,00	85
24215101	284,00	44	24218004OR	1.399,00	48	24235201AC	1.218,00	54	24284010LM	75,00	482	26117001OPM	658,00	85
24215101AC	439,00	44	24218005	400,00	49	24235201LM	1.140,00	54	24284010LV	75,00	482	26117001TAM	464,00	85
24215101LM	411,00	44	24218005AC	620,00	49	24235201LV	1.140,00	54	24284010OM	114,00	482	26118221	42,00	396
24215101LV	411,00	44	24218005LM	580,00	49	24235201OR	1.729,00	54	24284010OP	114,00	482	26118221AC	65,00	396
24215101OR	624,00	44	24218005LV	580,00	49	24235202AC	1.564,00	54	24284010OPM	114,00	482	26118221BM	65,00	396
24215102	305,00	44	24218005OR	880,00	49	24235202LM	1.463,00	54	24284010OR	79,00	482	26118221KMB	65,00	396
24215102AC	472,00	44	24218006	678,00	49	24235202LV	1.463,00	54	24284010RO	49,00	483	26118221NM	65,00	396
24215102LM	442,00	44	24218006AC	1.051,00	49	24235202OR	2.220,00	54	24284020	76,00	483	26118221OP	92,00	396
24215102LV	442,00	44	24218006LM	984,00	49	24235203	1.021,00	53	24284020AC	76,00	483	26118221OPM	92,00	396
24215102OR	670,00	44	24218006LV	984,00	49	24235203AC	1.583,00	53	24284020AM	76,00	483	26118221OPM	92,00	396
24215501	93,00	496	24218201	71,00	397	24235203LM	1.480,00	53	24284020BL	76,00	483	26118221OR	92,00	396
24215501AC	145,00	496	24218201AC	111,00	397	24235203LV	1.480,00	53	24284020BM	76,00	483	26130701	312,00	80
24215501LM	136,00	496	24218201LM	104,00	397	24235301	1.330,00	54	24284020KM	76,00	483	26130701AC	483,00	80
24215501LV	136,00	496	24218201LV	104,00	397	24235301AC	2.062,00	54	24284020KMB	76,00	483	26130701BM	483,00	80
24215501OR	206,00	496	24218201OR	157,00	397	24235301LM	1.929,00	54	24284020LM	71,00	483	26130701KMB	483,00	80
24215502	93,00	497	24219101	1.003,00	47	24235301LV	1.929,00	54	24284020LV	71,00	483	26130701NM	483,00	80
24215502AC	145,00	497	24219101AC	1.555,00	47	24235301OR	2.926,00	54	24284020NE	76,00	483	26130701OP	686,00	80
24215502LM	136,00	497	24219101LM	1.454,00	47	24244101	210,00	438	24284020OM	107,00	483	26130701OPM	686,00	80
24215502LV	136,00	497	24219101LV	1.454,00	47	24244101AC	326,00	438	24284020OP	107,00	483	26130701OPM	686,00	80
24215502OR	206,00	497	24219401	459,00	51	24244101LM	305,00	438	24284020OPM	107,00	483	26130701OR	686,00	80
24216301	294,00	46	24219401AC	711,00	51	24244101LV	305,00	438	24284020OR	107,00	483	26130701TAM	483,00	80
24216301AC	456,00	46	24219401LM	665,00	51	24244101OR	462,00	438	24287101	154,00	498	26130701TRO	483,00	80
24216301LM	426,00	46	24219401LV	665,00	51	24247601	494,00	58	24287101AC	239,00	498	26130801	341,00	80
24216301LV	426,00	46	24219401OR	1.009,00	51	24247601AC	765,00	58	24287101LM	223,00	498	26130801AC	529,00	80
24216301OR	647,00	46	24219402	648,00	51	24247601LM	716,00	58	24287101LV	223,00	498	26130801BM	529,00	80
24216402	625,00	52	24219402AC	1.004,00	51	24247601LV	716,00	58	24287101OR	223,00	498	26130801KMB	529,00	80
24216402AC	969,00	52	24219402LM	939,00	51	24247602	481,00	57	24287101OR	339,00	498	26130801NM	529,00	80
24216402LM	906,00	52	24219402LV	939,00	51	24247602AC	745,00	57	26130701TRO	483,00	80	26130801OP	751,00	80
24216402LV	906,00	52	24219403	350,00	497	24247602LM	697,00	57	26130801OPM	751,00	80	26130801OR	751,00	80
24216409	488,00	51	24219403AC	543,00	497	24247602LV	697,00	57	26130801TAM	529,00	80	26130801TRO	483,00	80
24216409AC	757,00	51	24219403LM	508,00	497	24250001	88,00	56	26130801TRO	483,00	80	26190301	173,00	79
24216409LM	708,00	51	24219403LV	508,00	497	24250001AC	136,00	56	26190301AC	269,00	79	26190301BM	269,00	79
24216409LV	708,00	51	24219501	867,00	52	24250001LM	127,00	56	26190301BM	269,00	79	26190301OP	381,00	79
24216409OR	1.074,00	51	24219501AC	1.344,00	52	24250001LV	127,00	56	26190301OPM	381,00	79	26190301OR	381,00	79
24216701	305,00	46	24219501LM	1.257,00	52	24250001OR	193,00	56	26190301TAM	269,00	79	26190301TRO	269,00	79
24216701AC	472,00	46	24219501LV	1.257,00	52	24250301	104,00	45	26212001	176,00	84			
24216701LM	442,00	46	24219502	1.039,00	53	24250301AC	156,00	45						
24216701LV	442,00	46	24219502AC	1.610,00	53	24250301LM	146,00	45						
24216701OR	670,00	46	24219502LM	1.507,00	53	24250301LV	146,00	45						
24217001	352,00	46	24219502LV	1.507,00	53	24250301OR	222,00	45						
24217001AC	545,00	46	24219801	964,00	53	24252001	103,00	56						
24217001LM	510,00	46	24219801AC	1.494,00	53	24252001AC	159,00	56						
24217001LV	510,00	46	24219801LM	1.398,00	53	24252001LM	149,00	56						
24217001OR	774,00	46	24219801LV	1.398,00	53	24252001OR	226,00	56						
24217409	541,00	51	24220001	263,00	44	24273201	216,00	383						
24217409AC	838,00	51	24220001AC	407,00	44	24273201AC	335,00	383						

PRODUCT LIST / ELENCO DEI RIFERIMENTI

Ref./Rif.	Price	Ref./Rif.	Price	Ref./Rif.	Price	Ref./Rif.	Price	Ref./Rif.	Price					
26212001D	200,00	84	26227302BM	946,00	335	26230021OPM	389,00	83	26285306	578,00	82	28117001	263,00	134
26215001	450,00	166	26227302KM	946,00	335	26230021OR	389,00	83	26285306AC	895,00	82	28117001AC	407,00	134
26218004	102,00	500	26227302KMB	946,00	335	26230022	187,00	83	26285306BM	895,00	82	28117001NM	407,00	134
26218004AC	158,00	500	26227302NM	946,00	335	26230022AC	290,00	83	26285306KM	895,00	82	28117001OPM	578,00	134
26218004BM	158,00	500	26227302OM	1.304,00	335	26230022BM	290,00	83	26285306KMB	895,00	82	28119101	497,00	135
26218004KM	158,00	500	26227302OP	1.304,00	335	26230022KM	290,00	83	26285306NM	895,00	82	28119101AC	770,00	135
26218004KMB	158,00	500	26227302OPM	1.304,00	335	26230022KMB	290,00	83	26285306OM	1.271,00	82	28119101NM	770,00	135
26218004NM	158,00	500	26227302OR	1.304,00	335	26230022NM	290,00	83	26285306OP	1.271,00	82	28119101OPM	1.093,00	135
26218004OM	224,00	500	26227310	125,00	325	26230022OM	411,00	83	26285306OPM	1.271,00	82	28119701	528,00	135
26218004OP	224,00	500	26227310AC	194,00	325	26230022OP	411,00	83	26285306OR	1.271,00	82	28119701AC	819,00	135
26218004OPM	224,00	500	26227310BM	194,00	325	26230022OPM	411,00	83	26285350	189,00	404	28119701NM	819,00	135
26218004OR	224,00	500	26227310KM	194,00	325	26230022OR	411,00	83	26290301	173,00	79	28119701OPM	1.162,00	135
26222402	221,00	84	26227310KMB	194,00	325	26230031	215,00	83	26290301AC	269,00	79	28120301	236,00	132
26222402AC	342,00	84	26227310NM	194,00	325	26230031AC	333,00	83	26290301BM	269,00	79	28120301AC	366,00	132
26222402BM	342,00	84	26227310OM	275,00	325	26230031BM	333,00	83	26290301D	196,00	79	28120301NM	366,00	132
26222402KM	342,00	84	26227310OP	275,00	325	26230031KM	333,00	83	26290301KMB	269,00	79	28120301OPM	520,00	132
26222402KMB	342,00	84	26227310OPM	275,00	325	26230031KMB	333,00	83	26290301KMB	269,00	79	28125001	116,00	285
26222402NM	342,00	84	26227310OR	275,00	325	26230031NM	333,00	83	26290301NM	269,00	79	28125001AC	179,00	285
26222402OM	485,00	84	26227810	89,00	322	26230031OM	473,00	83	26290301OPM	381,00	79	28125001NM	179,00	285
26222402OP	485,00	84	26227810AC	138,00	322	26230031OP	473,00	83	26290301OP	381,00	79	28125001OPM	254,00	285
26222402OPM	485,00	84	26227810BM	138,00	322	26230031OPM	473,00	83	26290301OPM	381,00	79	28125003	538,00	290
26222402OR	485,00	84	26227810KM	138,00	322	26230031OR	473,00	83	26290301OR	381,00	79	28125003AC	766,00	290
26222402TAM	342,00	84	26227810KMB	138,00	322	26230032	225,00	83	26290301TAM	269,00	79	28125003NM	766,00	290
26222402TRO	342,00	84	26227810NM	138,00	322	26230032AC	349,00	83	26290301TRO	269,00	79	28125004	566,00	288
26225001	137,00	285	26227810OM	196,00	322	26230032BM	349,00	83	26290401	242,00	81	28125004AC	806,00	288
26225001AC	212,00	285	26227810OP	196,00	322	26230032KM	349,00	83	26290401AC	374,00	81	28125004NM	806,00	288
26225001BM	212,00	285	26227810OPM	196,00	322	26230032KMB	349,00	83	26290401BM	374,00	81	28125004OPM	1.092,00	288
26225001KM	212,00	285	26227810OR	196,00	322	26230032NM	349,00	83	26290401KM	374,00	81	28125005	1.145,00	291
26225001KMB	212,00	285	26228003	473,00	329	26230032OM	495,00	83	26290401KMB	374,00	81	28125005AC	1.706,00	291
26225001NM	212,00	285	26228003AC	675,00	329	26230032OP	495,00	83	26290401NM	374,00	81	28125005NM	1.706,00	291
26225001OM	300,00	285	26228003BM	675,00	329	26230032OPM	495,00	83	26290401OM	531,00	81	28125005OPM	2.369,00	291
26225001OP	300,00	285	26228003KM	675,00	329	26230032OR	450,00	83	26290401OP	531,00	81	28125006	450,00	293
26225001OPM	300,00	285	26228003KMB	675,00	329	26230701	312,00	79	26290401OPM	531,00	81	28125006AC	633,00	293
26225001OR	300,00	285	26228003NM	675,00	329	26230701AC	483,00	79	26290401OR	531,00	81	28125006NM	633,00	293
26225003	558,00	289	26228003OM	924,00	329	26230701BM	483,00	79	26290401TAM	374,00	81	28127301	1.104,00	335
26225003AC	797,00	289	26228003OP	924,00	329	26230701KM	483,00	79	26290401TRO	374,00	81	28127301AC	1.660,00	335
26225003BM	797,00	289	26228003OPM	924,00	329	26230701KMB	483,00	79	26290402	231,00	80	28127301NM	1.660,00	335
26225003KM	797,00	289	26228003OR	924,00	329	26230701NM	483,00	79	26290402AC	358,00	80	28127301OPM	2.318,00	335
26225003KMB	797,00	289	26228004	495,00	326	26230701OM	686,00	79	26290402BM	358,00	80	28127302	1.180,00	336
26225003NM	797,00	289	26228004AC	712,00	326	26230701OP	686,00	79	26290402KM	358,00	80	28127302AC	1.780,00	336
26225003OM	1.078,00	289	26228004BM	712,00	326	26230701OPM	686,00	79	26290402KMB	358,00	80	28127302NM	1.780,00	336
26225003OP	1.078,00	289	26228004KM	712,00	326	26230701OR	686,00	79	26290402NM	358,00	80	28127302OPM	2.486,00	336
26225003OPM	1.078,00	289	26228004KMB	712,00	326	26230701TAM	483,00	79	26290402OM	508,00	80	28127310	109,00	325
26225003OR	1.078,00	289	26228004NM	712,00	326	26230701TRO	483,00	79	26290402OP	508,00	80	28127310AC	169,00	325
26225004	585,00	287	26228004OM	977,00	326	26230801	341,00	79	26290402OPM	508,00	80	28127310NM	169,00	325
26225004AC	837,00	287	26228004OP	977,00	326	26230801AC	529,00	79	26290402OR	508,00	80	28127310OPM	240,00	325
26225004BM	837,00	287	26228004OPM	977,00	326	26230801BM	529,00	79	26290402TAM	358,00	80	28127810	79,00	322
26225004KM	837,00	287	26228004OR	977,00	326	26230801KMB	529,00	79	26290402TRO	358,00	80	28127810AC	122,00	322
26225004KMB	837,00	287	26228005	1.026,00	331	26230801KMB	529,00	79	26290403	221,00	80	28127810NM	122,00	322
26225004NM	837,00	287	26228005AC	1.546,00	331	26230801NM	529,00	79	26290403AC	342,00	80	28127810OPM	173,00	322
26225004OM	1.136,00	287	26228005BM	1.546,00	331	26230801OM	751,00	79	26290403BM	342,00	80	28128004	474,00	327
26225004OP	1.136,00	287	26228005KM	1.546,00	331	26230801OP	751,00	79	26290403KM	342,00	80	28128004AC	691,00	327
26225004OPM	1.136,00	287	26228005KMB	1.546,00	331	26230801OPM	751,00	79	26290403KMB	342,00	80	28128004NM	691,00	327
26225004OR	1.136,00	287	26228005NM	1.546,00	331	26230801OR	751,00	79	26290403NM	342,00	80	28128004OPM	947,00	327
26225005	1.164,00	291	26228005OM	2.160,00	331	26230801TAM	529,00	79	26290403OM	485,00	80	28128110	100,00	324
26225005AC	1.737,00	291	26228005OP	2.160,00	331	26230801TRO	529,00	79	26290403OP	485,00	80	28128110AC	155,00	324
26225005BM	1.737,00	291	26228005OPM	2.160,00	331	26247005	1.103,00	89	26290403OPM	485,00	80	28128110NM	155,00	324
26225005KM	1.737,00	291	26228005OR	2.160,00	331	26247005AC	1.709,00	89	26290403OR	485,00	80	28128110OPM	219,00	324
26225005KMB	1.737,00	291	26228006	381,00	333	26247005BM	1.709,00	89	26290403TAM	342,00	80	28130021	145,00	133
26225005NM	1.737,00	291	26228006AC	545,00	333	26247005KM	1.709,00	89	26290403TRO	342,00	80	28130021AC	225,00	133
26225005OM	2.412,00	291	26228006BM	545,00	333	26247005KMB	1.709,00	89				28130021NM	225,00	133
26225005OP	2.412,00	291	26228006KM	545,00	333	26247005NM	1.709,00	89				28130021OPM	352,00	133
26225005OPM	2.412,00	291	26228006KMB	545,00	333	26247005OM	2.426,00	89	28110301	121,00	131	28130022	155,00	133
26225005OR	2.412,00	291	26228006NM	545,00	333	26247005OP	2.426,00	89	28110301AC	187,00	131	28130022AC	240,00	133
26225006	470,00	293	26228006OP	740,00	333	26247005OPM	2.426,00	89	28110301NM	187,00	131	28130022NM	240,00	133
26225006AC	650,00	293	26228006OP	740,00	333	26247005OR	2.426,00	89	28110301OPM	266,00	131	28130022OPM	341,00	133
26225006BM	650,00	293	26228006OPM	740,00	333	26247006	1.103,00	89	28110401	129,00	131	28130023	185,00	133
26225006KM	650,00	293	26228006OR	740,00	333	26247006AC	1.709,00	89	28110401AC	200,00	131	28130023AC	287,00	133
26225006KMB	650,00	293	26228110	116,00	324	26247006BM	1.709,00	89	28110401NM	200,00	131	28130023NM	287,00	133
26225006NM	650,00	293	26228110AC	179,00	324	26247006KM	1.709,00	89	28110401OPM	284,00	131	28130023OPM	407,00	133
26225006OM	850,00	293	26228110BM	179,00	324	26247006KMB	1.709,00	89	28110402	133,00	132	28130024	195,00	133
26225006OP	850,00	293	26228110KM	179,00	324	26247006NM	1.709,00	89	28110402AC	207,00	132	28130024AC	302,	

Ref./Rif.	Price		Ref./Rif.	Price		Ref./Rif.	Price		Ref./Rif.	Price		Ref./Rif.	Price	
28184701	236,00	131	29933701OR	185,00	368	29963203OR	792,00	361	29990308BM	1.263,00	359	30725305OPM	3.083,00	278
28184701AC	366,00	131	29933702	60,00	369	29963206	135,00	363	29990308NM	1.263,00	359	30725305OR	3.083,00	278
28184701NM	366,00	131	29933702AC	93,00	369	29963901	10,00	394	29990308OM	1.793,00	359	30725306	1.477,00	278
28184701OPM	520,00	131	29933702LM	87,00	369	29963902	85,00	367	29990308OP	1.793,00	359	30725306AC	2.290,00	278
28190301	125,00	132	29933702LV	87,00	369	29963902AC	132,00	367	29990308OPM	1.793,00	359	30725306KMB	2.290,00	278
28190301AC	194,00	132	29933702OR	132,00	369	29963902BM	132,00	367	29990308OR	1.793,00	359	30725306NM	2.290,00	278
28190301NM	194,00	132	29933703	268,00	364	29963902KMB	132,00	367	29995001	38,00	174	30725306OM	3.250,00	278
28190301OPM	275,00	132	29933703AC	415,00	364	29963902NM	132,00	367	29995301	790,00	355	30725306OP	3.250,00	278
28310301	236,00	35	29933703LM	389,00	364	29963902OM	187,00	367	29995301AC	1.225,00	355	30725306OPM	3.250,00	278
28310301AC	366,00	35	29933703LV	389,00	364	29963902OP	187,00	367	29995301BM	1.225,00	355	30725306OR	3.250,00	278
28310301NM	366,00	35	29933703OR	590,00	364	29963902OPM	187,00	367	29995301NM	1.225,00	355	30725401	660,00	275
28310301OM	520,00	35	299392134	10,00	521	29963902OR	187,00	367	29995301OM	1.738,00	355	30725401AC	1.023,00	275
28310301OPM	520,00	35	29943801	54,00	364	29963910	40,00	394	29995301OR	1.738,00	355	30725401KMB	1.023,00	275
28310501	315,00	35	29944601	55,00	497	29963910AC	62,00	394	29995501	1.135,00	354	30725401NM	1.023,00	275
28310501AC	488,00	35	29945302	62,00	449	29963910LM	58,00	394	29995501AC	1.759,00	354	30725401OM	1.452,00	275
28310501NM	488,00	35	29945303	120,00	449	29963910LV	58,00	394	29995501BM	1.759,00	354	30725401OP	1.452,00	275
28310501OM	693,00	35	29945304	53,00	449	29963910OR	88,00	394	29995501NM	1.759,00	354	30725401OPM	1.452,00	275
28310501OPM	693,00	35	29951501	63,00	399	29963928	7,00	394	29995501OM	2.497,00	354	30725401OR	1.452,00	275
28312001	239,00	36	29951502	56,00	400	29966310	5,00	518	29995501OR	2.497,00	354	30725405	1.842,00	279
28312001AC	371,00	36	29951503	55,00	400	29974802	30,00	374	29995801	2.440,00	356	30725405AC	2.854,00	279
28312001NM	371,00	36	29951504	693,00	398	29974901	33,00	373	29996201	1.390,00	354	30725405KMB	2.854,00	279
28312001OM	527,00	36	29951504AC	1.074,00	398	29974904	45,00	372	29997001	1.440,00	354	30725405NM	2.854,00	279
28312001OPM	527,00	36	29951504BM	1.074,00	398	29974905	35,00	373	29997001AC	2.232,00	354	30725405OM	4.051,00	279
28316301	336,00	36	29951504NM	1.074,00	398	29974906	39,00	372	29997001BM	2.232,00	354	30725405OP	4.051,00	279
28316301AC	521,00	36	29951504OM	1.525,00	398	29985001	36,00	521	29997001NM	2.232,00	354	30725405OPM	4.051,00	279
28316301NM	521,00	36	29951504OR	1.525,00	398	29985002	40,00	521	29997001OM	3.168,00	354	30725405OR	4.051,00	279
28316301OPM	739,00	36	29951505	709,00	398	29985003	50,00	521	29997001OR	3.168,00	354	30725406	1.918,00	279
28317601	404,00	36	29951505AC	1.099,00	398	29987001	114,00	498	29997101	1.540,00	354	30725406AC	2.972,00	279
28317601AC	627,00	36	29951505BM	1.099,00	398	29987001AC	177,00	498	29997201	2.440,00	354	30725406KMB	2.972,00	279
28317601NM	627,00	36	29951505NM	1.099,00	398	29987001NM	177,00	498				30725406NM	2.972,00	279
28317601OM	889,00	36	29951505OM	1.559,00	398	29987001OM	251,00	498	30			30725406OP	4.219,00	279
28317601OPM	889,00	36	29951505OR	1.559,00	398	29987001OPM	251,00	498	30725201	560,00	274	30725406OPM	4.219,00	279
28319401	578,00	37	29951506	420,00	398	29987002	126,00	497	30725201AC	868,00	274	30725406OPM	4.219,00	279
28319401AC	895,00	37	29951507	436,00	398	29989601	19,00	521	30725201KMB	868,00	274	30725406OR	4.219,00	279
28319401NM	895,00	37	29951607	920,00	355	29989602	17,00	521	30725201NM	868,00	274	30735201	540,00	274
28319401OM	1.271,00	37	29951607AC	1.426,00	355	29989603	21,00	521	30725201OM	1.232,00	274	30735201AC	837,00	274
28319401OPM	1.271,00	37	29951607BM	1.426,00	355	29990301	755,00	358	30725201OP	1.232,00	274	30735201KMB	837,00	274
28320301	252,00	35	29951607NM	1.426,00	355	29990301AC	1.170,00	358	30725201OPM	1.232,00	274	30735201NM	837,00	274
28320301AC	391,00	35	29951607OM	2.024,00	355	29990301BM	1.170,00	358	30725201OR	1.232,00	274	30735201OM	1.188,00	274
28320301NM	391,00	35	29951607OR	2.024,00	355	29990301NM	1.170,00	358	30725204	782,00	276	30735201OP	1.188,00	274
28320301OM	554,00	35	29952505	16,00	495	29990301OM	1.661,00	358	30725204AC	1.210,00	276	30735201OPM	1.188,00	274
28320301OPM	554,00	35	29953202	295,00	360	29990301OPM	1.661,00	358	30725204KMB	1.210,00	276	30735201OR	1.188,00	274
28325001	179,00	284	29955303	31,00	520	29990301OR	1.661,00	358	30725204NM	1.210,00	276	30735204	811,00	276
28325001AC	277,00	284	29955304	31,00	520	29990302	555,00	359	30725204OM	1.718,00	276	30735204AC	1.163,00	276
28325001NM	277,00	284	29955306	13,00	520	29990302AC	860,00	359	30725204OP	1.718,00	276	30735204KMB	1.163,00	276
28325001OM	393,00	284	29961001	5,00	518	29990302BM	860,00	359	30725204OPM	1.718,00	276	30735204NM	1.163,00	276
28325001OPM	393,00	284	29961002	6,00	518	29990302NM	860,00	359	30725204OR	1.718,00	276	30735204OM	1.651,00	276
28325002	625,00	285	29961005	6,00	518	29990302OM	1.221,00	359	30725205	1.116,00	276	30735204OP	1.651,00	276
28325002AC	899,00	285	29961006	7,00	518	29990302OPM	1.221,00	359	30725205AC	1.730,00	276	30735204OPM	1.651,00	276
28325002NM	899,00	285	29963105	28,00	375	29990302OR	1.221,00	359	30725205KMB	1.730,00	276	30735204OR	1.651,00	276
28325002OM	1.224,00	285	29963106	25,00	374	29990303	455,00	359	30725205NM	1.730,00	276	30735206	1.329,00	277
28325002OPM	1.224,00	285	29963108	21,00	371	29990303AC	705,00	359	30725205OM	2.456,00	276	30735206AC	1.966,00	277
28330001	289,00	35	29963109	58,00	374	29990303BM	705,00	359	30725205OP	2.456,00	276	30735206KMB	1.966,00	277
28330001AC	448,00	35	29963109AC	90,00	374	29990303KM	705,00	359	30725205OPM	2.456,00	276	30735206NM	1.966,00	277
28330001NM	448,00	35	29963109LM	84,00	374	29990303KMB	705,00	359	30725205OR	2.456,00	276	30735206OM	2.790,00	277
28330001OM	635,00	35	29963109LV	84,00	374	29990303NM	705,00	359	30725206	1.315,00	277	30735206OP	2.790,00	277
28330001OPM	635,00	35	29963109OR	145,00	374	29990303OM	1.001,00	359	30725206AC	1.855,00	277	30735206OPM	2.790,00	277
28330002	299,00	36	29963110	16,00	375	29990303OP	1.001,00	359	30725206KMB	1.855,00	277	30735206OR	2.790,00	277
28330002AC	464,00	36	29963111	26,00	373	29990303OPM	1.001,00	359	30725206NM	1.855,00	277	30735301	640,00	274
28330002NM	464,00	36	29963112	41,00	372	29990303OR	1.001,00	359	30725206OM	2.895,00	277	30735301AC	992,00	274
28330002OM	658,00	36	29963112AC	64,00	372	29990304	450,00	360	30725206OP	2.895,00	277	30735301KMB	992,00	274
28330002OPM	658,00	36	29963112BM	64,00	372	29990304AC	698,00	360	30725206OPM	2.895,00	277	30735301NM	992,00	274
28380301	294,00	35	29963112KM	64,00	372	29990304BM	698,00	360	30725206OR	2.895,00	277	30735301OM	1.408,00	274
28380301AC	456,00	35	29963112KMB	64,00	372	29990304KMB	698,00	360	30725207	1.197,00	278	30735301OP	1.408,00	274
28380301NM	456,00	35	29963112NM	64,00	372	29990304NM	698,00	360	30725207AC	1.855,00	278	30735301OPM	1.408,00	274
28380301OM	647,00	35	29963112OM	90,00	372	29990304OM	990,00	360	30725207KMB	1.855,00	278	30735301OR	1.408,00	274
28380301OPM	647,00	35	29963112OP	90,00	372	29990304OPM	990,00	360	30725207NM	1.855,00	278	30735401	640,00	275
			29963112OPM	90,00	372	29990304OR	990,00	360	30725207OM	2.633,00	278	30735401AC	992,00	275
			29963112OR	90,00	372	29990306	515,00	359	30725207OP	2.633,00	278	30735401KMB	992,00	275
			29963113	43,00	372	29990306AC	798,00	359	30725207OPM	2.633,00	278	30735401NM	992,00	275
			29963113AC	67,00	372	29990306BM	798,00	359	30725207OR	2.633,00	278	30735401OM	1.408,00	275
			29963113BM	67,00	372	29990306NM	798,00	359	307					

PRODUCT LIST / ELENCO DEI RIFERIMENTI

Ref./Rif.	Price		Ref./Rif.	Price		Ref./Rif.	Price	
39210320	515,00	421	9134591	40,00	519	913480810	19,00	370
39210390	254,00	424	9134592	40,00	519	913481810	26,00	369
39210391	204,00	424	9134609	24,00	377	9134828	18,00	378
39210397	250,00	424	913460910	21,00	377	9134830051	82,00	378
39210399	300,00	424	913460912	23,00	377	9134830053	82,00	378
39274101	310,00	425	913460912AC	35,00	377	9134830054	164,00	378
39274101NM	480,00	425	913460912BM	35,00	377	913483005LM	82,00	378
39274102	315,00	425	913460912KM	35,00	377	913483080	20,00	378
39274201	202,00	426	913460912KMB	35,00	377	913484005	4,00	520
39274201AC	202,00	426	913460912NM	35,00	377	9134840061	9,00	520
39274201BL	202,00	426	913460912OM	51,00	377	913484007	9,00	520
49			913460912OP	51,00	377	913484016	11,00	520
49286299	1.040,00	268	913460912OPM	51,00	377	913484026	16,00	520
49286398	1.113,00	269	913460912OR	51,00	377	913484057	25,00	520
49286399	1.113,00	269	913460915	23,00	377	9134841	10,00	395
49286499	1.187,00	269	913460915AC	35,00	377	9134849	31,00	519
49288299	1.040,00	268	913460915BM	35,00	377	9134867	33,00	378
49288398	1.113,00	269	913460915KM	35,00	377	9134872	35,00	521
49288399	1.113,00	269	913460915KMB	35,00	377	9134880	28,00	519
49288499	1.187,00	269	913460915NM	35,00	377	9134881	33,00	379
50			913460915OM	51,00	377	9134882	7,00	521
50643703	646,00	452	913460915OP	51,00	377	9134887	35,00	379
50648603	651,00	436	913460915OPM	51,00	377	9134890	11,00	521
50716703	485,00	104	913460915OR	51,00	377	9134891	6,00	521
5071700203	518,00	104	913460920	24,00	377	9134893	3,00	521
50783903	48,00	394	9134609AC	36,00	377	9134895	3,00	521
52			9134609BM	36,00	377	9134896	3,00	521
5246360951	113,00	412	9134609KM	36,00	377	9134897	3,00	521
53			9134609KMB	36,00	377	9134898	3,00	521
53049603	471,00	436	9134609NM	36,00	377	9134915	36,00	400
56			9134609OM	52,00	377	916110348	36,00	488
56243703	415,00	453	9134609OP	52,00	377	9161515	129,00	399
56244003	310,00	439	9134609OPM	52,00	377	916184010	20,00	520
91			9134609OR	52,00	377	916184060	28,00	488
9106006	9,00	518	9134615	29,00	400	916218005	31,00	520
910618020	31,00	520	9134630	15,00	378	9162292	15,00	520
910719005	40,00	519	913463250	18,00	494	9174441	30,00	519
9107515	134,00	399	913463320	15,00	494	919260634	11,00	520
9107672	14,00	518	913463320AC	23,00	494	919416401	3,00	521
913010334	7,00	521	913463320BM	23,00	494	9194283	46,00	519
9130190	40,00	519	913463320KM	23,00	494	9194552	120,00	519
913043810	36,00	519	913463320KMB	23,00	494	92		
913049310	35,00	519	913463320LM	22,00	494	9262503	7,00	518
913214591	120,00	519	913463320LV	22,00	494	93		
9133317	7,00	519	913463320NM	23,00	494	932010331	3,00	521
913331703	10,00	521	913463320OM	52,00	494	95		
9133317031	4,00	521	913463320OP	52,00	494	953044052	7,00	521
913400831	8,00	521	913463320OPM	52,00	494	9530440521	2,00	521
9134008311	3,00	521	913463320OR	52,00	494	953331550	8,00	521
9134011	45,00	477	913463330	12,00	494	9533315501	2,00	521
913412380	31,00	371	9134665	7,00	518	953331750	7,00	521
913414580	43,00	498	9134666	7,00	518	9533317501	2,00	521
9134235	46,00	519	9134668	6,00	518	9534294501	2,00	521
9134250	13,00	520	9134672	6,00	518	96		
9134256	14,00	520	9134672501	13,00	518	963033331	4,00	520
913427210	15,00	520	9134673	6,00	518	966110301	9,00	520
913427220	15,00	520	9134673501	13,00	518			
913427510	25,00	520	9134673503	13,00	518			
9134282	15,00	520	9134674	6,00	518			
9134283	7,00	520	9134677	7,00	518			
9134284	8,00	520	9134681	8,00	518			
9134286	8,00	520	91346815	8,00	518			
9134288	40,00	519	91346816	6,00	518			
9134290	40,00	519	9134682	9,00	518			
9134292	15,00	520	91346825	8,00	518			
9134293	15,00	520	91346826	6,00	518			
9134294	12,00	520	9134683	11,00	519			
9134296	17,00	520	9134712	29,00	379			
9134314	20,00	519	9134725	12,00	375			
9134315	25,00	519	9134731	33,00	379			
9134316	30,00	519	9134731051	82,00	379			
9134319	35,00	519	913473810	36,00	370			
9134415	45,00	400	913474410	6,00	501			
9134441	30,00	519	913474420	6,00	501			
9134450	20,00	376	913474430	9,00	501			
9134481	70,00	519	9134745051	58,00	491			
9134515	60,00	399	9134746051	46,00	488			
9134525	16,00	495	9134779	10,00	502			
9134525NM	25,00	495	9134780	14,00	502			
9134577	7,00	518	9134781	6,00	501			
			9134781	6,00	501			
			9134784	8,00	502			
			9134786	12,00	503			
			9134787	13,00	502			
			9134788	12,00	502			
			9134803	9,00	520			
			9134806	8,00	520			

General terms of sale

Prices

Prices do not include VAT and goods will be at your service in our warehouse.

Prices from price list and any appendix that we publish, must be considered "recommended sale prices for end user before taxes".

Prices are subject to variations depending on market circumstances, raw material, labour force, taxes..., and the invoices will be issued based on prices valid on the shipment day.

Orders

Orders will be considered conditional and, therefore, subject to our consideration.

Design

Our models could be changed as a result of design requirements, with no prior notice, always to benefit the product.

The photographic documentation and/or technical design reproduced on the lists, catalogues, leaflets and another publicity media have just an indicative value, then the customer can not resort to them in case of possible claims for disagreement or differences on supplied products. The claims about nonconformity of products supplied must be done, as maximum, 15 days after to receive the merchandise.

Delivery time

Our delivery time is always rough and we do not take responsibility for the troubles than the delay may cause.

Tres Warranty

TRES COMERCIAL SL warrants all the products commercialised under the TRES brand against any possible structural, material or manufacturing defects, for 3 years, starting from the date of purchase by the end customer.

In addition, TRES COMERCIAL SL provides a Commercial Warranty of a further 2 years (**5-year Warranty in total**), with the exception of:

- Coatings of special finishes (any other than chrome).
- Electronic tapware other than the Shower Technology product.
- Shower columns, timed cartridges.
- Complements and accessories (shower hoses, shower controls, shower heads, supports, gate valves, etc.)
- Consumables (filters, seals, aerators, etc.)

This warranty does not modify the rights granted by the local legislation to the end customer before the marketer of the product and before the manufacturer if the product has been acquired from an official distributor.

Prerequisites of the Warranty

To make a warranty claim, a purchase receipt which clearly identifies the date of purchase and the authorised distributor must be presented.

To exercise a warranty claim, the product must have been installed correctly, used in accordance with what may be expected of that product, and have been cleaned and maintained in accordance with the instructions in the manual.

Services within the term of the Warranty

TRES COMERCIAL SL is entitled to decide on the management to carry out, depending on the type of product. This may be: repair by an Official Technical Service; the supply of a replacement part for repair; repair in TRES COMERCIAL SL's facilities; or replacement with the same, or, if the product has been discontinued, a similar product.

Conditions and exclusions

TRES COMERCIAL SL shall be exempt from whatsoever liability:

- If the product has not been installed, maintained and cleaned in accordance with its instructions, enclosed with each product and accessible at www.tresgriferia.com
- If the product has not been used in the manner that may be expected for the product type.
- If non-original parts have been mounted or if there is evidence of undue tampering.
- If the defects result from transport and/or installation.
- If the aspects claimed for are wear parts and this wear is normal for the use that has taken place.

- If the defect has been caused by aggressive external agents (chemicals, corrosive cleaning products, installation in an aggressive environment, excess limescale, ice...)
- If the defect has been caused by environmental circumstances (variations in pressure, extreme temperatures...)
- In the event of a missing component, if said component has not been claimed within a time limit of 30 days from date of purchase.

Limits of the Warranty

Any repair, replacement or any service provision on the affected product does not have the effect of extending this Commercial Warranty.

For this Warranty to be valid, the defect, in each case, must be accepted by our technical department. Should the product analysed not present any defect covered by this Warranty, the following charges shall apply for Technical Service:

- €12 (including VAT) plus transport costs in the case of analysis of the defect at TRES COMERCIAL SL's facilities.
- Official Technical Service rate (available to customers through the Sales dpt.) in the case of service by the Technical Service at the site of installation.

The Commercial Warranty only covers the repair or replacement of material free of charge for the customer. Under no circumstances shall we be liable for damages caused either directly or indirectly by the defect of said material.

Payment

The invoices amount, unless special agreements must be paid by bank draft as maximum 30 days invoice date.

For upper payment terms will be charged financing.

In case that exist unpaid debt, we reserve the right to cancel the orders in process.

Right of ownership

TRES COMERCIAL SL reserve the right of ownership of all products supplied to the customer, up to receive the complete invoice payment.

VERY IMPORTANT

Return of goods

TRES COMERCIAL SL will not accept any return of goods without our agent has accepted it before and informed us.

- 1) TRES COMERCIAL SL does not accept any devolution without previous acceptance (the goods will be returned to the sender)
- 2) TRES COMERCIAL SL does not accept any return of good if it could be repair with original spare parts
- 3) TRES COMERCIAL SL does not accept any product devolution out of guarantee.
- 4) Nevertheless, in case of receiving any goods in perfect conditions, the merchandise undergoes the following depreciation on invoice:

- If it is from the same year: *-15% depreciation*
- If it is previous two years: *-30% depreciation*
- If it is previous three years: *-60% depreciation*

The merchandise' shipment must be done at carriage paid by the customer.

Condizioni generali di vendita

Prezzi

I prezzi di questo listino e qualsiasi annesso che pubblicheremo dovranno considerarsi prezzi di vendita raccomandati per il cliente finale prima delle imposte.

I prezzi sono soggetti a qualsiasi variazione tenendo conto delle circostanze di mercato, materie prime, mano d'opera, imposte, etc, e si fattureranno secondo le condizioni al momento della spedizione.

Ordini

Si considereranno condizionali e soggetti portando alle nostre valutazioni.

Design

I nostri modelli potranno subire modifiche legate alle esigenze di design, senza avviso previo, sempre e comunque a beneficio dell'articolo stesso.

La documentazione fotografica e/o il design tecnico riprodotto nel listino, catalogo, foglietti ed altri strumenti pubblicitari hanno un valore indicativo, perciò il cliente non potrà in nessun caso rifarsi ad essi nel caso di reclami a causa di differenze con i prodotti somministrati. Le reclamazioni dovranno realizzarsi come massimo, nei quindici giorni seguenti alla consegna della merce nel suo luogo di destinazione.

Termine di consegna

I nostri termini di consegna non sono vincolanti e non ci facciamo carico di eventuali ritardi e sue conseguenze.

Garanzia Tres

TRES COMERCIAL SL garantisce tutti i prodotti commercializzati con il marchio TRES contro eventuali difetti strutturali, di materiale o di fabbricazione per 3 anni dalla data di acquisto da parte del consumatore.

TRES COMERCIAL SL offre, inoltre, una Garanzia commerciale di 2 anni supplementari (**Garanzia di 5 anni in totale**), ad eccezione di:

- Rivestimenti con finiture speciali (diversi dalla finitura cromata).
- Rubinetti elettronici diversi dal prodotto Shower Technology.
- Colonne doccia, cartucce temporizzate.
- Complementi e accessori (tubi, comandi della doccia, soffioni, supporti, valvole di intercettazione, ecc.)
- Materiali di consumo (filtri, guarnizioni, aeratori, ecc.).

Questa garanzia non modifica i diritti che la normativa locale concede al consumatore nei confronti del rivenditore del prodotto e del fabbricante nel caso in cui sia stato acquistato da un distributore ufficiale.

Prerequisiti della Garanzia

Per effettuare la richiesta di garanzia, presentare lo scontrino che indichi chiaramente la data di acquisto e il distributore autorizzato.

Per poter usufruire della garanzia, il prodotto deve essere stato installato correttamente, l'uso deve essere conforme a quanto previsto e la pulizia e la manutenzione devono essere state effettuate secondo le istruzioni riportate nel manuale.

Servizi nel periodo di Garanzia

TRES COMERCIAL SL ha la facoltà di decidere la procedura da eseguire, a seconda del tipo di prodotto, tra la riparazione da parte di un Servizio tecnico ufficiale, la fornitura di un pezzo di ricambio per la riparazione, la riparazione presso gli stabilimenti di TRES COMERCIAL SL o lo scambio con un prodotto uguale o simile nel caso in cui sia fuori produzione.

Condizioni ed esclusioni

TRES COMERCIAL SL declina ogni responsabilità:

- In caso di prodotto non installato, mantenuto e pulito secondo le relative istruzioni incluse e disponibili su www.tresgriferia.com
- In caso di uso diverso del prodotto rispetto a quello previsto.
- In caso di montaggio di parti non originali o di segni di manipolazione impropria.
- In caso di difetti derivanti dal trasporto e/o dall'installazione.
- In caso di elementi reclamati soggetti a usura derivante dall'uso.
- In caso di difetto causato da elementi esterni aggressivi (prodotti chimici, detersivi corrosivi, installazione in ambienti aggressivi, eccessivo calcare, ghiaccio, ecc.)

- In caso di difetto causato da circostanze ambientali (sbalzi di pressione, temperature estreme, ecc.)
- In caso di mancanza di un componente, se non reclamato entro 30 giorni dalla data di acquisto.

Limiti della Garanzia

L'eventuale riparazione, sostituzione o qualsiasi servizio sul prodotto interessato non comporta l'estensione della presente Garanzia commerciale. Al fine di assicurare la validità della Garanzia, è necessaria in ogni caso l'accettazione del difetto da parte del nostro servizio tecnico. Nel caso in cui il prodotto analizzato non presenti alcun difetto coperto dalla Garanzia, verranno addebitate le seguenti spese per il Servizio tecnico:

- 12€ (IVA inclusa) più le spese di spedizione in caso di analisi del difetto presso gli stabilimenti di TRES COMERCIAL SL.
- Tariffa ufficiale del Servizio tecnico (disponibile per i clienti attraverso il dip. Commerciale) in caso di assistenza da parte del Servizio tecnico presso lo stabilimento.

La Garanzia commerciale copre solo la riparazione o la sostituzione del materiale senza alcun costo per il cliente, e in nessun caso siamo ritenuti responsabili per eventuali danni causati direttamente o indirettamente come risultato del difetto.

Pagamenti

Gli importi fatturati, salvo accordi speciali, saranno onorati attraverso bonifico bancario come massimo a 30 giorni dalla data di emissione della fattura. Per termini superiori verranno applicati interessi. In caso in cui esistano debiti scaduti e non pagati, ci riserviamo il diritto di annullare gli ordini in corso.

Riserva di dominio

TRES COMERCIAL SL sarà proprietaria di tutti i prodotti consegnati ai clienti fino al pagamento completo delle relative fatture.

MOLTO IMPORTANTE

Resi

TRES COMERCIAL SL non accetterà nessun reso di merce, senza che previamente il nostro agente la abbia accettato e comunicato.

- 1) TRES COMERCIAL SL non accetta nessun reso senza accettazione previa (la merce si restituirà al mittente)
- 2) TRES COMERCIAL SL non accetta nessun reso di merce che possa essere riparata con Ricambi Originali.
- 3) TRES COMERCIAL SL non accetta nessun reso di merce al di fuori della garanzia.
- 4) Nonostante, in caso di ricevere merce perfettamente imballata, essa sarà soggetta ad un deprezzamento in fattura di:

- Se è del anno in corso: **-15% deprezzamento**
- Se è anteriore a due anni: **-30% deprezzamento**
- Se è anteriore a tre anni: **-60% deprezzamento**

L'invio di merce dovrà effettuarsi a porto franco da parte del cliente.





TRES

www.tresgriferia.com

C/ Penedès, 16-26 | Zona Industrial, Sector A | 08759 Vallirana (Barcelona) SPAIN

United Kingdom | uk@tresgriferia.com | +34 93 683 40 27

Italia | italia@tresgriferia.com | +34 93 683 40 27

International | export@tresgriferia.com | +34 93 683 40 27

East Europe | eksport@tresgriferia.com | +48 42 611 05 40

 sat@tresgriferia.com | +34 93 683 41 34
reklamacje@tresgriferia.com | 0 42 611 05 41



REF. 7342025040 / ED. 01-2025