



TERMA

SINCE 1990

CENÍK DESIGNOVÝCH A EL. RADIÁTORŮ
(PLATNÝ OD 2023.09.01)



Představení a poslání značky TERMA

Jsme dlouholetý výrobce koupelnových a designových radiátorů, topných tyčí, bezvýkopových zařízení protlakem, strojů na průtahy optických kabelů a rehabilitačních zařízení. S více než 30 lety zkušeností sloužíme lidem ve více než 40 zemích světa na 4 kontinentech. Naším závazkem je vždy poskytovat nejvyšší kvalitu našich výrobků, což je projevem našeho respektu k zákazníkovi, jehož spokojenost je naší nejvyšší prioritou. Plnění Vašeho očekávání nám nestačí – chceme je překonat. Víme, že udržitelný vývoj lze dosáhnout pouze při spolupráci s nejlepšími v oborech. Práce s odborníky a kreativními lidmi proto umožňuje dosáhnout inovativních a funkčních řešení. Jsme dokonalí? Ne. Snaha o dokonalost je nejsilnějším motorem našich aktivit.

Činnost společnosti stojí na hodnotách, které jsou společným základem pro všechny procesy, které provádíme. Inovace, pečlivost, zodpovědnost, šetrnost k životnímu prostředí a pokora jsou součástí našeho každodenního života. Spokojenost ostatních nás inspiruje k hledání nových možností, jak ulehčit lidem život ve všech lidských činnostech. I proto financujeme vývoj designových a funkčních rehabilitačních přístrojů pro rovnání skoliózy, navrácení lidí po úraze zpět do života a pro trvale handicapované vyrábíme přístroje pro každodenní pomoc a radost z pohybu. V souladu s podmínkami volného trhu chceme našim partnerům nabídnout plnou podporu a pomoc k úspěchu v jejich podnikání a nabídnout spotřebitelům ty nejlepší produkty v poměru cena/kvalita.

Katalogy, ceníky a jiné materiály, které vám dáváme, jsou výsledkem práce více než 400 lidí. Jsou to jejich znalosti, zkušenosti, odhodlání a vášně, které každým rokem přinášejí do světa tisíce radiátorů. Ne všechny modely jsou uvedeny v této publikaci, proto vždy hledejte Novinky na našich internetových stránkách a ptejte se Obchodních manažerů. Úzce spolupracujeme s předními designéry a inženýry, vytváříme trendy v současných designových topných produktech. Již řadu let jsme uznávaní spotřebiteli, ale také designéry a odbornými sdruženími, což se odráží v každoročních cenách, které dostáváme. Je to důležité? Nejdůležitějším faktorem kvality naší práce je vaše volba. Věříme, že ilustrace v katalogu nejen splňují vaše očekávání, ale překračují je. Očekáváme, že budete k nám ještě náročnější. Teprve potom se můžeme ještě zlepšit.

OBSAH

- 16 Barvy
- 29 Modely Skladem
- 31 Litinové radiátory
- 53 Designové a el. radiátory
- 245 Elektrické topné tyče
- 271 Ventily a příslušenství
- 341 Sanitární příslušenství
- 355 Všeobecné obchodní podmínky
- 360 Tabulka přepočtu
- 361 Legenda
- 373 Kontakt

LITINOVÉ RADIÁTORY



BART
RADIÁTOR VODNÍ
Bart 32

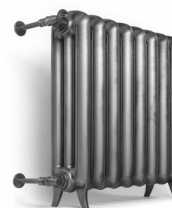

PLAIN 3K
RADIÁTOR VODNÍ
Plain 45



KASZUB
RADIÁTOR VODNÍ
Kaszub 34



PLAIN TOWEL RAIL
RADIÁTOR VODNÍ
Plain Towel Rail 49

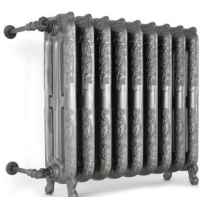

OXFORD
RADIÁTOR VODNÍ
Oxford 38



BERGAMO
RADIÁTOR VODNÍ
Bergamo 50



PLAIN
RADIÁTOR VODNÍ
Plain 41

DESIGNOVÉ A KOUPELNOVÉ RADIÁTORY

Vodní - Elektrické - Kombinované



AERO V
RADIÁTOR VODNÍ
Aero V 54

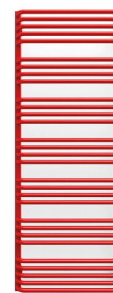

ALEX
RADIÁTOR VODNÍ /
VODNĚ-ELEKTRICKÝ
Alex 57
Alex One 59
ELEKTRICKÝ
Alex 58
Alex One 60

VÝZNAM PÍSMEN V NÁZVECH RADIÁTORŮ

H - Horizontální
D - Dvouřadý nebo dvojité
V - Vertikální
One - Radiátor se zabudovanou topnou
tyčí One
M - Zrcadlo
DW - Dělicí stěna
E - Elektrický

AERO H

RADIÁTOR VODNÍ
Aero H 55
Aero HG 56



ANGUS H

RADIÁTOR VODNÍ /
VODNĚ-ELEKTRICKÝ
Angus H 65
ELEKTRICKÝ
Angus H 66



ANGUS V

RADIÁTOR VODNÍ /
VODNĚ-ELEKTRICKÝ
Angus V 61
Angus DW 63
ELEKTRICKÝ
Angus VE 62
Angus DWE 64





NOVINKA
BOOKIE

RADIÁTOR VODNÍ
Bookie 67



CRYSTAL

RADIÁTOR VODNÍ
Crystal 82
ELEKTRICKÝ
Crystal 83



FIONA

RADIÁTOR VODNÍ /
VODNĚ-ELEKTRICKÝ
Fiona 97
Fiona One 101
ELEKTRICKÝ
Fiona 99
Fiona One 102



BONE

RADIÁTOR VODNÍ /
VODNĚ-ELEKTRICKÝ
Bone 68
Bone DW 69
Bone One 70
ELEKTRICKÝ
Bone 53
Bone DW 69
Bone One 71

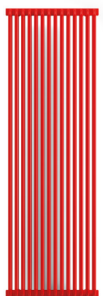

DELFIN

RADIÁTOR VODNÍ /
VODNĚ-ELEKTRICKÝ
Delfin 84
ELEKTRICKÝ
Delfin 85

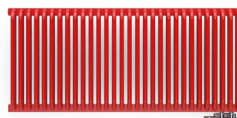

NOVINKA
FORTE

RADIÁTOR VODNÍ
Forte V10 104
Forte V20 105

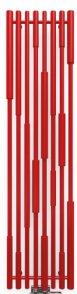

CANE

RADIÁTOR VODNÍ /
VODNĚ-ELEKTRICKÝ
Cane 72
ELEKTRICKÝ
Cane E 72



DEXTER

RADIÁTOR VODNÍ /
VODNĚ-ELEKTRICKÝ
Dexter 86
Dexter One 88
ELEKTRICKÝ
Dexter 87
Dexter One 89



NOVINKA
GRID

RADIÁTOR VODNÍ /
VODNĚ-ELEKTRICKÝ
Grid 106
ELEKTRICKÝ
Grid 106



CASE SLIM

RADIÁTOR VODNÍ /
VODNĚ-ELEKTRICKÝ
Case Slim 73
ELEKTRICKÝ
Case Slim 75



DIAMOND

RADIÁTOR VODNÍ /
VODNĚ-ELEKTRICKÝ
Diamond 90
ELEKTRICKÝ
Diamond 91



HEX

RADIÁTOR VODNÍ
Hex 107



CITY

RADIÁTOR VODNÍ /
VODNĚ-ELEKTRICKÝ
City 76
City One 78
ELEKTRICKÝ
City 77
City One 79



DOMI

RADIÁTOR VODNÍ /
VODNĚ-ELEKTRICKÝ
Domi 92
ELEKTRICKÝ
Domi 93



INCORNER

RADIÁTOR VODNÍ /
VODNĚ-ELEKTRICKÝ
Incorner 108
ELEKTRICKÝ
Incorner 108



CYKLON V

RADIÁTOR VODNÍ
Cyclon V 80

CYKLON H

RADIÁTOR VODNÍ
Cyclon H 81



EASY

RADIÁTOR VODNÍ /
VODNĚ-ELEKTRICKÝ
Easy 94
Easy DW 95
Easy One 96
ELEKTRICKÝ
Easy 89
Easy DW 95
Easy One 96

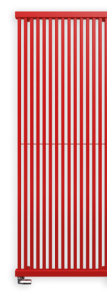

INTRA

RADIÁTOR VODNÍ
Intra 109
Intra M 110



IRON D

RADIÁTOR VODNÍ /
VODNĚ-ELEKTRICKÝ
Iron D 111

ELEKTRICKÝ
Iron D 113



MARLIN

RADIÁTOR VODNÍ /
VODNĚ-ELEKTRICKÝ
Marlin 129
Marlin One 131

ELEKTRICKÝ
Marlin 130
Marlin One 132

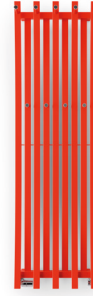

NOVINKA
PASSO HX

RADIÁTOR VODNÍ
Passo HX 144



IRON S

RADIÁTOR VODNÍ /
VODNĚ-ELEKTRICKÝ
Iron S 114

ELEKTRICKÝ
Iron S 115



MICHELLE

RADIÁTOR VODNÍ /
VODNĚ-ELEKTRICKÝ
Michelle 133

ELEKTRICKÝ
Michelle 134



NOVINKA
PASSO MH

RADIÁTOR VODNÍ
Passo MH 145



KIOTO

RADIÁTOR VODNÍ /
VODNĚ-ELEKTRICKÝ
Kioto 117
Kioto One 118

ELEKTRICKÝ
Kioto 117
Kioto One 118



MIKE

RADIÁTOR VODNÍ /
VODNĚ-ELEKTRICKÝ
Mike 135
Mike One 137

ELEKTRICKÝ
Mike 135
Mike One 137



PERŁA

RADIÁTOR VODNÍ
Perła 146

ELEKTRICKÝ
Perła E 147



LENA

RADIÁTOR VODNÍ /
VODNĚ-ELEKTRICKÝ
Lena 119

ELEKTRICKÝ
Lena 121



NEMO

RADIÁTOR VODNÍ /
VODNĚ-ELEKTRICKÝ
Nemo 139

ELEKTRICKÝ
Nemo 140



PIER

RADIÁTOR VODNÍ
Pier 148



LIMA

RADIÁTOR VODNÍ /
VODNĚ-ELEKTRICKÝ
Lima 123
Lima One 125

ELEKTRICKÝ
Lima 124
Lima One 112



OUTCORNER

RADIÁTOR VODNÍ /
VODNĚ-ELEKTRICKÝ
Outcorner 141

ELEKTRICKÝ
Outcorner 141

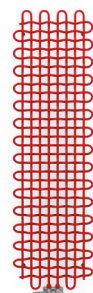

PLC V

RADIÁTOR VODNÍ
PLC V 149



LUKKA

RADIÁTOR VODNÍ /
VODNĚ-ELEKTRICKÝ
Lukka 127

ELEKTRICKÝ
Lukka 128



PAJAŁ

RADIÁTOR VODNÍ /
VODNĚ-ELEKTRICKÝ
Pająk 142

ELEKTRICKÝ
Pająk E 143

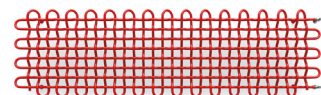

PLC H

RADIÁTOR VODNÍ
PLC H 150



POC 2

RADIÁTOR VODNÍ /
VODNĚ-ELEKTRICKÝ
POC 2 151

ELEKTRICKÝ
POC 2 152

RIBBON H

RADIÁTOR VODNÍ
Ribbon HSD 163
Ribbon HWS 164

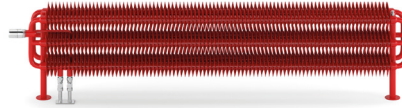

SPIRO

ELEKTRICKÝ
Spiro 175



POLA

RADIÁTOR VODNÍ /
VODNĚ-ELEKTRICKÝ
Pola 153
Pola One 154

ELEKTRICKÝ
Pola 153
Pola One 154



NOVINKA ROLO HANGER

RADIÁTOR VODNÍ/
VODNĚ-ELEKTRICKÝ
Rolo Hanger 165

ELEKTRICKÝ
Rolo Hanger E 165



STAND

RADIÁTOR VODNÍ /
VODNĚ-ELEKTRICKÝ
Stand 177

ELEKTRICKÝ
Stand E 178



QUADRUS BOLD

RADIÁTOR VODNÍ /
VODNĚ-ELEKTRICKÝ
Quadrus Bold 155
Quadrus Bold One 156

ELEKTRICKÝ
Quadrus Bold 155
Quadrus Bold One 156



ROLO ROOM

RADIÁTOR VODNÍ
Rolo Room 167

ELEKTRICKÝ
Rolo Room E 168

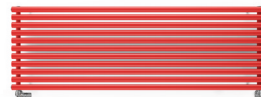

NOVINKA STRATO

RADIÁTOR VODNÍ /
VODNĚ-ELEKTRICKÝ
Strato 179

ELEKTRICKÝ
Strato E 179



QUADRUS SLIM

RADIÁTOR VODNÍ /
VODNĚ-ELEKTRICKÝ
Quadrus Slim 157
Quadrus Slim One 158

ELEKTRICKÝ
Quadrus Slim 157
Quadrus Slim One 158

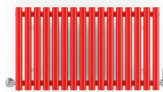

SHERWOOD H

RADIÁTOR VODNÍ
Sherwood H 169



NOVINKA SWALE

RADIÁTOR VODNÍ
Swale 181



RETRO

RADIÁTOR VODNÍ /
VODNĚ-ELEKTRICKÝ
Retro 159
Retro S 160

ELEKTRICKÝ
Retro 159



SHERWOOD V

RADIÁTOR VODNÍ /
VODNĚ-ELEKTRICKÝ
Sherwood V 170

ELEKTRICKÝ
Sherwood VE 171



TRIGA

RADIÁTOR VODNÍ /
VODNĚ-ELEKTRICKÝ
Triga 182
Triga M 192

ELEKTRICKÝ
Triga E 184
Triga ME 193

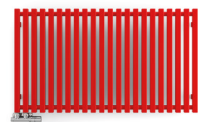

RIBBON V

RADIÁTOR VODNÍ
Ribbon V 161

ELEKTRICKÝ
Ribbon VE 162



SIMPLE

RADIÁTOR VODNÍ /
VODNĚ-ELEKTRICKÝ
Simple 172
Simple One 174
Simple DW 176

ELEKTRICKÝ
Simple 173
Simple One 175
Simple DW 176



TRIGA AN

RADIÁTOR VODNÍ
Triga AN 186
Triga ANC 188

ELEKTRICKÝ
Triga AN E 187
Triga ANCE 189



TRIGA AW

RADIÁTOR VODNÍ
Triga AW 190

ELEKTRICKÝ
Triga AW E 191



NOVINKA WARP ROOM

RADIÁTOR VODNÍ
Warp Room 211

ELEKTRICKÝ
Warp Room 212



TUNE H

RADIÁTOR VODNÍ
Tune HSD 194



WARP S

RADIÁTOR VODNÍ /
VODNĚ-ELEKTRICKÝ
Warp S 213

ELEKTRICKÝ
Warp S 213



TUNE V

RADIÁTOR VODNÍ /
VODNĚ-ELEKTRICKÝ

Tune VWD 195 Tune VWDE 196
Tune VWS 197 Tune VWSE 198

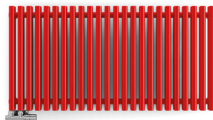

WARP T

RADIÁTOR VODNÍ /
VODNĚ-ELEKTRICKÝ

Warp T 214
Warp T One 215
Warp T Bold 216
Warp T Bold One 217

ELEKTRICKÝ
Warp T 214
Warp T One 215
Warp T Bold 216
Warp T Bold One 217



TYTUS

RADIÁTOR VODNÍ /
VODNĚ-ELEKTRICKÝ

Tytus 199
Tytus One 201

ELEKTRICKÝ
Tytus 200
Tytus One 202

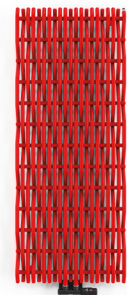

NOVINKA WILLOW

RADIÁTOR VODNÍ
Willow 218



VIPERA

RADIÁTOR VODNÍ /
VODNĚ-ELEKTRICKÝ

Vípera 203
Vípera One 205

ELEKTRICKÝ
Vípera 204
Vípera One 206



ZIGZAG

RADIÁTOR VODNÍ /
VODNĚ-ELEKTRICKÝ

ZigZag 219

ELEKTRICKÝ
ZigZag 220



VIVO

RADIÁTOR VODNÍ /
VODNĚ-ELEKTRICKÝ

Vivo 207
Vivo One 209

ELEKTRICKÝ
Vivo 208
Vivo One 210

SMART WI-FI



VOLTAN
226



VEO
227



SS1
228



VAZ
229



VTS
231



VOS
231

BLOWER



BLOWER
236



ALEX BLOWER
237

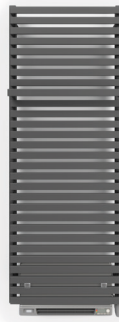

CITY BLOWER
237



FIONA BLOWER
238



LIMA BLOWER
238



MARLIN
BLOWER
239



POLA BLOWER
239



QUADRUS
BOLD BLOWER
240



QUADRUS
SLIM BLOWER
240



TYTUS BLOWER
241



WARP T
BLOWER
241



WARP T
BOLD BLOWER
242

ELEKTRICKÉ TOPNÉ TYČE



ONE
250



MOA IR
258



SIM
265



KTX 4 BLUE
252



MOA
259



Krytka SIM
266



KTX 4
253



DRY
260



TS1
267



KTX 3
254



TDY
261



TNK
267



KTX 2
255



MEG
262



TTIR1
268



KTX 1
256



REG 3
263



DTIR1
269



MOA BLUE
257



REG 2
264

VENTILY A PŘÍSLUŠENSTVÍ

POLIČKY, DRŽÁKY A HÁČKY NA RUČNÍKY

Police EASY	273
Police SIMPLE	273
Police STAND	274
Police TRIGA	275
Police s držákem TRIGA	276
Držák TRIGA.....	277
Držák BELT.....	277
Háček bodový HANDY GRIP	278
Háček bodový HANDY VIP	278
Háček bodový KUKA.....	279
Háček bodový SPARK	279
Háček Yo!	280

SADY VENTILŮ

Sada Dexter regulační.....	287
Sada Dexter termostatická.....	288
Sada termostatická „Wood“	289
Sada rohová regulační	290
Sada rohová regulační Star	291
Sada rohová termostatická	292
Sada tříosová regulační	293
Sada tříosová termostatická	294
Sada tříosová term. s možností montáže topné tyče skrz ventil.....	295
Integrovaná sada termostatická.....	296
Sada komplexní integrovaný ventil s T- kusem s možností připojení topné tyče skrze ventil.....	297
Integrovaná sada termostatická s ponornou trubicí	298
Integrovaná sada uzavírací	299
Integrovaná sada termostatická TWINS.....	300
Integrovaná sada termostatická s ponornou trubicí UNICO	301
Sada tříosová termostatická INTEGRA.....	302
Sada tříosová termostatická VISION	303

Háček bodový ZIP H	281
Háček bodový ZIP V.....	281
Držák vyhnutý BASIC.....	281
Držák BASIC.....	282
Háček HAPPY HIPPO	282
Háček HAPPY RABBIT	283
Háček HAPPY SHARK.....	283
Háček SIMPLE.....	284
Držák CASE SLIM.....	284
Náhradní stoupačkový profil k radiátoru.....	285
Náhradní stoupačkový profil k radiátoru Iron D a Iron S	285

Sada tříosová regulační VISION	304
Integrovaná sada PREMIUM	305
Sada rohová termostatická ALL IN ONE.....	306
Sada krycí integrovaná	307
Sada rohová regulační „Classic Art“	308
Sada rohová regulační „Minimalist“	308
Sada rohová termostatická „Artistic“	309
Sada regulační termostatická „Wood“	309
Sada krycí dvojitá „Artistic“	310
Sada krycí dvojitá.....	310
Adaptér AL-PEX – 24 × 19	311
Adaptér ocel – 24 × 19	311
Adaptér měď – 24 × 19.....	312
Odvzdušňovací ventil	312
Redukce 5/4" x 1/2"	313
Zátka EUro 5/4"	313
Vsuvka pro spojení článků.....	313
Těsnění pro litinový radiátor.....	314
Montážní klíč na spojování článků	314
Hák.....	314

VENTILY A PŘÍSLUŠENSTVÍ

Komplexní integrovaný termostatický ventil s ponornou trubicí	316
Komplexní integrovaný termostatický ventil přímý s ponornou	317
Komplexní integrovaný termostatický ventil..	318
Komplexní integrovaný termostatický přímý	319
Komplexní integrovaný ventil s T- kusem s možností připojení topné tyče skrze ventil	320
Ventil uzavírací integrovaný s T- kusem pro připojení topné tyče skrze ventil	321
Ventil integrovaný uzavírací	322
Ventil tříosý termostatický	323
Ventil tříosý regulační	324
Ventil tříosý uzavírací	325
Ventil rohový termostatický	325
Ventil rohový regulační	326
Ventil rohový uzavírací	326
Ventil termostatický přímý	327
Ventil regulační přímý	327
Ventil uzavírací přímý	328
T - KUS	328
Ventil regulační rohový Minimalist	329
Ventil regulační rohový Star	329

SANITÁRNÍ PŘÍSLUŠENSTVÍ

Madlo rovné	342
Madlo pravoúhlé 90°	343
Madlo pravoúhlé 125°	344
Madlo vodorovné	345
Opěrné madlo svislé	346
Opěrné madlo vodorovné	347
Opěrné madlo volně stojící	348

INFORMACE

Všeobecné obchodní podmínky	355
Tabulka přepočtu výkonu	360

Adaptér AL-PEX – 24 × 19	330
Adaptér AL-PEX – 3/4"	330
Adaptér AL-PEX – M22 × 1,5	331
Adaptér měď – 24 × 19	331
Adaptér měď – 3/4"	332
Adaptér měď – M22 × 1,5	332
Adaptér ocel – 24 × 19	333
Adaptér ocel – M22 × 1,5	333
Termostatická hlavice ETNA	334
Termostatická hlavice NOBLE	334
Termostatická hlavice SLIM	335
Zátka 7mm	335
Zátka 3mm	336
Distanční matice	336
Odvzdušňovací ventil	337
Sada krycí dvojitá	337
Sada krycí integrovaná	338
Sada speciálních klíčů TERMA	338
Prodlužovací trubice	339
Čistící kartáč dlouhý	339
Čistící kartáč Ribbon	339





Madlo nástěnné	349
Madlo nástěnné s držákem	350
Madlo sklopné	351
Madlo sklopné s držákem	352
Sprchové sedátko DIS	353
Hygienický atest	354

Konstrukce kódu konfigurace radiátoru 363 – 371	
Kontakt	373

Barvy

Uvedené barvy se mohou mírně lišit od skutečných. Pro přesný výběr barev použijte originální vzorník, který je k dispozici u našich obchodních manažerů a prodejních partnerů.

VZORNÍK SPECIÁLNÍCH BAREV

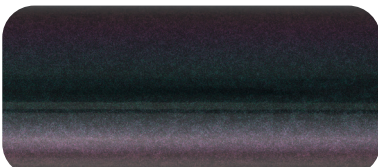
PALETA KOLORÓW RAL RAL COLOURS PALETTE RAL FARBPALETTE NUANCIER RAL ПАЛИТРА ЦВЕТОВ			
	9M5 <small>KOD</small>	Anodic Black	ABC
	9P5	Sterling	STE
	S95	Modern Grey	DGR
	MBC	Sparkling Grey	RGY
	IHE	Metallic Grey	MGR
	MPR	Granite	GRA
		Inox	INO
		Storm Sky	SSK
		Winter Sky	WSK
		Salt&Pepper	SPP
		Diamond Silver	DIS
		Silver Matt	SMA



Black Crocodile **BLN**



Graphite **GRP**



Nature **NAT**

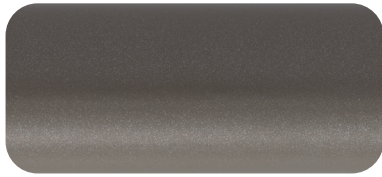

Sparkling Gravel **RGR**



California Beige **ICB**

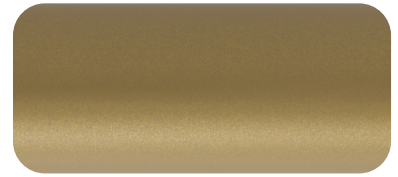

Anodic Gold **AGO**



Anodic Sapphire **ASP**

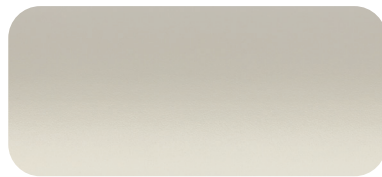

Blush **BUH**

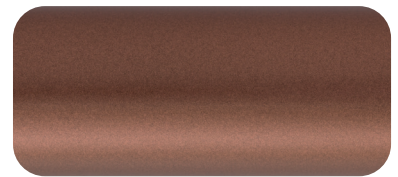

Copper **COP**



Pastel Blue **PBL**



Soft 9016 **S96**



Bright Copper **BCO**

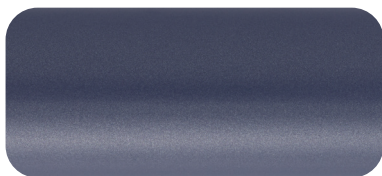

Blueberry **BLR**

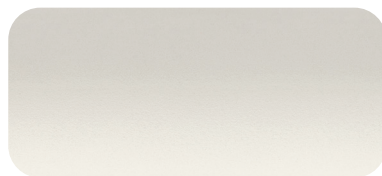

White Wall **WWL**



Lotus **LOT**



Denim **DEM**

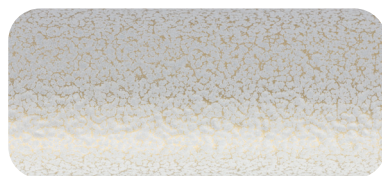

White Gold **WGD**



Sienna **SIA**



Green Chlorophyll **GCL**



Sparkling Cream **RCR**



Aubergine **ABG**



Soft Green Apple **SGA**



Quartz **QUA**



Anodic Brown **ABN**

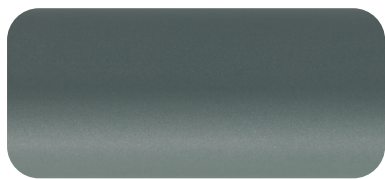

Anodic Malachite **AMT**



Halo **HAL**



Dark Bronze **DRB**



Noble Brown **INB**

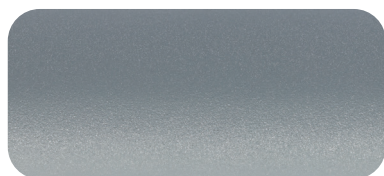

Metallic Silver **MSI**



Groovy Red **GRR**



Vibrant Brown **OVB**

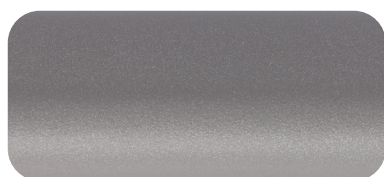

Metallic Beige **MBE**



Metallic Red **MRE**

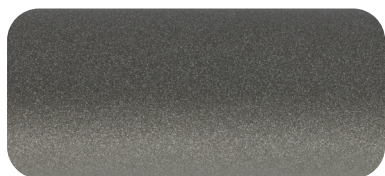

Metallic Stone **MST**



Lavender **LAV**



Soft 3028 **S38**



Chrom **CRO**

GALVANICKÁ POVRCHOVÁ ÚPRAVA

Radiátory i v Chromu: ALEX, BONE, DEXTER, DIAMOND, DOMI, EASY, FIONA, INTRA, LENA, LIMA, MARLIN, MICHELLE, MIKE, PERŁA, POLA, RETRO, SIMPLE, SPIRO, VIVO, ZIGZAG.

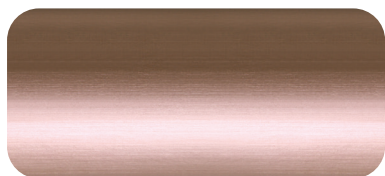

Raw copper **MIE**

RAW COPPER

Barevná varianta dostupná pouze pro Pajak a Pajak E. Vzhledem ke svým vlastnostem může povrch časem změnit barvu, ztmavnout.

VZORNÍK BAREV PREMIUM

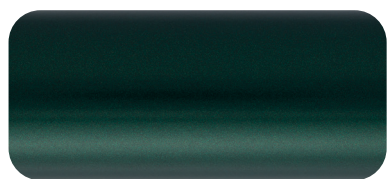

Bottle Green

BGR



Champagne

CPG



Red Wine

RWE

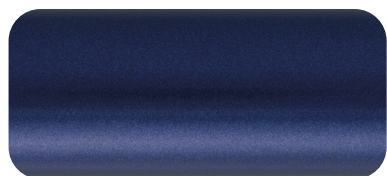

Midnight

MDN

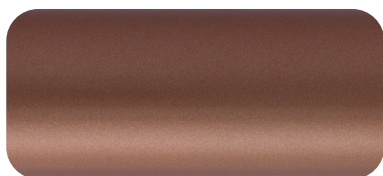

Pers

PER

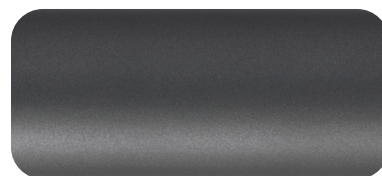

Raw Metal

RAW



Brushed Brass

BBS



Old Bronze

OBZ

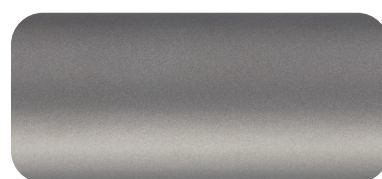

Metal Alive

MAV



Brass

BRA



True Copper Bright

TCG

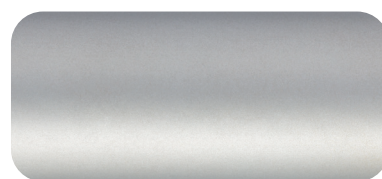

Silver

SVR

Barvy PREMIUM jsou s příplatkem 25% i z důvodu dražší technologie lakování.

Možné jsou na všechny radiátory TERMA a ventily ALL IN ONE kromě:

BERGAMO, CASE SLIM, DELFIN, IRON D A S, KIOTO, NEMO, QUADRUS BOLD, VŠECHNY RIBBON, TUNE VWD, TUNE HSD, TRP, TYTUS, VOLTAN, WARP S, WARP T BOLD, WARP ROOM, WILLOW.

POZOR: Barva Brushed Brass nelze aplikovat na modely ANGUS, CANE, HEX, PLC, TRP, všechny TRIGA a SHERWOOD.

SPECIÁLNÍ NÁTĚRY

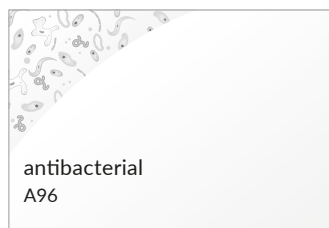

Je bílý antibakteriální finální nátěr (RAL 9016). Obsahuje molekuly stříbra. Uvolňující se ionty stříbra ničí bakterie a brání růstu plísní a hub. Použití tohoto nátěru je doporučeno hlavně pro výrobky v sanitárních místnostech, potravinářských a zdravotnických provozech. Cena radiátoru při zvolení antibakteriálního nátěru je +25% k ceně v obrázkovém ceníku ve sloupci Barvy RAL a speciální barvy nebo ve sloupci Standardní barvy, pokud tento je.

VZORNÍK ÚPRAV PRO LITINOVÉ RADIÁTORY

Kromě standardních 190 barev RAL SKUPINA 1 (nanášených ponorným máčením) nabízíme řadu speciálních barev a řadu povrchových dekorativních úprav. Na přání zákazníka provádíme povrchovou úpravu radiátorů a příslušenství dle individuálních požadavků.

SKUPINA 1



White Soft

WS3



Frost

FR3



Metallic Brown

AB3



Autumn

AU3



Evening Garden

EG3



Shadow Gold

SG3



Graff

GR3



Flat Black

FB3



Raw Metal

ZE3



Metal Alive

ZE1



Paleta RAL

SKUPINA 2



Antique Copper

AC5



Antique Brass

AN5



Full Burnish

FB2



Bottle Green

BGR



Shaded Burnish

FB4

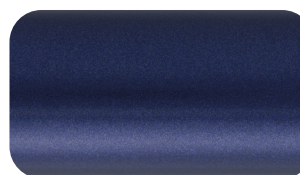

Midnight

MDN



Red Wine

RWE

SKUPINA 3



Ornament Gold*

GR7



Ornament Silver*

GR9



Ornament Copper*

GR8



Galvanic Copper

GC5

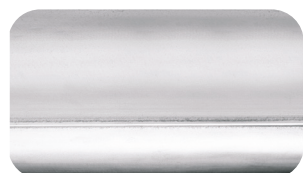

Polished Metal

ZE2

* Plocha může být provedena v libovolné barvě ze SKUPINY 1 Vzorníku pro litinové radiátory a vystouplé ornamenty ručně malované mohou být zlaté, stříbrné nebo měděné.

BARVY PRO RADIÁTOR BERGAMO

Dostupný v níže uvedených TERMA speciálních barvách + ve všech RAL uvedených na následujících stránkách.



Metallic Black

MBC



California Beige

ICB



Vibrant Brown

OVB



Heban

IHE

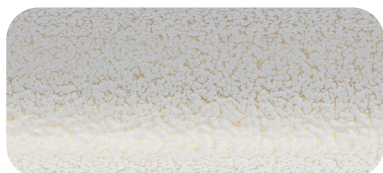

White Gold

WGD

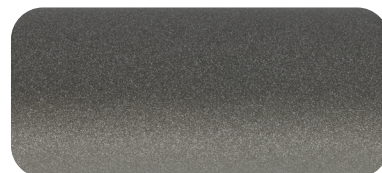

Metallic Stone

MST



Metallic Grey

MGR



White Wall

WWL

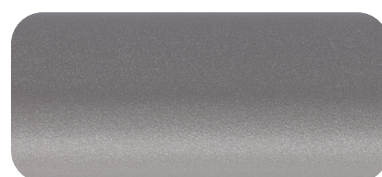

Metallic Beige

MBE



Graphite

GRP



White Matt

WMA



Metallic Red

MRE



Salt&Pepper

SPP



Quartz

QUA



Anthracite

ANT



Metallic Silver

MSI



Noble Brown

INB



Modern Grey

DGR

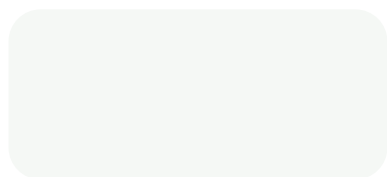

RAL 9016

916

RAL 9016 jen pro 10 článkový radiátor Bergamo

VZORNÍK BAREV RAL (75% LESKU)



RAL 1000 **100**
MAT A00 | SOFT S10



RAL 1007 **107**
MAT A07 | SOFT S17



RAL 1017 **117**
MAT A17 | SOFT S07



RAL 1027 **127**
MAT A27 | SOFT R17



RAL 1001 **101**
MAT A01 | SOFT S11



RAL 1011 **111**
MAT A11 | SOFT S01



RAL 1018 **118**
MAT A18 | SOFT S08



RAL 1028 **128**
MAT A28 | SOFT R18



RAL 1002 **102**
MAT A02 | SOFT S12



RAL 1012 **112**
MAT A12 | SOFT S02



RAL 1019 **119**
MAT A19 | SOFT S19



RAL 1032 **132**
MAT A32 | SOFT R12



RAL 1003 **103**
MAT A03 | SOFT S03

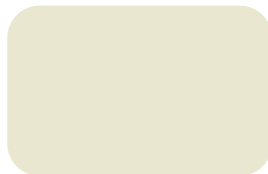

RAL 1013 **113**
MAT A13 | SOFT R13



RAL 1020 **120**
MAT A20 | SOFT R10



RAL 1033 **133**
MAT A33 | SOFT R03



RAL 1004 **104**
MAT A04 | SOFT S14



RAL 1014 **114**
MAT A14 | SOFT S04



RAL 1021 **121**
MAT A21 | SOFT R11



RAL 1034 **134**
MAT A34 | SOFT R04



RAL 1005 **105**
MAT A05 | SOFT S15



RAL 1015 **115**
MAT A15 | SOFT S05



RAL 1023 **123**
MAT A23 | SOFT S13



RAL 1037 **137**
MAT A37 | SOFT R07



RAL 1006 **106**
MAT A06 | SOFT S16



RAL 1016 **116**
MAT A16 | SOFT S06



RAL 1024 **124**
MAT A24 | SOFT R14



RAL 2000 **200**
MAT B00 | SOFT S20



RAL 2001 **201**
MAT B01 | SOFT S21

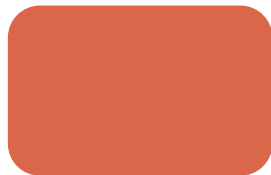

RAL 2012 **212**
MAT B12 | SOFT R22



RAL 3009 **309**
MAT C09 | SOFT S39



RAL 3018 **318**
MAT C18 | SOFT R38



RAL 2002 **202**
MAT B02 | SOFT S22



RAL 3000 **300**
MAT C00 | SOFT S30



RAL 3011 **311**
MAT C11 | SOFT R31



RAL 3020 **320**
MAT C20 | SOFT S36



RAL 2003 **203**
MAT B03 | SOFT S23



RAL 3001 **301**
MAT C01 | SOFT S31



RAL 3012 **312**
MAT C12 | SOFT R32



RAL 3022 **322**
MAT C22 | SOFT R02



RAL 2004 **204**
MAT B04 | SOFT S24



RAL 3002 **302**
MAT C02 | SOFT S32



RAL 3013 **313**
MAT C13 | SOFT R33



RAL 3027 **327**
MAT C27 | SOFT S27



RAL 2008 **208**
MAT B08 | SOFT S28



RAL 3003 **303**
MAT C03 | SOFT S33



RAL 3014 **314**
MAT C14 | SOFT R34



RAL 3028 **328**
MAT C28 | SOFT S38



RAL 2009 **209**
MAT B09 | SOFT S29



RAL 3004 **304**
MAT C04 | SOFT S34



RAL 3015 **315**
MAT C15 | SOFT R35



RAL 3031 **331**
MAT C31 | SOFT R01



RAL 2010 **210**
MAT B10 | SOFT R20



RAL 3005 **305**
MAT C05 | SOFT S35



RAL 3016 **316**
MAT C16 | SOFT R36



RAL 4001 **401**
MAT D01 | SOFT S41



RAL 2011 **211**
MAT B11 | SOFT R21

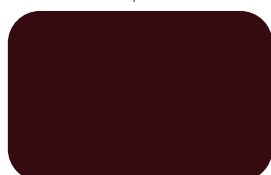

RAL 3007 **307**
MAT C07 | SOFT S37



RAL 3017 **317**
MAT C17 | SOFT R37



RAL 4002 **402**
MAT D02 | SOFT S42



RAL 4003 **403**
MAT **D03** | SOFT **S43**



RAL 5000 **500**
MAT **E00** | SOFT **S50**



RAL 5009 **509**
MAT **E09** | SOFT **S59**



RAL 5018 **518**
MAT **E18** | SOFT **R58**



RAL 4004 **404**
MAT **D04** | SOFT **S44**



RAL 5001 **501**
MAT **E01** | SOFT **S51**



RAL 5010 **510**
MAT **E10** | SOFT **R50**



RAL 5019 **519**
MAT **E19** | SOFT **R59**



RAL 4005 **405**
MAT **D05** | SOFT **S45**



RAL 5002 **502**
MAT **E02** | SOFT **R52**



RAL 5011 **511**
MAT **E11** | SOFT **R51**



RAL 5020 **520**
MAT **E20** | SOFT **S56**



RAL 4006 **406**
MAT **D06** | SOFT **S46**



RAL 5003 **503**
MAT **E03** | SOFT **S53**



RAL 5012 **512**
MAT **E12** | SOFT **S52**



RAL 5021 **521**
MAT **E21** | SOFT **R05**



RAL 4007 **407**
MAT **D07** | SOFT **S47**



RAL 5004 **504**
MAT **E04** | SOFT **S54**



RAL 5013 **513**
MAT **E13** | SOFT **R53**



RAL 5022 **522**
MAT **E22** | SOFT **R06**



RAL 4008 **408**
MAT **D08** | SOFT **S48**



RAL 5005 **505**
MAT **E05** | SOFT **S55**



RAL 5014 **514**
MAT **E14** | SOFT **R54**



RAL 5023 **523**
MAT **E23** | SOFT **R08**



RAL 4009 **409**
MAT **D09** | SOFT **S49**



RAL 5007 **507**
MAT **E07** | SOFT **S57**



RAL 5015 **515**
MAT **E15** | SOFT **R55**



RAL 5024 **524**
MAT **E24** | SOFT **R56**



RAL 4010 **410**
MAT **D10** | SOFT **S40**



RAL 5008 **508**
MAT **E08** | SOFT **S58**



RAL 5017 **517**
MAT **E17** | SOFT **R57**



RAL 6000 **600**
MAT **F00** | SOFT **S60**



RAL 6001 **601**
MAT **F01** | SOFT **R16**



RAL 6009 **609**
MAT **F09** | SOFT **S69**



RAL 6017 **617**
MAT **F17** | SOFT **R67**



RAL 6026 **626**
MAT **F26** | SOFT **R26**



RAL 6002 **602**
MAT **F02** | SOFT **S62**



RAL 6010 **610**
MAT **F10** | SOFT **R60**



RAL 6018 **618**
MAT **F18** | SOFT **R68**



RAL 6027 **627**
MAT **F27** | SOFT **R27**



RAL 6003 **603**
MAT **F03** | SOFT **S63**



RAL 6011 **611**
MAT **F11** | SOFT **R61**



RAL 6019 **619**
MAT **F19** | SOFT **R69**



RAL 6028 **628**
MAT **F28** | SOFT **R28**



RAL 6004 **604**
MAT **F04** | SOFT **S64**



RAL 6012 **612**
MAT **F12** | SOFT **R62**



RAL 6020 **620**
MAT **F20** | SOFT **R09**



RAL 6029 **629**
MAT **F29** | SOFT **R29**



RAL 6005 **605**
MAT **F05** | SOFT **S65**



RAL 6013 **613**
MAT **F13** | SOFT **R63**



RAL 6021 **621**
MAT **F21** | SOFT **S61**



RAL 6032 **632**
MAT **F32** | SOFT **R23**



RAL 6006 **606**
MAT **6M6** | SOFT **S66**



RAL 6014 **614**
MAT **F14** | SOFT **R64**



RAL 6022 **622**
MAT **F22** | SOFT **S26**



RAL 6033 **633**
MAT **F33** | SOFT **R15**



RAL 6007 **607**
MAT **F07** | SOFT **S67**



RAL 6015 **615**
MAT **F15** | SOFT **R65**



RAL 6024 **624**
MAT **F24** | SOFT **R24**

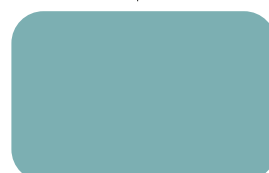

RAL 6034 **634**
MAT **F34** | SOFT **R39**



RAL 6008 **608**
MAT **F08** | SOFT **S68**



RAL 6016 **616**
MAT **F16** | SOFT **R66**



RAL 6025 **625**
MAT **6M5** | SOFT **R25**



RAL 6037 **637**
MAT **F37** | SOFT **O37**



RAL 7000 **700**
MAT G00 | SOFT R70



RAL 7009 **709**
MAT G09 | SOFT S79



RAL 7022 **722**
MAT 7M1 | SOFT S18



RAL 7034 **734**
MAT G34 | SOFT R94



RAL 7001 **701**
MAT G01 | SOFT S71



RAL 7010 **710**
MAT G10 | SOFT R40



RAL 7023 **723**
MAT M23 | SOFT S19



RAL 7035 **735**
MAT M35 | SOFT R95



RAL 7002 **702**
MAT G02 | SOFT R72



RAL 7011 **711**
MAT G11 | SOFT R71



RAL 7024 **724**
MAT 7M4 | SOFT S74



RAL 7036 **736**
MAT G36 | SOFT R45



RAL 7003 **703**
MAT G03 | SOFT R73



RAL 7012 **712**
MAT G12 | SOFT S72



RAL 7026 **726**
MAT G26 | SOFT S25



RAL 7037 **737**
MAT G37 | SOFT R47



RAL 7004 **704**
MAT G04 | SOFT R74



RAL 7013 **713**
MAT G13 | SOFT R43



RAL 7030 **730**
MAT G30 | SOFT S70



RAL 7038 **738**
MAT G38 | SOFT R78



RAL 7005 **705**
MAT G05 | SOFT S75



RAL 7015 **715**
MAT G15 | SOFT R75



RAL 7031 **731**
MAT G31 | SOFT R49



RAL 7039 **739**
MAT G39 | SOFT R79



RAL 7006 **706**
MAT G06 | SOFT R76



RAL 7016 **716**
MAT 7M6 | SOFT S76



RAL 7032 **732**
MAT 7M3 | SOFT R92



RAL 7040 **740**
MAT 7M0 | SOFT R48



RAL 7008 **708**
MAT G08 | SOFT S78



RAL 7021 **721**
MAT G21 | SOFT R41



RAL 7033 **733**
MAT G33 | SOFT R93



RAL 7042 **742**
MAT 7M2 | SOFT R42



RAL 7043 **743**
MAT **G43** | SOFT **S73**



RAL 8003 **803**
MAT **H03** | SOFT **S83**



RAL 8016 **816**
MAT **H16** | SOFT **R86**



RAL 9001 **901**
MAT **9M1** | SOFT **S91**



RAL 7044 **744**
MAT **G44** | SOFT **754**



RAL 8004 **804**
MAT **H04** | SOFT **R84**



RAL 8017 **817**
MAT **H17** | SOFT **S87**



RAL 9002 **902**
MAT **I02** | SOFT **S92**



RAL 7045 **745**
MAT **7M5** | SOFT **R44**



RAL 8007 **807**
MAT **H07** | SOFT **R87**



RAL 8019 **819**
MAT **H19** | SOFT **R89**

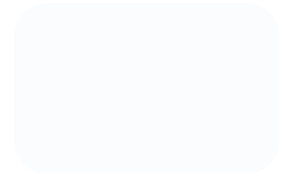

RAL 9003 **903**
MAT **9M3** | SOFT **S93**



RAL 7046 **746**
MAT **G46** | SOFT **R46**



RAL 8008 **808**
MAT **H08** | SOFT **S88**



RAL 8022 **822**
MAT **M82** | SOFT **R80**



RAL 9004 **904**
MAT **9M4** | SOFT **S94**



RAL 7047 **747**
MAT **M77** | SOFT **S77**



RAL 8011 **811**
MAT **8M1** | SOFT **R81**



RAL 8023 **823**
MAT **H23** | SOFT **R83**



RAL 9006 **906**
MAT **9M6** | SOFT **R96**



RAL 8000 **800**
MAT **H00** | SOFT **S80**



RAL 8012 **812**
MAT **H12** | SOFT **R82**



RAL 8024 **824**
MAT **H24** | SOFT **S84**



RAL 9007 **907**
MAT **9M7** | SOFT **S97**



RAL 8001 **801**
MAT **H01** | SOFT **S81**



RAL 8014 **814**
MAT **8M4** | SOFT **S89**



RAL 8025 **825**
MAT **H25** | SOFT **S85**

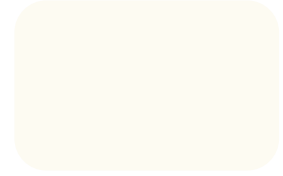

RAL 9010 **910**
MAT **9M0** | SOFT **S90**



RAL 8002 **802**
MAT **H02** | SOFT **S82**



RAL 8015 **815**
MAT **H15** | SOFT **R85**



RAL 8028 **828**
MAT **H28** | SOFT **R88**

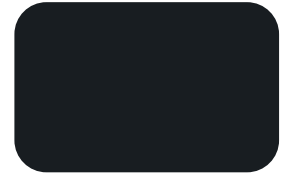

RAL 9011 **911**
MAT **9R1** | SOFT **R91**

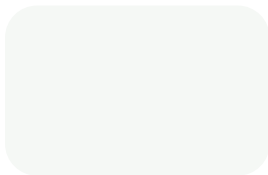

RAL 9016 **916**
MAT **J16** | SOFT **S96**



RAL 9017 **917**
MAT **M17** | SOFT **R97**



RAL 9018 **918**
MAT **I18** | SOFT **S98**

Každý výrobek s práškovým nástřikem v barvě z palety RAL dostupné v paletě Terma je k dispozici ve verzích SOFT a MAT.

Některé barvy RAL jsou ve VZORNÍKU SPECIÁLNÍCH BAREV označeny jako MATT (polomat) nebo SOFT (mat) a lze je objednat přímo jako polomatné nebo matné.

Všechny ostatní barvy RAL si můžete také objednat jako MATT (30% lesku), nebo SOFT (10% lesku) s příplatkem 25%, neboť mají jednu zmatňující vrstvu navíc.

MODELY SKLADEM

Radiátory, které potřebujete ihned můžete vybírat ze skladu TERMA pro ČR a SR.

Objednávky přijaté v režimu ceny EXW do 12h budou ještě ten den ze skladu TERMA pro ČR a SR expedovány a doručení záleží od rychlosti přepravce, standardně den odeslání + 24hodin.

Dostupnost na www stránkách je online a standardně vždy do Vyprodání zásob k dispozici na skladě TERMA pro ČR a SR.

Mimo dále prezentovaný již jen sklad TERMA pro ČR a SR, můžete ověřovat dostupnost skladových výrobků z CENTRÁLNÍHO SKLADU TERMA na en.termagroup.com.

Objednávky přijaté na CENTRÁLNÍ SKLAD TERMA do 12h budou ještě ten den expedovány a doručení záleží od rychlosti přepravce, standardně den odeslání + 3dny.

ZASÍLÁNÍ OBJEDNÁVEK

Terma velmi ráda vyrobí dle vaší z katalogu navolené konfigurace jednotkové objednávky radiátorů na zakázku. Tzn. pokud se koncový zákazník nechce omezovat skladovými rychle dodanými modely, nakonfigurujte s ním jakýkoliv radiátor v libovolných 650 barvách podle přání a my jej na zakázku vyrobíme.

Objednávejte prosím své objednávky takto:

1. Radiátory na zakázku / Atypické radiátory / Výrobky z CENTRÁLNÍHO SKLADU TERMA:

Objednávejte na: orders-heating@termagroup.pl

K objednávkám Atypických radiátorů vždy přikládejte i Cenovou nabídku od Regionálního Managera.

Do objednávek Výrobků z CENTRÁLNÍHO SKLADU TERMA vždy viditelně dopište „Z MAGAZYNU“, jinak automaticky budeme objednané zboží znovu vyrábět a budete čekat než bude vyrobeno.

2. Radiátory SKLADEM (sklad TERMA pro ČR a SR provozuje Dobráklíma, s.r.o., Bratislava):

Ověření aktuálních zásob skladových modelů:
www.dobraklima.sk/dizajnov-e-radiatory-skladom, případně obchodník +421 905 412 770

Objednávejte na: info@dobraklima.sk

Do objednávky dopište „ZE SKLADU“

Upozorňujeme: Pokud se spolu s Vaší objednávkou sejde příliš mnoho objednávek, může dojít k vyčerpání skladových zásob vybraného rozměru a budete upozorněni na datum, kdy budou z produkce tyto radiátory znovu na sklad dodány. Zákazník si může samozřejmě zvolit jiný rozměr, barvu, model nebo si nechat vyrobit radiátor na zakázku jako v možnosti 1.



SADA OBSAHUJE:

Radiátor je prodáván v ceně spolu se třemi redukcemi, jednou euro zátkou, odvzdušňovacím ventilem, háky do zdi a stěhovacími pásy.

DOPORUČUJEME PRO PŘIPOJENÍ LP:



Sada rohová regulační "Mini-malist"

TGZR017: 228 EUR

Stránka: 308

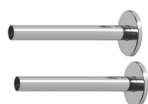

Sada krycí dvojitá, Chrom

TGPCR004: 33 EUR

Stránka: 310

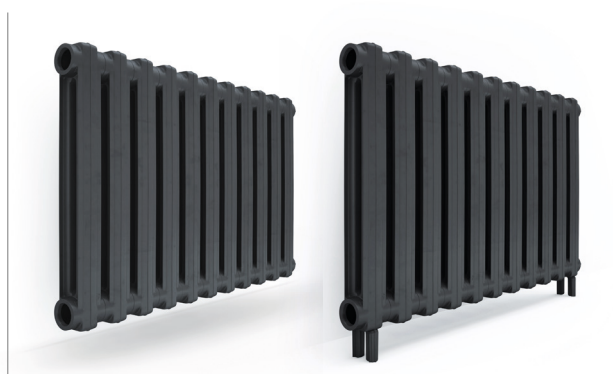

SKUPINY BAREV A VYKONČENÍ:

Skupina 1 – Raw Metal, Metal Alive, 190 barev RAL, White Soft, Frost, Metallic Brown, Autumn, Evening Garden, Shadow Gold, Graff i Flat Black

Skupina 2 – Full Burnish, Shaded Burnish, Antique Brass, Antique Copper, Bottle Green, Red Wine, Midnight

Skupina 3 – Ornament Gold, Ornament Silver, Ornament Copper, Galvanic Copper, Polished Metal

RADIÁTOR VODNÍ:

Připojení:



V tabulkách jsou pouze ukázkové sady do 17 článků. Lze objednat delší radiátory.

Radiátor nad 13 článků je dodáván ve dvou nebo více sestavách.

↔ [mm]	75/65/20°C [W]	55/45/20°C [W]	Počet článků	Skupina 1 Cena bez DPH [EUR]	Skupina 2 Cena bez DPH [EUR]	Skupina 3 Cena bez DPH [EUR]	Kód produktu ... Kód konfigurace s. 363
580 ⇄ [mm] – Verze nástěnná							
80	73	39	1	114	132	165	WGBRB058008...
278	218	116	3	342	396	495	WGBRB058027...
360	291	154	4	456	528	660	WGBRB058036...
442	364	193	5	570	660	825	WGBRB058044...
524	436	232	6	684	792	990	WGBRB058052...
606	509	270	7	798	924	1 155	WGBRB058060...
688	582	309	8	912	1056	1320	WGBRB058068...
770	654	347	9	1 026	1 188	1 485	WGBRB058077...
852	727	386	10	1 140	1 320	1 650	WGBRB058085...
934	800	425	11	1 254	1 452	1 815	WGBRB058093...
1016	872	463	12	1 368	1 584	1 980	WGBRB058101...
1098	945	502	13	1 482	1 716	2 145	WGBRB058109...
1180	1018	540	14	1 596	1 848	2 310	WGBRB058118...

↔ [mm]	75/65/20°C [W]	55/45/20°C [W]	Počet článků	Skupina 1 Cena bez DPH [EUR]	Skupina 2 Cena bez DPH [EUR]	Skupina 3 Cena bez DPH [EUR]	Kód produktu ... Kód konfigurace s. 363
1262	1091	579	15	1 710	1 980	2 475	WGBRB058126...
1344	1163	618	16	1 824	2 112	2 640	WGBRB058134...
1426	1236	656	17	1 938	2 244	2 805	WGBRB058142...

640 ⇅ [mm] – Verze s nožkami

80	73	39	1	114	132	165	WGBRF064008...
278	218	116	3	342	396	495	WGBRF064027...
360	291	154	4	456	528	660	WGBRF064036...
442	364	193	5	570	660	825	WGBRF064044...
524	436	232	6	684	792	990	WGBRF064052...
606	509	270	7	798	924	1 155	WGBRF064060...
688	582	309	8	912	1056	1320	WGBRF064068...
770	654	347	9	1 026	1 188	1 485	WGBRF064077...
852	727	386	10	1 140	1 320	1 650	WGBRF064085...
934	800	425	11	1 254	1 452	1 815	WGBRF064093...
1016	872	463	12	1 368	1 584	1 980	WGBRF064101...
1098	945	502	13	1 482	1 716	2 145	WGBRF064109...
1180	1018	540	14	1 596	1 848	2 310	WGBRF064118...
1262	1091	579	15	1 710	1 980	2 475	WGBRF064126...
1344	1163	618	16	1 824	2 112	2 640	WGBRF064134...
1426	1236	656	17	1 938	2 244	2 805	WGBRF064142...



SADA OBSAHUJE:

Radiátor je prodáván v ceně spolu se třemi redukcemi, jednou euro zátkou, odvzdušňovacím ventilem, háky do zdi a stěhovacími pásy.

DOPORUČUJEME PRO PŘIPOJENÍ LP:



Sada rohová regulační „Classic Art”

– antracit

TGERANT01: 199 EUR

Stránka: 308



Sada krycí dvojitá „Artistic”

– Antracit

TGPAN001: 64 EUR

Stránka: 310

RADIÁTOR VODNÍ:

Připojení:



V tabulkách jsou pouze ukázkové sady do 17 článků. Lze objednat delší radiátory. Radiátor nad 13 článků je dodáván ve dvou nebo více sestavách.



SKUPINY BAREV A VYKONČENÍ:

Skupina 1 – Raw Metal, Metal Alive, 190 barev RAL, White Soft, Frost, Metallic Brown, Autumn, Evening Garden, Shadow Gold, Graff i Flat Black

Skupina 2 – Full Burnish, Shaded Burnish, Antique Brass, Antique Copper, Bottle Green, Red Wine, Midnight

Skupina 3 – Ornament Gold, Ornament Silver, Ornament Copper, Galvanic Copper, Polished Metal

↔ [mm]	75/65/20°C [W]	55/45/20°C [W]	Počet článků	Skupina 1 Cena bez DPH [EUR]	Skupina 2 Cena bez DPH [EUR]	Skupina 3 Cena bez DPH [EUR]	Kód produktu ... Kód konfigurace s. 363
460 ⇄ [mm] – Verze nástěnná							
80	87	46	1	149	175	217	WGKAB046008...
278	259	137	3	447	525	651	WGKAB046027...
360	346	183	4	596	700	868	WGKAB046036...
442	432	228	5	745	875	1 085	WGKAB046044...
524	518	274	6	894	1 050	1 302	WGKAB046052...
606	605	320	7	1 043	1 225	1 519	WGKAB046060...
688	691	365	8	1192	1400	1736	WGKAB046068...
770	777	411	9	1 341	1 575	1 953	WGKAB04607...
852	863	457	10	1 490	1 750	2 170	WGKAB046085...
934	950	502	11	1 639	1 925	2 387	WGKAB046093...
1016	1036	548	12	1 788	2 100	2 604	WGKAB046101...
1098	1122	594	13	1 937	2 275	2 821	WGKAB046109...
1180	1209	640	14	2 086	2 450	3 038	WGKAB046118...
1262	1295	685	15	2 235	2 625	3 255	WGKAB046126...

↔ [mm]	75/65/20°C [W]	55/45/20°C [W]	Počet článků	Skupina 1 Cena bez DPH [EUR]	Skupina 2 Cena bez DPH [EUR]	Skupina 3 Cena bez DPH [EUR]	Kód produktu ... Kód konfigurace s. 363
1344	1381	731	16	2 384	2 800	3 472	WGKAB046134...
1426	1468	777	17	2 533	2 975	3 689	WGKAB046142...

660 ⇅ [mm] – Verze nástěnná

80	120	65	1	196	228	288	WGKAB066008...
278	361	195	3	588	684	864	WGKAB066027...
360	481	260	4	784	912	1 152	WGKAB066036...
442	602	325	5	980	1 140	1 440	WGKAB066044...
524	722	391	6	1 176	1 368	1 728	WGKAB066052...
606	842	456	7	1 372	1 596	2 016	WGKAB066060...
688	962	521	8	1568	1824	2304	WGKAB066068...
770	1083	586	9	1 764	2 052	2 592	WGKAB066077...
852	1203	651	10	1 960	2 280	2 880	WGKAB066085...
934	1323	716	11	2 156	2 508	3 168	WGKAB066093...
1016	1444	781	12	2 352	2 736	3 456	WGKAB066101...
1098	1564	846	13	2 548	2 964	3 744	WGKAB066109...
1180	1684	911	14	2 744	3 192	4 032	WGKAB066118...
1262	1805	976	15	2 940	3 420	4 320	WGKAB066126...
1344	1925	1041	16	3 136	3 648	4 608	WGKAB066134...
1426	2045	1107	17	3 332	3 876	4 896	WGKAB066142...

860 ⇅ [mm] – Verze nástěnná

80	120	65	1	254	296	393	WGKAB086008...
278	361	195	3	762	888	1 179	WGKAB086027...
360	481	260	4	1 016	1 184	1 572	WGKAB086036...
442	602	325	5	1 270	1 480	1 965	WGKAB086044...
524	722	391	6	1 524	1 776	2 358	WGKAB086052...
606	842	456	7	1 778	2 072	2 751	WGKAB086060...
688	962	521	8	2032	2368	3144	WGKAB086068...
770	1083	586	9	2 286	2 664	3 537	WGKAB086077...
852	1203	651	10	2 540	2 960	3 930	WGKAB086085...
934	1323	716	11	2 794	3 256	4 323	WGKAB086093...
1016	1444	781	12	3 048	3 552	4 716	WGKAB086101...
1098	1564	846	13	3 302	3 848	5 109	WGKAB086109...
1180	1684	911	14	3 556	4 144	5 502	WGKAB086118...
1262	1805	976	15	3 810	4 440	5 895	WGKAB086126...
1344	1925	1041	16	4 064	4 736	6 288	WGKAB086134...
1426	2045	1107	17	4 318	5 032	6 681	WGKAB086142...

↔ [mm]	75/65/20°C [W]	55/45/20°C [W]	Počet článků	Skupina1 Cena bez DPH [EUR]	Skupina2 Cena bez DPH [EUR]	Skupina3 Cena bez DPH [EUR]	Kód produktu ... Kód konfigurace s. 308
520 ⇄ [mm] – Verze s nožkami							
80	120	65	1	149	175	217	WGKAF052008...
278	361	195	3	447	525	651	WGKAF052027...
360	481	260	4	596	700	868	WGKAF052036...
442	602	325	5	745	875	1 085	WGKAF052044...
524	722	391	6	894	1 050	1 302	WGKAF052052...
606	842	456	7	1 043	1 225	1 519	WGKAF052060...
688	962	521	8	1192	1400	1736	WGKAF052068...
770	1083	586	9	1 341	1 575	1 953	WGKAF052077...
852	1203	651	10	1 490	1 750	2 170	WGKAF052085...
934	1323	716	11	1 639	1 925	2 387	WGKAF052093...
1016	1444	781	12	1 788	2 100	2 604	WGKAF052101...
1098	1564	846	13	1 937	2 275	2 821	WGKAF052109...
1180	1684	911	14	2 086	2 450	3 038	WGKAF052118...
1262	1805	976	15	2 235	2 625	3 255	WGKAF052126...
1344	1925	1041	16	2 384	2 800	3 472	WGKAF052134...
1426	2045	1107	17	2 533	2 975	3 689	WGKAF052142...
720 ⇄ [mm] – Verze s nožkami							
80	120	65	1	196	228	288	WGKAF072008...
278	361	195	3	588	684	864	WGKAF072027...
360	481	260	4	784	912	1 152	WGKAF072036...
442	602	325	5	980	1 140	1 440	WGKAF072044...
524	722	391	6	1 176	1 368	1 728	WGKAF072052...
606	842	456	7	1 372	1 596	2 016	WGKAF072060...
688	962	521	8	1568	1824	2304	WGKAF072068...
770	1083	586	9	1 764	2 052	2 592	WGKAF072077...
852	1203	651	10	1 960	2 280	2 880	WGKAF072085...
934	1323	716	11	2 156	2 508	3 168	WGKAF072093...
1016	1444	781	12	2 352	2 736	3 456	WGKAF072101...
1098	1564	846	13	2 548	2 964	3 744	WGKAF072109...
1180	1684	911	14	2 744	3 192	4 032	WGKAF072118...
1262	1805	976	15	2 940	3 420	4 320	WGKAF072126...
1344	1925	1041	16	3 136	3 648	4 608	WGKAF072134...
1426	2045	1107	17	3 332	3 876	4 896	WGKAF072142...

↔ [mm]	75/65/20°C [W]	55/45/20°C [W]	Počet článků	Skupina1 Cena bez DPH [EUR]	Skupina2 Cena bez DPH [EUR]	Skupina3 Cena bez DPH [EUR]	Kód produktu ... Kód konfigurace s.308
920 ⇄[mm] – Verze s nožkami							
80	120	65	1	254	296	393	WGKAF092008...
278	361	195	3	762	888	1 179	WGKAF092027...
360	481	260	4	1 016	1 184	1 572	WGKAF092036...
442	602	325	5	1 270	1 480	1 965	WGKAF092044...
524	722	391	6	1 524	1 776	2 358	WGKAF092052...
606	842	456	7	1 778	2 072	2 751	WGKAF092060...
688	962	521	8	2032	2368	3144	WGKAF092068...
770	1083	586	9	2 286	2 664	3 537	WGKAF092077...
852	1203	651	10	2 540	2 960	3 930	WGKAF092085...
934	1323	716	11	2 794	3 256	4 323	WGKAF092093...
1016	1444	781	12	3 048	3 552	4 716	WGKAF092101...
1098	1564	846	13	3 302	3 848	5 109	WGKAF092109...
1180	1684	911	14	3 556	4 144	5 502	WGKAF092118...
1262	1805	976	15	3 810	4 440	5 895	WGKAF092126...
1344	1925	1041	16	4 064	4 736	6 288	WGKAF092134...
1426	2045	1107	17	4 318	5 032	6 681	WGKAF092142...



SADA OBSAHUJE:

Radiátor je prodáván v ceně spolu se třemi redukcemi, jednou euro zátkou, odvzdušňovacím ventilem, háky do zdi a stěhovacími pásy.

DOPORUČUJEME PRO PŘIPOJENÍ LP:



Sada regulační termostatická „Artistic“ – Antracit

TGETAN002: 190 EUR

Stránka: 309



Sada krycí dvojitá „Artistic“ – Antracit

TGPAN001: 64 EUR

Stránka: 310

RADIÁTOR VODNÍ:

Připojení:



SKUPINY BAREV A VYKONČENÍ:

Skupina 1 – Raw Metal, Metal Alive, 190 barev RAL, White Soft, Frost, Metallic Brown, Autumn, Evening Garden, Shadow Gold, Graff i Flat Black

Skupina 2 – Full Burnish, Shaded Burnish, Antique Brass, Antique Copper, Bottle Green, Red Wine, Midnight

Skupina 3 – Ornament Gold, Ornament Silver, Ornament Copper, Galvanic Copper, Polished Metal

V tabulkách jsou pouze ukázkové sady do 17 článků. Lze objednat delší radiátory. Radiátor nad 13 článků je dodáván ve dvou nebo více sestavách.

↔ [mm]	75/65/20°C [W]	55/45/20°C [W]	Počet článků	Skupina 1 Cena bez DPH [EUR]	Skupina 2 Cena bez DPH [EUR]	Skupina 3 Cena bez DPH [EUR]	Kód produktu ... Kód konfigurace s. 363
410 ⇄ [mm] – Verze nástěnná							
80	86	44	1	147	162	206	WGOXB041008...
278	257	133	3	441	486	618	WGOXB041027...
360	343	177	4	588	648	824	WGOXB041036...
442	429	222	5	735	810	1 030	WGOXB041044...
524	515	266	6	882	972	1 236	WGOXB041052...
606	601	310	7	1 029	1 134	1 442	WGOXB041060...
688	686	355	8	1 176	1 296	1 648	WGOXB041068...
770	772	399	9	1 323	1 458	1 854	WGOXB041077...
852	858	443	10	1 470	1 620	2 060	WGOXB041085...
934	944	488	11	1 617	1 782	2 266	WGOXB041093...
1016	1030	532	12	1 764	1 944	2 472	WGOXB041101...
1098	1115	577	13	1 911	2 106	2 678	WGOXB041109...
1180	1201	621	14	2 058	2 268	2 884	WGOXB041118...
1262	1287	665	15	2 205	2 430	3 090	WGOXB041126...
1344	1373	710	16	2 352	2 592	3 296	WGOXB041134...
1426	1459	754	17	2 499	2 754	3 502	WGOXB041142...

↔ [mm]	75/65/20°C [W]	55/45/20°C [W]	Počet článků	Skupina 1 Cena bez DPH [EUR]	Skupina 2 Cena bez DPH [EUR]	Skupina 3 Cena bez DPH [EUR]	Kód produktu ... Kód konfigurace s. 363
470 ⇄ [mm] – Verze s nožkami							
80	86	44	1	147	162	206	WGOXF047008...
278	257	133	3	441	486	618	WGOXF047027...
360	343	177	4	588	648	824	WGOXF047036...
442	429	222	5	735	810	1 030	WGOXF047044...
524	515	266	6	882	972	1 236	WGOXF047052...
606	601	310	7	1 029	1 134	1 442	WGOXF047060...
688	686	355	8	1176	1296	1648	WGOXF047068...
770	772	399	9	1 323	1 458	1 854	WGOXF047077...
852	858	443	10	1 470	1 620	2 060	WGOXF047085...
934	944	488	11	1 617	1 782	2 266	WGOXF047093...
1016	1030	532	12	1 764	1 944	2 472	WGOXF047101...
1098	1115	577	13	1 911	2 106	2 678	WGOXF047109...
1180	1201	621	14	2 058	2 268	2 884	WGOXF047118...
1262	1287	665	15	2 205	2 430	3 090	WGOXF047126...
1344	1373	710	16	2 352	2 592	3 296	WGOXF047134...
1426	1459	754	17	2 499	2 754	3 502	WGOXF047142...
660 ⇄ [mm] – Verze nástěnná							
80	143	76	1	195	218	278	WGOXB066008...
278	429	227	3	585	654	834	WGOXB066027...
360	572	303	4	780	872	1 112	WGOXB066036...
442	715	379	5	975	1 090	1 390	WGOXB066044...
524	858	454	6	1 170	1 308	1 668	WGOXB066052...
606	1001	530	7	1 365	1 526	1 946	WGOXB066060...
688	1144	606	8	1560	1744	2224	WGOXB066068...
770	1287	682	9	1 755	1 962	2 502	WGOXB066077...
852	1430	757	10	1 950	2 180	2 780	WGOXB066085...
934	1573	833	11	2 145	2 398	3 058	WGOXB066093...
1016	1716	909	12	2 340	2 616	3 336	WGOXB066101...
1098	1859	985	13	2 535	2 834	3 614	WGOXB066109...
1180	2002	1060	14	2 730	3 052	3 892	WGOXB066118...
1262	2145	1136	15	2 925	3 270	4 170	WGOXB066126...
1344	2288	1212	16	3 120	3 488	4 448	WGOXB066134...
1426	2431	1288	17	3 315	3 706	4 726	WGOXB066142...

↔ [mm]	75/65/20°C [W]	55/45/20°C [W]	Počet článků	Skupina 1 Cena bez DPH [EUR]	Skupina 2 Cena bez DPH [EUR]	Skupina 3 Cena bez DPH [EUR]	Kód produktu ... Kód konfigurace s.363
710 ⇄ [mm] – Verze s nožkami							
80	143	76	1	195	218	278	WGOXF071008...
278	429	227	3	585	654	834	WGOXF071027...
360	572	303	4	780	872	1 112	WGOXF071036...
442	715	379	5	975	1 090	1 390	WGOXF071044...
524	858	454	6	1 170	1 308	1 668	WGOXF071052...
606	1001	530	7	1 365	1 526	1 946	WGOXF071060...
688	1144	606	8	1560	1744	2224	WGOXF071068...
770	1287	682	9	1 755	1 962	2 502	WGOXF071077...
852	1430	757	10	1 950	2 180	2 780	WGOXF071085...
934	1573	833	11	2 145	2 398	3 058	WGOXF071093...
1016	1716	909	12	2 340	2 616	3 336	WGOXF071101...
1098	1859	985	13	2 535	2 834	3 614	WGOXF071109...
1180	2002	1060	14	2 730	3 052	3 892	WGOXF071118...
1262	2145	1136	15	2 925	3 270	4 170	WGOXF071126...
1344	2288	1212	16	3 120	3 488	4 448	WGOXF071134...
1426	2431	1288	17	3 315	3 706	4 726	WGOXF071142...

Plain



SADA OBSAHUJE:

Radiátor je prodáván v ceně spolu se třemi redukcemi, jednou euro zátkou, odvzdušňovacím ventilem, háky do zdi a stěhovacími pásy.

DOPORUČUJEME PRO PŘIPOJENÍ LP:



Sada rohová regulační

"Minimalist", Chrom

TGZRCR017: 228 EUR

Stránka: 308

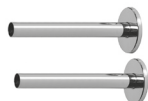

Sada krycí dvojitá, Chrom

TGPCR004: 33 EUR

Stránka: 310



SKUPINY BAREV A VYKONČENÍ:

Skupina 1 – Raw Metal, Metal Alive, 190 barev RAL, White Soft, Frost, Metallic Brown, Autumn, Evening Garden, Shadow Gold, Graff i Flat Black

Skupina 2 – Full Burnish, Shaded Burnish, Antique Brass, Antique Copper, Bottle Green, Red Wine, Midnight

Skupina 3 – Ornament Gold, Ornament Silver, Ornament Copper, Galvanic Copper, Polished Metal

RADIÁTOR VODNÍ:

Připojení:



V tabulkách jsou pouze ukázkové sady do 17 článků. Lze objednat delší radiátory.

Radiátor nad 13 článků je dodáván ve dvou nebo více sestavách.

↔ [mm]	75/65/20°C [W]	55/45/20°C [W]	Počet článků	Skupina 1 Cena bez DPH [EUR]	Skupina 2 Cena bez DPH [EUR]	Skupina 3 Cena bez DPH [EUR]	Kód produktu ... Kód konfigurace s. 363
460 ⇄ [mm] – Verze nástěnná							
80	86	46	1	138	159	198	WGPLB046008...
278	259	137	3	414	477	594	WGPLB046027...
360	345	183	4	552	636	792	WGPLB046036...
442	432	228	5	690	795	990	WGPLB046044...
524	518	274	6	828	954	1 188	WGPLB046052...
606	604	320	7	966	1 113	1 386	WGPLB046060...
688	690	365	8	1104	1272	1584	WGPLB046068...
770	777	411	9	1 242	1 431	1 782	WGPLB046077...
852	863	457	10	1 380	1 590	1 980	WGPLB046085...
934	949	503	11	1 518	1 749	2 178	WGPLB046093...
1016	1036	548	12	1 656	1 908	2 376	WGPLB046101...
1098	1122	594	13	1 794	2 067	2 574	WGPLB046109...
1180	1208	640	14	1 932	2 226	2 772	WGPLB046118...
1262	1295	685	15	2 070	2 385	2 970	WGPLB046126...
1344	1381	731	16	2 208	2 544	3 168	WGPLB046134...
1426	1467	777	17	2 346	2 703	3 366	WGPLB046142...

↔ [mm]	75/65/20°C [W]	55/45/20°C [W]	Počet článků	Skupina 1 Cena bez DPH [EUR]	Skupina 2 Cena bez DPH [EUR]	Skupina 3 Cena bez DPH [EUR]	Kód produktu ... Kód konfigurace s. 363
520 ⇄ [mm] – Verze s nožkami							
80	86	46	1	138	159	198	WGPLF052008...
278	259	137	3	414	477	594	WGPLF052027...
360	345	183	4	552	636	792	WGPLF052036...
442	432	228	5	690	795	990	WGPLF052044...
524	518	274	6	828	954	1 188	WGPLF052052...
606	604	320	7	966	1 113	1 386	WGPLF052060...
688	690	365	8	1104	1272	1584	WGPLF052068...
770	777	411	9	1 242	1 431	1 782	WGPLF052077...
852	863	457	10	1 380	1 590	1 980	WGPLF052085...
934	949	503	11	1 518	1 749	2 178	WGPLF052093...
1016	1036	548	12	1 656	1 908	2 376	WGPLF052101...
1098	1122	594	13	1 794	2 067	2 574	WGPLF052109...
1180	1208	640	14	1 932	2 226	2 772	WGPLF052118...
1262	1295	685	15	2 070	2 385	2 970	WGPLF052126...
1344	1381	731	16	2 208	2 544	3 168	WGPLF052134...
1426	1467	777	17	2 346	2 703	3 366	WGPLF052142...
560 ⇄ [mm] – Verze nástěnná							
80	103	54	1	147	170	226	WGPLB056008...
278	308	163	3	441	510	678	WGPLB056027...
360	410	217	4	588	680	904	WGPLB056036...
442	513	271	5	735	850	1 130	WGPLB056044...
524	615	325	6	882	1 020	1 356	WGPLB056052...
606	718	379	7	1 029	1 190	1 582	WGPLB056060...
688	820	434	8	1176	1360	1808	WGPLB056068...
770	923	488	9	1 323	1 530	2 034	WGPLB056077...
852	1025	542	10	1 470	1 700	2 260	WGPLB056085...
934	1128	596	11	1 617	1 870	2 486	WGPLB056093...
1016	1230	650	12	1 764	2 040	2 712	WGPLB056101...
1098	1333	705	13	1 911	2 210	2 938	WGPLB056109...
1180	1435	759	14	2 058	2 380	3 164	WGPLB056118...
1262	1538	813	15	2 205	2 550	3 390	WGPLB056126...
1344	1640	867	16	2 352	2 720	3 616	WGPLB056134...
1426	1743	921	17	2 499	2 890	3 842	WGPLB056142...
620 ⇄ [mm] – Verze s nožkami							
80	103	54	1	147	170	226	WGPLF062008...
278	308	163	3	441	510	678	WGPLF062027...
360	410	217	4	588	680	904	WGPLF062036...
442	513	271	5	735	850	1 130	WGPLF062044...
524	615	325	6	882	1 020	1 356	WGPLF062052...
606	718	379	7	1 029	1 190	1 582	WGPLF062060...
688	820	434	8	1176	1360	1808	WGPLF062068...
770	923	488	9	1 323	1 530	2 034	WGPLF062077...

↔ [mm]	75/65/20°C [W]	55/45/20°C [W]	Počet článků	Skupina 1 Cena bez DPH [EUR]	Skupina 2 Cena bez DPH [EUR]	Skupina 3 Cena bez DPH [EUR]	Kód produktu ... Kód konfigurace s. 363
852	1025	542	10	1 470	1 700	2 260	WGPLF062085...
934	1128	596	11	1 617	1 870	2 486	WGPLF062093...
1016	1230	650	12	1 764	2 040	2 712	WGPLF062101...
1098	1333	705	13	1 911	2 210	2 938	WGPLF062109...
1180	1435	759	14	2 058	2 380	3 164	WGPLF062118...
1262	1538	813	15	2 205	2 550	3 390	WGPLF062126...
1344	1640	867	16	2 352	2 720	3 616	WGPLF062134...
1426	1743	921	17	2 499	2 890	3 842	WGPLF062142...

660 ⇅ [mm] – Verze nástěnná

80	124	66	1	159	182	237	WGPLB066008...
278	372	198	3	477	546	711	WGPLB066027...
360	496	265	4	636	728	948	WGPLB066036...
442	620	331	5	795	910	1 185	WGPLB066044...
524	744	397	6	954	1 092	1 422	WGPLB066052...
606	868	463	7	1 113	1 274	1 659	WGPLB066060...
688	992	529	8	1 272	1 456	1 896	WGPLB066068...
770	1 116	595	9	1 431	1 638	2 133	WGPLB066077...
852	1 240	661	10	1 590	1 820	2 370	WGPLB066085...
934	1 364	728	11	1 749	2 002	2 607	WGPLB066093...
1 016	1 488	794	12	1 908	2 184	2 844	WGPLB066101...
1 098	1 612	860	13	2 067	2 366	3 081	WGPLB066109...
1 180	1 736	926	14	2 226	2 548	3 318	WGPLB066118...
1 262	1 860	992	15	2 385	2 730	3 555	WGPLB066126...
1 344	1 984	1 058	16	2 544	2 912	3 792	WGPLB066134...
1 426	2 108	1 124	17	2 703	3 094	4 029	WGPLB066142...

720 ⇅ [mm] – Verze s nožkami

80	124	66	1	159	182	237	WGPLF072008...
278	372	198	3	477	546	711	WGPLF072027...
360	496	265	4	636	728	948	WGPLF072036...
442	620	331	5	795	910	1 185	WGPLF072044...
524	744	397	6	954	1 092	1 422	WGPLF072052...
606	868	463	7	1 113	1 274	1 659	WGPLF072060...
688	992	529	8	1 272	1 456	1 896	WGPLF072068...
770	1 116	595	9	1 431	1 638	2 133	WGPLF072077...
852	1 240	661	10	1 590	1 820	2 370	WGPLF072085...
934	1 364	728	11	1 749	2 002	2 607	WGPLF072093...
1 016	1 488	794	12	1 908	2 184	2 844	WGPLF072101...
1 098	1 612	860	13	2 067	2 366	3 081	WGPLF072109...
1 180	1 736	926	14	2 226	2 548	3 318	WGPLF072118...
1 262	1 860	992	15	2 385	2 730	3 555	WGPLF072126...
1 344	1 984	1 058	16	2 544	2 912	3 792	WGPLF072134...
1 426	2 108	1 124	17	2 703	3 094	4 029	WGPLF072142...

↔ [mm]	75/65/20°C [W]	55/45/20°C [W]	Počet článků	Skupina 1 Cena bez DPH [EUR]	Skupina 2 Cena bez DPH [EUR]	Skupina 3 Cena bez DPH [EUR]	Kód produktu ... Kód konfigurace s. 363
860 ⇄ [mm] – Verze nástěnná							
80	161	86	1	177	207	269	WGPLB086008...
278	483	258	3	531	621	807	WGPLB086027...
360	644	344	4	708	828	1 076	WGPLB086036...
442	805	429	5	885	1 035	1 345	WGPLB086044...
524	966	515	6	1 062	1 242	1 614	WGPLB086052...
606	1127	601	7	1 239	1 449	1 883	WGPLB086060...
688	1288	687	8	1416	1656	2152	WGPLB086068...
770	1449	773	9	1 593	1 863	2 421	WGPLB086077...
852	1610	859	10	1 770	2 070	2 690	WGPLB086085...
934	1771	945	11	1 947	2 277	2 959	WGPLB086093...
1016	1932	1031	12	2 124	2 484	3 228	WGPLB086101...
1098	2093	1116	13	2 301	2 691	3 497	WGPLB086109...
1180	2254	1202	14	2 478	2 898	3 766	WGPLB086118...
1262	2415	1288	15	2 655	3 105	4 035	WGPLB086126...
1344	2576	1374	16	2 832	3 312	4 304	WGPLB086134...
1426	2737	1460	17	3 009	3 519	4 573	WGPLB086142...

920 ⇄ [mm] – Verze s nožkami

80	161	86	1	177	207	269	WGPLF092008...
278	483	258	3	531	621	807	WGPLF092027...
360	644	344	4	708	828	1 076	WGPLF092036...
442	805	429	5	885	1 035	1 345	WGPLF092044...
524	966	515	6	1 062	1 242	1 614	WGPLF092052...
606	1127	601	7	1 239	1 449	1 883	WGPLF092060...
688	1288	687	8	1416	1656	2152	WGPLF092068...
770	1449	773	9	1 593	1 863	2 421	WGPLF092077...
852	1610	859	10	1 770	2 070	2 690	WGPLF092085...
934	1771	945	11	1 947	2 277	2 959	WGPLF092093...
1016	1932	1031	12	2 124	2 484	3 228	WGPLF092101...
1098	2093	1116	13	2 301	2 691	3 497	WGPLF092109...
1180	2254	1202	14	2 478	2 898	3 766	WGPLF092118...
1262	2415	1288	15	2 655	3 105	4 035	WGPLF092126...
1344	2576	1374	16	2 832	3 312	4 304	WGPLF092134...
1426	2737	1460	17	3 009	3 519	4 573	WGPLF092142...

Plain 3K



SADA OBSAHUJE:

Radiátor je prodáván v ceně spolu se třemi redukcemi, jednou euro zátkou, odvzdušňovacím ventilem, háky do zdi a stěhovacími pásy.

DOPORUČUJEME PRO PŘIPOJENÍ LP:



Sada rohová regulační
"Minimalist", Chrom
TGZRCR017: 228 EUR
Stránka: 308

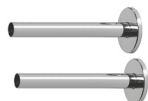

Sada krycí dvojité, Chrom
TGPCR004: 33 EUR
Stránka: 310

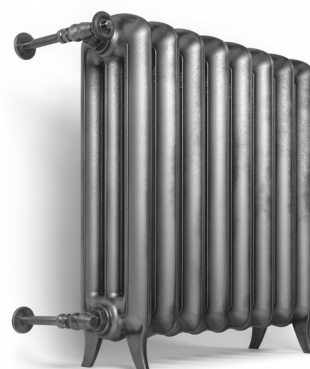

RADIÁTOR VODNÍ:

Připojení:



SKUPINY BAREV A VYKONČENÍ:

Skupina 1 – Raw Metal, Metal Alive, 190 barev RAL, White Soft, Frost, Metallic Brown, Autumn, Evening Garden, Shadow Gold, Graff i Flat Black

Skupina 2 – Full Burnish, Shaded Burnish, Antique Brass, Antique Copper, Bottle Green, Red Wine, Midnight

Skupina 3 – Ornament Gold, Ornament Silver, Ornament Copper, Galvanic Copper, Polished Metal

V tabulkách jsou pouze ukázkové sady do 17 článků. Lze objednat delší radiátory. Radiátor nad 13 článků je dodáván ve dvou nebo více sestavách.

↔ [mm]	75/65/20°C [W]	55/45/20°C [W]	Počet článků	Skupina 1 Cena bez DPH [EUR]	Skupina 2 Cena bez DPH [EUR]	Skupina 3 Cena bez DPH [EUR]	Kód produktu ... Kód konfigurace s. 363
460 ⇅ [mm] – Verze nástěnná NOVINKA							
80	97	50	1	159	192	230	WGP3B046008...
278	290	151	3	477	576	690	WGP3B046027...
360	386	201	4	636	768	920	WGP3B046036...
442	483	251	5	795	960	1 150	WGP3B046044...
524	580	301	6	954	1 152	1 380	WGP3B046052...
606	676	351	7	1 113	1 344	1 610	WGP3B046060...
688	773	402	8	1 272	1 536	1 840	WGP3B046068...
770	869	452	9	1 431	1 728	2 070	WGP3B046077...
852	966	502	10	1 590	1 920	2 300	WGP3B046085...
934	1 063	552	11	1 749	2 112	2 530	WGP3B046093...
1 016	1 159	602	12	1 908	2 304	2 760	WGP3B046101...
1 098	1 256	653	13	2 067	2 496	2 990	WGP3B046109...
1 180	1 352	703	14	2 226	2 688	3 220	WGP3B046118...
1 262	1 449	753	15	2 385	2 880	3 450	WGP3B046126...
1 344	1 546	803	16	2 544	3 072	3 680	WGP3B046134...
1 426	1 642	853	17	2 703	3 264	3 910	WGP3B046142...

↔ [mm]	75/65/20°C [W]	55/45/20°C [W]	Počet článků	Skupina 1 Cena bez DPH [EUR]	Skupina 2 Cena bez DPH [EUR]	Skupina 3 Cena bez DPH [EUR]	Kód produktu ... Kód konfigurace s. 363
520 ⇅ [mm] – Verze s nožkami NOVINKA							
80	97	50	1	159	192	230	WGP3F052008...
278	290	151	3	477	576	690	WGP3F052027...
360	386	201	4	636	768	920	WGP3F052036...
442	483	251	5	795	960	1 150	WGP3F052044...
524	580	301	6	954	1 152	1 380	WGP3F052052...
606	676	351	7	1 113	1 344	1 610	WGP3F052060...
688	773	402	8	1 272	1 536	1 840	WGP3F052068...
770	869	452	9	1 431	1 728	2 070	WGP3F052077...
852	966	502	10	1 590	1 920	2 300	WGP3F052085...
934	1063	552	11	1 749	2 112	2 530	WGP3F052093...
1016	1159	602	12	1 908	2 304	2 760	WGP3F052101...
1098	1256	653	13	2 067	2 496	2 990	WGP3F052109...
1180	1352	703	14	2 226	2 688	3 220	WGP3F052118...
1262	1449	753	15	2 385	2 880	3 450	WGP3F052126...
1344	1546	803	16	2 544	3 072	3 680	WGP3F052134...
1426	1642	853	17	2 703	3 264	3 910	WGP3F052142...

560 ⇅ [mm] – Verze s nožkami

80	119	63	1	182	207	272	WGP3B056008...
278	357	190	3	546	621	816	WGP3B056027...
360	476	253	4	728	828	1 088	WGP3B056036...
442	595	316	5	910	1 035	1 360	WGP3B056044...
524	714	380	6	1 092	1 242	1 632	WGP3B056052...
606	833	443	7	1 274	1 449	1 904	WGP3B056060...
688	952	506	8	1 456	1 656	2 176	WGP3B056068...
770	1071	569	9	1 638	1 863	2 448	WGP3B056077...
852	1190	633	10	1 820	2 070	2 720	WGP3B056085...
934	1309	696	11	2 002	2 277	2 992	WGP3B056093...
1016	1428	759	12	2 184	2 484	3 264	WGP3B056101...
1098	1547	822	13	2 366	2 691	3 536	WGP3B056109...
1180	1666	886	14	2 548	2 898	3 808	WGP3B056118...
1262	1785	949	15	2 730	3 105	4 080	WGP3B056126...
1344	1904	1012	16	2 912	3 312	4 352	WGP3B056134...
1426	2023	1075	17	3 094	3 519	4 624	WGP3B056142...

↔ [mm]	75/65/20°C [W]	55/45/20°C [W]	Počet článků	Skupina1 Cena bez DPH [EUR]	Skupina2 Cena bez DPH [EUR]	Skupina3 Cena bez DPH [EUR]	Kód produktu ... Kód konfigurace s. 363
620 ⇄ [mm] – Verze s nožkami							
80	119	63	1	182	207	272	WGP3F062008...
278	357	190	3	546	621	816	WGP3F062027...
360	476	253	4	728	828	1 088	WGP3F062036...
442	595	316	5	910	1 035	1 360	WGP3F062044...
524	714	380	6	1 092	1 242	1 632	WGP3F062052...
606	833	443	7	1 274	1 449	1 904	WGP3F062060...
688	952	506	8	1456	1656	2176	WGP3F062068...
770	1071	569	9	1 638	1 863	2 448	WGP3F062077...
852	1190	633	10	1 820	2 070	2 720	WGP3F062085...
934	1309	696	11	2 002	2 277	2 992	WGP3F062093...
1016	1428	759	12	2 184	2 484	3 264	WGP3F062101...
1098	1547	822	13	2 366	2 691	3 536	WGP3F062109...
1180	1666	886	14	2 548	2 898	3 808	WGP3F062118...
1262	1785	949	15	2 730	3 105	4 080	WGP3F062126...
1344	1904	1012	16	2 912	3 312	4 352	WGP3F062134...
1426	2023	1075	17	3 094	3 519	4 624	WGP3F062142...
660 ⇄ [mm] – Verze nástěnná							
80	138	72	1	216	245	324	WGP3B066008...
278	414	217	3	648	735	972	WGP3B066027...
360	552	290	4	864	980	1 296	WGP3B066036...
442	690	362	5	1 080	1 225	1 620	WGP3B066044...
524	828	435	6	1 296	1 470	1 944	WGP3B066052...
606	966	507	7	1 512	1 715	2 268	WGP3B066060...
688	1104	580	8	1728	1960	2592	WGP3B066068...
770	1242	652	9	1 944	2 205	2 916	WGP3B066077...
852	1380	725	10	2 160	2 450	3 240	WGP3B066085...
934	1518	797	11	2 376	2 695	3 564	WGP3B066093...
1016	1656	870	12	2 592	2 940	3 888	WGP3B066101...
1098	1794	942	13	2 808	3 185	4 212	WGP3B066109...
1180	1932	1015	14	3 024	3 430	4 536	WGP3B066118...
1262	2070	1087	15	3 240	3 675	4 860	WGP3B066126...
1344	2208	1160	16	3 456	3 920	5 184	WGP3B066134...
1426	2346	1232	17	3 672	4 165	5 508	WGP3B066142...
720 ⇄ [mm] – Verze s nožkami							
80	138	72	1	216	245	324	WGP3F072008...
278	414	217	3	648	735	972	WGP3F072027...
360	552	290	4	864	980	1 296	WGP3F072036...
442	690	362	5	1 080	1 225	1 620	WGP3F072044...
524	828	435	6	1 296	1 470	1 944	WGP3F072052...
606	966	507	7	1 512	1 715	2 268	WGP3F072060...
688	1104	580	8	1728	1960	2592	WGP3F072068...

↔ [mm]	75/65/20°C [W]	55/45/20°C [W]	Počet článků	Skupina1 Cena bez DPH [EUR]	Skupina2 Cena bez DPH [EUR]	Skupina3 Cena bez DPH [EUR]	Kód produktu ... Kód konfigurace s. 363
770	1242	652	9	1 944	2 205	2 916	WGP3F072077...
852	1380	725	10	2 160	2 450	3 240	WGP3F072085...
934	1518	797	11	2 376	2 695	3 564	WGP3F072093...
1016	1656	870	12	2 592	2 940	3 888	WGP3F072101...
1098	1794	942	13	2 808	3 185	4 212	WGP3F072109...
1180	1932	1015	14	3 024	3 430	4 536	WGP3F072118...
1262	2070	1087	15	3 240	3 675	4 860	WGP3F072126...
1344	2208	1160	16	3 456	3 920	5 184	WGP3F072134...
1426	2346	1232	17	3 672	4 165	5 508	WGP3F072142...

860 ⇅ [mm] – Verze nástěnná

80	176	92	1	262	298	396	WGP3B086008...
278	528	277	3	786	894	1 188	WGP3B086027...
360	704	369	4	1 048	1 192	1 584	WGP3B086036...
442	880	462	5	1 310	1 490	1 980	WGP3B086044...
524	1056	554	6	1 572	1 788	2 376	WGP3B086052...
606	1232	647	7	1 834	2 086	2 772	WGP3B086060...
688	1408	739	8	2096	2384	3168	WGP3B086068...
770	1584	831	9	2 358	2 682	3 564	WGP3B086077...
852	1760	924	10	2 620	2 980	3 960	WGP3B086085...
934	1936	1016	11	2 882	3 278	4 356	WGP3B086093...
1016	2112	1108	12	3 144	3 576	4 752	WGP3B086101...
1098	2288	1201	13	3 406	3 874	5 148	WGP3B086109...
1180	2464	1293	14	3 668	4 172	5 544	WGP3B086118...
1262	2640	1385	15	3 930	4 470	5 940	WGP3B086126...
1344	2816	1478	16	4 192	4 768	6 336	WGP3B086134...
1426	2992	1570	17	4 454	5 066	6 732	WGP3B086142...

920 ⇅ [mm] – Verze s nožkami

80	176	92	1	262	298	396	WGP3F092008...
278	528	277	3	786	894	1 188	WGP3F092027...
360	704	369	4	1 048	1 192	1 584	WGP3F092036...
442	880	462	5	1 310	1 490	1 980	WGP3F092044...
524	1056	554	6	1 572	1 788	2 376	WGP3F092052...
606	1232	647	7	1 834	2 086	2 772	WGP3F092060...
688	1408	739	8	2096	2384	3168	WGP3F092068...
770	1584	831	9	2 358	2 682	3 564	WGP3F092077...
852	1760	924	10	2 620	2 980	3 960	WGP3F092085...
934	1936	1016	11	2 882	3 278	4 356	WGP3F092093...
1016	2112	1108	12	3 144	3 576	4 752	WGP3F092101...
1098	2288	1201	13	3 406	3 874	5 148	WGP3F092109...
1180	2464	1293	14	3 668	4 172	5 544	WGP3F092118...
1262	2640	1385	15	3 930	4 470	5 940	WGP3F092126...
1344	2816	1478	16	4 192	4 768	6 336	WGP3F092134...
1426	2992	1570	17	4 454	5 066	6 732	WGP3F092142...

Plain Towel Rail



DOPORUČUJEME PRO PŘIPOJENÍ AX:



Sada rohová regulační "Mini-malist", Chrom

TGZR017: 228 EUR

Stránka: 308

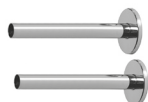

Sada krycí dvojitá, Chrom

TGPCR004: 33 EUR

Stránka: 310



RADIÁTOR VODNÍ:

Připojení:



Rámová konstrukce radiátoru v barvách RAL nebo Chrom.

SKUPINY BAREV A VYKONČENÍ:

Skupina 1 – Raw Metal, Metal Alive, 190 barev RAL, White Soft, Frost, Metallic Brown, Autumn, Evening Garden, Shadow Gold, Graff i Flat Black

Skupina 2 – Full Burnish, Shaded Burnish, Antique Brass, Antique Copper, Bottle Green, Red Wine, Midnight

Skupina 3 – Ornament Gold, Ornament Silver, Ornament Copper, Galvanic Copper, Polished Metal

A ↕ [mm]	B ↔ [mm]	75/65/20°C [W]	55/45/20°C [W]	Skupina 1 Cena bez DPH [EUR]	Skupina 2 Cena bez DPH [EUR]	Skupina 3 Cena bez DPH [EUR]	Kód produktu ... Kód konfigurace s. 363
900	490	357	190	911	984	1 165	WGNT090049...
900	650	595	317	1 155	1 278	1 578	WGNT090065...
900	820	834	445	1 444	1 616	2 036	WGNT090082...
1000	490	416	221	1 012	1 096	1 300	WGNT100049...
1000	650	694	368	1 312	1 452	1 792	WGNT100065...
1200	490	619	324	1 188	1 293	1 523	WGNT120049...
1200	650	1031	539	1 538	1 711	2 096	WGNT120065...

Bergamo



Hliníkový radiátor

DOPORUČUJEME PRO PŘIPOJENÍ LP:



Sada regulační rohová

Chrom

WRZRCK1-CR: 99 EUR

Strona: 282



Sada krycí dvojitá, Chrom

TGPCR001: 27 EUR

Strona: 331



MONTÁŽNÍ SADA:

- Růžice redukční levá 1" x 1/2" — 2 ks
- Růžice redukční pravá 1" x 1/2" — 2 ks
- těsnění — 4 ks
- Zátka — 1 ks
- Odvzdušňovací ventil — 1/2" — 1 ks
- Hmoždinky — 3 ks
- Montážní háky — 3 ks

RADIÁTOR VODNÍ:

Připojení:



K ceně každého radiátoru Bergamo je potřeba dopočítat 14 EUR bez DPH za Montážní sadu v bílé RAL 9016 nebo 16 EUR bez DPH v ostatních Bergamo barvách.

Počet článků	A ↕ [mm]	B ↔ [mm]	75/65/20°C [W]	55/45/20°C [W]	Standardní barvy* Cena bez DPH [EUR]	Barvy pro radiátor Bergamo Cena bez DPH [EUR]	Kód produktu ... Kód konfigurace s. 363
2	590	160	225	116	–	142	WGBER059016...
3	590	240	338	174	–	171	WGBER059024...
4	590	320	450	232	–	199	WGBER059032...
5	590	400	563	290	–	229	WGBER059040...
6	590	480	676	347	–	257	WGBER059048...
7	590	560	788	405	–	286	WGBER059056...
8	590	640	901	463	–	315	WGBER059064...
9	590	720	1013	521	–	347	WGBER059072...
10	590	800	1126	579	283	377	WGBER059080...
11	590	880	1239	637	–	405	WGBER059088...
12	590	960	1351	695	–	432	WGBER059096...
13	590	1040	1464	753	–	460	WGBER059104...
14	590	1120	1576	811	–	488	WGBER059112...
15	590	1200	1689	869	–	516	WGBER059120...
16	590	1280	1802	926	–	544	WGBER059128...
17	590	1360	1914	984	–	572	WGBER059136...
18	590	1440	2027	1042	–	601	WGBER059144...
19	590	1520	2139	1100	–	629	WGBER059152...
20	590	1600	2252	1158	–	657	WGBER059160...

*Standardní barvy: Bílá - RAL 9016 (916)

Bergamo

Hliníkový radiátor

RADIÁTOR ELEKTRICKÝ

Připojení:

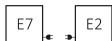

K ceně každého radiátoru Bergamo je potřeba dopočítat 14 EUR bez DPH za Montážní sadu v bílé RAL 9016 nebo 16 EUR bez DPH v ostatních Bergamo barvách.

Počet článků	A ↕ [mm]	B ↔ [mm]	75/65/20°C [W]	55/45/20°C [W]	Standardní barvy* Cena bez DPH [EUR]	Barvy pro radiátor Bergamo Cena bez DPH [EUR]	Kód produktu ... Kód konfigurace s.366
10	590	800			326	420	WLB059080...

*Standardní barvy: Bílá - RAL 9016 (916)

Designové a koupelnové radiátory

Aero V



Barva je zahrnuta v ceně



výběr připojení v ceně

DOPORUČUJEME PRO PŘIPOJENÍ ZX:



Integrovaná sada termostatická, Chrom

WRZT5G1-CR: 145 EUR

WRZT5G2-CR: 145 EUR

Stránka: 296

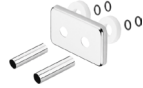

Sada krycí integrovaná, Chrom

TGPCR002: 38 EUR

Stránka: 338



RADIÁTOR VODNÍ

Připojení:



A ⇕ [mm]	B ⇔ [mm]	75/65/20°C [W]	55/45/20°C [W]	Barvy RAL a speciální barvy Cena bez DPH [EUR]	Kód produktu ... Kód konfigurace s. 363
900	325	286	149	579	WGARV090032...
1200	325	366	190	608	WGARV120032...
1200	410	458	237	637	WGARV120041...
1500	325	446	229	637	WGARV150032...
1500	410	558	286	665	WGARV150041...
1800	325	526	268	680	WGARV180032...
1800	410	657	334	723	WGARV180041...

Aero H



Barva je zahrnuta v ceně



výběr připojení v ceně

DOPORUČUJEME PRO PŘIPOJENÍ YL i YP:



Integrovaná sada termostatická, Chrom

WRZT5G1-CR: 145 EUR

WRZT5G2-CR: 145 EUR

Stránka: 296



Háček bodový YO!

WRWYOY001*: 4 EUR

Stránka: 280



Háček bodový HANDY VIP,

Chrom, Sada obsahuje dva háčky

TGWCR005: 23 EUR

Stránka: 278



Sada krycí integrovaná,

Chrom

TGPCR002: 38 EUR

Stránka: 338

RADIÁTOR VODNÍ

Připojení:



A ↕ [mm]	B ↔ [mm]	75/65/20°C [W]	55/45/20°C [W]	Barvy RAL a speciální barvy Cena bez DPH [EUR]	Kód produktu ... Kód konfigurace s.363
325	900	290	160	579	WGARH032090...
325	1200	388	214	608	WGARH032120...
325	1500	485	267	637	WGARH032150...
325	1800	582	320	680	WGARH032180...
410	1200	480	265	637	WGARH041120...
410	1500	600	330	665	WGARH041150...
410	1800	720	396	723	WGARH041180...

Aero HG



Barva je zahrnuta v ceně



výběr připojení v ceně

DOPORUČUJEME PRO PŘIPOJENÍ YL i YP:



Integrovaná sada termostatická, Chrom

WRZT5G1-CR: 145 EUR

WRZT5G2-CR: 145 EUR

Stránka: 296



Háček bodový YO!

WRWYOY001*: 4 EUR

Stránka: 280



Háček bodový HANDY VIP,

Chrom, Sada obsahuje dva

háčky

TGWCR005: 23 EUR

Stránka: 278



Sada krycí integrovaná,

Chrom

TGPCR002: 38 EUR

Stránka: 338

RADIÁTOR VODNÍ

Připojení:



A \updownarrow [mm]	B \leftrightarrow [mm]	75/65/20°C [W]	55/45/20°C [W]	Barvy RAL a speciální barvy Cena bez DPH [EUR]	Kód produktu ... Kód konfigurace s.363
370	900	290	160	579	WGARG037090...
370	1200	388	214	608	WGARG037120...
370	1500	485	267	637	WGARG037150...
370	1800	582	320	680	WGARG037180...
455	1200	480	265	637	WGARG045120...
455	1500	600	330	665	WGARG045150...
455	1800	720	396	723	WGARG045180...

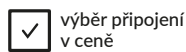

výběr přípojení
v ceně

DOPORUČUJEME PRO PŘIPOJENÍ Z1 i Z8:



Integrovaná sada termostatická, Chrom

WRZT5G1-CR: 145 EUR
WRZT5G2-CR: 145 EUR

Stránka: 296



Sada krycí integrovaná, Chrom

TGPCR002: 38 EUR

Stránka: 338



Topná tyč MOA, Chrom

WEMOA*: 105 EUR

Stránka: 259



Háček bodový YO!

WRWYOY001*: 4 EUR

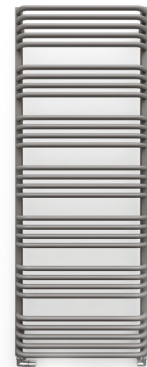

Stránka: 280

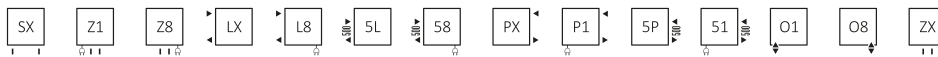

RADIÁTOR VODNÍ / VODNĚ-ELEKTRICKÝ (DOKOUPIT TOPNOU TYČ)

Připojení:



A ↕ [mm]	B ↔ [mm]	Barva ze vzorníku RAL a speciálních barev			Galvanický povrch Chrom			Barvy RAL a speciální barvy Cena bez DPH [EUR]	Chrom Cena bez DPH [EUR]	Kód produktu ... Kód konfigurace s. 363
		75/65/20°C [W]	55/45/20°C [W]	 [W]	75/65/20°C [W]	55/45/20°C [W]	 [W]			
540	300	180	99	200	126	64	120	178	266	WGALE054030...
540	400	238	129	200	167	85	200	183	287	WGALE054040...
540	500	299	161	300	209	107	200	188	307	WGALE054050...
540	600	355	190	400	249	127	300	194	325	WGALE054060...
760	300	257	137	300	180	92	200	194	324	WGALE076030...
760	400	330	177	300	231	118	200	201	351	WGALE076040...
760	500	412	220	400	288	147	300	211	378	WGALE076050...
760	600	481	257	600	337	172	400	225	408	WGALE076060...
1140	300	362	194	400	253	129	300	228	432	WGALE114030...
1140	400	479	194	400	335	171	400	244	479	WGALE114040...
1140	500	591	313	600	414	211	400	260	523	WGALE114050...
1140	600	711	380	800	498	254	600	279	566	WGALE114060...
1580	500	793	425	800	555	283	600	307	668	WGALE158050...
1580	600	949	508	1000	664	339	600	328	726	WGALE158060...
1580	700	1104	591	1000	773	394	800	350	788	WGALE158070...
1580	800	1253	670	1200	–	–	–	373	–	WGALE158080...

RADIÁTOR ELEKTRICKÝ (CENA VČETNĚ NÁPLNĚ A ZVOLENÉ TOPNÉ TYČE)

Připojení:



A ↕ [mm]	B ↔ [mm]	Výkon [W]		MEG Cena bez DPH [EUR]		MOA/DRY/TDY Cena bez DPH [EUR] (MOA IR: +12 EUR) (MOA BLUE: +38 EUR)		ONE Cena bez DPH [EUR] (Nezabudovaná, v 8cm profilu v barvě radiátoru)		REG 2 Cena bez DPH [EUR]		REG 3 Cena bez DPH [EUR]		SIM Cena bez DPH [EUR]		Terma Split třída I Cena bez DPH [EUR] (nezapomeňte si koupit regulátor KTX)		Smart Split třída I Cena bez DPH [EUR] (nezapomeňte si koupit SMART Wi-Fi regulátor VEO)		Kód produktu ... Kód konfigurace s.366
		Barva	Chrom	Barvy RAL a speciální barvy	Chrom	Barvy RAL a speciální barvy	Chrom	Barvy RAL a speciální barvy	Chrom	Barvy RAL a speciální barvy	Chrom	Barvy RAL a speciální barvy	Chrom	Barvy RAL a speciální barvy	Chrom	Barvy RAL a speciální barvy	Chrom	Barvy RAL a speciální barvy	Chrom	
540	300	200	120	273	361	280	368	300	388	250	339	260	349	241	329	226	314	226	314	WLALE054030...
540	400	200	200	277	381	285	388	305	408	255	359	265	368	246	349	231	334	231	334	WLALE054040...
540	500	300	200	282	402	290	409	309	429	260	380	270	389	250	370	236	355	236	355	WLALE054050...
540	600	400	300	289	420	296	427	316	447	266	398	276	408	257	388	242	373	242	373	WLALE054060...
760	300	300	200	289	419	296	426	316	446	266	397	276	407	257	387	242	372	242	372	WLALE076030...
760	400	300	200	296	446	303	453	323	473	274	424	284	434	264	414	249	399	249	399	WLALE076040...
760	500	400	300	306	473	313	480	333	500	284	451	293	461	274	441	259	426	259	426	WLALE076050...
760	600	600	400	319	502	327	510	346	530	297	480	307	490	287	471	273	456	273	456	WLALE076060...
1140	300	400	300	323	527	330	534	350	554	301	505	311	515	291	495	276	480	276	480	WLALE114030...
1140	400	400	400	339	574	346	581	366	601	317	552	327	562	307	542	292	527	292	527	WLALE114040...
1140	500	600	400	355	618	362	625	382	645	333	596	343	606	323	586	308	571	308	571	WLALE114050...
1140	600	800	600	373	661	381	668	400	688	351	639	361	649	341	629	327	614	327	614	WLALE114060...
1580	500	800	600	402	763	409	771	429	790	380	741	389	751	370	731	355	716	355	716	WLALE158050...
1580	600	1000	600	423	821	430	828	450	848	400	799	410	809	391	789	376	774	376	774	WLALE158060...
1580	700	1000	800	445	882	452	890	472	909	423	860	432	870	413	850	398	836	398	836	WLALE158070...
1580	800	1200	-	468	-	475	-	495	-	446	-	456	-	436	-	421	-	421	-	WLALE158080...

Alex One



výběr připojení
v ceně

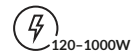

Radiátor se zabudovanou topnou tyčí One. Funkce topné tyče ONE: Stránka 209.

DOPORUČUJEME PRO PŘIPOJENÍ S1 i S8:



Integrovaná sada termos-
tatická s ponornou trubicí,
Chrom



WRZT5G5-CR: 151 EUR



WRZT5G6-CR: 151 EUR

Stránka: 298



Sada krycí integrovaná,
Chrom

TGPCR002: 38 EUR

Stránka: 338



Regulátor TTIR1

TGRTBI001: 104 EUR

Stránka: 268



Háček bodový YO!

WRWYOY001*: 4 EUR

Stránka: 280

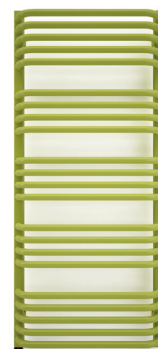



RADIÁTOR VODNĚ-ELEKTRICKÝ (CENA VČETNĚ ZABUDOVANÉ TOPNÉ TYČE ONE)

Připojení:



Vyber druh kabelu:



A ↕ [mm]	B ↔ [mm]	Barva ze vzorníku RAL a speciálních barev			Galvanický povrch Chrom			Barvy RAL a speciální barvy Cena bez DPH [EUR]	Chrom Cena bez DPH [EUR]	Kód produktu ... Kód konfigurace s. 364
		75/65/20°C [W]	55/45/20°C [W]	 [W]	75/65/20°C [W]	55/45/20°C [W]	 [W]			
760	300	257	137	300	180	92	200	291	421	WZALN076030...
760	400	330	177	300	231	118	200	298	448	WZALN076040...
760	500	412	220	400	288	147	300	308	475	WZALN076050...
760	600	481	257	600	337	172	400	322	505	WZALN076060...
1140	300	362	194	400	253	129	300	325	530	WZALN114030...
1140	400	479	257	400	335	171	400	341	576	WZALN114040...
1140	500	591	313	600	414	211	400	357	621	WZALN114050...
1140	600	711	380	800	498	254	600	376	664	WZALN114060...
1580	500	793	425	800	555	283	600	404	766	WZALN158050...
1580	600	949	508	1000	664	339	600	425	823	WZALN158060...
1580	700	1104	591	1000	773	394	800	-	-	WZALN158070...

Alex One

RADIÁTOR ELEKTRICKÝ (CENA VČETNĚ NÁPLNĚ A ZABUDOVANÉ TOPNÉ TYČE ONE)

Připojení:



A ⇕ [mm]	B ↔ [mm]	Výkon [W]		Barvy RAL a speciální barvy Cena bez DPH [EUR]	Chrom Cena bez DPH [EUR]	Kód produktu ... Kód konfigurace s. 365
		Barva	Chrom			
760	300	300	200	309	440	WWALN076030...
760	400	300	200	317	467	WWALN076040...
760	500	400	300	327	494	WWALN076050...
760	600	600	400	340	523	WWALN076060...
1140	300	400	300	344	548	WWALN114030...
1140	400	400	400	360	595	WWALN114040...
1140	500	600	400	376	639	WWALN114050...
1140	600	800	600	394	682	WWALN114060...
1580	500	800	600	423	784	WWALN158050...
1580	600	1000	600	443	842	WWALN158060...
1580	700	1000	800	-	-	WWALN158070...

Angus V



Barva je zahrnuta v ceně

výběr připojení v ceně

DOPORUČUJEME PRO PŘIPOJENÍ ZX, Y1, Y8, YL i YP:



Integrovaná sada termostatická,
Chrom

WRZT5G1-CR: 145 EUR

WRZT5G2-CR: 145 EUR

Stránka: 296



Sada krycí integrovaná, Chrom

TGPCR002: 38 EUR

Stránka: 338



Háček bodový ZIP V 30, Chrom

WRWZIP012 KCRO 44 EUR

Stránka: 281



RADIÁTOR VODNÍ / VODNĚ-ELEKTRICKÝ (DOKOUPIT TOPNOU TYČ)

Připojení:

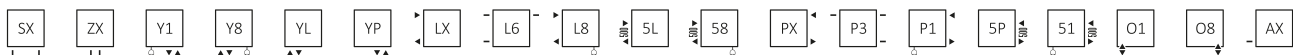

A ↕ [mm]	B ↔ [mm]	75/65/20°C [W]	55/45/20°C [W]	 [W]	Barvy RAL a speciální barvy Cena bez DPH [EUR]	Kód produktu ... Kód konfigurace s. 363
1140	360	421	224	400	405	WGANG114036...
1300	440	557	293	600	462	WGANG130044...
1460	520	711	372	800	548	WGANG146052...
1620	600	905	472	1000	606	WGANG162060...
1780	680	1116	580	1200	692	WGANG178068...

Angus V E



Barva je zahrnuta v ceně



výběr připojení v ceně

DOPORUČUJEME:



Háček bodový ZIP V 30,

Chrom

WRWZIP012 KCRO 44 EUR

Stránka: 281



RADIÁTOR ELEKTRICKÝ (CENA VČETNĚ NÁPLNĚ A ZVOLENÉ TOPNÉ TYČE)

Připojení:



A ↕ [mm]	B ↔ [mm]	Výkon [W]	MEG Cena bez DPH [EUR]	MOA/DRY/ TDY Cena bez DPH [EUR] (MOA IR: +12 EUR) (MOA BLUE: +38 EUR)	ONE Cena bez DPH [EUR] (Nezabudovaná, v 8cm profilu v barvě radiátoru)	REG 2 Cena bez DPH [EUR]	REG 3 Cena bez DPH [EUR]	SIM Cena bez DPH [EUR]	Terma Split třída I Cena bez DPH [EUR] (nezapomeňte si koupit regulátor KTX)	Smart Split třída I Cena bez DPH [EUR] (nezapomeňte si koupit SMART WI-FI regulátor VEO)	Kód produktu ... Kód konfigurace s.366
1140	360	400	500	507	527	478	488	468	453	453	WLANG114036...
1300	440	600	557	564	584	534	544	525	510	510	WLANG130044...
1460	520	800	643	650	670	621	630	611	596	596	WLANG146052...
1620	600	1000	700	708	728	678	688	668	654	654	WLANG162060...
1780	680	1200	787	794	-	764	774	755	-	740	WLANG178068...

Angus DW (dělicí stěna kolmá)



Barva je zahrnuta v ceně

výběr připojení v ceně

DOPORUČUJEME PRO PŘIPOJENÍ ZX, Y1, Y8, YL i YP:



Integrovaná sada termostatická,
Chrom

WRZT5G3-CR: 146 EUR

WRZT5G4-CR: 146 EUR

Stránka: 296



Sada krycí integrovaná, Chrom

TGPCR002: 38 EUR

Stránka: 338



Háček bodový ZIP V 30, Chrom

WRWZIP012 KCRO: 44 EUR

Stránka: 281



RADIÁTOR VODNÍ / VODNĚ-ELEKTRICKÝ (DOKOUPIT TOPNOU TYČ)

Připojení:

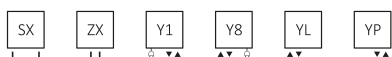

A ↕ [mm]	B ↔ [mm]	75/65/20°C [W]	55/45/20°C [W]	 [W]	Barvy RAL a speciální barvy Cena bez DPH [EUR]	Kód produktu ... Kód konfigurace s. 363
1140	360	421	224	400	511	WGANS114036...
1300	440	557	293	600	553	WGANS130044...
1460	520	711	372	800	623	WGANS146052...
1620	600	905	472	1000	680	WGANS162060...
1780	680	1116	580	1200	764	WGANS178068...

Angus DW E (dělicí stěna kolmá)



Barva je zahrnuta v ceně



výběr připojení v ceně

DOPORUČUJEME:



Háček bodový ZIP V 30,

Chrom

WRWZIP012 KCRO: 44 EUR

Stránka: 281



RADIÁTOR ELEKTRICKÝ (CENA VČETNĚ NÁPLNĚ A ZVOLENÉ TOPNÉ TYČE)

Připojení:



A ↕ [mm]	B ↔ [mm]	Výkon [W]	MEG Cena bez DPH [EUR]	MOA/DRY/ TDY Cena bez DPH [EUR] (MOA IR: +12 EUR) (MOA BLUE: +38 EUR)	ONE Cena bez DPH [EUR] (Nezabudovaná, v 8cm profilu v barvě radiátoru)	REG 2 Cena bez DPH [EUR]	REG 3 Cena bez DPH [EUR]	SIM Cena bez DPH [EUR]	Terma Split třída I Cena bez DPH [EUR] (nezapomeňte si koupit regulátor KTX)	Smart Split třída I Cena bez DPH [EUR] (nezapomeňte si koupit SMART Wi-Fi regulátor VEO)	Kód produktu ... Kód konfigurace s. 366
1140	360	400	606	613	633	584	593	574	559	559	WLANS114036...
1300	440	600	648	655	675	625	635	616	601	601	WLANS130044...
1460	520	800	718	725	745	696	705	686	671	671	WLANS146052...
1620	600	1000	774	782	801	752	762	742	728	728	WLANS162060...
1780	680	1200	858	865	885	836	846	826	811	811	WLANS178068...

Angus H



Barva je zahrnuta v ceně

výběr připojení v ceně

DOPORUČUJEME PRO PŘIPOJENÍ YL, YP, Y7 i Y2:



Integrovaná sada termostatická, Chrom

WRZT5G1-CR: 145 EUR

WRZT5G2-CR: 145 EUR

Stránka: 296



Sada krycí integrovaná, Chrom

TGPCR002: 38 EUR

Stránka: 338



Topná tyč KTX3, Chrom

WEKT3*: 102 EUR

Stránka: 254

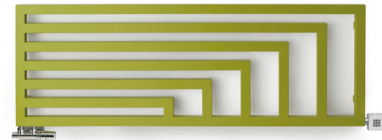

RADIÁTOR VODNÍ / VODNĚ-ELEKTRICKÝ (DOKOUPIT TOPNOU TYČ)

Připojení:

Výška [mm] 360÷680:

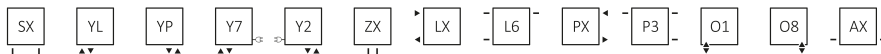

Výška [mm] 600÷680:



A ↑ [mm]	B ↔ [mm]	75/65/20°C [W]	55/45/20°C [W]	[W]	Barvy RAL a speciální barvy Cena bez DPH [EUR]	Kód produktu ... Kód konfigurace s.363
360	1140	416	227	400	405	WGANH036114...
440	1300	538	292	600	462	WGANH044130...
520	1460	680	366	800	548	WGANH052146...
600	1620	841	449	800	606	WGANH060162...
680	1780	1022	540	1000	692	WGANH068178...

Angus H

RADIÁTOR ELEKTRICKÝ (CENA VČETNĚ NÁPLNĚ A ZVOLENÉ TOPNÉ TYČE)

Připojení:



A ↕ [mm]	B ↔ [mm]	Výkon [W]	MEG Cena bez DPH [EUR]	MOA/DRY/ TDY Cena bez DPH [EUR] (MOAIR: +12 EUR) (MOABLUE: +38 EUR)	ONE Cena bez DPH [EUR] (Nezabudovaná, v 8cm profilu v barvě radiátoru)	REG 2 Cena bez DPH [EUR]	REG 3 Cena bez DPH [EUR]	SIM Cena bez DPH [EUR]	Terma Split třída I Cena bez DPH [EUR] (nezapomeňte si koupit regulátor KTX)	Smart Split třída I Cena bez DPH [EUR] (nezapomeňte si koupit SMART Wi-Fi regulátor VEO)	Kód produktu ... Kód konfigurace s. 366
360	1140	400	500	507	527	478	488	468	453	453	WLANH044100...
440	1300	600	557	564	584	534	544	525	510	510	WLANH044130...
520	1460	800	643	650	670	621	630	611	596	596	WLANH052146...
600	1620	800	700	708	728	678	688	668	654	654	WLANH060162...
680	1780	1000	787	794	814	764	774	755	740	740	WLANH068178...

Bookie



Barva je zahrnuta v ceně



výběr připojení v ceně

DOPORUČUJEME PRO PŘIPOJENÍ ZX:



Integrovaná sada termostatická, Chrom

WRZT5G1-CR: 145 EUR

WRZT5G2-CR: 145 EUR

Stránka: 296



Sada krycí integrovaná, Chrom

TGPCR002: 38 EUR

Stránka: 338



RADIÁTOR VODNÍ

Připojení:



A ↕ [mm]	B ↔ [mm]	75/65/20°C [W]	55/45/20°C [W]	Barvy RAL a speciální barvy Cena bez DPH [EUR]	Kod produktu ... Kod konfiguraci s. 358
655	300	246	133	429	WGBUK065030
655	400	308	166	438	WGBUK065040
655	500	370	199	447	WGBUK065050
1155	300	420	226	594	WGBUK115030
1155	400	515	278	617	WGBUK115040
1155	500	616	332	640	WGBUK115050
1655	300	582	314	730	WGBUK165030
1655	400	722	389	763	WGBUK165040
1655	500	862	465	795	WGBUK165050

Bone



výběr připojení v ceně

DOPORUČUJEME PRO PŘIPOJENÍ ZX, Z1 i Z8:



Integrovaná sada termostatická, Chrom

WRZT5G1-CR: 145 EUR
WRZT5G2-CR: 145 EUR

Stránka: 296



Sada krycí integrovaná, Chrom

TGPCR002: 38 EUR

Stránka: 338



Háček bodový ZIP H 20, Chrom

WRWZIP010 KCRO: 42 EUR

Stránka: 280



Topná tyč ONE, Chrom

WEOPX*: 127 EUR

Stránka: 250



RADIÁTOR VODNÍ / VODNĚ-ELEKTRICKÝ (DOKOUPIT TOPNOU TYČ)

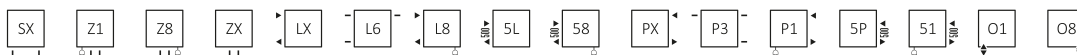

A ↓ [mm]	B ↔ [mm]	Barva ze vzorníku RAL a speciálních barev			Galvanický povrch Chrom			Barvy RAL a speciální barvy Cena bez DPH [EUR]	Chrom Cena bez DPH [EUR]	Kód produktu ... Kód konfigurace s. 363
		75/65/20°C [W]	55/45/20°C [W]		75/65/20°C [W]	55/45/20°C [W]				
760	500	320	173	300	224	121	200	248	397	WGBON076050...
760	600	384	208	400	269	145	300	255	427	WGBON076060...
1260	500	503	271	600	352	190	400	285	489	WGBON126050...
1260	600	603	325	600	422	227	400	297	549	WGBON126060...
1510	500	607	323	600	425	226	400	325	656	WGBON151050...
1510	600	728	387	800	510	271	600	339	734	WGBON151060...

RADIÁTOR ELEKTRICKÝ (CENA VČETNĚ NÁPLNĚ A ZVOLENÉ TOPNÉ TYČE)

Připojení:

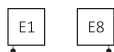

A ↓ [mm]	B ↔ [mm]	Výkon [W]	MEG		MOA/DRY/TDY		ONE		REG 2		REG 3		SIM		Terma Split třída I		Smart Split třída I		Kód produktu ... Kód konfigurace s. 366	
			Cena bez DPH [EUR]	Chrom	Cena bez DPH [EUR]	Chrom	Cena bez DPH [EUR]	Chrom	Cena bez DPH [EUR]	Chrom	Cena bez DPH [EUR]	Chrom	Cena bez DPH [EUR]	Chrom	Cena bez DPH [EUR]	Chrom	Cena bez DPH [EUR]	Chrom		
760	500	300	200	343	491	350	499	370	518	321	469	330	479	311	459	296	445	296	445	WLBON076050...
760	600	400	300	350	522	357	530	377	549	328	500	338	510	318	490	303	475	303	475	WLBON076060...
1260	500	600	400	380	584	387	591	407	611	357	562	367	571	348	552	333	537	333	537	WLBON126050...
1260	600	600	400	392	644	399	651	419	671	370	622	380	632	360	612	345	597	345	597	WLBON126060...
1510	500	600	400	420	751	427	758	447	778	398	729	408	739	388	719	373	704	373	704	WLBON151050...
1510	600	800	600	434	828	441	836	461	855	412	806	421	816	402	796	387	782	387	782	WLBON151060...

Bone DW (dřilící stěna kolmá)



DOPORUČUJEME PRO PŘIHOJENÍ ZX i Z1:



Integrovaná sada termostatická,

Chrom

WRZT5G3-CR: 146 EUR

WRZT5G4-CR: 146 EUR

Stránka: 296



Sada krycí integrovaná, Chrom

TGPCR002: 38 EUR

Stránka: 338



Háček bodový ZIP H 20, Chrom

WRWZIP010 KCRO: 42 EUR

Stránka: 280



RADIÁTOR VODNÍ / VODNĚ-ELEKTRICKÝ (DOKOUPIT TOPNOU TYČ)

Připojení:



A ↕ [mm]	B ↔ [mm]	75/65/20°C [W]	55/45/20°C [W]	 [W]	Barvy RAL a speciální barvy Cena bez DPH [EUR]	Kód produktu ... Kód konfigurace: 363
1610	500	607	323	600	447	WGBSD161050...
1910	500	764	404	800	485	WGBSD191050...

RADIÁTOR ELEKTRICKÝ (CENA VČETNĚ NÁPLNĚ A ZVOLENÉ TOPNÉ TYČE)

Připojení:



A ↕ [mm]	B ↕ [mm]	Výkon [W]	MEG Cena bez DPH [EUR]	MOA/DRY/TDY Cena bez DPH [EUR] (MOAIR: +12 EUR) (MOABLUJE: +38 EUR)	ONE Cena bez DPH [EUR] (Nezabudovaná, v 8cm profilu v barvě radiátoru)	REG 2 Cena bez DPH [EUR]	REG 3 Cena bez DPH [EUR]	SIM Cena bez DPH [EUR]	Terma Split třída I Cena bez DPH [EUR] (nezapomeňte si koupit regulátor KTX)	Smart Split třída I Cena bez DPH [EUR] (nezapomeňte si koupit SMART Wi-Fi regulátor VEO)	Kód produktu ... Kód konfigurace s. 366
1610	500	600	542	549	569	520	530	510	495	495	WLBSD161050...
1910	500	800	580	587	607	558	568	548	533	533	WLBSD191050...

Bone One

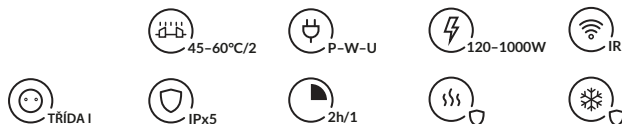

Radiátor se zabudovanou topnou tyčí One. Funkce topné tyče ONE: Stránka 209.

DOPORUČUJEME PRO PŘIPOJENÍ S1 i S8:



Integrovaná sada termos-tatická s ponornou trubici,
Chrom



WRZT5G5-CR: 151EUR



WRZT5G6-CR: 151EUR

Stránka: 298



Sada krycí integrovaná,
Chrom

TGPCR002: 38EUR

Stránka: 338



Regulátor TTIR1

TGRTBI001: 104EUR

Stránka: 268



Háček bodový ZIP H 20,

Chrom

WRWZIP010 KCRO: 42EUR

Stránka: 280

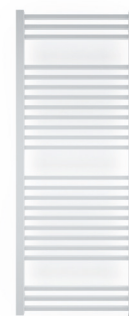

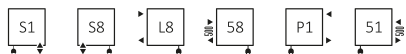

RADIÁTOR VODNĚ-ELEKTRICKÝ (CENA VČETNĚ ZABUDOVANÉ TOPNÉ TYČE ONE)

Připojení:

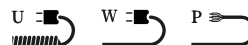

Vyber druh kabelu:



A ↑ [mm]	B ↔ [mm]	Barva ze vzorníku RAL a speciálních barev			Galvanický povrch Chrom			Barvy RAL a speciální barvy Cena bez DPH [EUR]	Chrom Cena bez DPH [EUR]	Kód produktu ... Kód konfigurace s. 364
		75/65/20°C [W]	55/45/20°C [W]	 [W]	75/65/20°C [W]	55/45/20°C [W]	 [W]			
760	500	320	173	300	224	121	200	345	494	WZBNN076050...
760	600	384	208	400	269	145	300	352	525	WZBNN076060...
1260	500	503	271	600	352	190	400	382	586	WZBNN126050...
1260	600	603	325	600	422	227	400	394	646	WZBNN126060...
1510	500	607	323	600	425	226	400	423	753	WZBNN151050...
1510	600	728	387	800	510	271	600	436	831	WZBNN151060...

Bone One

RADIÁTOR ELEKTRICKÝ (CENA VČETNĚ NÁPLNĚ A ZABUDOVANÉ TOPNÉ TYČE ONE)

Připojení:

E1

E8

A ↕ [mm]	B ↔ [mm]	Výkon [W]		Barvy RAL a speciální barvy Cena bez DPH [EUR]	Chrom Cena bez DPH [EUR]	Kód produktu ... Kód konfigurace s. 365
		Barva	Chrom			
760	500	300	200	364	512	WWBNN076050...
760	600	400	300	371	543	WWBNN076060...
1260	500	600	400	400	605	WWBNN126050...
1260	600	600	400	413	665	WWBNN126060...
1510	500	600	400	441	772	WWBNN151050...
1510	600	800	600	455	849	WWBNN151060...

Cane



Barva je zahrnuta v ceně

výběr připojení v ceně

DOPORUČUJEME PRO PŘIPOJENÍ Z1, Z8, Y1, Y8 i ZX:



Integrovaná sada termostatická, Chrom

WRZT5G1-CR: 145 EUR

WRZT5G2-CR: 145 EUR

Stránka: 296



Sada krycí integrovaná, Chrom

TGPCR002: 38 EUR

Stránka: 338



Regulátor TTIR1

TGRTBI001: 104 EUR

Stránka: 268



Topná tyč MOA IR, Chrom

WEMOR*: 117 EUR

Stránka: 258



RADIÁTOR VODNÍ / VODNĚ-ELEKTRICKÝ (DOKOUPIT TOPNOU TYČ)

Připojení:

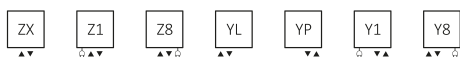

A ↕ [mm]	B ↔ [mm]	75/65/20°C [W]	55/45/20°C [W]	☺ [W]	Barvy RAL a speciální barvy Cena bez DPH [EUR]	Kód produktu ... Kód konfigurace s. 363
1300	390	569	300	600	734	WGCAN130039...
1600	390	670	354	800	843	WGCAN160039...
1900	390	768	405	800	952	WGCAN190039...



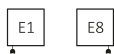

RADIÁTOR ELEKTRICKÝ (CENA VČETNĚ NÁPLNĚ A ZVOLENÉ TOPNÉ TYČE)

Připojení:



A ↕ [mm]	B ↔ [mm]	Výkon [W]	MEG Cena bez DPH [EUR]	MOA/DRY/ TDY Cena bez DPH [EUR] (MOA IR: +12 EUR) (MOA BLUE: +38 EUR)	ONE Cena bez DPH [EUR] (Nezabudovaná, v 8cm profilu v barvě radiátoru)	REG 2 Cena bez DPH [EUR]	REG 3 Cena bez DPH [EUR]	SIM Cena bez DPH [EUR]	Terma Split třída I Cena bez DPH [EUR] (nezapomeňte si koupit regulátor KTX)	Smart Split třída I Cena bez DPH [EUR] (nezapomeňte si koupit SMARTWi-Fi regulátor VEO)	Kód produktu ... Kód konfigurace s. 366
1300	390	600	843	850	870	820	830	811	796	796	WLCAN130039...
1600	390	800	953	961	980	931	941	921	906	906	WLCAN160039...
1900	390	800	1064	1072	1091	1042	1052	1032	1017	1017	WLCAN190039...

Case Slim





 Barva je zahrnuta v ceně

 výběr připojení v ceně

DOPORUČUJEME PRO PŘIPOJENÍ Z1, Z8 i ZX:



Sada krycí integrovaná, Chrom

TGPCR002: 38 EUR

Stránka: 338



Držák CASE Slim

cena 1 Euro - při objednání spolu s radiátorem.

Každý další držák navíc za standardní cenu.

Stránka: 284



Integrovaná sada termostatická, Chrom

WRZT5G1-CR: 145 EUR

WRZT5G2-CR: 145 EUR

Stránka: 296



RADIÁTOR VODNÍ / VODNĚ-ELEKTRICKÝ (DOKOUPIT TOPNOU TYČ)

Připojení:

Výška [mm] 585÷1810:



Výška [mm] 585:



Výška [mm]

1360÷1810:

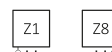

RADIÁTOR SE SKLÁDÁ ZE 2 ČÁSTÍ

1. ČÁST - VÝMĚNÍK RADIÁTORU

A ↓ [mm]	B ↔ [mm]	75/65/20°C [W]	55/45/20°C [W]	 [W]	Barvy RAL a speciální barvy Cena bez DPH [EUR]	Kód produktu ... Kód konfigurace s. 363 výměník skladem vždy RAL 9016, volíte si barvu montážních úchytů, RAL 9016 skladem
585	900	438	229	–	374	WGCSX058090 K...
585	1100	536	281	–	389	WGCSX058110 K...
585	1300	634	332	–	449	WGCSX058130 K...
1360	420	422	219	400	315	WGCSX136042 K...
1360	520	523	271	600	342	WGCSX136052 K...
1360	620	624	324	600	372	WGCSX136062 K...
1585	420	470	243	400	344	WGCSX158042 K...
1585	520	580	300	600	380	WGCSX158052 K...
1585	620	693	358	800	409	WGCSX158062 K...
1810	420	516	266	600	374	WGCSX181042 K...
1810	520	639	330	600	408	WGCSX181052 K...
1810	620	762	393	800	448	WGCSX181062 K...

2. ČÁST – OPLÁŠTĚNÍ VÝMĚNÍKU

A ⇕ (mm)	B ↔ (mm)	KOV		SKLO v barvách RAL		ZRCADLO		POTISK SKLA dle přání	
		Barvy RAL a speciální barvy Cena bez DPH [EUR]	Kód produktu ... Kód konfigurace s. 369	Barvy RAL Cena bez DPH [EUR]	Kód produktu ... Kód konfigurace s. 369	Barvy RAL a speciální barvy Cena bez DPH [EUR]	Kód produktu ... Kód konfigurace s. 369	Barvy RAL a speciální barvy Cena bez DPH [EUR]	Kód produktu ... Kód konfigurace s. 369
585	900	304	WRBCSS058090	466	WRBCSG058090	375	WRBCSM058090	469	WRBCSP058090
585	1100	369	WRBCSS058110	563	WRBCSG058110	451	WRBCSM058110	567	WRBCSP058110
585	1300	394	WRBCSS058130	621	WRBCSG058130	489	WRBCSM058130	625	WRBCSP058130
1360	420	298	WRBCSS136042	472	WRBCSG136042	373	WRBCSM136042	475	WRBCSP136042
1360	520	324	WRBCSS136052	537	WRBCSG136052	414	WRBCSM136052	540	WRBCSP136052
1360	620	353	WRBCSS136062	604	WRBCSG136062	457	WRBCSM136062	608	WRBCSP136062
1585	420	316	WRBCSS158042	517	WRBCSG158042	401	WRBCSM158042	520	WRBCSP158042
1585	520	348	WRBCSS158052	593	WRBCSG158052	450	WRBCSM158052	597	WRBCSP158052
1585	620	375	WRBCSS158062	664	WRBCSG158062	493	WRBCSM158062	670	WRBCSP158062
1810	420	336	WRBCSS181042	563	WRBCSG181042	431	WRBCSM181042	567	WRBCSP181042
1810	520	365	WRBCSS181052	643	WRBCSG181052	480	WRBCSM181052	648	WRBCSP181052
1810	620	400	WRBCSS181062	728	WRBCSG181062	533	WRBCSM181062	734	WRBCSP181062

Cena se počítá jako pro Ventily a příslušenství

RADIÁTOR ELEKTRICKÝ (CENA VČETNĚ NÁPLNĚ A ZVOLENÉ TOPNÉ TYČE)

Připojení:

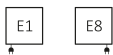

RADIÁTOR SE SKLÁDÁ ZE 2 ČÁSTÍ

1. ČÁST – VÝMĚNÍK RADIÁTORU

A ⇕ (mm)	B ↔ (mm)	Výkon [W]	MEG Cena bez DPH [EUR]	MOA/DRY/ TDY Cena bez DPH [EUR] (MOAIR: +12 EUR) (MOABLUE: +38 EUR)	ONE Cena bez DPH [EUR] (Nezabudovaná, v 8cm profilu v barvě radiátoru)	REG 2 Cena bez DPH [EUR]	REG 3 Cena bez DPH [EUR]	SIM Cena bez DPH [EUR]	Terma Split třída I Cena bez DPH [EUR] (nezapomeňte si koupit regulátor KTX)	Smart Split třída I Cena bez DPH [EUR] (nezapomeňte si koupit SMART Wi-Fi regulátor VEO)	Kód produktu ... Kód konfigurace s. 366 výměník skladem vždy RAL 9016, volte si barvu montážních úchytů, RAL 9016 skladem
585	900	–	–	–	–	–	–	–	–	–	WLCSX058090 K...
585	1100	–	–	–	–	–	–	–	–	–	WLCSX058110 K...
585	1300	–	–	–	–	–	–	–	–	–	WLCSX058130 K...
1360	420	400	456	463	483	434	444	424	409	409	WLCSX136042 K...
1360	520	600	487	494	514	465	475	455	440	440	WLCSX136052 K...
1360	620	600	522	529	549	500	510	490	475	475	WLCSX136062 K...
1585	420	400	489	497	516	467	477	457	443	443	WLCSX158042 K...
1585	520	600	531	538	558	509	519	499	484	484	WLCSX158052 K...
1585	620	800	565	573	592	543	553	533	519	519	WLCSX158062 K...
1810	420	600	524	532	551	502	512	492	478	478	WLCSX181042 K...
1810	520	600	565	572	592	542	552	533	518	518	WLCSX181052 K...
1810	620	800	611	618	638	589	598	579	564	564	WLCSX181062 K...

Case Slim

2. ČÁST - OPLÁŠTĚNÍ VÝMĚNÍKU

A ↕ [mm]	B ↔ [mm]	KOV		SKLO v barvách RAL		ZRCADLO		POTISK SKLA dle přání	
		Barvy RAL a speciální barvy Cena bez DPH [EUR]	Kód produktu ... Kód konfigurace s. 369	Barvy RAL Cena bez DPH [EUR]	Kód produktu ... Kód konfigurace s. 369	Barvy RAL a speciální barvy Cena bez DPH [EUR]	Kód produktu ... Kód konfigurace s. 369	Barvy RAL a speciální barvy Cena bez DPH [EUR]	Kód produktu ... Kód konfigurace s. 369
585	900	304	WRBCSS058090	466	WRBCSG058090	375	WRBCSM058090	469	WRBCSP058090
585	1100	369	WRBCSS058110	563	WRBCSG058110	451	WRBCSM058110	567	WRBCSP058110
585	1300	394	WRBCSS058130	621	WRBCSG058130	489	WRBCSM058130	625	WRBCSP058130
1360	420	298	WRBCSS136042	472	WRBCSG136042	373	WRBCSM136042	475	WRBCSP136042
1360	520	324	WRBCSS136052	537	WRBCSG136052	414	WRBCSM136052	540	WRBCSP136052
1360	620	353	WRBCSS136062	604	WRBCSG136062	457	WRBCSM136062	608	WRBCSP136062
1585	420	316	WRBCSS158042	517	WRBCSG158042	401	WRBCSM158042	520	WRBCSP158042
1585	520	348	WRBCSS158052	593	WRBCSG158052	450	WRBCSM158052	597	WRBCSP158052
1585	620	375	WRBCSS158062	664	WRBCSG158062	493	WRBCSM158062	670	WRBCSP158062
1810	420	336	WRBCSS181042	563	WRBCSG181042	431	WRBCSM181042	567	WRBCSP181042
1810	520	365	WRBCSS181052	643	WRBCSG181052	480	WRBCSM181052	648	WRBCSP181052
1810	620	400	WRBCSS181062	728	WRBCSG181062	533	WRBCSM181062	734	WRBCSP181062

Cena se počítá jako pro Ventily a příslušenství

VÝBĚR Z POTISKŮ SKEL NA OPLÁŠTĚNÍ CASE SLIM:

CASE SLIM na výšku:

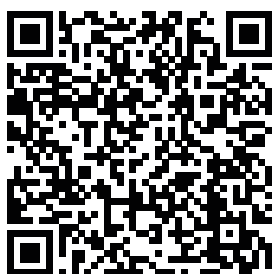

CASE SLIM horizontální:



Parametry vlastního potisku:

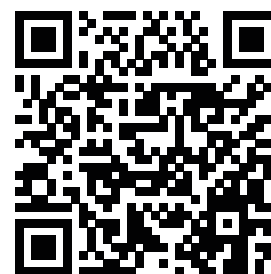



Barva je zahrnuta v ceně

výběr připojení v ceně

DOPORUČUJEME PRO PŘIPOJENÍ ZX, Z1 i Z8:



Integrovaná sada termostatická, Chrom

WRZT5G1-CR: 145 EUR
 WRZT5G2-CR: 145 EUR

Stránka: 296



Sada krycí integrovaná, Chrom

TGPCR002: 38 EUR
Stránka: 338



Topná tyč KTX4 BLUE, Chrom

WEK4B*: 137 EUR
Stránka: 252



RADIÁTOR VODNÍ / VODNĚ-ELEKTRICKÝ (DOKOUPIT TOPNOU TYČ)

Připojení:

Výška [mm] 510÷1860:

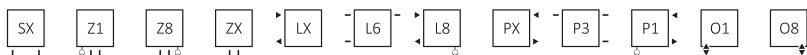

Výška [mm] 780-1860:

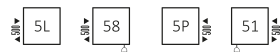

A ↕ [mm]	B ↔ [mm]	75/65/20°C [W]	55/45/20°C [W]	[W]	Barvy RAL a speciální barvy Cena bez DPH [EUR]	Kód produktu ... Kód konfigurace s. 363
510	500	304	164	300	285	WGCIT051050...
510	600	362	195	400	295	WGCIT051060...
780	500	455	245	400	318	WGCIT078050...
780	600	541	291	600	334	WGCIT078060...
1050	500	600	323	600	349	WGCIT105050...
1050	600	714	384	800	368	WGCIT105060...
1320	500	739	397	800	382	WGCIT132050...
1320	600	879	473	800	402	WGCIT132060...
1590	500	887	476	800	414	WGCIT159050...
1590	600	1055	566	1000	439	WGCIT159060...
1860	500	1032	553	1000	448	WGCIT186050...
1860	600	1227	657	1200	483	WGCIT186060...

RADIÁTOR ELEKTRICKÝ (CENA VČETNĚ NÁPLNĚ A ZVOLENÉ TOPNÉ TYČE)

Připojení:



A ↕ [mm]	B ↔ [mm]	Výkon [W]	MEG Cena bez DPH [EUR]	MOA/DRY/ TDY Cena bez DPH [EUR] (MOAIR: +12 EUR) (MOABLUE: +38 EUR)	ONE Cena bez DPH [EUR] (Nezabudovaná, v 8cm profilu v barvě radiátoru)	REG 2 Cena bez DPH [EUR]	REG 3 Cena bez DPH [EUR]	SIM Cena bez DPH [EUR]	Terma Split třída I Cena bez DPH [EUR] (nezapomeňte si koupit regulátor KTX)	Smart Split třída I Cena bez DPH [EUR] (nezapomeňte si koupit SMART Wi-Fi regulátor VEO)	Kód produktu ... Kód konfigurace s. 366
510	500	300	380	387	407	357	367	348	333	333	WLCIT051050...
510	600	400	389	397	416	367	377	357	343	343	WLCIT051060...
780	500	400	413	420	440	391	400	381	366	366	WLCIT078050...
780	600	600	429	436	456	407	416	397	382	382	WLCIT078060...
1050	500	600	443	451	471	421	431	412	397	397	WLCIT105050...
1050	600	800	463	471	490	441	451	431	416	416	WLCIT105060...
1320	500	800	477	484	504	455	464	445	430	430	WLCIT132050...
1320	600	800	496	504	523	474	484	464	450	450	WLCIT132060...
1590	500	800	509	516	536	487	496	477	462	462	WLCIT159050...
1590	600	1000	533	541	560	511	521	501	487	487	WLCIT159060...
1860	500	1000	543	550	570	521	531	511	496	496	WLCIT186050...
1860	600	1200	576	584	603	554	564	544	530	530	WLCIT186060...

City One



Barva je zahrnuta v ceně



výběr připojení v ceně



TRÍDA I



IPx5



2h/1



SADA OBSAHUJE:

Radiátor se zabudovanou topnou tyčí One. Funkce topné tyče ONE: Stránka 209.

DOPORUČUJEME PRO PŘIPOJENÍ S1 i S8:



Integrovaná sada termostatická s ponornou trubicí, Chrom

WRZT5G5-CR: 151EUR

WRZT5G6-CR: 151EUR

Stránka: 298



Sada krycí integrovaná, Chrom

TGPCR002: 38EUR

Stránka: 338



Regulátor TTIR1

TGRTBI001: 104EUR

Stránka: 268

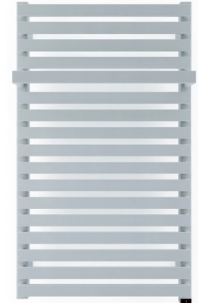

RADIÁTOR VODNĚ-ELEKTRICKÝ (CENA VČETNĚ ZABUDOVANÉ TOPNÉ TYČE ONE)

Připojení:

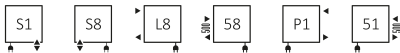

Vyber druh kabelu:

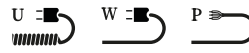

A ↕ [mm]	B ↔ [mm]	75/65/20°C [W]	55/45/20°C [W]	☺ [W]	Barvy RAL a speciální barvy Cena bez DPH [EUR]	Kód produktu ... Kód konfigurace s.364
780	500	455	245	400	415	WZCIN078050...
780	600	541	291	600	431	WZCIN078060...
1050	500	600	323	600	446	WZCIN105050...
1050	600	714	384	800	466	WZCIN105060...
1320	500	739	397	800	479	WZCIN132050...
1320	600	879	473	800	499	WZCIN132060...
1590	500	887	476	800	511	WZCIN159050...
1590	600	1055	566	1000	536	WZCIN159060...
1860	500	1032	553	1000	546	WZCIN186050...

RADIÁTOR ELEKTRICKÝ (CENA VČETNĚ NÁPLNĚ A ZABUDOVANÉ TOPNÉ TYČE ONE)

Připojení:

E1

E8

A ↕ [mm]	B ↔ [mm]	Výkon [W]	Cena bez DPH [EUR]	Kód produktu <small>... Kód konfigurace s. 365</small>
780	500	400	434	WWCIN078050...
780	600	600	450	WWCIN078060...
1050	500	600	464	WWCIN105050...
1050	600	800	484	WWCIN105060...
1320	500	800	498	WWCIN132050...
1320	600	800	517	WWCIN132060...
1590	500	800	530	WWCIN159050...
1590	600	1000	554	WWCIN159060...
1860	500	1000	564	WWCIN186050...

Cyklon V



Barva je zahrnuta v ceně



výběr připojení v ceně

DOPORUČUJEME PRO PŘIPOJENÍ YL i YP:



Integrovaná sada termostatická,
Chrom

WRZT5G1-CR: 145 EUR

WRZT5G2-CR: 145 EUR

Stránka: 296



Sada krycí integrovaná, Chrom
TGPCR002: 38 EUR

Stránka: 338



Háček bodový KUKA 70,
Chrom

WRWKUK002 KCRO: 44 EUR

Stránka: 279



RADIÁTOR VODNÍ:

Připojení:



A ↕ [mm]	B ↔ [mm]	75/65/20°C [W]	55/45/20°C [W]	Barvy RAL a speciální barvy Cena bez DPH [EUR]	Kód produktu ... Kód konfigurace s. 363
1600	410	704	375	857	WGCW160041...
1600	495	845	451	924	WGCW160049...
1900	410	832	439	936	WGCW190041...
1900	495	999	528	1 003	WGCW190049...
1900	580	1166	616	1 081	WGCW190058...

Cyklon H



Barva je zahrnuta v ceně



výběr připojení v ceně

DOPORUČUJEME PRO PŘIPOJENÍ O1 i O8:



Integrovaná sada termostatická s ponornou trubicí, Chrom



WRZT5G5-CR: 151EUR



WRZT5G6-CR: 151EUR

Stránka: 298



Sada krycí integrovaná, Chrom

TGPCR002: 38EUR

Stránka: 338



Háček bodový KUKA 70, Chrom

WRWKUK002 KCRO: 44 EUR

Stránka: 279



RADIÁTOR VODNÍ:

Připojení:



A ↕ [mm]	B ↔ [mm]	75/65/20°C [W]	55/45/20°C [W]	Barvy RAL a speciální barvy Cena bez DPH [EUR]	Kód produktu ... Kód konfigurace s. 363
410	1000	408	212	737	WGCYH041100...
410	1300	497	255	790	WGCYH041130...
410	1600	587	298	842	WGCYH041160...
495	1000	490	249	779	WGCYH049100...
495	1300	597	299	853	WGCYH049130...
495	1600	704	349	910	WGCYH049160...
580	1300	697	342	910	WGCYH058130...
580	1600	821	399	1 003	WGCYH058160...

Crystal



výběr připojení
v ceně

DOPORUČUJEME PRO PŘIPOJENÍ ZX, Z1 i Z8:



Integrovaná sada
termostatická, Chrom

WRZT5G1-CR: 145 EUR
 WRZT5G2-CR: 145 EUR

Stránka: 296



Sada krycí integrovaná,
Chrom

TGPCR002: 38 EUR

Stránka: 338



Háček bodový ZIP H 20,
Chrom

WRWZIP010 KCRO: 42 EUR

Stránka: 280



Topná tyč ONE, Chrom
WEOPX*: 127 EUR

Stránka: 250



RADIÁTOR VODNÍ / VODNĚ-ELEKTRICKÝ (DOKOUPIT TOPNOU TYČ)

Připojení:

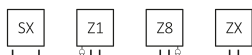

A ↕ [mm]	B ↔ [mm]	75/65/20°C [W]	55/45/20°C [W]	Barvy RAL a speciální barvy Cena bez DPH [EUR]	Kód produktu ... Kód konfigurace s. 363
480	400	135	73	201	WGCR2048040
480	500	158	86	205	WGCR2048050
480	600	181	98	209	WGCR2048060
840	400	236	128	281	WGCR2084040
840	500	276	149	287	WGCR2084050
840	600	316	171	295	WGCR2084060
1200	400	342	185	332	WGCR2120040
1200	500	400	216	338	WGCR2120050
1200	600	458	247	346	WGCR2120060
1560	400	445	239	380	WGCR2156040
1560	500	521	279	390	WGCR2156050
1560	600	595	319	400	WGCR2156060
1920	400	548	294	431	WGCR2192040
1920	500	641	344	441	WGCR2192050
1920	600	732	393	451	WGCR2192060





RADIÁTOR ELEKTRICKÝ (CENA VČETNĚ NÁPLNĚ A ZVOLENÉ TOPNÉ TYČE)

Připojení:



A ↕ [mm]	B ↔ [mm]	Výkon [W]	MEG Cena bez DPH [EUR]	MOA/DRY/ TDY Cena bez DPH [EUR] (MOA IR: +12 EUR) (MOA BLUE: +38 EUR)	ONE Cena bez DPH [EUR] (Nezabudovaná, v 8cm profilu v barvě radiátoru)	REG 2 Cena bez DPH [EUR]	REG 3 Cena bez DPH [EUR]	SIM Cena bez DPH [EUR]	Terma Split třída I Cena bez DPH [EUR] (nezapomeňte si koupit regulátor KTX)	Smart Split třída I Cena bez DPH [EUR] (nezapomeňte si koupit SMART Wi-Fi regulátor VEO)	Kód produktu ... Kód konfigurace s. 366
480	400	100	296	303	347	274	283	263	248	248	WLCR2048040
480	500	100	301	308	352	279	288	268	253	253	WLCR2048050
480	600	200	305	312	356	283	292	273	258	258	WLCR2048060
840	400	200	389	396	440	367	376	356	341	341	WLCR2084040
840	500	300	396	403	447	374	383	363	348	348	WLCR2084050
840	600	300	405	412	456	383	392	372	357	357	WLCR2084060
1200	400	400	448	455	499	426	435	415	400	400	WLCR2120040
1200	500	400	455	462	506	433	442	422	407	407	WLCR2120050
1200	600	400	464	471	515	442	451	432	417	417	WLCR2120060
1560	400	400	504	511	555	482	491	471	456	456	WLCR2156040
1560	500	600	515	522	566	493	502	483	468	468	WLCR2156050
1560	600	600	527	534	578	505	514	494	479	479	WLCR2156060
1920	400	600	563	570	614	541	550	530	515	515	WLCR2192040
1920	500	600	574	581	625	552	562	542	527	527	WLCR2192050
1920	600	800	586	593	637	564	573	553	538	538	WLCR2192060

Delfin





 Barva je zahrnuta v ceně výběr připojení v ceně

DOPORUČUJEME PRO PŘIPOJENÍ V2, V7, VP i VL:



Integrovaná sada uzavírací,

Chrom

WRZOSSC1-CR: 116 EUR

Stránka: 299



Sada krycí integrovaná,

Chrom

TGPCR002: 38 EUR

Stránka: 338



Topná tyč MOA, Chrom

WEMOA*: 105 EUR

Stránka: 259

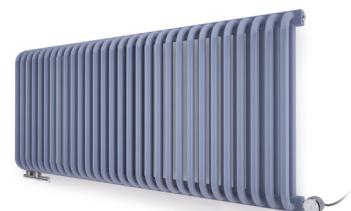

RADIÁTOR VODNÍ / VODNĚ-ELEKTRICKÝ (DOKOUPIT TOPNOU TYČ)

Připojení:

Výška [mm] 440÷1800

Výška [mm] 440÷640

Výška [mm] 1800÷2000

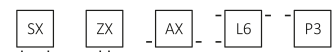
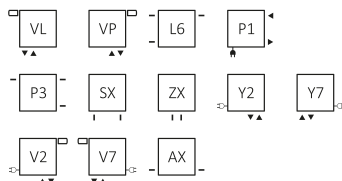

A ↑ [mm]	B ↔ [mm]	75/65/20°C [W]	55/45/20°C [W]	 [W]	Barvy RAL a speciální barvy Cena bez DPH [EUR]	Kód produktu ... Kód konfigurace s. 363
440	820	705	370	800	319	WGDLF044082...
440	1020	885	465	800	345	WGDLF044102...
440	1220	1061	556	1000	376	WGDLF044122...
540	820	846	442	800	325	WGDLF054082...
540	1020	1057	552	1000	361	WGDLF054102...
540	1220	1264	661	1200	427	WGDLF054122...
640	820	986	514	1000	383	WGDLF064082...
640	1020	1233	644	1200	427	WGDLF064102...
640	1220	1458	760	1500	472	WGDLF064122...
1800	500	1403	717	-	582	WGDLF180050...
1800	580	1623	830	-	655	WGDLF180058...
2000	500	1556	802	-	640	WGDLF200050...
2000	580	1774	909	-	726	WGDLF200058...

RADIÁTOR ELEKTRICKÝ (CENA VČETNĚ NÁPLNĚ A ZVOLENÉ TOPNÉ TYČE)

Připojení:



A ↕ [mm]	B ↔ [mm]	Výkon [W]	MEG Cena bez DPH [EUR]	MOA/DRY/ TDY Cena bez DPH [EUR] (MOAIR: +12 EUR) (MOABLUE: +38 EUR)	ONE Cena bez DPH [EUR] (Nezabudovaná, v 8cm profilu v barvě radiátoru)	REG 2 Cena bez DPH [EUR]	REG 3 Cena bez DPH [EUR]	SIM Cena bez DPH [EUR]	Terma Split třída I Cena bez DPH [EUR] (nezapomeňte si koupit regulátor KTX)	Smart Split třída I Cena bez DPH [EUR] (nezapomeňte si koupit SMART Wi-Fi regulátor VEO)	Kód produktu ... Kód konfigurace s.366
440	820	800	414	421	441	392	402	382	367	367	WLDLF044082...
440	1020	800	440	447	467	418	427	408	393	393	WLDLF044102...
440	1220	1000	471	478	498	448	458	439	424	424	WLDLF044122...
540	820	800	420	427	447	398	408	388	373	373	WLDLF054082...
540	1020	1000	456	463	483	434	443	424	409	409	WLDLF054102...
540	1220	1200	522	530	549	500	510	490	–	475	WLDLF054122...
640	820	1000	478	485	505	456	466	446	431	431	WLDLF064082...
640	1020	1200	522	530	–	500	510	490	–	475	WLDLF064102...
640	1220	1500	–	–	–	–	–	534	–	519	WLDLF064122...

Dexter



výběr připojení v ceně

DOPORUČUJEME PRO PŘIPOJENÍ SX:



Sada Dexter regulační,
chrom

TGERCD1-CR: 131EUR

TGERCD2-CR: 131EUR

Stránka: 287



Sada Dexter termostatická,
chrom

TGETCG6-CR: 174EUR

TGETCG7-CR: 174EUR

Stránka: 288



Sada krycí dvojité, Chrom

TGPCR001: 27EUR

Stránka: 337



RADIÁTOR VODNÍ / VODNĚ-ELEKTRICKÝ (DOKOUPIT TOPNOU TYČ)

Připojení:



A ↕ [mm]	B ↔ [mm]	Barva ze vzorníku RAL a speciálních barev			Galvanický povrch Chrom			Barvy RAL a speciální barvy Cena bez DPH [EUR]	Chrom Cena bez DPH [EUR]	Kód produktu ... Kód konfigurace s. 363
		75/65/20°C [W]	55/45/20°C [W]	[W]	75/65/20°C [W]	55/45/20°C [W]	[W]			
860	400	323	174	300	225	117	200	264	479	WGDEX086040...
860	500	394	212	400	281	147	300	271	502	WGDEX086050...
860	600	464	250	400	337	176	400	281	537	WGDEX086060...
1220	400	440	237	400	298	155	300	307	641	WGDEX122040...
1220	500	541	291	600	373	194	400	318	665	WGDEX122050...
1220	600	640	344	600	448	233	400	334	710	WGDEX122060...
1760	400	618	332	600	421	218	400	404	773	WGDEX176040...
1760	500	762	409	800	526	273	600	420	804	WGDEX176050...
1760	600	906	487	1000	631	327	600	440	865	WGDEX176060...

RADIÁTOR ELEKTRICKÝ (CENA VČETNĚ NÁPLNĚ A ZVOLENÉ TOPNÉ TYČE)

Připojení:



A ↕ [mm]	B ↔ [mm]	Výkon [W]		MEG Cena bez DPH [EUR]		MOA/DRY/TDY Cena bez DPH [EUR] (MOAIR: + 12 EUR) (MOABLU: + 38 EUR)		ONE Cena bez DPH [EUR] (Nezabudovaná, v 8cm profilu v barvě radiátoru)		REG 2 Cena bez DPH [EUR]		REG 3 Cena bez DPH [EUR]		SIM Cena bez DPH [EUR]		Terma Split třída I Cena bez DPH [EUR] (nezapomeňte si koupit regulátor KTX)		Smart Split třída I Cena bez DPH [EUR] (nezapomeňte si koupit SMART Wi-Fi regulátor VEO)		Kód produktu ... Kód konfigurace s. 366
		Barva	Chrom	Barvy RAL a speciální barvy	Chrom	Barvy RAL a speciální barvy	Chrom	Barvy RAL a speciální barvy	Chrom	Barvy RAL a speciální barvy	Chrom	Barvy RAL a speciální barvy	Chrom	Barvy RAL a speciální barvy	Chrom	Barvy RAL a speciální barvy	Chrom			
860	400	400	200	359	574	366	581	386	601	336	552	346	562	327	542	312	527	312	527	WLDEX086040...
860	500	400	300	366	597	373	605	393	624	344	575	354	585	334	565	319	550	319	550	WLDEX086050...
860	600	600	400	376	632	383	639	403	659	354	609	364	619	344	600	329	585	329	585	WLDEX086060...
1220	400	400	300	402	736	409	743	429	763	380	714	389	724	370	704	355	689	355	689	WLDEX122040...
1220	500	600	400	413	759	420	767	440	787	391	737	400	747	381	728	366	713	366	713	WLDEX122050...
1220	600	800	400	429	805	436	812	456	832	407	783	416	793	397	773	382	758	382	758	WLDEX122060...
1760	400	600	400	499	868	506	875	526	895	477	846	487	855	467	836	452	821	452	821	WLDEX176040...
1760	500	800	600	515	898	522	906	542	925	493	876	502	886	483	866	468	852	468	852	WLDEX176050...
1760	600	1000	600	534	960	542	967	562	987	512	938	522	948	502	928	488	913	488	913	WLDEX176060...

Dexter One



výběr připojení
v ceně



SADA OBSAHUJE:

Radiátor se zabudovanou topnou tyčí One. Funkce topné tyče ONE: Stránka 209.

DOPORUČUJEME PRO PŘIPOJENÍ S1 i S8:



Integrovaná sada termostatická
s ponornou trubicí, Chrom

WRZT5G5-CR: 151EUR

WRZT5G6-CR: 151EUR

Stránka: 298



Sada krycí integrovaná, Chrom

TGPCR002: 38EUR

Stránka: 338



Regulátor TTIR1

TGRTBI001: 104EUR

Stránka: 268



RADIÁTOR VODNĚ-ELEKTRICKÝ (CENA VČETNĚ ZABUDOVANÉ TOPNÉ TYČE ONE)

Připojení:



Vyber druh kabelu:



A ↕ [mm]	B ↔ [mm]	Barva ze vzorníku RAL a speciálních barev			Galvanický povrch Chrom			Barvy RAL a speciální barvy Cena bez DPH [EUR]	Chrom Cena bez DPH [EUR]	Kód produktu ... Kód konfigurace s. 364
		75/65/20°C [W]	55/45/20°C [W]	[W]	75/65/20°C [W]	55/45/20°C [W]	[W]			
860	400	323	174	300	225	117	200	361	576	WZDEN086040...
860	500	394	212	400	281	147	300	368	600	WZDEN086050...
860	600	464	250	400	337	176	400	378	634	WZDEN086060...
1220	400	440	237	400	298	155	300	404	739	WZDEN122040...
1220	500	541	291	600	373	194	400	415	762	WZDEN122050...
1220	600	640	344	600	448	233	400	431	807	WZDEN122060...
1760	400	618	332	600	421	218	400	501	870	WZDEN176040...
1760	500	762	409	800	526	273	600	517	901	WZDEN176050...
1760	600	906	487	1000	631	327	600	537	962	WZDEN176060...

Dexter One

RADIÁTOR ELEKTRICKÝ (CENA VČETNĚ NÁPLNĚ A ZABUDOVANÉ TOPNÉ TYČE ONE)

Připojení:

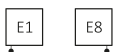

A ↕ [mm]	B ↔ [mm]	Výkon [W]		Barvy RAL a speciální barvy Cena bez DPH [EUR]	Chrom Cena bez DPH [EUR]	Kód produktu ... Kód konfigurace s. 365
		Barva	Chrom			
860	400	400	200	380	595	WWDEN086040...
860	500	400	300	387	618	WWDEN086050...
860	600	600	400	397	653	WWDEN086060...
1220	400	400	300	423	757	WWDEN122040...
1220	500	600	400	434	780	WWDEN122050...
1220	600	800	400	450	826	WWDEN122060...
1760	400	600	400	520	889	WWDEN176040...
1760	500	800	600	536	919	WWDEN176050...
1760	600	1000	600	555	981	WWDEN176060...

Diamond



DOPORUČUJEME PRO PŘIPOJENÍ SX:



Sada třísová termostatická, Chrom

WRZTCG1-CR: 143EUR

WRZTCG2-CR: 143EUR

Stránka: 294



Sada krycí dvojitá, Chrom

TGPCR001: 27EUR

Stránka: 337



Spark 1 Spark 2 Spark 3

Háček bodový SPARK

SPARK 1 - WRWSP1025 KCRO: 46 EUR

SPARK 2 - WRWSP2025 KCRO: 46 EUR

SPARK 3 - WRWSP3025 KCRO: 46 EUR

Stránka: 279



RADIÁTOR VODNÍ / VODNĚ-ELEKTRICKÝ (DOKOUPIT TOPNOU TYČ)

Připojení:

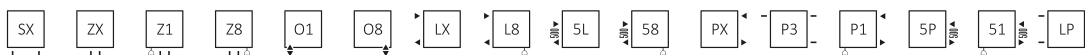

A ⇄ [mm]	B ↔ [mm]	Barva ze vzorníku RAL a speciálních barev			Galvanický povrch Chrom			Barvy RAL a speciální barvy Cena bez DPH [EUR]	Chrom Cena bez DPH [EUR]	Kód produktu ... Kód konfigurace s. 363
		75/65/20°C [W]	55/45/20°C [W]	[W]	75/65/20°C [W]	55/45/20°C [W]	[W]			
880	400	270	146	300	189	102	200	325	654	WGDIM088040...
880	500	320	174	300	224	122	200	332	676	WGDIM088050...
880	600	367	199	400	257	139	300	338	703	WGDIM088060...
1120	400	340	184	400	238	129	200	372	730	WGDIM112040...
1120	500	400	217	400	280	152	300	380	762	WGDIM112050...
1120	600	461	249	400	323	174	300	388	795	WGDIM112060...
1360	400	410	221	400	287	155	300	418	810	WGDIM136040...
1360	500	484	261	600	339	183	400	426	848	WGDIM136050...
1360	600	554	299	600	388	209	400	437	885	WGDIM136060...
1600	400	480	259	400	336	181	400	461	889	WGDIM160040...
1600	500	563	304	600	394	213	400	471	930	WGDIM160050...
1600	600	647	349	600	453	244	400	484	976	WGDIM160060...

Diamond

RADIÁTOR ELEKTRICKÝ (CENA VČETNĚ NÁPLNĚ A ZVOLENÉ TOPNÉ TYČE)

Připojení:



A ↕ [mm]	B ↔ [mm]	Výkon [W]		MEG Cena bez DPH [EUR]		MOA/DRY/TDY Cena bez DPH [EUR] (MOAIR: +12 EUR) (MOABLU: +38 EUR)		ONE Cena bez DPH [EUR] (Nezabudovaná, v 8cm profilu v barvě radiátoru)		REG 2 Cena bez DPH [EUR]		REG 3 Cena bez DPH [EUR]		SIM Cena bez DPH [EUR]		Terma Split třída I Cena bez DPH [EUR] (nezapomeňte si koupit regulátor KTX)		Smart Split třída I Cena bez DPH [EUR] (nezapomeňte si koupit SMART Wi-Fi regulátor VEO)		Kód produktu ... Kód konfigurace s. 366
				Barva	Chrom	Barvy RAL a speciální barvy	Chrom	Barvy RAL a speciální barvy	Chrom	Barvy RAL a speciální barvy	Chrom	Barvy RAL a speciální barvy	Chrom	Barvy RAL a speciální barvy	Chrom	Barvy RAL a speciální barvy	Chrom	Barvy RAL a speciální barvy	Chrom	
880	400	300	200	420	748	427	756	447	775	398	726	408	736	388	716	373	702	373	702	WLDIM088040...
880	500	300	200	426	771	434	778	453	798	404	748	414	758	394	739	380	724	380	724	WLDIM088050...
880	600	400	300	432	798	440	805	459	825	410	775	420	785	400	766	386	751	386	751	WLDIM088060...
1120	400	400	200	467	825	474	832	494	852	445	803	455	812	435	793	420	778	420	778	WLDIM112040...
1120	500	400	300	474	857	482	864	501	884	452	834	462	844	442	825	427	810	427	810	WLDIM112050...
1120	600	400	300	483	890	490	897	510	917	461	868	471	878	451	858	436	843	436	843	WLDIM112060...
1360	400	400	300	512	905	520	912	539	932	490	882	500	892	480	873	466	858	466	858	WLDIM136040...
1360	500	600	400	521	943	528	950	548	970	499	921	509	930	489	911	474	896	474	896	WLDIM136050...
1360	600	600	400	532	980	539	987	559	1 007	510	957	520	967	500	948	485	933	485	933	WLDIM136060...
1600	400	400	400	557	983	564	991	584	1 010	534	961	544	971	525	951	510	937	510	937	WLDIM160040...
1600	500	600	400	565	1 025	573	1 032	592	1 052	543	1 003	553	1 013	533	993	518	978	518	978	WLDIM160050...
1600	600	600	400	577	1 072	585	1 079	605	1 099	555	1 050	565	1 060	546	1 040	531	1 025	531	1 025	WLDIM160060...



výběr připojení v ceně

DOPORUČUJEME PRO PŘIPOJENÍ SX:



Sada tříosová termostatická s možností montáže topné tyče skrz ventil, Chrom

WRZTCG4-CR: 147 EUR

WRZTCG5-CR: 147 EUR

Stránka: 295



Sada krycí dvojitá, Chrom
TGPCR001: 27 EUR

Stránka: 337



Topná tyč REG 3, Bílá
WER3G02*: 78 EUR

Stránka: 263



Háček bodový YO!
WRWYOY001*: 4 EUR

Stránka: 280



RADIÁTOR VODNÍ / VODNĚ-ELEKTRICKÝ (DOKOUPIT TOPNOU TYČ)

Připojení:



A ↕ [mm]	B ↔ [mm]	Barva ze vzorníku RAL a speciálních barev			Galvanický povrch Chrom			Barvy RAL a speciální barvy Cena bez DPH [EUR]	Chrom Cena bez DPH [EUR]	Kód produktu ... Kód konfigurace s. 363
		75/65/20°C [W]	55/45/20°C [W]	[W]	75/65/20°C [W]	55/45/20°C [W]	[W]			
786	400	296	161	300	207	106	200	189	364	WGDOM078040...
786	500	369	199	400	258	132	300	196	394	WGDOM078050...
786	600	435	235	400	305	155	300	209	424	WGDOM078060...
1116	400	413	222	400	289	147	300	216	469	WGDOM111040...
1116	500	513	274	600	359	183	400	232	515	WGDOM111050...
1116	600	620	331	600	434	221	400	248	560	WGDOM111060...
1479	400	533	284	600	373	190	400	255	546	WGDOM147040...
1479	500	663	346	600	464	237	400	280	606	WGDOM147050...
1479	600	800	425	800	560	286	600	308	681	WGDOM147060...

RADIÁTOR ELEKTRICKÝ (CENA VČETNĚ NÁPLNĚ A ZVOLENÉ TOPNÉ TYČE)

Připojení:



A ↕ [mm]	B ↔ [mm]		Výkon [W]	MEG Cena bez DPH [EUR]		MOA/DRY/TDY Cena bez DPH [EUR] (MOAIR: + 12 EUR) (MOABLU: + 38 EUR)		ONE Cena bez DPH [EUR] (Nezabudovaná, v 8cm profilu v barvě radiátoru)		REG 2 Cena bez DPH [EUR]		REG 3 Cena bez DPH [EUR]		SIM Cena bez DPH [EUR]		Terma Split třída I Cena bez DPH [EUR] (nezapomeňte si koupit regulátor KTX)		Smart Split třída I Cena bez DPH [EUR] (nezapomeňte si koupit SMART Wi-Fi regulátor VEO)		Kód produktu ... Kód konfigurace s. 366
				Barva Chrom	Barvy PAL a speciální barvy Chrom	Barvy PAL a speciální barvy Chrom	Barvy PAL a speciální barvy Chrom	Barvy PAL a speciální barvy Chrom	Barvy PAL a speciální barvy Chrom	Barvy PAL a speciální barvy Chrom	Barvy PAL a speciální barvy Chrom	Barvy PAL a speciální barvy Chrom	Barvy PAL a speciální barvy Chrom	Barvy PAL a speciální barvy Chrom	Barvy PAL a speciální barvy Chrom	Barvy PAL a speciální barvy Chrom	Barvy PAL a speciální barvy Chrom			
786	400	300	200	282	458	290	466	309	485	260	436	270	446	250	426	236	412	236	412	WLDOM078040...
786	500	400	300	291	489	298	496	318	516	269	467	279	477	259	457	244	442	244	442	WLDOM078050...
786	600	400	300	303	518	311	526	330	546	281	496	291	506	271	487	257	472	257	472	WLDOM078060...
1116	400	400	300	311	564	318	571	338	591	289	542	298	552	279	532	264	517	264	517	WLDOM111040...
1116	500	600	400	327	609	334	617	354	637	305	587	314	597	295	577	280	563	280	563	WLDOM111050...
1116	600	600	400	343	655	350	662	370	682	321	633	330	643	311	623	296	608	296	608	WLDOM111060...
1479	400	600	400	350	639	357	646	377	666	328	617	338	627	318	607	303	592	303	592	WLDOM147040...
1479	500	600	400	375	700	382	708	402	728	352	678	362	688	343	668	328	654	328	654	WLDOM147050...
1479	600	800	600	402	775	409	783	429	803	380	753	389	763	370	743	355	729	355	729	WLDOM147060...

DOPORUČUJEME PRO PŘIPOJENÍ SX:



Sada tříosová termostatická, Chrom

 WRZTCG1-CR: 143EUR

 WRZTCG2-CR: 143EUR

Stránka: 294



Sada krycí dvojitá, Chrom

TGPCR001: 27EUR

Stránka: 337



Police EASY - Masivní dřevo

WRPEAS020 KBUK: 41EUR

WRPEAS020 KDAB: 43EUR

WRPEAS020 KTEK: 74EUR



Stránka: 273

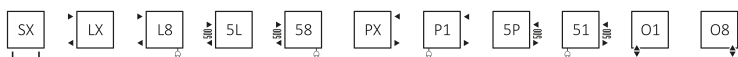

RADIÁTOR VODNÍ / VODNĚ-ELEKTRICKÝ (DOKOUPIT TOPNOU TYČ)

Připojení:



A ↓ [mm]	B ↔ [mm]	Barva ze vzorníku RAL a speciálních barev			Galvanický povrch Chrom			Barvy RAL a speciální barvy Cena bez DPH [EUR]	Chrom Cena bez DPH [EUR]	Kód produktu ... Kód konfigurace s. 363
		75/65/20°C [W]	55/45/20°C [W]	 [W]	75/65/20°C [W]	55/45/20°C [W]	 [W]			
640	200	124	68	120	87	44	120	232	322	WG EAS064020...
960	200	187	102	200	131	67	120	260	402	WG EAS096020...
1280	200	251	136	300	176	90	200	302	482	WG EAS128020...
1600	200	314	170	300	220	112	200	345	557	WG EAS160020...
1920	200	378	204	400	-	-	-	387	-	WG EAS192020...

RADIÁTOR ELEKTRICKÝ (CENA VČETNĚ NÁPLNĚ A ZVOLENÉ TOPNÉ TYČE)

Připojení:

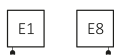

A ↓ [mm]	B ↔ [mm]	Výkon [W]		MEG Cena bez DPH [EUR]		MOA/DRY/TDY Cena bez DPH [EUR] (MOA IR: +12 EUR) (MOA BLUE: +38 EUR)		ONE Cena bez DPH [EUR] (Nezabudovaná, v 8cm profilu v barvě radiátoru)		REG 2 Cena bez DPH [EUR]		REG 3 Cena bez DPH [EUR]		SIM Cena bez DPH [EUR]		Terma Split třída I Cena bez DPH [EUR] (nezapomeňte si koupit regulátor KTX)		Smart Split třída I Cena bez DPH [EUR] (nezapomeňte si koupit SMARTWi-Fi regulátor VEO)		Kód produktu ... Kód konfigurace s. 366
		Barva	Chrom	Barvy RAL a speciální barvy	Chrom	Barvy RAL a speciální barvy	Chrom	Barvy RAL a speciální barvy	Chrom	Barvy RAL a speciální barvy	Chrom	Barvy RAL a speciální barvy	Chrom	Barvy RAL a speciální barvy	Chrom	Barvy RAL a speciální barvy	Chrom			
640	200	120	120	325	416	333	424	352	443	303	394	313	404	293	384	279	370	279	370	WLEAS064020...
960	200	200	120	355	496	362	504	382	523	333	474	343	484	323	464	308	450	308	450	WLEAS096020...
1280	200	300	200	397	575	404	582	424	602	375	553	384	563	365	543	350	528	350	528	WLEAS128020...
1600	200	300	200	440	651	447	659	467	678	418	629	427	639	408	619	393	605	393	605	WLEAS160020...
1920	200	400	-	482	-	489	-	509	-	459	-	469	-	450	-	435	-	435	-	WLEAS192020...

Easy DW (dířlicí stěna kolmá)



Barva je zahrnuta v ceně



výběr připojení v ceně

DOPORUČUJEME PRO PŘIPOJENÍ O1:



Integrovaná sada termostatická s ponornou trubicí, chrom



WRZT5G7-CR: 151 EUR

Stránka: 298



Sada krycí integrovaná, Chrom

TGPCR002: 38 EUR

Stránka: 338



Police EASY - masivní dřevo

WRPEAS020 KBUK: 41 EUR

WRPEAS020 KDAB: 43 EUR

WRPEAS020 KTEK: 74 EUR

Stránka: 273



RADIÁTOR VODNÍ

Připojení:



A ↕ [mm]	B ↔ [mm]	75/65/20°C [W]	55/45/20°C [W]	 [W]	Barvy RAL a speciální barvy Cena bez DPH [EUR]	Kód produktu ... Kód konfigurace s. 363
1660	200	314	170	300	431	WGAEAW166020...
1980	200	378	204	400	474	WGAEAW198020...

RADIÁTOR ELEKTRICKÝ (CENA VČETNĚ NÁPLNĚ A ZVOLENÉ TOPNÉ TYČE)

Připojení:



A ↕ [mm]	B ↔ [mm]	Výkon [W]	MEG Cena bez DPH [EUR]	MOA/DRY/ TDY Cena bez DPH [EUR] (MOAIR: +12 EUR) (MOABLUE: +38 EUR)	ONE Cena bez DPH [EUR] (Nezabudovaná, v 8cm profilu v barvě radiátoru)	REG 2 Cena bez DPH [EUR]	REG 3 Cena bez DPH [EUR]	SIM Cena bez DPH [EUR]	Terma Split třída I Cena bez DPH [EUR] (nezapomeňte si koupit regulátor KTX)	Smart Split třída I Cena bez DPH [EUR] (nezapomeňte si koupit SMARTWi-Fi regulátor VEO)	Kód produktu ... Kód konfigurace s. 366
1660	200	300	526	533	553	504	514	494	479	479	WLEAW166020...
1980	200	400	569	576	596	547	557	537	522	522	WLEAW198020...

Easy One



Barva je zahrnuta v ceně



výběr připojení v ceně



TRÍDA I



45-60°C/2



P-W-U



120-1000W



IR



SADA OBSAHUJE:

Radiátor se zabudovanou topnou tyčí One. Funkce topné tyče ONE: Stránka 209.

DOPORUČUJEME PRO PŘIPOJENÍ S1 i S8:



Integrovaná sada termostatická s ponornou trubící, Chrom

WRZT5G5-CR: 151 EUR

WRZT5G6-CR: 151 EUR

Stránka: 298



Sada krycí integrovaná, Chrom

TGPCR002: 38 EUR

Stránka: 338



Police EASY - Masivní dřevo

WRPEAS020 KBUK: 41 EUR

WRPEAS020 KDAB: 43 EUR

WRPEAS020 KTEK: 74 EUR

Stránka: 273



RADIÁTOR VODNĚ-ELEKTRICKÝ (CENA VČETNĚ ZABUDOVANÉ TOPNÉ TYČE ONE)

Připojení:

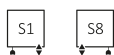

Vyber druh kabelu:

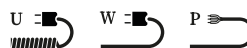

A ↓ [mm]	B ↔ [mm]	Barva ze vzorníku RAL a speciálních barev			Galvanický povrch Chrom			Barvy RAL a speciální barvy Cena bez DPH [EUR]	Chrom Cena bez DPH [EUR]	Kód produktu ... Kód konfigurace s. 364
		75/65/20°C [W]	55/45/20°C [W]	[W]	75/65/20°C [W]	55/45/20°C [W]	[W]			
960	200	187	102	200	131	67	120	357	499	WZEAN096020...
1280	200	251	136	300	176	90	200	399	577	WZEAN128020...
1600	200	314	170	300	220	112	200	442	654	WZEAN160020...
1920	200	378	204	400	-	-	-	-	-	WZEAN192020...

RADIÁTOR ELEKTRICKÝ (CENA VČETNĚ NÁPLNĚ A ZABUDOVANÉ TOPNÉ TYČE ONE)

Připojení:



A ↓ [mm]	B ↔ [mm]	Výkon [W]		Barvy RAL a speciální barvy Cena bez DPH [EUR]	Chrom Cena bez DPH [EUR]	Kód produktu ... Kód konfigurace s. 365
		Barva	Chrom			
960	200	200	120	376	517	WWEAN096020...
1280	200	300	200	418	596	WWEAN128020...
1600	200	300	200	461	672	WWEAN160020...
1920	200	400	-	502	-	WWEAN192020...

Fiona



výběr připojení v ceně

DOPORUČUJEME PRO PŘIPOJENÍ SX:



Sada tříosová termostatická, Chrom

WRZTCG1-CR: 143EUR

WRZTCG2-CR: 143EUR

Stránka: 294



Sada krycí dvojitá, Chrom

TGPCR001: 27EUR

Stránka: 337



Háček bodový YO!

WRWYOY001*: 4EUR

Stránka: 280





RADIÁTOR VODNÍ / VODNĚ-ELEKTRICKÝ (DOKOUPIT TOPNOU TYČ)

Připojení:



A ↕ [mm]	B ↔ [mm]	Barva ze vzorníku RAL a speciálních barev			Galvanický povrch Chrom			Barvy RAL a speciální barvy Cena bez DPH [EUR]	Chrom Cena bez DPH [EUR]	Kód produktu ... Kód konfigurace s. 363
		75/65/20°C [W]	55/45/20°C [W]	[W]	75/65/20°C [W]	55/45/20°C [W]	[W]			
660	400	241	128	300	169	90	200	180	349	WGFIN066040...
660	430	255	136	300	179	95	200	183	357	WGFIN066043...
660	480	280	149	300	196	104	200	185	370	WGFIN066048...
660	500	289	154	300	202	108	200	186	375	WGFIN066050...
660	530	304	162	300	212	113	200	190	383	WGFIN066053...
660	580	327	175	300	229	123	200	194	400	WGFIN066058...
660	600	336	180	400	235	126	200	195	404	WGFIN066060...
660	630	350	188	400	245	132	300	198	413	WGFIN066063...
660	680	373	200	400	261	140	300	200	426	WGFIN066068...
900	400	322	172	300	225	120	200	195	400	WGFIN090040...
900	430	342	182	400	240	127	300	198	410	WGFIN090043...
900	480	375	200	400	262	140	300	202	429	WGFIN090048...
900	500	388	206	400	272	144	300	205	435	WGFIN090050...
900	530	407	217	400	285	152	300	207	445	WGFIN090053...
900	580	438	234	400	307	164	300	211	475	WGFIN090058...
900	600	451	241	400	316	169	300	214	479	WGFIN090060...
900	630	469	251	400	329	176	300	217	493	WGFIN090063...
900	680	500	267	600	350	187	400	222	509	WGFIN090068...
1140	400	405	216	400	284	151	300	214	477	WGFIN114040...

Fiona

A ↕ [mm]	B ↔ [mm]	Barva ze vzorníku RAL a speciálních barev			Galvanický povrch Chrom			Barvy RAL a speciální barvy Cena bez DPH [EUR]	Chrom Cena bez DPH [EUR]	Kód produktu ... Kód konfigurace s. 363
		75/65/20°C [W]	55/45/20°C [W]	 [W]	75/65/20°C [W]	55/45/20°C [W]	 [W]			
1140	430	430	228	400	301	160	300	216	488	WGFIN114043...
1140	480	471	250	400	329	175	300	221	507	WGFIN114048...
1140	500	487	259	600	341	181	400	222	515	WGFIN114050...
1140	530	511	272	600	358	190	400	226	530	WGFIN114053...
1140	580	550	293	600	385	205	400	233	558	WGFIN114058...
1140	600	566	301	600	396	211	400	234	565	WGFIN114060...
1140	630	589	314	600	413	220	400	241	581	WGFIN114063...
1140	680	628	335	600	440	235	400	246	601	WGFIN114068...
1380	400	488	260	600	342	182	400	230	531	WGFIN138040...
1380	430	518	275	600	363	193	400	232	544	WGFIN138043...
1380	480	568	301	600	397	211	400	239	570	WGFIN138048...
1380	500	587	311	600	411	218	400	242	581	WGFIN138050...
1380	530	616	327	600	431	229	400	248	597	WGFIN138053...
1380	580	664	352	600	465	246	400	254	637	WGFIN138058...
1380	600	683	363	800	478	254	400	257	645	WGFIN138060...
1380	630	711	378	800	498	265	600	261	662	WGFIN138063...
1380	680	757	402	800	530	281	600	268	688	WGFIN138068...
1620	400	573	304	600	401	213	400	247	591	WGFIN162040...
1620	430	608	322	600	426	225	400	250	608	WGFIN162043...
1620	480	666	353	600	466	247	400	259	638	WGFIN162048...
1620	500	689	365	800	482	256	600	261	650	WGFIN162050...
1620	530	723	383	800	506	268	600	264	666	WGFIN162053...
1620	580	779	413	800	545	289	600	271	712	WGFIN162058...
1620	600	801	424	800	561	297	600	275	724	WGFIN162060...
1620	630	834	442	800	584	309	600	281	742	WGFIN162063...
1620	680	889	471	1000	622	330	600	289	772	WGFIN162068...
1860	400	660	350	600	-	-	-	260	-	WGFIN186040...
1860	430	700	370	800	-	-	-	265	-	WGFIN186043...
1860	480	767	405	800	-	-	-	274	-	WGFIN186048...
1860	500	793	419	800	-	-	-	277	-	WGFIN186050...
1860	530	832	440	800	-	-	-	282	-	WGFIN186053...
1860	580	897	474	1000	-	-	-	292	-	WGFIN186058...
1860	600	922	487	1000	-	-	-	296	-	WGFIN186060...
1860	630	960	507	1000	-	-	-	301	-	WGFIN186063...
1860	680	1023	541	1000	-	-	-	309	-	WGFIN186068...

RADIÁTOR ELEKTRICKÝ (CENA VČETNĚ NÁPLNĚ A ZVOLENÉ TOPNÉ TYČE)

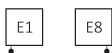

A ↓ [mm]	B ↔ [mm]	Výkon [W]		MEG Cena bez DPH [EUR]		MOA/DRY/TDY Cena bez DPH [EUR] (MOAIR: +12 EUR) (MOABLUE: +38 EUR)		ONE Cena bez DPH [EUR] (Nezabudovaná, v 8cm profilu v barvě radiátoru)		REG 2 Cena bez DPH [EUR]		REG 3 Cena bez DPH [EUR]		SIM Cena bez DPH [EUR]		Terma Split třída I Cena bez DPH [EUR] (nezapomeňte si koupit regulátor KTX)		Smart Split třída I Cena bez DPH [EUR] (nezapomeňte si koupit SMART Wi-Fi regulátor VEO)		Kód produktu ... Kód konfigurace s. 363
		Barna	Chrom	Bary BAL a speciální barvy	Chrom	Bary BAL a speciální barvy	Chrom	Bary BAL a speciální barvy	Chrom	Bary BAL a speciální barvy	Chrom	Bary BAL a speciální barvy	Chrom	Bary BAL a speciální barvy	Chrom	Bary BAL a speciální barvy	Chrom	Bary BAL a speciální barvy	Chrom	
660	400	300	120	275	443	282	451	302	471	253	421	263	431	243	412	228	397	228	397	WLFIN066040...
660	430	300	200	277	452	285	459	305	479	255	430	265	440	246	420	231	405	231	405	WLFIN066043...
660	480	300	200	280	464	287	472	307	491	258	442	268	452	248	432	233	418	233	418	WLFIN066048...
660	500	300	200	281	469	289	477	308	496	259	447	269	457	249	437	234	423	234	423	WLFIN066050...
660	530	300	200	285	478	292	485	312	505	263	456	273	466	253	446	238	431	238	431	WLFIN066053...
660	580	300	200	289	495	296	502	316	522	266	473	276	483	257	463	242	448	242	448	WLFIN066058...
660	600	400	200	290	499	297	506	317	526	268	477	277	487	258	467	243	452	243	452	WLFIN066060...
660	630	400	300	292	507	300	515	319	534	270	485	280	495	260	475	246	461	246	461	WLFIN066063...
660	680	400	300	295	521	302	528	322	548	273	499	282	509	263	489	248	474	248	474	WLFIN066068...
900	400	300	200	290	495	297	502	317	522	268	473	277	483	258	463	243	448	243	448	WLFIN090040...
900	430	400	300	292	505	300	512	319	532	270	483	280	493	260	473	246	458	246	458	WLFIN090043...
900	480	400	300	297	523	305	531	324	550	275	501	285	511	265	491	250	477	250	477	WLFIN090048...
900	500	400	300	300	530	307	537	327	557	277	507	287	517	268	498	253	483	253	483	WLFIN090050...
900	530	400	300	302	539	309	547	329	566	280	517	290	527	270	507	255	493	255	493	WLFIN090053...
900	580	400	300	306	570	313	577	333	597	284	548	293	558	274	538	259	523	259	523	WLFIN090058...
900	600	400	300	307	574	314	581	334	601	285	552	295	562	275	542	260	527	260	527	WLFIN090060...
900	630	400	300	312	586	319	593	339	613	290	564	300	574	280	554	265	539	265	539	WLFIN090063...
900	680	600	400	316	603	323	611	343	630	293	581	303	591	284	571	269	557	269	557	WLFIN090068...
1140	400	400	300	308	571	316	579	335	598	286	549	296	559	276	539	261	525	261	525	WLFIN114040...
1140	430	400	300	311	582	318	590	338	609	289	560	298	570	279	550	264	536	264	536	WLFIN114043...
1140	480	400	300	316	602	323	609	343	629	293	580	303	590	284	570	269	555	269	555	WLFIN114048...
1140	500	600	400	317	609	324	617	344	637	295	587	305	597	285	577	270	563	270	563	WLFIN114050...
1140	530	600	400	321	623	328	630	348	650	298	601	308	611	289	591	274	576	274	576	WLFIN114053...
1140	580	600	400	328	653	335	660	355	680	306	630	316	640	296	621	281	606	281	606	WLFIN114058...
1140	600	600	400	329	660	336	667	356	687	307	638	317	648	297	628	282	613	282	613	WLFIN114060...
1140	630	600	400	335	676	343	683	362	703	313	654	323	664	303	644	289	629	289	629	WLFIN114063...
1140	680	600	400	340	696	348	703	367	723	318	673	328	683	308	664	293	649	293	649	WLFIN114068...
1380	400	600	400	324	624	332	632	351	651	302	602	312	612	292	592	277	577	277	577	WLFIN138040...
1380	430	600	400	327	639	334	646	354	666	305	617	314	627	295	607	280	592	280	592	WLFIN138043...
1380	480	600	400	334	665	341	672	361	692	312	643	322	653	302	633	287	618	287	618	WLFIN138048...

Fiona

A ↓ [mm]	B ↔ [mm]	Výkon [W]		MEG		MOA/DRY/TDY		ONE		REG 2		REG 3		SIM		Terma Split třída I		Smart Split třída I		Kód produktu ... Kód konfigurace s. 363
				Cena bez DPH [EUR]		Cena bez DPH [EUR] (MOAIR: +12 EUR) (MOABLU: +38 EUR)		Cena bez DPH [EUR] (Nezabudovaná, v 8cm profilu v barvě radiátoru)		Cena bez DPH [EUR]		Cena bez DPH [EUR]		Cena bez DPH [EUR]		Cena bez DPH [EUR] (nezapomeňte si koupit regulátor KTX)		Cena bez DPH [EUR] (nezapomeňte si koupit SMART Wi-Fi regulátor VEO)		
		Bava	Chrom	Bavy PAl a speciální barvy	Chrom	Bavy PAl a speciální barvy	Chrom	Bavy PAl a speciální barvy	Chrom	Bavy PAl a speciální barvy	Chrom	Bavy PAl a speciální barvy	Chrom	Bavy PAl a speciální barvy	Chrom	Bavy PAl a speciální barvy	Chrom	Bavy PAl a speciální barvy	Chrom	
1380	500	600	400	336	676	344	683	364	703	314	654	324	664	305	644	290	629	290	629	WLFIN138050...
1380	530	600	400	343	692	350	699	370	719	321	670	330	680	311	660	296	645	296	645	WLFIN138053...
1380	580	600	400	349	731	356	739	376	758	327	709	336	719	317	699	302	684	302	684	WLFIN138058...
1380	600	800	400	351	740	359	747	378	767	329	718	339	728	319	708	305	693	305	693	WLFIN138060...
1380	630	800	600	356	757	364	764	383	784	334	735	344	745	324	725	309	710	309	710	WLFIN138063...
1380	680	800	600	362	783	370	790	389	810	340	761	350	771	330	751	316	736	316	736	WLFIN138068...
1620	400	600	400	340	686	348	693	367	713	318	664	328	673	308	654	293	639	293	639	WLFIN162040...
1620	430	600	400	345	703	352	710	372	730	323	681	333	691	313	671	298	656	298	656	WLFIN162043...
1620	480	600	400	354	732	361	740	381	759	332	710	341	720	322	700	307	686	307	686	WLFIN162048...
1620	500	800	600	356	745	364	752	383	772	334	723	344	732	324	713	309	698	309	698	WLFIN162050...
1620	530	800	600	359	761	366	768	386	788	336	739	346	748	327	729	312	714	312	714	WLFIN162053...
1620	580	800	600	366	806	373	814	393	833	344	784	354	794	334	774	319	759	319	759	WLFIN162058...
1620	600	800	600	370	819	377	826	397	846	348	796	357	806	338	787	323	772	323	772	WLFIN162060...
1620	630	800	600	376	837	383	844	403	864	354	815	364	825	344	805	329	790	329	790	WLFIN162063...
1620	680	1000	600	383	866	391	874	410	894	361	844	371	854	351	834	336	820	336	820	WLFIN162068...
1860	400	600	-	354	-	361	-	381	-	332	-	341	-	322	-	307	-	307	-	WLFIN186040...
1860	430	800	-	360	-	367	-	387	-	338	-	348	-	328	-	313	-	313	-	WLFIN186043...
1860	480	800	-	368	-	376	-	396	-	346	-	356	-	336	-	322	-	322	-	WLFIN186048...
1860	500	800	-	372	-	380	-	399	-	350	-	360	-	340	-	325	-	325	-	WLFIN186050...
1860	530	800	-	377	-	384	-	404	-	355	-	365	-	345	-	330	-	330	-	WLFIN186053...
1860	580	1000	-	387	-	394	-	414	-	365	-	375	-	355	-	340	-	340	-	WLFIN186058...
1860	600	1000	-	389	-	397	-	416	-	367	-	377	-	357	-	343	-	343	-	WLFIN186060...
1860	630	1000	-	396	-	403	-	423	-	373	-	383	-	364	-	349	-	349	-	WLFIN186063...
1860	680	1000	-	404	-	412	-	431	-	382	-	392	-	372	-	357	-	357	-	WLFIN186068...

Fiona One

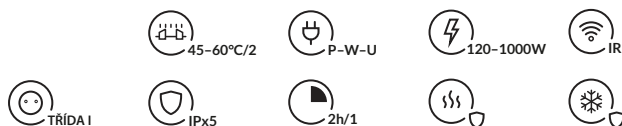

SADA OBSAHUJE:

Radiátor se zabudovanou topnou tyčí One. Funkce topné tyče ONE: Stránka 209.

DOPORUČUJEME PRO PŘIPOJENÍ S1 i S8:



Integrovaná sada termos-
tatická s ponornou trubicí,
Chrom

WRZT5G5-CR: 151EUR

WRZT5G6-CR: 151EUR

Stránka: 298



Sada krycí integrovaná,
Chrom

TGPCR002: 38EUR

Stránka: 338



Regulátor TTIR1

TGRTBI001: 104EUR

Stránka: 268



Háček bodový YO!

WRWYOY001*: 4EUR

Stránka: 280

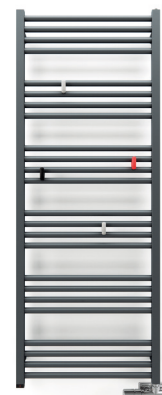

RADIÁTOR VODNĚ-ELEKTRICKÝ (CENA VČETNĚ ZABUDOVANÉ TOPNÉ TYČE ONE)

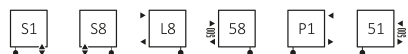

Připojení:

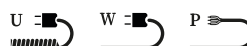

Vyber druh kabelu:



A ↕ [mm]	B ↔ [mm]	Barva ze vzorníku RAL a speciálních barev			Galvanický povrch Chrom			Barvy RAL a speciální barvy Cena bez DPH [EUR]	Chrom Cena bez DPH [EUR]	Kód produktu ... Kód konfigurace s. 364
		75/65/20°C [W]	55/45/20°C [W]		75/65/20°C [W]	55/45/20°C [W]				
900	400	305	162	400	214	113	200	292	498	WZFIE090040...
900	430	342	182	400	240	127	300	295	507	WZFIE090043...
900	480	375	200	400	262	140	300	300	526	WZFIE090048...
900	500	382	203	400	267	142	300	302	532	WZFIE090050...
900	530	407	217	400	285	152	300	305	542	WZFIE090053...
900	580	438	234	400	307	164	300	308	573	WZFIE090058...
900	600	458	244	400	321	171	300	309	576	WZFIE090060...
900	630	469	251	400	329	176	300	314	589	WZFIE090063...
900	680	500	267	400	350	187	300	318	606	WZFIE090068...
1140	400	385	204	400	270	143	300	311	574	WZFIE114040...
1140	430	430	228	400	301	160	300	313	585	WZFIE114043...
1140	480	471	250	400	329	175	300	318	605	WZFIE114048...
1140	500	481	256	400	337	179	400	319	612	WZFIE114050...
1140	530	511	272	600	358	190	400	323	625	WZFIE114053...
1140	580	550	293	600	385	205	400	330	655	WZFIE114058...
1140	600	577	307	600	404	215	400	332	662	WZFIE114060...

A ↕ [mm]	B ↔ [mm]	Barva ze vzorníku RAL a speciálních barev			Galvanický povrch Chrom			Barvy RAL a speciální barvy Cena bez DPH [EUR]	Chrom Cena bez DPH [EUR]	Kód produktu ... Kód konfigurace s. 364
		75/65/20°C [W]	55/45/20°C [W]	 [W]	75/65/20°C [W]	55/45/20°C [W]	 [W]			
1140	630	589	314	600	413	220	400	338	678	WZFIE114063...
1140	680	628	335	600	440	235	400	343	698	WZFIE114068...
1380	400	464	246	600	325	172	400	327	627	WZFIE138040...
1380	430	518	275	600	363	193	400	329	641	WZFIE138043...
1380	480	568	301	600	397	211	400	336	667	WZFIE138048...
1380	500	580	308	600	406	216	400	339	678	WZFIE138050...
1380	530	616	327	600	431	229	400	345	694	WZFIE138053...
1380	580	664	352	600	465	246	400	351	734	WZFIE138058...
1380	600	696	370	600	487	259	400	354	742	WZFIE138060...
1380	630	711	378	800	498	265	600	359	759	WZFIE138063...
1380	680	757	402	800	530	281	600	365	785	WZFIE138068...
1620	400	543	287	800	380	201	400	343	688	WZFIE162040...
1620	430	608	322	600	426	225	400	348	705	WZFIE162043...
1620	480	666	353	600	466	247	400	356	735	WZFIE162048...
1620	500	679	359	600	475	251	600	359	747	WZFIE162050...
1620	530	723	383	800	506	268	600	361	763	WZFIE162053...
1620	580	779	413	800	545	289	600	368	809	WZFIE162058...
1620	600	815	432	800	571	302	600	372	821	WZFIE162060...
1620	630	834	442	800	584	309	600	378	839	WZFIE162063...
1620	680	889	471	800	622	330	600	386	869	WZFIE162068...
1860	400	623	329	800	-	-	-	356	-	WZFIE186040...
1860	430	700	370	800	-	-	-	362	-	WZFIE186043...
1860	480	767	405	800	-	-	-	371	-	WZFIE186048...
1860	500	778	411	800	-	-	-	375	-	WZFIE186050...
1860	530	832	440	800	-	-	-	380	-	WZFIE186053...
1860	580	897	474	1000	-	-	-	389	-	WZFIE186058...
1860	600	934	493	1000	-	-	-	392	-	WZFIE186060...
1860	630	960	507	1000	-	-	-	398	-	WZFIE186063...
1860	680	1023	541	1000	-	-	-	407	-	WZFIE186068...

RADIÁTOR ELEKTRICKÝ (CENA VČETNĚ NÁPLNĚ A ZABUDOVANÉ TOPNÉ TYČE ONE)

Připojení:



A ↕ [mm]	B ↔ [mm]	Výkon [W]		Barvy RAL a speciální barvy Cena bez DPH [EUR]	Chrom Cena bez DPH [EUR]	Kód produktu ... Kód konfigurace s. 365
		Barva	Chrom			
900	400	400	200	311	516	WWFIE090040...
900	430	400	300	313	526	WWFIE090043...
900	480	400	300	318	544	WWFIE090048...
900	500	400	300	321	550	WWFIE090050...

Fiona One

A ↕ [mm]	B ↔ [mm]	Výkon [W]		Barvy RAL a speciální barvy Cena bez DPH [EUR]	Chrom Cena bez DPH [EUR]	Kód produktu ... Kód konfigurace s. 365
		Barva	Chrom			
900	530	400	300	323	560	WWFIE090053...
900	580	400	300	327	591	WWFIE090058...
900	600	400	300	328	595	WWFIE090060...
900	630	400	300	333	607	WWFIE090063...
900	680	400	300	336	624	WWFIE090068...
1140	400	400	300	329	592	WWFIE114040...
1140	430	400	300	332	603	WWFIE114043...
1140	480	400	300	336	623	WWFIE114048...
1140	500	400	400	338	630	WWFIE114050...
1140	530	600	400	341	644	WWFIE114053...
1140	580	600	400	349	673	WWFIE114058...
1140	600	600	400	350	681	WWFIE114060...
1140	630	600	400	356	697	WWFIE114063...
1140	680	600	400	361	716	WWFIE114068...
1380	400	600	400	345	645	WWFIE138040...
1380	430	600	400	348	660	WWFIE138043...
1380	480	600	400	355	686	WWFIE138048...
1380	500	600	400	357	697	WWFIE138050...
1380	530	600	400	364	713	WWFIE138053...
1380	580	600	400	370	752	WWFIE138058...
1380	600	600	400	372	761	WWFIE138060...
1380	630	800	600	377	778	WWFIE138063...
1380	680	800	600	383	804	WWFIE138068...
1620	400	800	400	361	707	WWFIE162040...
1620	430	600	400	366	724	WWFIE162043...
1620	480	600	400	375	753	WWFIE162048...
1620	500	600	600	377	766	WWFIE162050...
1620	530	800	600	380	782	WWFIE162053...
1620	580	800	600	387	827	WWFIE162058...
1620	600	800	600	391	839	WWFIE162060...
1620	630	800	600	397	858	WWFIE162063...
1620	680	800	600	404	887	WWFIE162068...
1860	400	800	–	375	–	WWFIE186040...
1860	430	800	–	381	–	WWFIE186043...
1860	480	800	–	389	–	WWFIE186048...
1860	500	800	–	393	–	WWFIE186050...
1860	530	800	–	398	–	WWFIE186053...
1860	580	1000	–	408	–	WWFIE186058...
1860	600	1000	–	410	–	WWFIE186060...
1860	630	1000	–	416	–	WWFIE186063...
1860	680	1000	–	425	–	WWFIE186068...

Forte V10



Barva je zahrnuta v ceně

výběr připojení v ceně

DOPORUČUJEME PRO PŘIPOJENÍ ZX:



Integrovaná sada termostatická, Chrom

 WRZT5G1-CR: 145 EUR

 WRZT5G2-CR: 145 EUR

Stránka: 296



Sada krycí integrovaná, Chrom

TGPCR002: 38 EUR

Stránka: 338

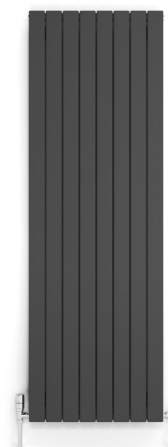

RADIÁTOR VODNÍ

Připojení:

Výška [mm] 550÷600:

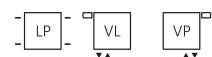

Výška [mm] 1000÷1800:

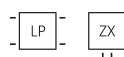

A ↑ [mm]	B ↔ [mm]	75/65/20°C [W]	55/45/20°C [W]	Barvy RAL a speciální barvy Cena bez DPH [EUR]	Kód produktu ... Kód konfigurace s. 363
550	440	281	147	268	TG10F055044...
550	588	374	195	315	TG10F055058...
550	810	515	269	383	TG10F055081...
550	1032	655	342	452	TG10F055103...
550	1254	796	416	521	TG10F055125...
600	440	304	159	279	TG10F060044...
600	588	406	212	328	TG10F060058...
600	810	558	292	402	TG10F060081...
600	1032	710	371	476	TG10F060103...
600	1254	862	451	550	TG10F060125...
1000	514	564	295	375	TG10F100051...
1000	588	645	338	411	TG10F100058...
1200	514	660	345	420	TG10F120051...
1200	588	754	394	462	TG10F120058...
1400	514	750	391	465	TG10F140051...
1400	588	857	447	513	TG10F140058...
1800	292	522	277	370	TG10F180029...
1800	366	652	345	432	TG10F180036...
1800	440	782	414	493	TG10F180044...
1800	514	913	484	554	TG10F180051...
1800	588	1043	553	616	TG10F180058...

Forte V20



Barva je zahrnuta v ceně

výběr připojení v ceně

DOPORUČUJEME PRO PŘIPOJENÍ ZX:



Integrovaná sada termostatická, Chrom

 WRZT5G1-CR: 145 EUR

 WRZT5G2-CR: 145 EUR

Stránka: 296



Sada krycí integrovaná, Chrom

TGPCR002: 38 EUR

Stránka: 338

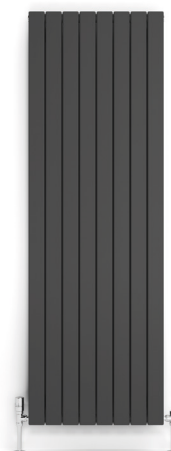

RADIÁTOR VODNÍ

Připojení:

Výška [mm] 550÷600:

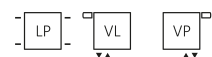

Výška [mm] 1600÷1800:

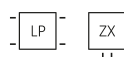

A ↕ [mm]	B ↔ [mm]	75/65/20°C [W]	55/45/20°C [W]	Barvy RAL a speciální barvy Cena bez DPH [EUR]	Kód produktu ... Kód konfigurace s. 363
550	440	429	219	338	TG20F055044...
550	588	571	292	409	TG20F055058...
550	810	786	402	514	TG20F055081...
550	1032	1000	511	620	TG20F055103...
550	1254	1214	621	727	TG20F055125...
600	440	464	237	355	TG20F060044...
600	588	619	316	431	TG20F060058...
600	810	851	435	546	TG20F060081...
600	1032	1083	553	660	TG20F060103...
600	1254	1315	672	774	TG20F060125...
1600	292	739	370	506	TG20F160029...
1600	366	924	463	601	TG20F160036...
1600	440	1108	555	696	TG20F160044...
1600	514	1293	648	791	TG20F160051...
1600	588	1478	741	886	TG20F160058...
1800	292	814	407	552	TG20F180029...
1800	366	1017	508	658	TG20F180036...
1800	440	1221	610	764	TG20F180044...
1800	514	1424	712	871	TG20F180051...
1800	588	1628	814	977	TG20F180058...

Grid



Barva je zahrnuta v ceně

výběr připojení v ceně

DOPORUČUJEME PRO PŘIPOJENÍ ZX:



Integrovaná sada termostatická, Chrom

WRZT5G1-CR: 145 EUR

WRZT5G2-CR: 145 EUR

Stránka: 296



Sada krycí integrovaná, Chrom

TGPCR002: 38 EUR

Stránka: 338



RADIÁTOR VODNÍ / VODNĚ-ELEKTRICKÝ (DOKOUPIT TOPNOU TYČ)

Připojení:

Výška [mm] 510:



Výška [mm] 630÷1830:

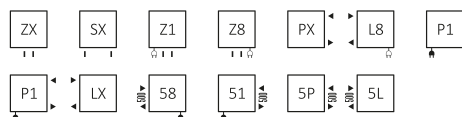

A ↓ [mm]	B ↔ [mm]	75/65/20°C [W]	55/45/20°C [W]	[W]	Barvy RAL a speciální barvy Cena bez DPH [EUR]	Kód produktu ... Kód konfigurace s.363
510	500	217	123	200	253	WGGRD051050...
630	500	262	145	300	274	WGGRD063050...
750	500	306	167	300	294	WGGRD075050...
870	500	351	189	400	313	WGGRD087050...
990	500	396	211	400	334	WGGRD099050...
1110	500	440	234	400	354	WGGRD111050...
1350	500	529	271	600	393	WGGRD135050...
1590	500	618	308	600	432	WGGRD159050...
1830	500	707	342	800	471	WGGRD183050...

RADIÁTOR ELEKTRICKÝ (CENA VČETNĚ NÁPLNĚ A ZVOLENÉ TOPNÉ TYČE)

Připojení:



A ↓ [mm]	B ↔ [mm]	Výkon [W]	MEG Cena bez DPH [EUR]	MOA/DRY/TDY Cena bez DPH [EUR] (MOAIR: +12 EUR) (MOABLU: +38 EUR)	ONE Cena bez DPH [EUR] (Nezabudovaná, v 8cm profilu v barvě radiátoru)	REG 2 Cena bez DPH [EUR]	REG 3 Cena bez DPH [EUR]	SIM Cena bez DPH [EUR]	Terma Split třída I Cena bez DPH [EUR] (nezapomeňte si koupit regulátor KTX)	Smart Split třída I Cena bez DPH [EUR] (nezapomeňte si koupit SMART Wi-Fi regulátor VEO)	Kód produktu ... Kód konfigurace s. 366
510	500	200	347	355	375	326	336	316	301	301	WLGRD051050...
630	500	300	368	376	396	347	357	337	322	322	WLGRD063050...
750	500	300	388	396	416	367	377	357	342	342	WLGRD075050...
870	500	400	407	415	435	386	396	376	361	361	WLGRD087050...
990	500	400	428	436	456	407	417	397	382	382	WLGRD099050...
1110	500	400	448	456	476	427	437	417	402	402	WLGRD111050...
1350	500	600	487	495	515	466	476	456	441	441	WLGRD135050...
1590	500	600	526	534	554	505	515	495	480	480	WLGRD159050...
1830	500	800	565	573	593	544	554	534	519	519	WLGRD183050...

Hex



Barva je zahrnuta v ceně



výběr připojení v ceně

DOPORUČUJEME PRO PŘIPOJENÍ ZX:



Integrovaná sada termostatická, Chrom

WRZT5G1-CR: 145 EUR

WRZT5G2-CR: 145 EUR

Stránka: 296



Sada krycí integrovaná, Chrom

TGPCR002: 38 EUR

Stránka: 338



RADIÁTOR VODNÍ

Připojení:

Výška [mm] 422÷502:



Výška [mm] 821÷1700:



A ⇕ [mm]	B ⇔ [mm]	75/65/20°C [W]	55/45/20°C [W]	Barvy RAL a speciální barvy Cena bez DPH [EUR]	Kód produktu ... Kód konfigurace s.363
422	711	190	102	423	WGH2X042071...
502	1126	317	169	562	WGH2X050112...
821	486	248	131	484	WGH2X082048...
1220	486	346	180	589	WGH2X122048...
1700	573	500	258	752	WGH2X170057...



Barva je zahrnuta v ceně

výběr připojení v ceně

DOPORUČUJEME PRO PŘIPOJENÍ SX:



Sada tříosová termostatická s možností montáže topné tyče skrz ventil, Chrom

WRZTCG4-CR: 147 EUR

WRZTCG5-CR: 147 EUR

Stránka: 295



Sada krycí dvojité, Chrom

TGPCR001: 27 EUR

Stránka: 337



RADIÁTOR VODNÍ / VODNĚ-ELEKTRICKÝ (DOKOUPIT TOPNOU TYČ)

Připojení:

Výška [mm] 465÷1545:

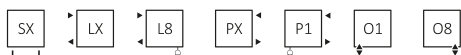

Výška [mm] 735÷1545:

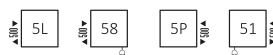

A ↓ [mm]	B ↔ [mm]	75/65/20°C [W]	55/45/20°C [W]	[W]	Barvy RAL a speciální barvy Cena bez DPH [EUR]	Kód produktu ... Kód konfigurace s. 363
465	350	284	153	300	301	WGQIN046035...
735	350	415	223	400	332	WGQIN073035...
1005	350	546	293	600	346	WGQIN100035...
1275	350	677	363	800	377	WGQIN127035...
1545	350	808	433	800	421	WGQIN154035...

RADIÁTOR ELEKTRICKÝ (CENA VČETNĚ NÁPLNĚ A ZVOLENÉ TOPNÉ TYČE)

Připojení:



A ↓ [mm]	B ↔ [mm]	Výkon [W]	MEG Cena bez DPH [EUR]	MOA/DRY/ TDY Cena bez DPH [EUR] (MOA IR: +12 EUR) (MOA BLUE: +38 EUR)	ONE Cena bez DPH [EUR] (Nezabudovaná, v 8cm profilu v barvě radiátoru)	REG 2 Cena bez DPH [EUR]	REG 3 Cena bez DPH [EUR]	SIM Cena bez DPH [EUR]	Terma Split třída I Cena bez DPH [EUR] (nezapomeňte si koupit regulátor KTX)	Smart Split třída I Cena bez DPH [EUR] (nezapomeňte si koupit SMART WI-FI regulátor VEO)	Kód produktu ... Kód konfigurace s. 366
465	350	300	396	403	423	373	383	364	349	349	WLQIN046035...
735	350	400	426	434	453	404	414	394	380	380	WLQIN073035...
1005	350	600	441	448	468	419	429	409	394	394	WLQIN100035...
1275	350	800	472	479	499	450	459	440	425	425	WLQIN127035...
1545	350	800	516	523	543	494	504	484	469	469	WLQIN154035...

Intra



Barva je zahrnuta v ceně

výběr připojení v ceně

DOPORUČUJEME PRO PŘIPOJENÍ ZX:



Integrovaná sada termostatická,

Chrom

WRZT5G1-CR: 145 EUR

WRZT5G2-CR: 145 EUR

Stránka: 296



Sada krycí integrovaná, Chrom

TGPCR002: 38 EUR

Stránka: 338



Háček bodový ZIP V 20, Chrom

WRWZIP011 KCRO: 42 EUR

Stránka: 281





RADIÁTOR VODNÍ:

Připojení:



A ↓ [mm]	B ↔ [mm]	Barva ze vzorníku RAL a speciálních barev		Galvanický povrch Chrom		Barvy RAL a speciální barvy Cena bez DPH [EUR]	Chrom Cena bez DPH [EUR]	Kód produktu ... Kód konfigurace s. 363
		75/65/20°C [W]	55/45/20°C [W]	75/65/20°C [W]	55/45/20°C [W]			
1700	410	660	346	242	452	496	871	WGINB170041...
1700	530	858	450	315	480	526	1 046	WGINB170053...
1700	650	1056	554	387	521	571	1 208	WGINB170065...
1900	410	756	388	–	–	526	–	WGINB190041...
1900	530	982	506	–	–	557	–	WGINB190053...
1900	650	1209	612	–	–	601	–	WGINB190065...

Intra M



 Barva je zahrnuta v ceně
 výběr připojení v ceně

DOPORUČUJEME PRO PŘIPOJENÍ ZX, YL, YP:



Integrovaná sada termostatická,

Chrom

 WRZT5G1-CR: 145 EUR

 WRZT5G2-CR: 145 EUR

Stránka: 296



Sada krycí integrovaná, Chrom

TGPCR002: 38 EUR

Stránka: 338



Háček bodový ZIP V 20, Chrom

WRWZIP011 KCRO: 42 EUR

Stránka: 281



RADIÁTOR VODNÍ:

Připojení:

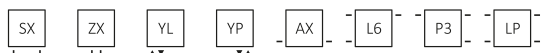

A ⇕ [mm]	B ↔ [mm]	Barva ze vzorníku RAL a speciálních barev		Galvanický povrch Chrom		Barvy RAL a speciální barvy Cena bez DPH [EUR]	Chrom Cena bez DPH [EUR]	Kód produktu ... Kód konfigurace s. 363
		75/65/20°C [W]	55/45/20°C [W]	75/65/20°C [W]	55/45/20°C [W]			
1700	440	528	277	370	192	586	871	WGINT170044...
1700	540	660	346	462	240	616	997	WGINT170054...
1700	640	925	485	647	337	661	1 230	WGINT170064...
1900	440	600	308	–	–	616	–	WGINT190044...
1900	540	762	392	–	–	645	–	WGINT190054...
1900	640	995	503	–	–	691	–	WGINT190064...

Iron D

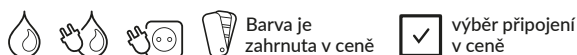

Barva je zahrnuta v ceně

výběr připojení v ceně

DOPORUČUJEME PRO PŘIPOJENÍ ZX:



Sada komplexní integrovaný ventil s T- kusem s možností připojení topné tyče skrze ventil, Chrom

WRZT5G14-CR: 188EUR

WRZT5G15-CR: 188EUR

Stránka: 297



Sada krycí integrovaná, Chrom

TGPCR002: 38EUR

Stránka: 338



RADIÁTOR VODNÍ / VODNĚ-ELEKTRICKÝ (DOKOUPIT TOPNOU TYČ)

Připojení:



RADIÁTOR SE SKLÁDÁ ZE 2 ČÁSTÍ

ČÁST 1 – RADIÁTOR

A ↕ [mm]	B ↔ [mm]	75/65/20°C [W]	55/45/20°C [W]	[W]	Barvy RAL a speciální barvy Cena bez DPH [EUR]	Kód produktu ... Kód konfigurace s. 363
730	400	453	240	400	425	WGIRD073040...
730	500	552	292	600	459	WGIRD073050...
730	600	649	344	600	486	WGIRD073060...
925	400	565	299	600	509	WGIRD092040...
925	500	689	364	800	553	WGIRD092050...
925	600	809	428	800	589	WGIRD092060...
1120	400	676	358	800	591	WGIRD112040...
1120	500	824	435	800	646	WGIRD112050...
1120	600	969	511	1000	691	WGIRD112060...
1315	400	788	417	800	667	WGIRD131040...
1315	500	960	506	1000	734	WGIRD131050...
1315	600	1128	593	1200	788	WGIRD131060...
1510	400	899	474	1000	748	WGIRD151040...
1510	500	1095	577	1000	825	WGIRD151050...
1510	600	1287	677	1200	887	WGIRD151060...
1705	400	1011	531	1000	828	WGIRD170040...
1705	500	1231	648	1200	917	WGIRD170050...
1705	600	1447	762	1500	969	WGIRD170060...

ČÁST 2 – SLOUP (KRYTÍ STOUPAČKOVÝCH PROFILŮ)

A ⇕ [mm]	B ↔ [mm]	Sloup (krytí stoupačkových profilů)	
		Barvy RAL a speciální barvy Cena bez DPH [EUR]	Kód produktu ... Kód konfigurace s. 368
730	400	78	WRCIRX073...
730	500	78	WRCIRX073...
730	600	78	WRCIRX073...
925	400	85	WRCIRX092...
925	500	85	WRCIRX092...
925	600	85	WRCIRX092...
1120	400	93	WRCIRX112...
1120	500	93	WRCIRX112...
1120	600	93	WRCIRX112...
1315	400	100	WRCIRX131...
1315	500	100	WRCIRX131...
1315	600	100	WRCIRX131...
1510	400	107	WRCIRX151...
1510	500	107	WRCIRX151...
1510	600	107	WRCIRX151...
1705	400	114	WRCIRX170...
1705	500	114	WRCIRX170...
1705	600	114	WRCIRX170...

Cena se počítá jako pro Ventily a příslušenství. Můžete také objednat ze Stránky 285

RADIÁTOR ELEKTRICKÝ (CENA VČETNĚ NÁPLNĚ A ZVOLENÉ TOPNÉ TYČE)

Připojení:



RADIÁTOR SE SKLÁDÁ ZE 2 ČÁSTÍ

ČÁST 1 – RADIÁTOR

A ⇕ [mm]	B ↔ [mm]	Výkon [W]	MEG Cena bez DPH [EUR]	MOA/DRY/ TDY Cena bez DPH [EUR] (MOAIR: + 12 EUR) (MOABLUE: + 38 EUR)	ONE Cena bez DPH [EUR] (Nezabudovaná, v 8cm profilu v barvě radiátoru)	REG 2 Cena bez DPH [EUR]	REG 3 Cena bez DPH [EUR]	SIM Cena bez DPH [EUR]	Terma Split třída I Cena bez DPH [EUR] (nezapomeňte si koupit regulátor KTX)	Smart Split třída I Cena bez DPH [EUR] (nezapomeňte si koupit SMART Wi-Fi regulátor VEO)	Kód produktu ... Kód konfigurace s. 366
925	400	600	603	610	630	581	590	570	555	555	WLIRD092040...
925	500	800	647	654	674	625	635	615	600	600	WLIRD092050...
925	600	800	683	690	710	661	670	651	636	636	WLIRD092060...
1120	400	800	685	692	712	663	672	653	638	638	WLIRD112040...
1120	500	800	740	747	767	718	728	708	693	693	WLIRD112050...
1120	600	1000	785	792	812	763	772	753	738	738	WLIRD112060...
1315	400	800	761	768	788	739	749	729	714	714	WLIRD131040...
1315	500	1000	828	835	854	806	815	795	780	780	WLIRD131050...
1315	600	1200	882	889	908	860	869	849	-	834	WLIRD131060...

Iron D

A ↕ [mm]	B ↔ [mm]	Výkon [W]	MEG Cena bez DPH [EUR]	MOA/DRY/ TDY Cena bez DPH [EUR] (MOAIR: +12 EUR) (MOABLUE: +38 EUR)	ONE Cena bez DPH [EUR] (Nezabudovaná, v 8cm profilu v barvě radiátoru)	REG 2 Cena bez DPH [EUR]	REG 3 Cena bez DPH [EUR]	SIM Cena bez DPH [EUR]	Terma Split třída I Cena bez DPH [EUR] (nezapomeňte si koupit regulátor KTX)	Smart Split třída I Cena bez DPH [EUR] (nezapomeňte si koupit SMART Wi-Fi regulátor VEO)	Kód produktu ... Kód konfigurace s. 366
1510	400	1000	842	849	869	820	829	809	794	794	WLIRD151040...
1510	500	1000	919	926	946	897	906	886	871	871	WLIRD151050...
1510	600	1200	981	988	–	959	969	949	–	934	WLIRD151060...
1705	400	1000	922	929	949	900	909	890	874	874	WLIRD170040...
1705	500	1200	1011	1018	–	989	998	978	–	963	WLIRD170050...
1705	600	1500	–	–	–	–	–	1030	–	1015	WLIRD170060...

ČÁST 2 – SLOUP (KRYTÍ STOUPAČKOVÝCH PROFILŮ)

A ↕ [mm]	B ↔ [mm]	Sloup (krytí stoupačkových profilů)	
		Barvy RAL a speciální barvy Cena bez DPH [EUR]	Kód produktu ... Kód konfigurace s. 368
925	400	85	WRCIRX092...
925	500	85	WRCIRX092...
925	600	85	WRCIRX092...
1120	400	93	WRCIRX112...
1120	500	93	WRCIRX112...
1120	600	93	WRCIRX112...
1315	400	100	WRCIRX131...
1315	500	100	WRCIRX131...
1315	600	100	WRCIRX131...
1510	400	107	WRCIRX151...
1510	500	107	WRCIRX151...
1510	600	107	WRCIRX151...
1705	400	114	WRCIRX170...
1705	500	114	WRCIRX170...
1705	600	114	WRCIRX170...

Cena se počítá jako pro Ventily a příslušenství. Můžete také objednat ze Stránky 285

Iron S

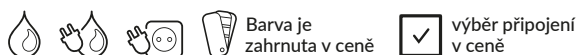

Barva je zahrnuta v ceně

výběr připojení v ceně

DOPORUČUJEME PRO PŘIPOJENÍ GD:



Sada komplexní integrovaný ventil s T- kusem s možností připojení topné tyče skrze ventil, Chrom

 WRZT5G14-CR: 188EUR

 WRZT5G15-CR: 188EUR

Stránka: 297



Sada krycí integrovaná, Chrom

TGPCR002: 38EUR

Stránka: 338

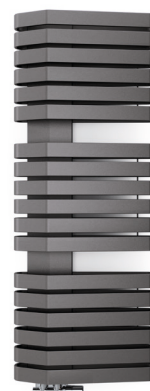

RADIÁTOR VODNÍ / VODNĚ-ELEKTRICKÝ (DOKOUPIT TOPNOU TYČ)

Připojení:



RADIÁTOR SE SKLÁDÁ ZE 2 ČÁSTÍ

ČÁST 1 – RADIÁTOR

A ↕ [mm]	B ↔ [mm]	75/65/20°C [W]	55/45/20°C [W]	 [W]	Barvy RAL a speciální barvy Cena bez DPH [EUR]	Kód produktu ... Kód konfigurace s.363
730	400	461	246	400	429	WGIRS073040...
730	500	567	302	600	457	WGIRS073050...
730	600	672	357	600	484	WGIRS073060...
925	400	578	307	600	512	WGIRS092040...
925	500	712	378	800	550	WGIRS092050...
925	600	843	446	800	586	WGIRS092060...
1120	400	695	368	800	595	WGIRS112040...
1120	500	855	452	800	642	WGIRS112050...
1120	600	1012	535	1000	687	WGIRS112060...
1315	400	810	427	800	676	WGIRS131040...
1315	500	996	525	1000	732	WGIRS131050...
1315	600	1180	622	1200	786	WGIRS131060...
1510	400	924	486	1000	762	WGIRS151040...
1510	500	1137	598	1000	823	WGIRS151050...
1510	600	1347	709	1200	885	WGIRS151060...
1705	400	1037	545	1000	839	WGIRS170040...
1705	500	1276	670	1200	914	WGIRS170050...
1705	600	1511	794	1500	985	WGIRS170060...

Iron S

ČÁST 2 – SLOUP (KRYTÍ STOUPAČKOVÝCH PROFILŮ)

A ⇕ [mm]	B ↔ [mm]	Sloup (krytí stoupačkových profilů)	
		Barvy RAL a speciální barvy Cena bez DPH [EUR]	Kód produktu ... Kód konfigurace s. 368
730	400	78	WRCIRX073...
730	500	78	WRCIRX073...
730	600	78	WRCIRX073...
925	400	85	WRCIRX092...
925	500	85	WRCIRX092...
925	600	85	WRCIRX092...
1120	400	93	WRCIRX112...
1120	500	93	WRCIRX112...
1120	600	93	WRCIRX112...
1315	400	100	WRCIRX131...
1315	500	100	WRCIRX131...
1315	600	100	WRCIRX131...
1510	400	107	WRCIRX151...
1510	500	107	WRCIRX151...
1510	600	107	WRCIRX151...
1705	400	114	WRCIRX170...
1705	500	114	WRCIRX170...
1705	600	114	WRCIRX170...

Cena se počítá jako pro Ventily a příslušenství. Můžete také objednat ze Stránky 285

RADIÁTOR ELEKTRICKÝ (CENA VČETNĚ NÁPLNĚ A ZVOLENÉ TOPNÉ TYČE)

Připojení:



RADIÁTOR SE SKLÁDÁ ZE 2 ČÁSTÍ

ČÁST 1 – RADIÁTOR

A ⇕ [mm]	B ↔ [mm]	Výkon [W]	MEG Cena bez DPH [EUR]	MOA/DRY/ TDY Cena bez DPH [EUR] (MOA IR: +12 EUR) (MOA BLUE: +38 EUR)	ONE Cena bez DPH [EUR] (Nezabudovaná, v 8cm profilu v barvě radiátoru)	REG 2 Cena bez DPH [EUR]	REG 3 Cena bez DPH [EUR]	SIM Cena bez DPH [EUR]	Terma Split třída I Cena bez DPH [EUR] (nezapomeňte si koupit regulátor KTX)	Smart Split třída I Cena bez DPH [EUR] (nezapomeňte si koupit SMARTWi-Fi regulátor VEO)	Kód produktu ... Kód konfigurace s. 366
925	400	600	606	613	632	584	593	573	558	558	WLIRS092040...
925	500	800	644	651	671	622	632	612	597	597	WLIRS092050...
925	600	800	680	687	707	658	667	647	632	632	WLIRS092060...

A ⇅ [mm]	B ↔ [mm]	Výkon [W]	MEG Cena bez DPH [EUR]	MOA/DRY/ TDY Cena bez DPH [EUR] (MOAIR: +12 EUR) (MOABLUE: +38 EUR)	ONE Cena bez DPH [EUR] (Nezabudovaná, v 8cm profilu v barvě radiátoru)	REG 2 Cena bez DPH [EUR]	REG 3 Cena bez DPH [EUR]	SIM Cena bez DPH [EUR]	Terma Split třída I Cena bez DPH [EUR] (nezapomeňte si koupit regulátor KTX)	Smart Split třída I Cena bez DPH [EUR] (nezapomeňte si koupit SMARTWi-Fi regulátor VEO)	Kód produktu ... Kód konfigurace s. 366
1120	400	800	689	696	716	667	676	657	642	642	WLIRS112040...
1120	500	800	736	743	763	714	724	704	689	689	WLIRS112050...
1120	600	1000	781	788	808	759	768	749	734	734	WLIRS112060...
1315	400	800	770	777	796	748	757	737	722	722	WLIRS131040...
1315	500	1000	826	833	853	804	814	794	779	779	WLIRS131050...
1315	600	1200	880	887	-	858	867	847	-	832	WLIRS131060...
1510	400	1000	856	862	882	833	843	823	808	808	WLIRS151040...
1510	500	1200	917	924	-	895	904	885	-	870	WLIRS151050...
1510	600	1500	-	-	-	-	-	947	-	932	WLIRS151060...
1705	400	1000	933	940	959	911	920	900	885	885	WLIRS170040...
1705	500	1200	1008	1015	-	986	995	976	-	961	WLIRS170050...
1705	600	1500	-	-	-	-	-	1046	-	1031	WLIRS170060...

ČÁST 2 – SLOUP (KRYTÍ STOUPAČKOVÝCH PROFILŮ)

A ⇅ [mm]	B ↔ [mm]	Sloup (krytí stoupačkových profilů)	
		Barvy RAL a speciální barvy Cena bez DPH [EUR]	Kód produktu ... Kód konfigurace s. 368
925	400	85	WRCIRX092...
925	500	85	WRCIRX092...
925	600	85	WRCIRX092...
1120	400	93	WRCIRX112...
1120	500	93	WRCIRX112...
1120	600	93	WRCIRX112...
1315	400	100	WRCIRX131...
1315	500	100	WRCIRX131...
1315	600	100	WRCIRX131...
1510	400	107	WRCIRX151...
1510	500	107	WRCIRX151...
1510	600	107	WRCIRX151...
1705	400	114	WRCIRX170...
1705	500	114	WRCIRX170...
1705	600	114	WRCIRX170...

Cena se počítá jako pro Ventily a příslušenství. Můžete také objednat ze Stránky 285

DOPORUČUJEME PRO PŘIPOJENÍ SX:



Sada tříosová termostatická s možností montáže topné tyče skrz ventil, Chrom

  WRZTCG4-CR: 147 EUR

  WRZTCG5-CR: 147 EUR

Stránka: 295



Sada krycí dvojité, Chrom

TGPCR001: 27 EUR

Stránka: 337



RADIÁTOR VODNÍ / VODNĚ-ELEKTRICKÝ (DOKOUPIT TOPNOU TYČ)

Připojení:



A ↑ [mm]	B ↔ [mm]	75/65/20°C [W]	55/45/20°C [W]	 [W]	Barvy RAL a speciální barvy Cena bez DPH [EUR]	Kód produktu ... Kód konfigurace s.363
555	480	324	176	300	333	WGKIO055048...
870	480	476	255	400	365	WGKIO087048...
1185	480	628	336	600	413	WGKIO118048...
1500	480	780	415	800	461	WGKIO150048...
1815	480	932	496	1000	509	WGKIO181048...

RADIÁTOR ELEKTRICKÝ (CENA VČETNĚ NÁPLNĚ A ZVOLENÉ TOPNÉ TYČE)

Připojení:



A ↑ [mm]	B ↔ [mm]	Výkon [W]	MEG Cena bez DPH [EUR]	MOA/DRY/TDY Cena bez DPH [EUR] (MOA IR: +12 EUR) (MOA BLUE: +38 EUR)	ONE Cena bez DPH [EUR] (Nezabudovaná, v 8cm profilu v barvě radiátoru)	REG 2 Cena bez DPH [EUR]	REG 3 Cena bez DPH [EUR]	SIM Cena bez DPH [EUR]	Terma Split třída I Cena bez DPH [EUR] (nezapomeňte si koupit regulátor KTX)	Smart Split třída I Cena bez DPH [EUR] (nezapomeňte si koupit SMART Wi-Fi regulátor VEO)	Kód produktu ... Kód konfigurace s.366
555	480	300	427	435	455	405	415	396	381	381	WLKIO055048...
870	480	400	459	467	487	437	447	427	413	413	WLKIO087048...
1185	480	600	507	515	534	485	495	475	461	461	WLKIO118048...
1500	480	800	555	563	582	533	543	523	509	509	WLKIO150048...
1815	480	1000	603	611	630	581	591	571	557	557	WLKIO181048...

Kioto One



Barva je zahrnuta v ceně

výběr připojení v ceně



SADA OBSAHUJE:

Radiátor se zabudovanou topnou tyčičí One. Funkce topné tyče ONE: Stránka 209.

DOPORUČUJEME PRO PŘIPOJENÍ S1 i S8:



Integrovaná sada termostatická s ponornou trubčičí, Chrom

 WRZT5G5-CR: 151 EUR

 WRZT5G6-CR: 151 EUR

Stránka: 298



Sada krycí integrovaná, Chrom

TGPCR002: 38 EUR

Stránka: 338



Regulátor TTIR1

TGRTBI001: 104 EUR

Stránka: 268



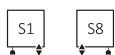

RADIÁTOR VODNĚ-ELEKTRICKÝ (CENA VČETNĚ ZABUDOVANÉ TOPNÉ TYČE ONE)

Připojení:

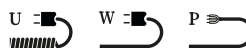

Vyber druh kabelu:



A ↕ [mm]	B ↔ [mm]	75/65/20°C [W]	55/45/20°C [W]	 [W]	Barvy RAL a speciální barvy Cena bez DPH [EUR]	Kód produktu ... Kód konfigurace s. 364
870	480	476	255	400	462	WZKIN087048...
1185	480	628	336	600	510	WZKIN118048...
1500	480	780	415	800	558	WZKIN150048...
1815	480	932	496	1000	606	WZKIN181048...

RADIÁTOR ELEKTRICKÝ (CENA VČETNĚ NÁPLNĚ A ZABUDOVANÉ TOPNÉ TYČE ONE)

Připojení:



Vyber druh kabelu:



A ↕ [mm]	B ↔ [mm]	Výkon [W]	Barvy RAL a speciální barvy Cena bez DPH [EUR]	Kód produktu ... Kód konfigurace s. 365
870	480	400	480	WWKIN087048...
1185	480	600	528	WWKIN118048...
1500	480	800	576	WWKIN150048...
1815	480	1000	624	WWKIN181048...

Lena



DOPORUČUJEME PRO PŘIPOJENÍ Z1 i Z8:



Integrovaná sada
termostatická, Chrom

WRZT5G1-CR: 145 EUR
 WRZT5G2-CR: 145 EUR

Stránka: 296



Sada krycí integrovaná,
Chrom

TGPCR002: 38 EUR

Stránka: 338



Háček bodový YO!

WRWYOY001*: 4 EUR

Stránka: 280



Topná tyč MOA, Chrom

WEMOA*: 105 EUR

Stránka: 259





RADIÁTOR VODNÍ / VODNĚ-ELEKTRICKÝ (DOKOUPIT TOPNOU TYČ)

Připojení:



A ↕ [mm]	B ↔ [mm]	Barva ze vzorníku RAL a speciálních barev			Galvanický povrch Chrom			Barvy RAL a speciální barvy Cena bez DPH [EUR]	Chrom Cena bez DPH [EUR]	Kód produktu ... Kód konfigurace s. 363
		75/65/20°C [W]	55/45/20°C [W]	[W]	75/65/20°C [W]	55/45/20°C [W]	[W]			
660	400	243	131	300	170	92	200	189	376	WGLEN066040...
660	436	262	141	300	183	99	200	193	387	WGLEN066043...
660	486	287	154	300	201	108	200	196	399	WGLEN066048...
660	500	294	158	300	206	111	200	198	403	WGLEN066050...
660	536	312	168	300	218	118	200	201	414	WGLEN066053...
660	586	337	181	400	236	127	200	205	431	WGLEN066058...
660	600	343	185	400	240	130	200	206	435	WGLEN066060...
660	636	361	194	400	253	136	300	209	445	WGLEN066063...
660	686	385	207	400	270	145	300	212	458	WGLEN066068...
900	400	326	175	300	228	123	200	207	434	WGLEN090040...
900	436	351	189	400	246	132	300	210	446	WGLEN090043...
900	486	385	207	400	270	145	300	215	463	WGLEN090048...
900	500	394	212	400	276	148	300	216	471	WGLEN090050...
900	536	418	225	400	293	158	300	220	483	WGLEN090053...
900	586	451	242	400	316	169	300	225	514	WGLEN090058...
900	600	460	247	400	322	173	300	226	518	WGLEN090060...
900	636	484	260	600	339	182	400	231	533	WGLEN090063...
900	686	516	277	600	361	194	400	236	549	WGLEN090068...
1140	400	409	219	400	286	153	300	227	515	WGLEN114040...

A ↕ [mm]	B ↔ [mm]	Barva ze vzorníku RAL a speciálních barev			Galvanický povrch Chrom			Barvy RAL a speciální barvy Cena bez DPH [EUR]	Chrom Cena bez DPH [EUR]	Kód produktu ... Kód konfigurace s. 363
		75/65/20°C [W]	55/45/20°C [W]	 [W]	75/65/20°C [W]	55/45/20°C [W]	 [W]			
1140	436	440	236	400	308	165	300	230	531	WGLEN114043...
1140	486	483	259	600	338	181	400	234	553	WGLEN114048...
1140	500	495	265	600	347	186	400	237	559	WGLEN114050...
1140	536	525	281	600	368	197	400	241	575	WGLEN114053...
1140	586	566	303	600	396	212	400	248	605	WGLEN114058...
1140	600	578	310	600	405	217	400	249	611	WGLEN114060...
1140	636	607	325	600	425	228	400	255	629	WGLEN114063...
1140	686	648	347	600	454	243	400	261	653	WGLEN114068...
1380	400	493	264	600	345	185	400	244	576	WGLEN138040...
1380	436	530	284	600	371	199	400	248	593	WGLEN138043...
1380	486	582	311	600	407	218	400	255	619	WGLEN138048...
1380	500	596	319	600	417	223	400	257	628	WGLEN138050...
1380	536	632	338	600	442	237	400	264	649	WGLEN138053...
1380	586	682	365	800	477	256	400	271	693	WGLEN138058...
1380	600	696	372	800	487	260	600	273	699	WGLEN138060...
1380	636	731	391	800	512	274	600	279	720	WGLEN138063...
1380	686	780	417	800	546	292	600	286	746	WGLEN138068...
1620	400	577	308	600	404	216	400	263	641	WGLEN162040...
1620	436	621	332	600	435	232	400	268	665	WGLEN162043...
1620	486	682	364	800	477	255	400	276	694	WGLEN162048...
1620	500	698	373	800	489	261	600	279	704	WGLEN162050...
1620	536	741	396	800	519	277	600	282	725	WGLEN162053...
1620	586	799	427	800	559	299	600	290	775	WGLEN162058...
1620	600	815	435	800	571	305	600	292	782	WGLEN162060...
1620	636	857	457	800	600	320	600	300	806	WGLEN162063...
1620	686	914	488	1000	640	342	600	308	839	WGLEN162068...
1860	400	663	354	600	–	–	–	277	–	WGLEN186040...
1860	436	714	381	800	–	–	–	284	–	WGLEN186043...
1860	486	783	417	800	–	–	–	293	–	WGLEN186048...
1860	500	802	427	800	–	–	–	296	–	WGLEN186050...
1860	536	851	453	800	–	–	–	302	–	WGLEN186053...
1860	586	918	489	1000	–	–	–	312	–	WGLEN186058...
1860	600	937	499	1000	–	–	–	316	–	WGLEN186060...
1860	636	984	524	1000	–	–	–	322	–	WGLEN186063...
1860	686	1050	559	1000	–	–	–	332	–	WGLEN186068...

RADIÁTOR ELEKTRICKÝ (CENA VČETNĚ NÁPLNĚ A ZVOLENÉ TOPNÉ TYČE)

Připojení:



A ↓ [mm]	B ↔ [mm]	Výkon [W]		MEG <small>Cena bez DPH [EUR]</small>		MOA/DRY/TDY <small>Cena bez DPH [EUR] (MOA IR: +12 EUR) (MOA BLUE: +38 EUR)</small>		ONE <small>Cena bez DPH [EUR] (Nezabudovaná, v8cm profilu v barvě radiátoru)</small>		REG 2 <small>Cena bez DPH [EUR]</small>		REG 3 <small>Cena bez DPH [EUR]</small>		SIM <small>Cena bez DPH [EUR]</small>		Terma Split třída I <small>Cena bez DPH [EUR] (nezapomeňte si koupit regulátor KTX)</small>		Smart Split třída I <small>Cena bez DPH [EUR] (nezapomeňte si koupit SMART Wi-Fi regulátor VEO)</small>		Kód produktu <small>... Kód konfigurace s.366</small>
				Barva	Chrom	Barvy RAL a speciální barvy	Chrom	Barvy RAL a speciální barvy	Chrom	Barvy RAL a speciální barvy	Chrom	Barvy RAL a speciální barvy	Chrom	Barvy RAL a speciální barvy	Chrom	Barvy RAL a speciální barvy	Chrom	Barvy RAL a speciální barvy	Chrom	
660	400	300	200	285	471	292	478	312	498	263	448	273	458	253	439	238	424	238	424	WLEN066040...
660	436	300	200	289	482	296	489	316	509	266	459	276	469	257	450	242	435	242	435	WLEN066043...
660	486	300	200	291	494	298	501	318	521	269	472	279	482	259	462	244	447	244	447	WLEN066048...
660	500	300	200	292	498	300	505	319	525	270	475	280	485	260	466	246	451	246	451	WLEN066050...
660	536	300	200	296	509	303	516	323	536	274	487	284	496	264	477	249	462	249	462	WLEN066053...
660	586	400	200	300	526	307	533	327	553	277	504	287	514	268	494	253	479	253	479	WLEN066058...
660	600	400	200	301	530	308	537	328	557	279	507	289	517	269	498	254	483	254	483	WLEN066060...
660	636	400	300	303	539	311	547	330	566	281	517	291	527	271	507	257	493	257	493	WLEN066063...
660	686	400	300	307	553	314	560	334	580	285	531	295	541	275	521	260	506	260	506	WLEN066068...
900	400	300	200	302	528	309	536	329	555	280	506	290	516	270	496	255	482	255	482	WLEN090040...
900	436	400	300	305	541	312	548	332	568	282	518	292	528	273	509	258	494	258	494	WLEN090043...
900	486	400	300	309	558	317	565	336	585	287	536	297	546	277	526	263	511	263	511	WLEN090048...
900	500	400	300	312	565	319	573	339	592	290	543	300	553	280	533	265	518	265	518	WLEN090050...
900	536	400	300	314	577	322	585	341	605	292	555	302	565	282	546	268	531	268	531	WLEN090053...
900	586	400	300	319	609	327	617	346	637	297	587	307	597	287	577	273	563	273	563	WLEN090058...
900	600	400	300	321	613	328	621	348	640	298	591	308	601	289	581	274	566	274	566	WLEN090060...
900	636	600	400	325	628	333	635	352	655	303	606	313	616	293	596	279	581	279	581	WLEN090063...
900	686	600	400	330	645	338	653	357	672	308	623	318	633	298	613	284	598	284	598	WLEN090068...
1140	400	400	300	322	609	329	617	349	637	300	587	309	597	290	577	275	563	275	563	WLEN114040...
1140	436	400	300	324	625	332	633	351	653	302	603	312	613	292	593	277	579	277	579	WLEN114043...
1140	486	600	400	329	648	336	655	356	675	307	625	317	635	297	616	282	601	282	601	WLEN114048...
1140	500	600	400	332	654	339	661	359	681	309	632	319	641	300	622	285	607	285	607	WLEN114050...
1140	536	600	400	335	671	343	678	362	698	313	649	323	659	303	639	289	624	289	624	WLEN114053...
1140	586	600	400	343	699	350	707	370	726	321	677	330	687	311	667	296	653	296	653	WLEN114058...
1140	600	600	400	344	705	351	713	371	732	322	683	332	693	312	673	297	659	297	659	WLEN114060...
1140	636	600	400	350	724	357	731	377	751	328	702	338	712	318	692	303	677	303	677	WLEN114063...
1140	686	600	400	356	747	364	755	383	774	334	725	344	735	324	715	309	700	309	700	WLEN114068...

A ⇕ [mm]	B ⇔ [mm]	Výkon [W]		MEG Cena bez DPH [EUR]		MOA/DRY/TDY Cena bez DPH [EUR] (MOAIR: +12 EUR) (MOABLU: +38 EUR)		ONE Cena bez DPH [EUR] (Nezabudovaná, v8cm profilu v barvé radiátoru)		REG 2 Cena bez DPH [EUR]		REG 3 Cena bez DPH [EUR]		SIM Cena bez DPH [EUR]		Terma Split trída I Cena bez DPH [EUR] (nezapomeňte si kúpiť regulátor KTX)		Smart Split trída I Cena bez DPH [EUR] (nezapomeňte si kúpiť SMART Wi-Fi regulátor VEO)		Kód produktu ... Kód konfigurácie s.366
		Barva	Chrom	Barvy RAL a špeciální barvy	Chrom	Barvy RAL a špeciální barvy	Chrom	Barvy RAL a špeciální barvy	Chrom	Barvy RAL a špeciální barvy	Chrom	Barvy RAL a špeciální barvy	Chrom	Barvy RAL a špeciální barvy	Chrom	Barvy RAL a špeciální barvy	Chrom	Barvy RAL a špeciální barvy	Chrom	
1380	400	600	400	339	671	346	678	366	698	317	649	327	659	307	639	292	624	292	624	WLLN138040...
1380	436	600	400	343	688	350	696	370	715	321	666	330	676	311	656	296	641	296	641	WLLN138043...
1380	486	600	400	350	715	357	723	377	742	328	693	338	703	318	683	303	668	303	668	WLLN138048...
1380	500	600	400	351	723	359	730	378	750	329	700	339	710	319	691	305	676	305	676	WLLN138050...
1380	536	600	400	359	743	366	751	386	771	336	721	346	731	327	712	312	697	312	697	WLLN138053...
1380	586	800	400	366	788	373	795	393	815	344	766	354	775	334	756	319	741	319	741	WLLN138058...
1380	600	800	600	367	794	375	801	394	821	345	772	355	782	335	762	321	747	321	747	WLLN138060...
1380	636	800	600	373	815	381	822	400	842	351	793	361	803	341	783	327	768	327	768	WLLN138063...
1380	686	800	600	381	842	388	849	408	869	359	820	368	830	349	810	334	795	334	795	WLLN138068...
1620	400	600	400	357	737	365	745	384	764	335	715	345	725	325	705	311	691	311	691	WLLN162040...
1620	436	600	400	362	759	370	767	389	787	340	737	350	747	330	728	316	713	316	713	WLLN162043...
1620	486	800	400	371	789	378	796	398	816	349	767	359	777	339	757	324	742	324	742	WLLN162048...
1620	500	800	600	373	800	381	807	400	827	351	778	361	788	341	768	327	753	327	753	WLLN162050...
1620	536	800	600	377	820	384	827	404	847	355	798	365	807	345	788	330	773	330	773	WLLN162053...
1620	586	800	600	384	870	392	878	412	897	362	848	372	858	352	838	338	823	338	823	WLLN162058...
1620	600	800	600	387	878	394	885	414	905	365	855	375	865	355	846	340	831	340	831	WLLN162060...
1620	636	800	600	394	902	402	909	421	929	372	880	382	890	362	870	348	855	348	855	WLLN162063...
1620	686	1000	600	403	935	410	943	430	962	381	913	391	923	371	903	356	889	356	889	WLLN162068...
1860	400	600	-	372	-	380	-	399	-	350	-	360	-	340	-	325	-	325	-	WLLN186040...
1860	436	800	-	378	-	386	-	405	-	356	-	366	-	346	-	332	-	332	-	WLLN186043...
1860	486	800	-	388	-	396	-	415	-	366	-	376	-	356	-	341	-	341	-	WLLN186048...
1860	500	800	-	391	-	398	-	418	-	368	-	378	-	359	-	344	-	344	-	WLLN186050...
1860	536	800	-	397	-	404	-	424	-	375	-	384	-	365	-	350	-	350	-	WLLN186053...
1860	586	1000	-	408	-	415	-	435	-	386	-	396	-	376	-	361	-	361	-	WLLN186058...
1860	600	1000	-	410	-	418	-	437	-	388	-	398	-	378	-	364	-	364	-	WLLN186060...
1860	636	1000	-	416	-	424	-	443	-	394	-	404	-	384	-	370	-	370	-	WLLN186063...
1860	686	1000	-	426	-	434	-	453	-	404	-	414	-	394	-	380	-	380	-	WLLN186068...

Lima



Barva je zahrnuta v ceně

výběr připojení v ceně

DOPORUČUJEME PRO PŘIPOJENÍ SX:



Sada tříosová termostatická, Chrom

WRZTCG1-CR: 143EUR

WRZTCG2-CR: 143EUR

Stránka: 294



Sada krycí dvojitá, Chrom

TGPCR001: 27EUR

Stránka: 337



Háček bodový YO!

WRWYOY001*: 4EUR

Stránka: 280



RADIÁTOR VODNÍ / VODNĚ-ELEKTRICKÝ (DOKOUPIT TOPNOU TYČ)

Připojení:

Výška [mm] 300÷1700:

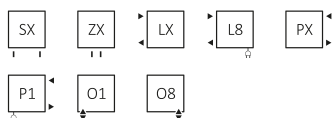

Výška [mm] 500÷1700:

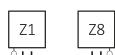

Výška [mm] 820÷1700:



A ↓ [mm]	B ↔ [mm]	Barva ze vzorníku RAL a speciálních barev			Galvanický povrch Chrom			Barvy RAL a speciální barvy Cena bez DPH [EUR]	Chrom Cena bez DPH [EUR]	Kód produktu ... Kód konfigurace s.363
		75/65/20°C [W]	55/45/20°C [W]	[W]	75/65/20°C [W]	55/45/20°C [W]	[W]			
300	1000	290	159	–	203	104	–	198	436	WGLIM030100...
300	1200	347	191	–	243	124	–	209	451	WGLIM030120...
300	1400	405	223	–	284	145	–	217	482	WGLIM030140...
500	300	144	79	120	101	51	120	161	407	WGLIM050030...
500	400	192	105	200	134	69	120	166	421	WGLIM050040...
500	500	241	131	200	169	86	200	174	436	WGLIM050050...
500	600	282	153	300	197	101	200	186	467	WGLIM050060...
500	700	324	176	300	227	116	200	189	482	WGLIM050070...
500	1000	482	262	–	337	172	–	202	496	WGLIM050100...
500	1200	578	314	–	405	206	–	217	542	WGLIM050120...
500	1400	675	367	–	473	241	–	232	586	WGLIM050140...
820	300	244	132	300	171	87	200	186	467	WGLIM082030...
820	400	325	175	300	228	116	200	194	482	WGLIM082040...
820	500	406	218	400	284	145	300	202	496	WGLIM082050...
820	600	477	256	400	334	170	400	215	511	WGLIM082060...
820	700	547	293	600	383	195	400	232	542	WGLIM082070...
1140	300	345	185	400	242	123	300	217	511	WGLIM114030...
1140	400	460	247	400	322	164	300	228	526	WGLIM114040...
1140	500	574	308	600	402	205	400	246	542	WGLIM114050...
1140	600	675	361	800	473	241	400	260	571	WGLIM114060...
1140	700	776	415	800	543	277	600	276	617	WGLIM114070...

A ↕ [mm]	B ↔ [mm]	Barva ze vzorníku RAL a speciálních barev			Galvanický povrch Chrom			Barvy RAL a speciální barvy Cena bez DPH [EUR]	Chrom Cena bez DPH [EUR]	Kód produktu ... Kód konfigurace s. 363
		75/65/20°C	55/45/20°C	☺ [W]	75/65/20°C	55/45/20°C	☺ [W]			
		[W]	[W]	[W]	[W]	[W]	[W]			
1460	300	449	240	400	314	160	300	232	571	WGLIM146030...
1460	400	599	319	600	419	214	400	246	586	WGLIM146040...
1460	500	748	399	800	524	267	600	260	601	WGLIM146050...
1460	600	879	468	800	615	314	600	274	632	WGLIM146060...
1460	700	1009	537	1000	706	360	800	306	661	WGLIM146070...
1700	300	527	280	600	369	188	400	274	617	WGLIM170030...
1700	400	703	374	800	492	251	600	289	632	WGLIM170040...
1700	500	878	466	800	615	313	600	302	661	WGLIM170050...
1700	600	1031	547	1000	722	368	800	328	721	WGLIM170060...
1700	700	1183	628	1200	828	422	800	359	782	WGLIM170070...

RADIÁTOR ELEKTRICKÝ (CENA VČETNĚ NÁPLNĚ A ZVOLENÉ TOPNÉ TYČE)



A ↕ [mm]	B ↔ [mm]	Výkon [W]	MEG Cena bez DPH [EUR]		MOA/DRY/TDY Cena bez DPH [EUR] (MOA IR: +12 EUR) (MOA BLUE: +38 EUR)		ONE Cena bez DPH [EUR] (Nezabudovaná, v 8cm profilu v barvě radiátoru)		REG 2 Cena bez DPH [EUR]		REG 3 Cena bez DPH [EUR]		SIM Cena bez DPH [EUR]		Terma Split třída I Cena bez DPH [EUR] (nezapomeňte si koupit regulátor KTX)		Smart Split třída I Cena bez DPH [EUR] (nezapomeňte si koupit SMART Wi-Fi regulátor VEO)		Kód produktu ... Kód konfigurace s. 366	
			Barva	Chrom	Barvy RAL a speciální barvy	Chrom	Barvy RAL a speciální barvy	Chrom	Barvy RAL a speciální barvy	Chrom	Barvy RAL a speciální barvy	Chrom	Barvy RAL a speciální barvy	Chrom	Barvy RAL a speciální barvy	Chrom	Barvy RAL a speciální barvy	Chrom		
			500	300	120	120	255	501	263	509	282	528	233	479	243	489	223	469		209
500	400	200	120	260	516	268	523	287	543	238	494	248	504	228	484	214	469	214	469	WLLIM050040...
500	500	200	200	269	531	276	538	296	558	247	509	257	518	237	499	222	484	222	484	WLLIM050050...
500	600	300	200	281	562	289	569	308	589	259	539	269	549	249	530	234	515	234	515	WLLIM050060...
500	700	300	200	284	576	291	584	311	603	261	554	271	564	252	544	237	530	237	530	WLLIM050070...
820	300	300	200	281	562	289	569	308	589	259	539	269	549	249	530	234	515	234	515	WLLIM082030...
820	400	300	200	289	576	296	584	316	603	266	554	276	564	257	544	242	530	242	530	WLLIM082040...
820	500	400	300	297	591	305	598	324	618	275	569	285	579	265	559	250	544	250	544	WLLIM082050...
820	600	400	400	309	606	317	613	336	633	287	584	297	593	277	574	263	559	263	559	WLLIM082060...
820	700	600	400	325	637	333	644	352	664	303	614	313	624	293	605	279	590	279	590	WLLIM082070...
1140	300	400	300	312	606	319	613	339	633	290	584	300	593	280	574	265	559	265	559	WLLIM114030...
1140	400	400	300	323	621	330	628	350	648	301	598	311	608	291	589	276	574	276	574	WLLIM114040...
1140	500	600	400	340	637	348	644	367	664	318	614	328	624	308	605	293	590	293	590	WLLIM114050...
1140	600	800	400	355	666	362	673	382	693	333	644	343	654	323	634	308	619	308	619	WLLIM114060...
1140	700	800	600	371	712	378	719	398	739	349	689	359	699	339	680	324	665	324	665	WLLIM114070...
1460	300	400	300	325	666	333	673	352	693	303	644	313	654	293	634	279	619	279	619	WLLIM146030...
1460	400	600	400	340	681	348	688	367	708	318	659	328	668	308	649	293	634	293	634	WLLIM146040...
1460	500	800	600	355	696	362	703	382	723	333	673	343	683	323	664	308	649	308	649	WLLIM146050...
1460	600	800	600	368	726	376	734	396	753	346	704	356	714	336	694	322	680	322	680	WLLIM146060...
1460	700	1000	800	399	756	407	763	426	783	377	734	387	743	367	724	352	709	352	709	WLLIM146070...
1700	300	600	400	368	712	376	719	396	739	346	689	356	699	336	680	322	665	322	665	WLLIM170030...
1700	400	800	600	383	726	391	734	410	753	361	704	371	714	351	694	336	680	336	680	WLLIM170040...
1700	500	800	600	397	756	404	763	424	783	375	734	384	743	365	724	350	709	350	709	WLLIM170050...
1700	600	1000	800	423	816	430	823	450	843	400	794	410	804	391	784	376	769	376	769	WLLIM170060...
1700	700	1200	800	453	876	461	884	480	903	431	854	441	864	421	844	407	830	407	830	WLLIM170070...

Lima One



Barva je zahrnuta v ceně



výběr připojení v ceně



TŘÍDA I



45-60°C/2



P-W-U



120-1000W



IR



IPx5



2h/1



SS



IR

SADA OBSAHUJE:

Radiátor se zabudovanou topnou tyčičí One. Funkce topné tyče ONE: Stránka 209.

DOPORUČUJEME PRO PŘIPOJENÍ S1 i S8:



Integrovaná sada termostatická s ponornou trubčičí, Chrom

WRZT5G5-CR: 151EUR

WRZT5G6-CR: 151EUR

Stránka: 298



Sada krycí integrovaná, Chrom

TGPCR002: 38EUR

Stránka: 338



Háček bodový YO!

WRWYOY001*: 4EUR

Stránka: 280



RADIÁTOR VODNĚ-ELEKTRICKÝ (CENA VČETNĚ ZABUDOVANÉ TOPNÉ TYČE ONE)

Připojení:

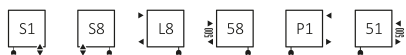

Vyber druh kabelu:

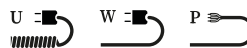

A ↓ [mm]	B ↔ [mm]	Barva ze vzorníku RAL a speciálních barev			Galvanický povrch Chrom			Barvy RAL a speciální barvy Cena bez DPH [EUR]	Chrom Cena bez DPH [EUR]	Kód produktu ... Kód konfigurace s.364
		75/65/20°C [W]	55/45/20°C [W]	☺ [W]	75/65/20°C [W]	55/45/20°C [W]	☺ [W]			
820	300	244	132	300	171	87	200	284	564	WZLIE082030...
820	400	325	175	300	228	116	200	291	579	WZLIE082040...
820	500	406	218	400	284	145	200	300	593	WZLIE082050...
820	600	477	256	400	334	170	300	312	608	WZLIE082060...
820	700	547	293	600	383	195	300	328	639	WZLIE082070...
1140	300	345	185	400	242	123	200	314	608	WZLIE114030...
1140	400	460	247	400	322	164	300	325	623	WZLIE114040...
1140	500	574	308	600	402	205	400	343	639	WZLIE114050...
1140	600	675	361	800	473	241	400	357	668	WZLIE114060...
1140	700	776	415	800	543	277	500	373	714	WZLIE114070...
1460	300	449	240	400	314	160	300	328	668	WZLIE146030...
1460	400	599	319	600	419	214	400	343	683	WZLIE146040...
1460	500	748	399	800	524	267	500	357	698	WZLIE146050...
1460	600	879	468	800	615	314	600	371	729	WZLIE146060...
1460	700	1009	537	1000	706	360	700	402	758	WZLIE146070...
1700	300	527	280	600	369	188	300	371	714	WZLIE170030...
1700	400	703	374	800	492	251	400	386	729	WZLIE170040...
1700	500	878	466	800	615	313	600	399	758	WZLIE170050...
1700	600	1031	547	1000	722	368	700	425	819	WZLIE170060...
1700	700	-	-	-	828	422	800	-	879	WZLIE170070...

Lima One

RADIÁTOR ELEKTRICKÝ (CENA VČETNĚ NÁPLNĚ A ZABUDOVANÉ TOPNÉ TYČE ONE)

Připojení:



A ↕ [mm]	B ↔ [mm]	Výkon [W]		Barvy RAL a speciální barvy Cena bez DPH [EUR]	Chrom Cena bez DPH [EUR]	Kód produktu ... Kód konfigurace s. 365
		Barva	Chrom			
820	300	300	200	302	582	WWLIE082030...
820	400	300	200	309	597	WWLIE082040...
820	500	400	300	318	612	WWLIE082050...
820	600	400	400	330	627	WWLIE082060...
820	700	600	400	346	657	WWLIE082070...
1140	300	400	300	333	627	WWLIE114030...
1140	400	400	300	344	641	WWLIE114040...
1140	500	600	400	361	657	WWLIE114050...
1140	600	800	400	376	687	WWLIE114060...
1140	700	800	600	392	732	WWLIE114070...
1460	300	400	300	346	687	WWLIE146030...
1460	400	600	400	361	702	WWLIE146040...
1460	500	800	600	376	716	WWLIE146050...
1460	600	800	600	389	747	WWLIE146060...
1460	700	1000	800	420	777	WWLIE146070...
1700	300	600	400	389	732	WWLIE170030...
1700	400	800	600	404	747	WWLIE170040...
1700	500	800	600	418	777	WWLIE170050...
1700	600	1000	800	443	837	WWLIE170060...
1700	700	-	800	-	-	WWLIE170070...

DOPORUČUJEME PRO PŘIPOJENÍ SX:



Sada tříosová termostatická,

Chrom

  WRZTCG1-CR: 143EUR

  WRZTCG2-CR: 143EUR

Stránka: 294



Sada krycí dvojitá, Chrom

TGPCR001: 27EUR

Stránka: 337



Háček bodový ZIP H 10,

Chrom

WRWZIP008 KCRO: 42EUR

Stránka: 280

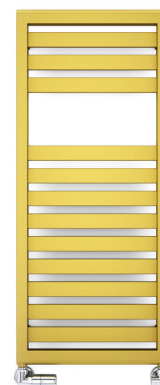

RADIÁTOR VODNÍ / VODNĚ-ELEKTRICKÝ (DOKOUPIT TOPNOU TYČ)

Připojení:

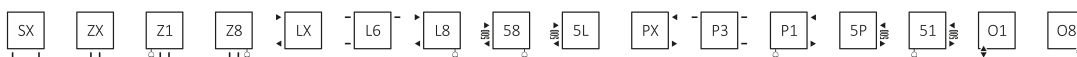

A ↕ [mm]	B ↔ [mm]	75/65/20°C [W]	55/45/20°C [W]	 [W]	Barvy RAL a speciální barvy Cena bez DPH [EUR]	Kód produktu ... Kód konfigurace s. 363
940	400	344	186	400	293	WGW51094040...
940	500	428	231	400	307	WGW51094050...
940	600	502	271	600	319	WGW51094060...
1180	400	435	234	400	316	WGW51118040...
1180	500	538	288	600	333	WGW51118050...
1180	600	629	337	600	349	WGW51118060...
1420	400	526	283	600	338	WGW51142040...
1420	500	633	340	600	357	WGW51142050...
1420	600	756	406	800	378	WGW51142060...
1660	400	617	331	600	359	WGW51166040...
1660	500	758	405	800	383	WGW51166050...
1660	600	883	470	800	407	WGW51166060...

RADIÁTOR ELEKTRICKÝ (CENA VČETNĚ NÁPLNĚ A ZVOLENÉ TOPNÉ TYČE)

Připojení:



A ↕ [mm]	B ↔ [mm]	Výkon [W]	MEG Cena bez DPH [EUR]	MOA/DRY/ TDY Cena bez DPH [EUR] (MOAIR: +12 EUR) (MOABLUE: +38 EUR)	ONE Cena bez DPH [EUR] (Nezabudovaná, v 8cm profilu v barvě radiátoru)	REG 2 Cena bez DPH [EUR]	REG 3 Cena bez DPH [EUR]	SIM Cena bez DPH [EUR]	Terma Split třída I Cena bez DPH [EUR] (nezapomeňte si koupit regulátor KTX)	Smart Split třída I Cena bez DPH [EUR] (nezapomeňte si koupit SMARTWi-Fi regulátor VEO)	Kód produktu ... Kód konfigurace s. 366
940	400	400	388	396	415	366	376	356	341	341	WLW51094040...
940	500	400	402	409	429	380	389	370	355	355	WLW51094050...
940	600	600	414	421	441	392	402	382	367	367	WLW51094060...
1180	400	400	410	418	437	388	398	378	364	364	WLW51118040...
1180	500	600	427	435	455	405	415	396	381	381	WLW51118050...
1180	600	600	443	451	471	421	431	412	397	397	WLW51118060...
1420	400	600	432	440	459	410	420	400	386	386	WLW51142040...
1420	500	600	452	459	479	430	440	420	405	405	WLW51142050...
1420	600	800	473	480	500	451	461	441	426	426	WLW51142060...
1660	400	600	453	461	480	431	441	421	407	407	WLW51166040...
1660	500	800	478	485	505	456	466	446	431	431	WLW51166050...
1660	600	800	501	509	528	479	489	469	455	455	WLW51166060...

Marlin



výběr připojení v ceně

DOPORUČUJEME PRO PŘIPOJENÍ SX:



Sada tříosová termostatická, Chrom

WRZTCG1-CR: 143EUR

WRZTCG2-CR: 143EUR

Stránka: 294



Sada krycí dvojitá, Chrom

TGPCR001: 27EUR

Stránka: 337



Háček bodový ZIP H 10, Chrom

WRWZIP008: 42EUR

Stránka: 280



RADIÁTOR VODNÍ / VODNĚ-ELEKTRICKÝ (DOKOUPIT TOPNOU TYČ)

Připojení:

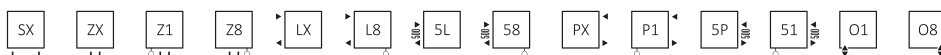

A ↓ [mm]	B ↔ [mm]	Barva ze vzorníku RAL a speciálních barev			Galvanický povrch Chrom			Barvy RAL a speciální barvy Cena bez DPH [EUR]	Chrom Cena bez DPH [EUR]	Kód produktu ... Kód konfigurace s. 363
		75/65/20°C [W]	55/45/20°C [W]	[W]	75/65/20°C [W]	55/45/20°C [W]	[W]			
600	430	244	134	300	156	84	120	207	373	WGMAR060043...
600	530	301	165	300	192	104	200	217	396	WGMAR060053...
600	630	358	196	400	228	124	200	228	415	WGMAR060063...
780	430	319	172	300	211	112	200	228	415	WGMAR078043...
780	530	393	212	400	260	137	300	238	440	WGMAR078053...
780	630	467	252	400	310	163	300	252	468	WGMAR078063...
1185	430	467	251	400	323	162	300	275	538	WGMAR118043...
1185	530	576	309	600	398	199	400	286	573	WGMAR118053...
1185	630	685	367	800	473	237	600	298	607	WGMAR118063...
1680	430	653	351	600	462	217	600	359	670	WGMAR168043...
1680	530	805	433	800	570	267	600	377	721	WGMAR168053...
1680	630	957	514	1000	677	317	800	397	774	WGMAR168063...

RADIÁTOR ELEKTRICKÝ (CENA VČETNĚ NÁPLNĚ A ZVOLENÉ TOPNÉ TYČE)

Připojení:



A ↕ [mm]	B ↔ [mm]	Výkon [W]		MEG Cena bez DPH [EUR]		MOA/DRY/TDY Cena bez DPH [EUR] (MOA IR: +12 EUR) (MOA BLUE: +38 EUR)		ONE Cena bez DPH [EUR] (Nezabudovaná, v 8cm profilu v barvě radiátoru)		REG 2 Cena bez DPH [EUR]		REG 3 Cena bez DPH [EUR]		SIM Cena bez DPH [EUR]		Terma Split třída I Cena bez DPH [EUR] (nezapomeňte si koupit regulátor KTX)		Smart Split třída I Cena bez DPH [EUR] (nezapomeňte si koupit SMART Wi-Fi regulátor VEO)		Kód produktu ... Kód konfigurace s. 366
		Banva	Chrom	Banvy PÁL a speciální banvy	Chrom	Banvy PÁL a speciální banvy	Chrom	Banvy PÁL a speciální banvy	Chrom	Banvy PÁL a speciální banvy	Chrom	Banvy PÁL a speciální banvy	Chrom	Banvy PÁL a speciální banvy	Chrom	Banvy PÁL a speciální banvy	Chrom			
600	430	300	120	302	468	309	475	329	495	280	446	290	456	270	436	255	421	255	421	WLMAR060043...
600	530	300	200	312	489	319	496	339	516	290	467	300	477	280	457	265	442	265	442	WLMAR060053...
600	630	400	200	323	510	330	517	350	537	301	488	311	498	291	478	276	463	276	463	WLMAR060063...
780	430	300	200	323	510	330	517	350	537	301	488	311	498	291	478	276	463	276	463	WLMAR078043...
780	530	400	300	333	534	340	542	360	562	311	512	321	522	301	502	286	488	286	488	WLMAR078053...
780	630	400	300	346	563	354	570	373	590	324	541	334	550	314	531	300	516	300	516	WLMAR078063...
1185	430	400	300	370	633	377	640	397	660	348	611	357	621	338	601	323	586	323	586	WLMAR118043...
1185	530	600	400	381	667	388	675	408	694	359	645	368	655	349	635	334	621	334	621	WLMAR118053...
1185	630	800	600	392	702	399	709	419	729	370	680	380	689	360	670	345	655	345	655	WLMAR118063...
1680	430	600	600	452	764	459	772	479	791	430	742	440	752	420	732	405	718	405	718	WLMAR168043...
1680	530	800	600	472	816	479	823	499	843	450	794	459	804	440	784	425	769	425	769	WLMAR168053...
1680	630	1000	800	491	869	499	876	518	896	469	847	479	857	459	837	445	822	445	822	WLMAR168063...

Marlin One



výběr připojení v ceně

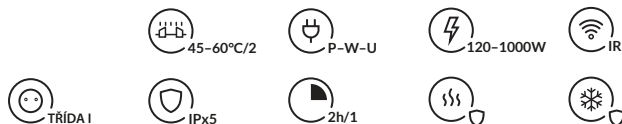

SADA OBSAHUJE:

Radiátor se zabudovanou topnou tyčí One. Funkce topné tyče ONE: Stránka 209.

DOPORUČUJEME PRO PŘIPOJENÍ S1 i S8:



Integrovaná sada termostatická s ponornou trubící, Chrom

WRZT5G5-CR: 151EUR

WRZT5G6-CR: 151EUR

Stránka: 298



Sada krycí integrovaná, Chrom

TGPCR002: 38EUR

Stránka: 338



Regulátor TTIR1

TGRTBI001: 104EUR

Stránka: 268



RADIÁTOR VODNĚ-ELEKTRICKÝ (CENA VČETNĚ ZABUDOVANÉ TOPNÉ TYČE ONE)

Připojení:

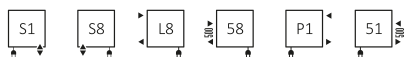

Vyber druh kabelu:

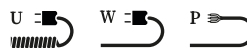

A ↕ [mm]	B ↔ [mm]	Barva ze vzorníku RAL a speciálních barev			Galvanický povrch Chrom			Barvy RAL a speciální barvy (Cena bez DPH [EUR])	Chrom (Cena bez DPH [EUR])	Kód produktu ... Kód konfigurace s. 364
		75/65/20°C [W]	55/45/20°C [W]	[W]	75/65/20°C [W]	55/45/20°C [W]	[W]			
600	430	245	134	300	156	84	120	305	471	WZMRN060043...
600	530	301	165	300	192	104	200	314	491	WZMRN060053...
600	630	358	196	400	228	124	200	325	512	WZMRN060063...
780	430	319	172	300	211	112	200	325	512	WZMRN078043...
780	530	393	212	400	260	137	300	335	537	WZMRN078053...
780	630	467	252	400	310	163	300	349	565	WZMRN078063...
1185	430	467	251	400	323	162	300	372	635	WZMRN118043...
1185	530	576	309	600	398	199	400	383	670	WZMRN118053...
1185	630	685	367	800	473	237	600	394	704	WZMRN118063...
1680	430	653	351	600	462	217	600	455	767	WZMRN168043...
1680	530	805	433	800	570	267	600	474	819	WZMRN168053...
1680	630	957	514	1000	677	317	800	494	871	WZMRN168063...

Marlin One

RADIÁTOR ELEKTRICKÝ (CENA VČETNĚ NÁPLNĚ A ZABUDOVANÉ TOPNÉ TYČE ONE)

Připojení:



A ↕ [mm]	B ↔ [mm]	Výkon [W]		Barvy RAL a speciální barvy Cena bez DPH [EUR]	Chrom Cena bez DPH [EUR]	Kód produktu ... Kód konfigurace s. 365
		Barva	Chrom			
600	430	300	120	323	489	WWMRN060043...
600	530	300	200	333	510	WWMRN060053...
600	630	400	200	344	531	WWMRN060063...
780	430	300	200	344	531	WWMRN078043...
780	530	400	300	354	555	WWMRN078053...
780	630	400	300	367	584	WWMRN078063...
1185	430	400	300	391	654	WWMRN118043...
1185	530	600	400	402	688	WWMRN118053...
1185	630	800	600	413	723	WWMRN118063...
1680	430	600	600	473	785	WWMRN168043...
1680	530	800	600	493	837	WWMRN168053...
1680	630	1000	800	512	890	WWMRN168063...

Michelle



Barva je zahrnuta v ceně výběr připojení v ceně

DOPORUČUJEME PRO PŘIPOJENÍ YL i YP:



Sada komplexní integrovaný ventil s T- kusem s možností připojení topné tyče skrze ventil, Chrom

WRZT5G14-CR: 188EUR

WRZT5G15-CR: 188EUR

Stránka: 297



Sada krycí integrovaná, Chrom

TGPCR002: 38EUR

Stránka: 338



RADIÁTOR VODNÍ / VODNĚ-ELEKTRICKÝ (DOKOUPIT TOPNOU TYČ)

Připojení:



RADIÁTOR SE SKLÁDÁ ZE 2 ČÁSTÍ

1. ČÁST – RADIÁTOR (SPIRÁLY)

A ↓ [mm]	B ↔ [mm]	Barva ze vzorníku RAL a speciálních barev			Galvanický povrch Chrom			Barvy RAL a speciální barvy Cena bez DPH [EUR]	Chrom Cena bez DPH [EUR]	Kód produktu ... Kód konfigurace s. 363
		75/65/20°C [W]	55/45/20°C [W]	[W]	75/65/20°C [W]	55/45/20°C [W]	[W]			
780	400	365	196	400	256	130	300	329	722	WGMIC078040...
780	500	455	244	400	319	162	300	348	787	WGMIC078050...
780	600	533	286	600	373	190	400	363	851	WGMIC078060...
1200	400	580	310	600	406	207	400	428	976	WGMIC120040...
1200	500	721	386	800	505	257	600	451	1 081	WGMIC120050...
1200	600	845	452	800	592	302	600	476	1 178	WGMIC120060...
1620	400	805	429	800	564	287	600	516	1 223	WGMIC162040...
1620	500	1000	533	1000	700	357	800	560	1 372	WGMIC162050...
1620	600	1172	624	1200	820	418	800	710	1 510	WGMIC162060...

2. ČÁST - SLOUP (KRYTÍ STOUPAČKOVÝCH PROFILŮ)

A ↓ [mm]	B ↔ [mm]	Sloup (krytí stoupačkových profilů)			
		Barvy RAL a speciální barvy Cena bez DPH [EUR]	Chrom Cena bez DPH [EUR]	Kód produktu (verze levá pro YL) ... Kód konfigurace s. 368	Kód produktu (verze pravá pro YP) ... Kód konfigurace s. 368
780	400	59	115	WRCMIC078L...	WRCMIC078P...
780	500	59	115	WRCMIC078L...	WRCMIC078P...
780	600	59	115	WRCMIC078L...	WRCMIC078P...
1200	400	68	153	WRCMIC120L...	WRCMIC120P...
1200	500	68	153	WRCMIC120L...	WRCMIC120P...

A ↕ [mm]	B ↔ [mm]	Sloup (krytí stoupačkových profilů)			
		Barvy RAL a speciální barvy Cena bez DPH [EUR]	Chrom Cena bez DPH [EUR]	Kód produktu (verze levá pro YL) ... Kód konfigurace s. 368	Kód produktu (verze pravá pro YP) ... Kód konfigurace s. 368
1200	600	68	153	WRCMIC120L...	WRCMIC120P...
1620	400	77	192	WRCMIC162L...	WRCMIC162P...
1620	500	77	192	WRCMIC162L...	WRCMIC162P...
1620	600	77	192	WRCMIC162L...	WRCMIC162P...

Cena se počítá jako pro Ventily a příslušenství. Můžete také objednat ze Stránky 285

RADIÁTOR ELEKTRICKÝ (CENA VČETNĚ NÁPLNĚ A ZVOLENÉ TOPNÉ TYČE)

Připojení:



RADIÁTOR SE SKLÁDÁ ZE 2 ČÁSTÍ

1. ČÁST – RADIÁTOR (SPIRÁLY)

A ↕ [mm]	B ↔ [mm]	Výkon [W]		MEG Cena bez DPH [EUR]		MOA/DRY/TDY Cena bez DPH [EUR] (MOAIR: +12 EUR) (MOABLUE: +38 EUR)		ONE Cena bez DPH [EUR] (Nezabudovaná, v 8cm profilu v barvě radiátoru)		REG 2 Cena bez DPH [EUR]		REG 3 Cena bez DPH [EUR]		SIM Cena bez DPH [EUR]		Terma Split třída I Cena bez DPH [EUR] (nezapomeňte si koupit regulátor KTX)		Smart Split třída I Cena bez DPH [EUR] (nezapomeňte si koupit SMART Wi-Fi regulátor VEO)		Kód produktu ... Kód konfigurace s. 366
		Barna	Chrom	Barvy RAL a speciální barvy	Chrom	Barvy RAL a speciální barvy	Chrom	Barvy RAL a speciální barvy	Chrom	Barvy RAL a speciální barvy	Chrom	Barvy RAL a speciální barvy	Chrom	Barvy RAL a speciální barvy	Chrom	Barvy RAL a speciální barvy	Chrom	Barvy RAL a speciální barvy	Chrom	
1200	400	600	400	522	1070	529	1077	549	1096	500	1048	509	1057	489	1037	474	1022	474	1022	WLMIC120040...
1200	500	800	600	545	1175	552	1182	572	1202	523	1153	533	1162	513	1143	498	1128	498	1128	WLMIC120050...
1200	600	800	600	569	1272	576	1279	596	1299	547	1250	557	1260	537	1240	522	1225	522	1225	WLMIC120060...
1620	400	800	600	610	1317	617	1324	637	1344	588	1295	597	1304	578	1284	563	1269	563	1269	WLMIC162040...
1620	500	1000	800	654	1466	661	1473	680	1493	632	1444	641	1454	621	1434	606	1419	606	1419	WLMIC162050...
1620	600	1200	800	803	1604	810	1611	830	1630	781	1582	791	1591	771	1571	756	1556	756	1556	WLMIC162060...

2. ČÁST - SLOUP (KRYTÍ STOUPAČKOVÝCH PROFILŮ)

A ↕ [mm]	B ↔ [mm]	Sloup (krytí stoupačkových profilů)			
		Barvy RAL a speciální barvy Cena bez DPH [EUR]	Chrom Cena bez DPH [EUR]	Kód produktu (verze levá pro E1) ... Kód konfigurace s. 368	Kód produktu (verze pravá pro E8) ... Kód konfigurace s. 368
1200	400	68	153	WRCMIC120L...	WRCMIC120P...
1200	500	68	153	WRCMIC120L...	WRCMIC120P...
1200	600	68	153	WRCMIC120L...	WRCMIC120P...
1620	400	77	192	WRCMIC162L...	WRCMIC162P...
1620	500	77	192	WRCMIC162L...	WRCMIC162P...
1620	600	77	192	WRCMIC162L...	WRCMIC162P...

Cena se počítá jako pro Ventily a příslušenství. Můžete také objednat ze Stránky 285

DOPORUČUJEME PRO PŘIPOJENÍ SX:



Sada tříosová termostatická s možností montáže topné tyče skrz ventil, Chrom

  WRZTCG4-CR: 147 EUR

  WRZTCG5-CR: 147 EUR

Stránka: 295



Sada krycí dvojité, Chrom

TGPCR001: 27 EUR

Stránka: 337

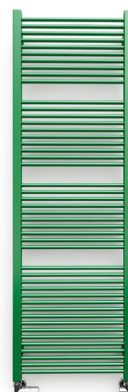

RADIÁTOR VODNÍ / VODNĚ-ELEKTRICKÝ (DOKOUPIT TOPNOU TYČ)

Připojení:

Výška [mm] 435÷1710,
Šíře [mm] 230÷530:

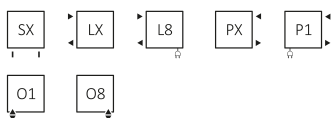

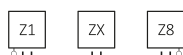

Výška [mm] 435÷1710,
Šíře [mm] 430÷530:



Výška [mm] 710÷1710,
Šíře [mm] 230÷530:



A ↕ [mm]	B ↔ [mm]	Barva ze vzorníku RAL a speciálních barev			Galvanický povrch Chrom			Barvy RAL a speciální barvy Cena bez DPH [EUR]	Chrom Cena bez DPH [EUR]	Kód produktu ... Kód konfigurace s. 363
		75/65/20°C [W]	55/45/20°C [W]	 [W]	75/65/20°C [W]	55/45/20°C [W]	 [W]			
435	430	203	106	200	142	72	120	180	300	WGMIK043043...
435	530	245	128	300	171	87	200	193	335	WGMIK043053...
460	230	122	64	120	85	44	120	135	244	WGMIK046023...
710	230	185	97	200	130	66	120	151	300	WGMIK071023...
735	430	337	176	400	236	120	200	204	408	WGMIK073043...
735	530	406	213	400	284	145	300	216	443	WGMIK073053...
960	230	247	130	300	173	88	200	171	356	WGMIK096023...
1035	430	466	245	400	326	167	300	228	491	WGMIK103043...
1035	530	563	295	600	394	201	400	241	538	WGMIK103053...
1210	230	308	162	300	216	110	200	186	412	WGMIK121023...
1335	430	593	312	600	415	212	400	241	586	WGMIK133043...
1335	530	715	376	800	501	255	600	264	659	WGMIK133053...
1460	230	367	193	400	257	131	300	201	466	WGMIK146023...
1635	430	716	377	800	501	256	600	264	682	WGMIK163043...
1635	530	864	454	800	605	308	600	287	766	WGMIK163053...
1710	230	425	224	400	298	152	300	217	521	WGMIK171023...

RADIÁTOR ELEKTRICKÝ (CENA VČETNĚ NÁPLNĚ A ZVOLENÉ TOPNÉ TYČE)

Připojení:



A ↕ [mm]	B ↔ [mm]	Výkon [W]		MEG Cena bez DPH [EUR]		MOA/DRY/TDY Cena bez DPH [EUR] (MOAIR: +12 EUR) (MOABLU: +38 EUR)		ONE Cena bez DPH [EUR] (Nezabudovaná, v 8cm profilu v barvě radiátoru)		REG 2 Cena bez DPH [EUR]		REG 3 Cena bez DPH [EUR]		SIM Cena bez DPH [EUR]		Terma Split třída I Cena bez DPH [EUR] (nezapomeňte si koupit regulátor KTX)		Smart Split třída I Cena bez DPH [EUR] (nezapomeňte si koupit SMARTWi-Fi regulátor VEO)		Kód produktu ... Kód konfigurace s. 366
		Barva	Chrom	Barvy RAL a speciální barvy	Chrom	Barvy RAL a speciální barvy	Chrom	Barvy RAL a speciální barvy	Chrom	Barvy RAL a speciální barvy	Chrom	Barvy RAL a speciální barvy	Chrom	Barvy RAL a speciální barvy	Chrom	Barvy RAL a speciální barvy	Chrom	Barvy RAL a speciální barvy	Chrom	
460	230	120	120	230	339	237	346	257	366	207	317	217	327	198	307	183	292	183	292	WLMIK046023...
710	230	200	120	246	394	253	402	273	421	223	372	233	382	214	362	199	348	199	348	WLMIK071023...
960	230	300	200	265	451	273	458	292	478	243	429	253	439	233	419	218	404	218	404	WLMIK096023...
1210	230	300	200	281	506	289	514	308	533	259	484	269	494	249	474	234	459	234	459	WLMIK121023...
1460	230	400	300	296	560	303	568	323	587	274	538	284	548	264	528	249	514	249	514	WLMIK146023...
1710	230	400	300	312	616	319	623	339	643	290	593	300	603	280	584	265	569	265	569	WLMIK171023...
435	430	200	120	275	394	282	402	302	421	253	372	263	382	243	362	228	348	228	348	WLMIK043043...
435	530	300	200	287	430	295	437	314	457	265	408	275	418	255	398	241	383	241	383	WLMIK043053...
735	430	400	200	298	502	306	510	325	530	276	480	286	490	266	471	252	456	252	456	WLMIK073043...
735	530	400	300	311	538	318	546	338	565	289	516	298	526	279	506	264	491	264	491	WLMIK073053...
1035	430	400	400	323	586	330	593	350	613	301	564	311	574	291	554	276	539	276	539	WLMIK103043...
1035	530	600	600	335	633	343	640	362	660	313	611	323	621	303	601	289	586	289	586	WLMIK103053...
1335	430	600	400	335	681	343	688	362	708	313	659	323	668	303	649	289	634	289	634	WLMIK133043...
1335	530	800	600	359	753	366	761	386	780	336	731	346	741	327	721	312	707	312	707	WLMIK133053...
1635	430	800	600	359	777	366	784	386	804	336	755	346	764	327	745	312	730	312	730	WLMIK163043...
1635	530	800	600	382	860	389	868	409	887	360	838	370	848	350	828	335	814	335	814	WLMIK163053...

Mike One



Barva je zahrnuta v ceně



výběr připojení v ceně



TŘÍDA I



45-60°C/2



P-W-U

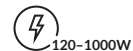

120-1000W



IR



IPx5



2h/1



Radiátor se zabudovanou topnou tyčí One. Funkce topné tyče ONE: Stránka 209.

DOPORUČUJEME PRO PŘIPOJENÍ S1 i S8:



Integrovaná sada termos-
tatická s ponornou trubicí,
Chrom

WRZT5G5-CR: 151EUR

WRZT5G6-CR: 151EUR

Stránka: 298



Sada krycí integrovaná,
Chrom

TGPCR002: 38EUR

Stránka: 338



Regulátor TTIR1

TGRTBI001: 104EUR

Stránka: 268

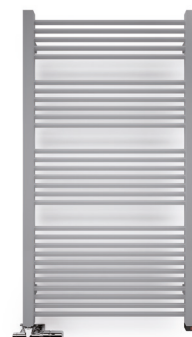

RADIÁTOR VODNĚ-ELEKTRICKÝ (CENA VČETNĚ ZABUDOVANÉ TOPNÉ TYČE ONE)

Připojení:

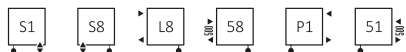

Vyber druh kabelu:

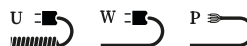

A ↕ [mm]	B ↔ [mm]	Barva ze vzorníku RAL a speciálních barev			Galvanický povrch Chrom			Barvy RAL a speciální barvy (Cena bez DPH [EUR])	Chrom (Cena bez DPH [EUR])	Kód produktu ... Kód konfigurace s.364
		75/65/20°C [W]	55/45/20°C [W]	[W]	75/65/20°C [W]	55/45/20°C [W]	[W]			
710	230	185	97	200	130	66	120	248	396	WZMIN071023...
735	430	337	176	400	236	120	200	301	505	WZMIN073043...
735	530	406	213	400	284	145	300	313	541	WZMIN073053...
960	230	247	130	300	173	88	200	266	453	WZMIN096023...
1035	430	466	245	400	326	167	300	325	589	WZMIN103043...
1035	530	563	295	600	394	201	400	338	635	WZMIN103053...
1210	230	308	162	300	216	110	200	284	509	WZMIN121023...
1335	430	593	312	600	415	212	400	338	683	WZMIN133043...
1335	530	715	376	800	501	255	600	361	756	WZMIN133053...
1460	230	367	193	400	257	131	300	298	563	WZMIN146023...
1635	430	716	377	800	501	256	600	361	779	WZMIN163043...
1635	530	864	454	800	605	308	600	384	863	WZMIN163053...
1710	230	425	224	400	298	152	300	314	618	WZMIN171023...

Mike One

RADIÁTOR ELEKTRICKÝ (CENA VČETNĚ NÁPLNĚ A ZABUDOVANÉ TOPNÉ TYČE ONE)





Připojení:

E1

E8

A ↕ [mm]	B ↔ [mm]	Výkon [W]		Barvy RAL a speciální barvy Cena bez DPH [EUR]	Chrom Cena bez DPH [EUR]	Kód produktu ... Kód konfigurace s. 365
		Barva	Chrom			
710	230	200	120	266	414	WWMIN071023...
735	430	400	200	319	523	WWMIN073043...
735	530	400	300	332	559	WWMIN073053...
960	230	300	200	285	472	WWMIN096023...
1035	430	400	300	344	607	WWMIN103043...
1035	530	600	400	356	654	WWMIN103053...
1210	230	300	200	302	527	WWMIN121023...
1335	430	600	400	356	702	WWMIN133043...
1335	530	800	400	380	774	WWMIN133053...
1460	230	400	600	317	581	WWMIN146023...
1635	430	800	600	380	798	WWMIN163043...
1635	530	800	600	403	881	WWMIN163053...
1710	230	400	300	333	637	WWMIN171023...

Nemo





 Barva je zahrnuta v ceně

 výběr připojení v ceně

DOPORUČUJEME PRO PŘIPOJENÍ VP, VL, V2 i V7:



Integrovaná sada uzavírací, Chrom

WRZOSSC1-CR: 116 EUR

Stránka: 299



Sada krycí integrovaná, Chrom

TGPCR002: 38 EUR

Stránka: 338

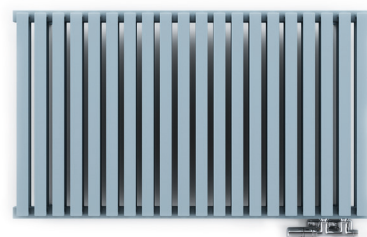

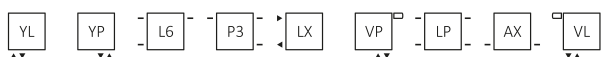

RADIÁTOR VODNÍ / VODNĚ-ELEKTRICKÝ (DOKOUPIT TOPNOU TYČ)

Připojení:

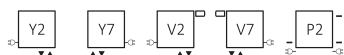

Šíře [mm] 645÷1725:



A ↑ [mm]	B ↔ [mm]	75/65/20°C [W]	55/45/20°C [W]	 [W]	Barvy RAL a speciální barvy Cena bez DPH [EUR]	Kód produktu ... Kód konfigurace s.363
300	645	375	199	400	243	WGNEM030064...
300	915	533	282	600	290	WGNEM030091...
300	1185	690	365	800	338	WGNEM030118...
300	1455	847	448	800	386	WGNEM030145...
300	1725	1004	532	1000	434	WGNEM030172...
530	375	364	190	–	225	WGNEM053037...
530	645	626	327	600	293	WGNEM053064...
530	915	888	464	800	362	WGNEM053091...
530	1185	1150	600	1200	432	WGNEM053118...
530	1455	1412	737	1500	501	WGNEM053145...
530	1725	1675	875	1500	570	WGNEM053172...





RADIÁTOR ELEKTRICKÝ (CENA VČETNĚ NÁPLNĚ A ZVOLENÉ TOPNÉ TYČE)

Připojení:



A ↕ [mm]	B ↔ [mm]	Výkon [W]	MEG Cena bez DPH [EUR]	MOA/DRY/ TDY Cena bez DPH [EUR] (MOA IR: + 12 EUR) (MOA BLUE: + 38 EUR)	ONE Cena bez DPH [EUR] (Nezabudovaná, v 8cm profilu v barvě radiátoru)	REG 2 Cena bez DPH [EUR]	REG 3 Cena bez DPH [EUR]	SIM Cena bez DPH [EUR]	Terma Split třída I Cena bez DPH [EUR] (nezapomeňte si koupit regulátor KTX)	Smart Split třída I Cena bez DPH [EUR] (nezapomeňte si koupit SMART Wi-Fi regulátor VEO)	Kód produktu ... Kód konfigurace s. 366
300	645	400	338	345	365	316	325	306	291	291	WLNEM030064...
300	915	600	384	392	412	362	372	352	338	338	WLNEM030091...
300	1185	800	432	440	459	410	420	400	386	386	WLNEM030118...
300	1455	800	480	488	507	458	468	448	434	434	WLNEM030145...
300	1725	1000	527	534	554	505	515	495	480	480	WLNEM030172...
530	375	–	–	–	–	–	–	–	–	–	WLNEM053037...
530	645	600	388	396	415	366	376	356	341	341	WLNEM053064...
530	915	800	457	464	484	435	445	425	410	410	WLNEM053091...
530	1185	1200	527	534	–	505	515	495	–	480	WLNEM053118...
530	1455	1500	–	–	–	–	–	564	–	549	WLNEM053145...
530	1725	1500	–	–	–	–	–	633	–	618	WLNEM053172...

Outcorner





 Barva je zahrnuta v ceně výběr připojení v ceně

DOPORUČUJEME PRO PŘIPOJENÍ SX:



Sada tříosová termostatická s možností montáže topné tyče skrz ventil, Chrom

  WRZTCG4-CR: 147 EUR

  WRZTCG5-CR: 147 EUR

Stránka: 295



Sada krycí dvojité, Chrom

TGPCR001: 27 EUR

Stránka: 337



RADIÁTOR VODNÍ / VODNĚ-ELEKTRICKÝ (DOKOUPIT TOPNOU TYČ)

Připojení:

Výška [mm] 465 ÷ 1545:

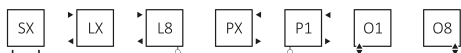

Výška [mm] 735 ÷ 1545:



A ↕ [mm]	B ↔ [mm]	75/65/20°C [W]	55/45/20°C [W]	 [W]	Barvy RAL a speciální barvy Cena bez DPH [EUR]	Kód produktu ... Kód konfigurace s. 363
465	300	294	160	300	271	WGQON046030...
735	300	421	228	400	301	WGQON073030...
1005	300	547	294	600	332	WGQON100030...
1275	300	673	361	800	361	WGQON127030...
1545	300	799	428	800	392	WGQON154030...

RADIÁTOR ELEKTRICKÝ (CENA VČETNĚ NÁPLNĚ A ZVOLENÉ TOPNÉ TYČE)

Připojení:



A ↕ [mm]	B ↔ [mm]	Výkon [W]	MEG Cena bez DPH [EUR]	MOA/DRY/TDY Cena bez DPH [EUR] (MOAIR: +12 EUR) (MOABLUE: +38 EUR)	ONE Cena bez DPH [EUR] (Nezabudovaná, v 8cm profilu v barvě radiátoru)	REG 2 Cena bez DPH [EUR]	REG 3 Cena bez DPH [EUR]	SIM Cena bez DPH [EUR]	Terma Split třída I Cena bez DPH [EUR] (nezapomeňte si koupit regulátor KTX)	Smart Split třída I Cena bez DPH [EUR] (nezapomeňte si koupit SMARTWi-Fi regulátor VEO)	Kód produktu ... Kód konfigurace s. 366
465	300	300	366	373	393	344	354	334	319	319	WLQON046030...
735	300	400	396	403	423	373	383	364	349	349	WLQON073030...
1005	300	600	426	434	453	404	414	394	380	380	WLQON100030...
1275	300	800	456	463	483	434	443	424	409	409	WLQON127030...
1545	300	800	487	494	514	464	474	455	440	440	WLQON154030...



výběr připojení
v ceně

SADA OBSAHUJE:



Sadu rohovou termostatickou
„Wood“, Měď kartáčovaná



2x Adaptér pro připojení
AL-PEX, závit 24 × 19



2x Adaptér na měď - Ø15



Dřevěné masivní věšáky



RADIÁTOR VODNÍ / VODNĚ-ELEKTRICKÝ (DOKOUPIT TOPNOU TYČ)

Připojení:

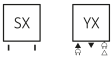

Radiátor je vyhotoven z měděných povrchově neupravených trubek a časem může chytat tmavší patinu.

A ↕ [mm]	B ↔ [mm]	75/65/20°C [W]	55/45/20°C [W]	[W]	Standardní barva RAW COPPER Cena bez DPH [EUR]	Kód produktu ... Kód konfigurace s. 363
1000	431	300	165	300	1 099	WGPAJ100043...
1000	531	339	184	400	1 153	WGPAJ100053...
1000	631	380	205	400	1 232	WGPAJ100063...
1400	431	368	199	400	1 139	WGPAJ140043...
1400	531	424	227	400	1 183	WGPAJ140053...
1400	631	480	256	600	1 274	WGPAJ140063...
1800	431	437	234	400	1 176	WGPAJ180043...
1800	531	510	272	600	1 226	WGPAJ180053...
1800	631	582	310	600	1 310	WGPAJ180063...

Pajak E



výběr připojení
v ceně

SADA OBSAHUJE:



Dřevěné masivní věšáky

RADIÁTOR ELEKTRICKÝ (CENA VČETNĚ NÁPLNĚ A ZVOLENÉ TOPNÉ TYČE)

Připojení:

 E1

 E8

Radiátor je vyhotoven z měděných povrchově neupravených trubek a časem může chytat tmavší patinu.

A ↕ [mm]	B ↔ [mm]	Výkon [W]	MEG Cena bez DPH [EUR]	MOA/DRY/ TDY Cena bez DPH [EUR] (MOAIR: +12 EUR) (MOABLUE: +38 EUR)	ONE Cena bez DPH [EUR] (Nezabudovaná, v 8cm profilu v barvě radiátoru)	REG 2 Cena bez DPH [EUR]	REG 3 Cena bez DPH [EUR]	SIM Cena bez DPH [EUR]	Terma Split třída I Cena bez DPH [EUR] (nezapomeňte si koupit regulátor KTX)	Smart Split třída I Cena bez DPH [EUR] (nezapomeňte si koupit SMART Wi-Fi regulátor VEO)	Kód produktu ... Kód konfigurace s. 366
923	431	300	1193	1200	1219	1171	1180	1160	1145	1145	WLPAJ092043...
923	531	400	1247	1254	1273	1225	1234	1214	1199	1199	WLPAJ092053...
923	631	400	1326	1333	1353	1304	1314	1294	1279	1279	WLPAJ092063...
1323	431	400	1233	1240	1260	1211	1220	1201	1186	1186	WLPAJ132043...
1323	531	400	1277	1284	1304	1255	1264	1245	1230	1230	WLPAJ132053...
1323	631	600	1368	1375	1394	1346	1355	1335	1320	1320	WLPAJ132063...
1723	431	400	1270	1277	1296	1248	1257	1237	1222	1222	WLPAJ172043...
1723	531	600	1320	1327	1347	1298	1308	1288	1273	1273	WLPAJ172053...
1723	631	600	1404	1411	1431	1382	1391	1371	1356	1356	WLPAJ172063...

Passo HX



Barva je zahrnuta v ceně



výběr připojení v ceně

DOPORUČUJEME PRO PŘIPOJENÍ SX:



Sada tříosová termostatická, Chrom

  WRZTCG1-CR: 143EUR

  WRZTCG2-CR: 143EUR

Stránka: 294



Sada krycí dvojitá, Chrom

TGPCR001: 27EUR

Stránka: 337

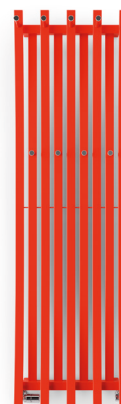

RADIÁTOR VODNÍ

Připojení:



A ↕ [mm]	B ↔ [mm]	75/65/20°C [W]	55/45/20°C [W]	Barvy RAL a speciální barvy Cena bez DPH [EUR]	Kód produktu ... Kód konfigurace s. 363
1800	520	889	457	835	WGPSW180052
1800	760	1275	638	935	WGPSW180076

Passo MH



Barva je zahrnuta v ceně



výběr připojení v ceně

DOPORUČUJEME PRO PŘIPOJENÍ SX:



Sada tříosová termostatická, Chrom

WRZTCG1-CR: 143EUR

WRZTCG2-CR: 143EUR

Stránka: 294



Sada krycí dvojitá, Chrom

TGPCR001: 27EUR

Stránka: 337



RADIÁTOR VODNÍ

Připojení:



A ↕ [mm]	B ↔ [mm]	75/65/20°C [W]	55/45/20°C [W]	Barvy RAL a speciální barvy Cena bez DPH [EUR]	Kód produktu ... Kód konfigurace s. 363
1800	520	766	391	825	WGPLW180052
1800	760	958	489	905	WGPLW180076

Perla



Barva je zahrnuta v ceně

výběr připojení v ceně

DOPORUČUJEME:



Sada krycí integrovaná, Chrom

TGPCR002: 38 EUR

Stránka: 338



Integrovaná sada uzavírací, Chrom

WRZOSSC1-CR: 116 EUR

Stránka: 299



RADIÁTOR VODNÍ:

Připojení:



A ↕ [mm]	B ↔ [mm]	Barva ze vzorníku RAL a speciálních barev		Galvanický povrch Chrom		Barvy RAL a speciální barvy Cena bez DPH [EUR]	Chrom Cena bez DPH [EUR]	Kód produktu ... Kód konfigurace s. 363
		75/65/20°C [W]	55/45/20°C [W]	75/65/20°C [W]	55/45/20°C [W]			
960	500	337	178	229	119	719	918	WGPER096050...
960	600	371	198	252	134	741	937	WGPER096060...
1360	500	478	253	325	168	822	1 000	WGPER136050...
1360	600	528	282	359	190	855	1 031	WGPER136060...
1760	500	630	334	419	218	887	1 078	WGPER176050...
1760	600	704	377	488	260	920	1 109	WGPER176060...

Perla E



Barva je zahrnuta v ceně



výběr připojení v ceně

RADIÁTOR ELEKTRICKÝ (CENA VČETNĚ VYHŘÍVÁNÍ TOPNÝM KABLEM)

Připojení:



Vyber druh kabelu:



A ↕ [mm]	B ↔ [mm]	Výkon [W]		Barvy RAL a speciální barvy Cena bez DPH [EUR]	Chrom Cena bez DPH [EUR]	Kód produktu ... Kód konfigurace s. 367
		Barva	Chrom			
1360	500	284	213	842	1045	WSPER136050...
1760	600	455	284	933	1152	WSPER176060...

* Radiátor s topným kabelem v celém těle. Druh kabelu zvolte W, P nebo U. Viz Legenda Druhů kabelů. Stránka 206

Pier



Barva je zahrnuta v ceně



výběr připojení v ceně

DOPORUČUJEME PRO PŘIPOJENÍ SX:



Sada tříosová termostatická, Chrom

  WRZTCG1-CR: 143EUR

  WRZTCG2-CR: 143EUR

Stránka: 294



Sada krycí dvojitá, Chrom

TGPCR001: 27EUR

Stránka: 337

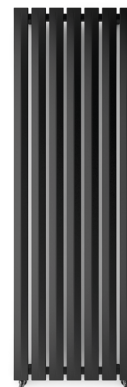

RADIÁTOR VODNÍ:

Připojení:



A ⇕ [mm]	B ⇔ [mm]	75/65/20°C [W]	55/45/20°C [W]	Barvy RAL a speciální barvy Cena bez DPH [EUR]	Kód produktu ... Kód konfigurace s. 363
1380	410	564	303	420	WGB19138041...
1680	410	687	360	450	WGB19168041...
1800	580	1025	532	566	WGB19180058...

PLC V



Barva je zahrnuta v ceně



výběr připojení v ceně

DOPORUČUJEME:



Integrovaná sada termostatická, Chrom

 WRZT5G1-CR: 145 EUR

 WRZT5G2-CR: 145 EUR

Stránka: 296



Sada krycí integrovaná, Chrom

TGPCR002: 38 EUR

Stránka: 338



RADIÁTOR VODNÍ:

Připojení:

Šíře [mm] 263

Šíře [mm] 463 ÷ 663:



A ⇕ [mm]	B ⇔ [mm]	75/65/20°C [W]	55/45/20°C [W]	Barvy RAL a speciální barvy Cena bez DPH [EUR]	Kód produktu ... Kód konfigurace s. 363
1580	263	331	169	1 638	WGPLV158026...
1600	463	613	312	2 102	WGPLV160046...
1600	663	894	456	2 617	WGPLV160066...
1780	263	373	190	1 715	WGPLV178026...
1800	463	690	352	2 230	WGPLV180046...
1800	663	1007	514	2 745	WGPLV180066...

PLC H



Barva je zahrnuta v ceně



výběr připojení v ceně

DOPORUČUJEME:



Sada rohová termostatická, Chrom

WRZTCG3-CR: 134 EUR

Stránka: 292



Sada krycí dvojitá, Chrom

TGPCR001: 27 EUR

Stránka: 337

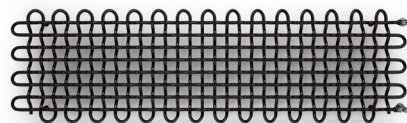

RADIÁTOR VODNÍ:

Připojení:



A ↕ [mm]	B ↔ [mm]	75/65/20°C [W]	55/45/20°C [W]	Barvy RAL a speciální barvy Cena bez DPH [EUR]	Kód produktu ... Kód konfigurace s.363
263	1600	341	174	2 145	WGPLH026160...
463	1600	622	317	2 461	WGPLH046160...

POC 2



DOPORUČUJEME PRO PŘIPOJENÍ SX:



Sada tříosová termostatická,
Chrom

WRZTCG1-CR: 143EUR

WRZTCG2-CR: 143EUR

Stránka: 294



Sada krycí dvojité, Chrom

TGPCR001: 27EUR

Stránka: 337



Háček bodový YO!

WRWYOY001*: 4EUR

Stránka: 280



Topná tyč MOA IR, Chrom

WEMOR*: 117EUR

Stránka: 258

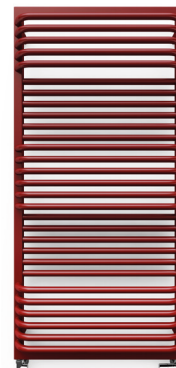

RADIÁTOR VODNÍ / VODNĚ-ELEKTRICKÝ (DOKOUPIT TOPNOU TYČ)

Připojení:

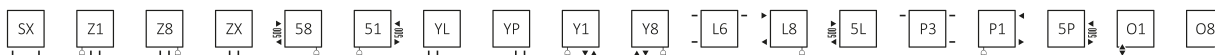

A ↕ [mm]	B ↔ [mm]	75/65/20°C [W]	55/45/20°C [W]	 [W]	Barvy RAL a speciální barvy Cena bez DPH [EUR]	Kód produktu ... Kód konfigurace s. 363
600	450	308	167	300	220	WGZUL060045...
600	500	342	185	400	225	WGZUL060050...
600	600	410	222	400	234	WGZUL060060...
840	450	443	239	400	248	WGZUL084045...
840	500	493	266	600	258	WGZUL084050...
840	600	590	318	600	266	WGZUL084060...
840	700	690	372	800	281	WGZUL084070...
1040	450	556	299	600	269	WGZUL104045...
1040	500	618	332	600	276	WGZUL104050...
1040	600	743	399	800	286	WGZUL104060...
1040	700	866	465	800	295	WGZUL104070...
1240	450	669	359	800	290	WGZUL124045...
1240	500	744	399	800	300	WGZUL124050...
1240	600	893	479	1000	313	WGZUL124060...
1240	700	1041	559	1000	328	WGZUL124070...
1400	500	844	452	800	346	WGZUL140050...
1400	600	1013	543	1000	365	WGZUL140060...
1400	700	1182	633	1200	388	WGZUL140070...

POC 2

RADIÁTOR ELEKTRICKÝ (CENA VČETNĚ NÁPLNĚ A ZVOLENÉ TOPNÉ TYČE)

Připojení:



A ↕ [mm]	B ↔ [mm]	Výkon [W]	MEG Cena bez DPH [EUR]	MOA/DRY/TDY Cena bez DPH [EUR] (MOA IR: + 12 EUR) (MOA BLUE: + 38 EUR)	ONE Cena bez DPH [EUR] (Nezabudovaná, v 8cm profilu v barvě radiátoru)	REG 2 Cena bez DPH [EUR]	REG 3 Cena bez DPH [EUR]	SIM Cena bez DPH [EUR]	Terma Split třída I Cena bez DPH [EUR] (nezapomeňte si koupit regulátor KTX)	Smart Split třída I Cena bez DPH [EUR] (nezapomeňte si koupit SMART Wi-Fi regulátor VEO)	Kód produktu ... Kód konfigurace s. 366
600	450	300	314	322	341	292	302	282	268	268	WLZUL060045...
600	500	400	319	327	346	297	307	287	273	273	WLZUL060050...
600	600	400	329	336	356	307	317	297	282	282	WLZUL060060...
840	450	400	343	350	370	321	330	311	296	296	WLZUL084045...
840	500	600	352	360	380	330	340	321	306	306	WLZUL084050...
840	600	600	361	368	388	339	349	329	314	314	WLZUL084060...
840	700	800	376	383	403	354	364	344	329	329	WLZUL084070...
1040	450	600	364	371	391	341	351	332	317	317	WLZUL104045...
1040	500	600	371	378	398	349	359	339	324	324	WLZUL104050...
1040	600	800	381	388	408	359	368	349	334	334	WLZUL104060...
1040	700	800	389	397	416	367	377	357	343	343	WLZUL104070...
1240	450	800	384	392	412	362	372	352	338	338	WLZUL124045...
1240	500	800	394	402	421	372	382	362	348	348	WLZUL124050...
1240	600	1000	408	415	435	386	396	376	361	361	WLZUL124060...
1240	700	1000	423	430	450	400	410	391	376	376	WLZUL124070...
1400	500	800	441	448	468	419	429	409	394	394	WLZUL140050...
1400	600	1000	459	467	487	437	447	427	413	413	WLZUL140060...
1400	700	1200	483	490	510	461	471	451	436	436	WLZUL140070...

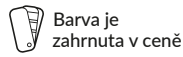

Barva je zahrnuta v ceně

výběr připojení v ceně

DOPORUČUJEME PRO PŘIPOJENÍ SX:



Sada tříosová termostatická, Chrom

WRZTCG1-CR: 143EUR

WRZTCG2-CR: 143EUR

Stránka: 294



Sada krycí dvojitá, Chrom

TGPCR001: 27EUR

Stránka: 337



Háček bodový YO!

WRWYOY001*: 4EUR

Stránka: 280



RADIÁTOR VODNÍ / VODNĚ-ELEKTRICKÝ (DOKOUPIT TOPNOU TYČ)

Připojení:



A ↓ [mm]	B ↔ [mm]	Barva ze vzorníku RAL a speciálních barev			Galvanický povrch Chrom			Barvy RAL a speciální barvy Cena bez DPH [EUR]	Chrom Cena bez DPH [EUR]	Kód produktu ... Kód konfigurace s. 363
		75/65/20°C [W]	55/45/20°C [W]	 [W]	75/65/20°C [W]	55/45/20°C [W]	 [W]			
780	500	392	211	400	274	140	300	202	522	WGPAL078050...
780	600	471	254	400	330	168	300	212	569	WGPAL078060...
1180	500	638	342	600	447	228	400	250	646	WGPAL118050...
1180	600	766	411	800	536	273	600	268	692	WGPAL118060...
1580	500	883	473	800	618	315	600	287	892	WGPAL158050...
1580	600	1061	568	1000	743	379	800	324	954	WGPAL158060...

RADIÁTOR ELEKTRICKÝ (CENA VČETNĚ NÁPLNĚ A ZVOLENÉ TOPNÉ TYČE)

Připojení:



A ↓ [mm]	B ↔ [mm]	Výkon [W]		MEG Cena bez DPH [EUR]		MOA/DRY/TDY Cena bez DPH [EUR] (MOAIR: + 12 EUR) (MOABLUE: + 38 EUR)		ONE Cena bez DPH [EUR] (Nezabudovaná, v 8cm profilu v barvě radiátoru)		REG 2 Cena bez DPH [EUR]		REG 3 Cena bez DPH [EUR]		SIM Cena bez DPH [EUR]		Terma Split třída I Cena bez DPH [EUR] (nezapomeňte si koupit regulátor KTX)		Smart Split třída I Cena bez DPH [EUR] (nezapomeňte si koupit SMART Wi-Fi regulátor VEO)		Kód produktu ... Kód konfigurace s. 366
		Barva	Chrom	Barvy RAL a speciální barvy	Chrom	Barvy RAL a speciální barvy	Chrom	Barvy RAL a speciální barvy	Chrom	Barvy RAL a speciální barvy	Chrom	Barvy RAL a speciální barvy	Chrom	Barvy RAL a speciální barvy	Chrom	Barvy RAL a speciální barvy	Chrom			
780	500	400	300	297	617	305	624	324	644	275	595	285	605	265	585	250	570	250	570	WLPAL078050...
780	600	400	300	307	664	314	671	334	691	285	641	295	651	275	632	260	617	260	617	WLPAL078060...
1180	500	600	400	345	741	352	748	372	768	323	719	333	729	313	709	298	694	298	694	WLPAL118050...
1180	600	800	600	362	787	370	794	389	814	340	764	350	774	330	755	316	740	316	740	WLPAL118060...
1580	500	800	600	382	987	389	994	409	1014	360	965	370	975	350	955	335	940	335	940	WLPAL158050...
1580	600	1000	800	418	1048	425	1056	445	1075	396	1026	405	1036	386	1016	371	1002	371	1002	WLPAL158060...

Pola One

Barva je zahrnuta v ceně výběr připojení v ceně

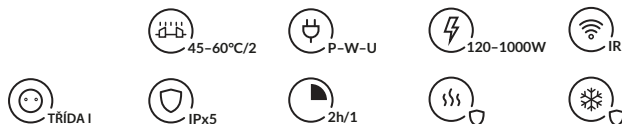

DOPORUČUJEME PRO PŘIPOJENÍ S1 i S8:



Integrovaná sada termostatická s ponornou trubicí, Chrom

WRZT5G5-CR: 151EUR

WRZT5G6-CR: 151EUR

Stránka: 298



Sada krycí integrovaná, Chrom

TGPCR002: 38EUR

Stránka: 338



Háček bodový YO!

WRWYOY001*: 4EUR

Stránka: 280



RADIÁTOR VODNĚ-ELEKTRICKÝ (CENA VČETNĚ ZABUDOVANÉ TOPNÉ TYČE ONE)

Připojení:

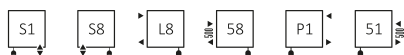

Vyber druh kabelu:

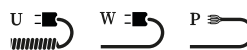

A ↓ [mm]	B ↔ [mm]	Barva ze vzorníku RAL a speciálních barev			Galvanický povrch Chrom			Barvy RAL a speciální barvy Cena bez DPH [EUR]	Chrom Cena bez DPH [EUR]	Kód produktu ... Kód konfigurace s. 364
		75/65/20°C [W]	55/45/20°C [W]	[W]	75/65/20°C [W]	55/45/20°C [W]	[W]			
780	500	392	211	400	274	140	300	300	619	WZPAN078050...
780	600	471	254	400	330	168	300	309	666	WZPAN078060...
1180	500	638	342	600	447	228	400	348	743	WZPAN118050...
1180	600	766	411	800	536	273	600	365	789	WZPAN118060...
1580	500	883	473	800	618	315	600	384	989	WZPAN158050...
1580	600	1061	568	1000	743	379	800	420	1051	WZPAN158060...

RADIÁTOR ELEKTRICKÝ (CENA VČETNĚ NÁPLNĚ A ZABUDOVANÉ TOPNÉ TYČE ONE)

Připojení:

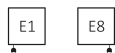



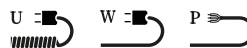

Vyber druh kabelu:



A ↓ [mm]	B ↔ [mm]	Výkon [W]		Barvy RAL a speciální barvy Cena bez DPH [EUR]	Chrom Cena bez DPH [EUR]	Kód produktu ... Kód konfigurace s. 365
		Barva	Chrom			
780	500	400	300	318	638	WWPAN078050...
780	600	400	300	328	684	WWPAN078060...
1180	500	600	400	366	762	WWPAN118050...
1180	600	800	600	383	807	WWPAN118060...
1580	500	800	600	403	1008	WWPAN158050...
1580	600	1000	800	439	1069	WWPAN158060...

Quadrus Bold





 Barva je zahrnuta v ceně

 výběr připojení v ceně

DOPORUČUJEME PRO PŘIPOJENÍ: Z1, Z8 i ZX:



Integrovaná sada termostatická, Chrom

 WRZT5G1-CR: 145 EUR

 WRZT5G2-CR: 145 EUR

Stránka: 296



Sada krycí integrovaná, Chrom

TGPCR002: 38 EUR

Stránka: 338



RADIÁTOR VODNÍ / VODNĚ-ELEKTRICKÝ (DOKOUPIT TOPNOU TYČ)

Připojení:

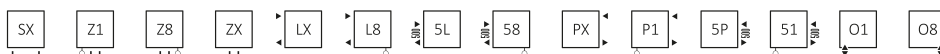

A ↕ [mm]	B ↔ [mm]	75/65/20°C [W]	55/45/20°C [W]	 [W]	Barvy RAL a speciální barvy Cena bez DPH [EUR]	Kód produktu ... Kód konfigurace s. 363
870	450	531	285	600	391	WGQBA087045...
870	600	708	380	800	424	WGQBA087060...
1185	450	835	446	800	441	WGQBA118045...
1185	600	1113	594	1000	490	WGQBA118060...

RADIÁTOR ELEKTRICKÝ (CENA VČETNĚ NÁPLNĚ A ZVOLENÉ TOPNÉ TYČE)

Připojení:



A ↕ [mm]	B ↔ [mm]	Výkon [W]	MEG Cena bez DPH [EUR]	MOA/DRY/ TDY Cena bez DPH [EUR] (MOA IR: +12 EUR) (MOA BLUE: +38 EUR)	ONE Cena bez DPH [EUR] (Nezabudovaná, v 8cm profilu v barvě radiátoru)	REG 2 Cena bez DPH [EUR]	REG 3 Cena bez DPH [EUR]	SIM Cena bez DPH [EUR]	Terma Split třída I Cena bez DPH [EUR] (nezapomeňte si koupit regulátor KTX)	Smart Split třída I Cena bez DPH [EUR] (nezapomeňte si koupit SMART Wi-Fi regulátor VEO)	Kód produktu ... Kód konfigurace s. 366
870	450	600	485	493	512	463	473	453	439	439	WLQBA087045...
870	600	800	518	526	546	496	506	487	472	472	WLQBA087060...
1185	450	800	534	542	562	512	522	502	488	488	WLQBA118045...
1185	600	1000	585	592	612	563	573	553	538	538	WLQBA118060...

Quadrus Bold One



Barva je zahrnuta v ceně



výběr připojení v ceně



45–60°C/2



P-W-U

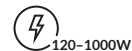

120–1000W



IR



TŘÍDA I



IPx5



2h/1



SADA OBSAHUJE:

Radiátor se zabudovanou topnou tyčičí One. Funkce topné tyče ONE: Stránka 209.

DOPORUČUJEME PRO PŘIPOJENÍ S1 i S8:



Integrovaná sada termostatická s ponornou trubčicí, Chrom

WRZT5G5-CR: 151 EUR

WRZT5G6-CR: 151 EUR

Stránka: 298



Sada krycí integrovaná, Chrom

TGPCR002: 38 EUR

Stránka: 338



RADIÁTOR VODNĚ-ELEKTRICKÝ (CENA VČETNĚ ZABUDOVANÉ TOPNÉ TYČE ONE)

Připojení:

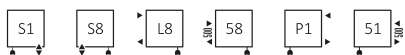

Vyber druh kabelu:

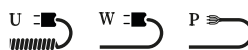

A ↕ [mm]	B ↔ [mm]	75/65/20°C [W]	55/45/20°C [W]	[W]	Barvy RAL a speciální barvy Cena bez DPH [EUR]	Kód produktu ... Kód konfigurace s.364
870	450	531	285	600	488	WZQBN087045...
870	600	708	380	800	521	WZQBN087060...
1185	450	835	446	800	537	WZQBN118045...
1185	600	1113	594	1000	587	WZQBN118060...

RADIÁTOR ELEKTRICKÝ (CENA VČETNĚ NÁPLNĚ A ZABUDOVANÉ TOPNÉ TYČE ONE)

Připojení:



Vyber druh kabelu:



A ↕ [mm]	B ↔ [mm]	Výkon [W]	Barvy RAL a speciální barvy Cena bez DPH [EUR]	Kód produktu ... Kód konfigurace s.365
870	450	600	506	WWQBN087045...
870	600	800	539	WWQBN087060...
1185	450	800	555	WWQBN118045...
1185	600	1000	606	WWQBN118060...

Quadrus Slim



Barva je zahrnuta v ceně

výběr připojení v ceně

DOPORUČUJEME PRO PŘIPOJENÍ Z1, Z8 i ZX:



Integrovaná sada termostatická,

Chrom

WRZT5G1-CR: 145 EUR

WRZT5G2-CR: 145 EUR

Stránka: 296



Sada krycí integrovaná, Chrom

TGPCR002: 38 EUR

Stránka: 338



Topná tyč REG 2, Černá

WER2G01*: 76 EUR

Stránka: 264



RADIÁTOR VODNÍ / VODNĚ-ELEKTRICKÝ (DOKOUPIT TOPNOU TYČ)

Připojení:

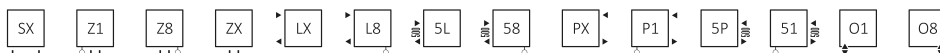

A ↕ [mm]	B ↔ [mm]	75/65/20°C [W]	55/45/20°C [W]	 [W]	Barvy RAL a speciální barvy Cena bez DPH [EUR]	Kód produktu ... Kód konfigurace s. 363
870	450	409	217	400	311	WGQUS087045...
870	600	559	296	600	327	WGQUS087060...
1185	450	537	278	600	344	WGQUS118045...
1185	600	733	379	800	377	WGQUS118060...

RADIÁTOR ELEKTRICKÝ (CENA VČETNĚ NÁPLNĚ A ZVOLENÉ TOPNÉ TYČE)

Připojení:

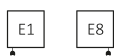

A ↕ [mm]	B ↔ [mm]	Výkon [W]	MEG Cena bez DPH [EUR]	MOA/DRY/ TDY Cena bez DPH [EUR] (MOAIR: +12 EUR) (MOA BLUE: +38 EUR)	ONE Cena bez DPH [EUR] (Nezabudovaná, v 8cm profilu v barvě radiátoru)	REG 2 Cena bez DPH [EUR]	REG 3 Cena bez DPH [EUR]	SIM Cena bez DPH [EUR]	Terma Split třída I Cena bez DPH [EUR] (nezapomeňte si koupit regulátor KTX)	Smart Split třída I Cena bez DPH [EUR] (nezapomeňte si koupit SMART Wi-Fi regulátor VEO)	Kód produktu ... Kód konfigurace s. 366
870	450	400	405	413	432	383	393	373	359	359	WLQUS087045...
870	600	600	421	429	448	399	409	389	375	375	WLQUS087060...
1185	450	600	439	446	466	416	426	407	392	392	WLQUS118045...
1185	600	800	472	479	499	450	459	440	425	425	WLQUS118060...

Quadrus Slim One



Barva je zahrnuta v ceně

výběr připojení v ceně



45-60°C/2



P-W-U

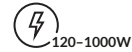

120-1000W



IR



TŘÍDA I



IPx5



2h/1



SADA OBSAHUJE:

Radiátor se zabudovanou topnou tyčicí One. Funkce topné tyče ONE: Stránka 209.

DOPORUČUJEME PRO PŘIPOJENÍ S1 i S8:



Integrovaná sada termostatická s ponomou trubící, Chrom

 WRZT5G5-CR: 151EUR

 WRZT5G6-CR: 151EUR

Stránka: 298



Sada krycí integrovaná, Chrom

TGPCR002: 38EUR

Stránka: 338



Regulátor TTIR1

TGRTBI001: 104EUR

Stránka: 268



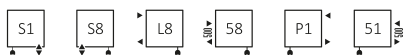

RADIÁTOR VODNĚ-ELEKTRICKÝ (CENA VČETNĚ ZABUDOVANÉ TOPNÉ TYČE ONE)

Připojení:

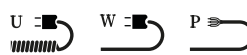

Vyber druh kabelu:



A ↕ [mm]	B ↔ [mm]	75/65/20°C [W]	55/45/20°C [W]	 [W]	Barvy RAL a speciální barvy Cena bez DPH [EUR]	Kód produktu ... Kód konfigurace s.364
870	450	409	217	400	408	WZQSN087045...
870	600	559	296	600	424	WZQSN087060...
1185	450	537	278	600	441	WZQSN118045...
1185	600	733	379	800	474	WZQSN118060...

RADIÁTOR ELEKTRICKÝ (CENA VČETNĚ NÁPLNĚ A ZABUDOVANÉ TOPNÉ TYČE ONE)

Připojení:



Vyber druh kabelu:

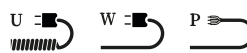

A ↕ [mm]	B ↔ [mm]	Výkon [W]	Barvy RAL a speciální barvy Cena bez DPH [EUR]	Kód produktu ... Kód konfigurace s.365
870	450	400	426	WWQSN087045...
870	600	600	442	WWQSN087060...
1185	450	600	459	WWQSN118045...
1185	600	800	493	WWQSN118060...

Retro



Barva je zahrnuta v ceně

výběr připojení v ceně

DOPORUČUJEME:



Sada krycí dvojité, Chrom

TGPCR001: 27 EUR

Stránka: 337



Sada regulační rohová Star, Chrom

TGERSTCR01: 148 EUR

Stránka: 291

Vhodné jsou také ventily MINIMALIST.

Stránka: 308



RADIÁTOR VODNÍ / VODNĚ-ELEKTRICKÝ (DOKOUPIT TOPNOU TYČ)

Připojení:



B ↔ [mm]	B ↔ [mm]	Barva ze vzorníku RAL a speciálních barev			Galvanický povrch Chrom			Barvy RAL a speciální barvy Cena bez DPH [EUR]	Chrom Cena bez DPH [EUR]	Kód produktu ... Kód konfigurace s. 363
		75/65/20°C [W]	55/45/20°C [W]	[W]	75/65/20°C [W]	55/45/20°C [W]	[W]			
430	504	115	63	120	81	44	120	319	426	WGRE1043050...
800	504	210	114	200	147	80	120	377	561	WGRE1080050...
1170	504	308	165	300	216	116	200	441	695	WGRE1117050...
1540	504	405	216	400	284	151	300	500	854	WGRE1154050...

RADIÁTOR ELEKTRICKÝ (CENA VČETNĚ NÁPLNĚ A ZVOLENÉ TOPNÉ TYČE)

Připojení:



A ↕ [mm]	B ↔ [mm]	Výkon [W]		MEG Cena bez DPH [EUR]		MOA/DRY/TDY Cena bez DPH [EUR] (MOAIR: +12 EUR) (MOABLUE: +38 EUR)		ONE Cena bez DPH [EUR] (Nezabudovaná, v 8cm profilu v barvě radiátoru)		REG 2 Cena bez DPH [EUR]		REG 3 Cena bez DPH [EUR]		SIM Cena bez DPH [EUR]		Terma Split třída I Cena bez DPH [EUR] (nezapomeňte si koupit regulátor KTX)		Smart Split třída I Cena bez DPH [EUR] (nezapomeňte si koupit SMARTWi-Fi regulátor VEO)		Kód produktu ... Kód konfigurace s. 366
		Barva	Chrom	Barvy RAL a speciální barvy	Chrom	Barvy RAL a speciální barvy	Chrom	Barvy RAL a speciální barvy	Chrom	Barvy RAL a speciální barvy	Chrom	Barvy RAL a speciální barvy	Chrom	Barvy RAL a speciální barvy	Chrom	Barvy RAL a speciální barvy	Chrom			
430	504	120	120	403	515	410	522	430	542	381	493	391	502	371	483	356	468	356	468	WLRE1043050...
800	504	200	120	463	657	471	665	490	684	441	635	451	645	431	625	416	611	416	611	WLRE1080050...
1170	504	300	200	530	799	537	806	557	826	507	777	517	787	498	767	483	752	483	752	WLRE1117050...
1540	504	400	300	592	964	600	971	619	991	570	941	580	951	560	932	546	917	546	917	WLRE1154050...

Retro S



Barva je zahrnuta v ceně

výběr připojení v ceně

DOPORUČUJEME:



Sada krycí dvojité, Chrom

TGPCR001: 27 EUR

Stránka: 337



Sada regulační rohová Star, Chrom

TGERSTCR01: 148 EUR

Stránka: 291

Vhodné jsou také ventily MINIMALIST.

Stránka: 308



RADIÁTOR VODNÍ

Připojení:

- AX -

A ⇄ [mm]	B ⇄ [mm]	Barva ze vzorníku RAL a speciálních barev		Galvanický povrch Chrom		Barvy RAL a speciální barvy Cena bez DPH [EUR]	Chrom Cena bez DPH [EUR]	Kód produktu ... Kód konfigurace s. 363
		75/65/20°C [W]	55/45/20°C [W]	75/65/20°C [W]	55/45/20°C [W]			
875	504	200	109	140	71	404	570	WGR1S087050...
1060	504	240	131	168	86	431	645	WGR1S106050...
1245	504	283	153	198	101	464	725	WGR1S124050...
1430	504	325	175	228	116	492	795	WGR1S143050...

Ribbon V



Barva je zahrnuta v ceně



výběr připojení v ceně

DOPORUČUJEME:



Integrovaná sada termostatická, Chrom

WRZT5G1-CR: 145 EUR

WRZT5G2-CR: 145 EUR

Stránka: 296



Sada krycí integrovaná, Chrom

TGPCR002: 38 EUR

Stránka: 338



Čistící kartáč Ribbon

TGI009: 19 EUR

Stránka 285

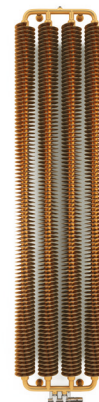

RADIÁTOR VODNÍ

Připojení:



A ↕ [mm]	B ↔ [mm]	75/65/20°C [W]	55/45/20°C [W]	Barvy RAL a speciální barvy Cena bez DPH [EUR]	Kód produktu ... Kód konfigurace s. 363
1720	290	660	330	869	WGRIB172029...
1720	390	872	436	1 002	WGRIB172039...
1920	390	989	499	1 056	WGRIB192039...
1920	490	1240	626	1 269	WGRIB192049...

Ribbon V E



Barva je zahrnutá v ceně



výběr připojení v ceně

DOPORUČUJEME:



Čistící kartáč Ribbon

TGI009: 19 EUR

Stránka: 339

RADIÁTOR ELEKTRICKÝ (CENA VČETNĚ NÁPLNĚ A ZVOLENÉ TOPNÉ TYČE)

Připojení:

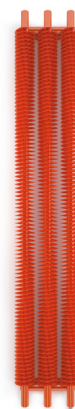

A ⇅ [mm]	B ↔ [mm]	Výkon [W]	MEG Cena bez DPH [EUR]	MOA/DRY/ TDY Cena bez DPH [EUR] (MOAIR: +12 EUR) (MOA BLUE: +38 EUR)	ONE Cena bez DPH [EUR] (Nezabudovaná, v 8cm profilu v barvě radiátoru)	REG 2 Cena bez DPH [EUR]	REG 3 Cena bez DPH [EUR]	SIM Cena bez DPH [EUR]	Terma Split třída I Cena bez DPH [EUR] (nezapomeňte si koupit regulátor KTX)	Smart Split třída I Cena bez DPH [EUR] (nezapomeňte si koupit SMART Wi-Fi regulátor VEO)	Kód produktu ... Kód konfigurace s. 366
1800	290	600	709	716	736	687	697	677	662	662	WLRVE180029...
1800	390	800	878	885	905	855	865	846	831	831	WLRVE180039...
1800	490	1000	1016	1024	1044	994	1004	984	970	970	WLRVE180049...

Ribbon HSD



Barva je zahrnuta v ceně



výběr připojení v ceně

DOPORUČUJEME PRO PŘIPOJENÍ YL i YP:



Sada krycí integrovaná, Chrom

TGPCR002: 38 EUR

Stránka: 338



Integrovaná sada termostatická, Chrom

WRZT5G3-CR: 146 EUR

WRZT5G4-CR: 146 EUR

Stránka: 296

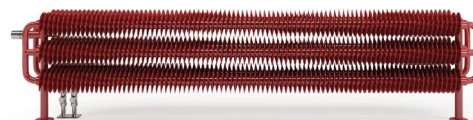

Čistící kartáč Ribbon

TGI009: 19 EUR

Stránka: 339

RADIÁTOR VODNÍ

Připojení:



A ↕ [mm]	B ↔ [mm]	75/65/20°C [W]	55/45/20°C [W]	Barvy RAL a speciální barvy Cena bez DPH [EUR]	Kód produktu ... Kód konfigurace s. 363
190	1540	1207	683	1 154	WGHSD019154...
190	1740	1364	772	1 272	WGHSD019174...
190	1940	1420	803	1 549	WGHSD019194...
290	1540	1609	909	1 627	WGHSD029154...
290	1740	1818	1028	1 746	WGHSD029174...
290	1940	2027	1146	1 944	WGHSD029194...

Ribbon HWS



Barva je zahrnuta v ceně



výběr připojení v ceně

DOPORUČUJEME PRO PŘIPOJENÍ VP i VL:



Sada krycí integrovaná, Chrom

TGPCR002: 38 EUR

Stránka: 338



Integrovaná sada uzavírací, Chrom

WRZOSSC1-CR: 116 EUR

Stránka: 299



Čistící kartáč Ribbon

TGI009: 19 EUR

Stránka: 339

RADIÁTOR VODNÍ

Připojení:



A ↕ [mm]	B ↔ [mm]	75/65/20°C [W]	55/45/20°C [W]	Barvy RAL a speciální barvy Cena bez DPH [EUR]	Kód produktu ... Kód konfigurace s. 363
290	1540	802	411	903	WGHWS029154...
290	1740	906	464	940	WGHWS029174...
290	1940	1010	517	1 053	WGHWS029194...
390	1540	990	504	1 090	WGHWS039154...
390	1740	1119	570	1 165	WGHWS039174...
390	1940	1248	636	1 315	WGHWS039194...
490	1540	1329	670	1 352	WGHWS049154...
490	1740	1501	757	1 464	WGHWS049174...
490	1940	1673	844	1 614	WGHWS049194...

Rolo Hanger



Barva je zahrnuta v ceně

výběr připojení v ceně

DOPORUČUJEME PRO PŘIPOJENÍ SX:



Sada tříosová termostatická, Chrom

WRZTCG1-CR: 143EUR

WRZTCG2-CR: 143EUR

Stránka: 294



Sada krycí dvojitá, Chrom

TGPCR001: 27EUR

Stránka: 337



RADIÁTOR VODNÍ / VODNĚ-ELEKTRICKÝ (DOKOUPIT TOPNOU TYČ)

Připojení:



A \updownarrow [mm]	B \leftrightarrow [mm]	75/65/20°C [W]	55/45/20°C [W]	Barvy RAL a speciální barvy Cena bez DPH [EUR]	Kód produktu ... Kód konfigurace s. 363
1200	95	162	82	190	WGROW120009...
1200	105	242	122	224	WGROW120015...
1200	205	323	163	258	WGROW120020...
1200	260	404	204	278	WGROW120026...
1200	370	565	285	363	WGROW120037...
1200	480	726	366	427	WGROW120048...
1200	590	888	447	486	WGROW120059...
1800	95	237	118	222	WGROW180009...
1800	105	356	177	264	WGROW180015...
1800	205	474	235	306	WGROW180020...
1800	260	573	284	339	WGROW180026...
1800	370	802	398	444	WGROW180037...
1800	480	1031	512	528	WGROW180048...
1800	590	1260	625	599	WGROW180059...

Rolo Hanger

RADIÁTOR ELEKTRICKÝ (CENA VČETNĚ NÁPLNĚ A ZVOLENÉ TOPNÉ TYČE)

Připojení:



A ↕ [mm]	B ↔ [mm]	Výkon [W]	MEG Cena bez DPH [EUR]	MOA/DRY/ TDY Cena bez DPH [EUR] (MOAIR: +12 EUR) (MOA BLUE: +38 EUR)	ONE Cena bez DPH [EUR] (Nezabudovaná, v 8cm profilu v barvě radiátoru)	REG 2 Cena bez DPH [EUR]	REG 3 Cena bez DPH [EUR]	SIM Cena bez DPH [EUR]	Terma Split třída I Cena bez DPH [EUR] (nezapomeňte si koupit regulátor KTX)	Smart Split třída I Cena bez DPH [EUR] (nezapomeňte si koupit SMART Wi-Fi regulátor VEO)	Kód produktu ... Kód konfigurace s. 366
1200	95	200	285	292	312	263	273	253	238	238	WLROW120009...
1200	105	300	319	326	346	297	307	287	272	272	WLROW120015...
1200	205	300	353	360	380	331	341	321	306	306	WLROW120020...
1200	260	400	373	380	400	351	361	341	326	326	WLROW120026...
1200	370	600	458	465	485	436	446	426	411	411	WLROW120037...
1200	480	800	522	529	549	500	510	490	475	475	WLROW120048...
1200	590	800	581	588	608	559	569	549	534	534	WLROW120059...
1800	95	300	317	324	344	295	305	285	270	270	WLROW180009...
1800	105	400	359	366	386	337	347	327	312	312	WLROW180015...
1800	205	600	401	408	428	379	389	369	354	354	WLROW180020...
1800	260	600	434	441	461	412	422	402	387	387	WLROW180026...
1800	370	800	539	546	566	517	527	507	492	492	WLROW180037...
1800	480	1000	623	630	650	601	611	591	576	576	WLROW180048...
1800	590	1200	694	701	721	672	682	662	647	647	WLROW180059...

Rolo Room



Barva je zahrnuta v ceně

výběr připojení v ceně

DOPORUČUJEME PRO PŘIPOJENÍ SX:



Sada tříosová termostatická, Chrom

WRZTCG1-CR: 143EUR

WRZTCG2-CR: 143EUR

Stránka: 294



Sada krycí dvojitá, Chrom

TGPCR001: 27EUR

Stránka: 337

RADIÁTOR VODNÍ / VODNĚ-ELEKTRICKÝ (DOKOUPIT TOPNOU TYČ)

Připojení:



A ↓ [mm]	B ↔ [mm]	75/65/20°C [W]	55/45/20°C [W]	Barvy RAL a speciální barvy Cena bez DPH [EUR]	Kód produktu ... Kód konfigurace s. 363
500	865	591	310	409	WGROR050086...
500	1195	812	426	553	WGROR050119...
500	1470	997	523	614	WGROR050147...
580	865	672	334	434	WGROR058086...
580	1195	924	459	545	WGROR058119...
580	1470	1134	563	665	WGROR058147...
1200	260	404	204	269	WGROR120026...
1200	370	565	285	354	WGROR120037...
1200	480	726	366	418	WGROR120048...
1200	590	888	447	477	WGROR120059...
1800	260	573	284	330	WGROR180026...
1800	370	802	398	435	WGROR180037...
1800	480	1031	512	519	WGROR180048...
1800	590	1260	625	590	WGROR180059...



Rolo Room E



Barva je zahrnuta v ceně



výběr připojení v ceně

RADIÁTOR ELEKTRICKÝ (CENA VČETNĚ NÁPLNĚ A ZVOLENÉ TOPNÉ TYČE)

Připojení:



A ↕ [mm]	B ↔ [mm]	Výkon [W]	MEG Cena bez DPH [EUR]	MOA/DRY/ TDY Cena bez DPH [EUR] (MOA IR: +12 EUR) (MOA BLUE: +38 EUR)	ONE Cena bez DPH [EUR] (Nezabudovaná, v 8cm profilu v barvě radiátoru)	REG 2 Cena bez DPH [EUR]	REG 3 Cena bez DPH [EUR]	SIM Cena bez DPH [EUR]	Terma Split třída I Cena bez DPH [EUR] (nezapomeňte si koupit regulátor KTX)	Smart Split třída I Cena bez DPH [EUR] (nezapomeňte si koupit SMART Wi-Fi regulátor VEO)	Kód produktu ... Kód konfigurace s. 366
1200	260	400	330	336	374	311	319	302	289	289	WLROR120026...
1200	370	600	415	421	459	396	404	387	374	374	WLROR120037...
1800	260	600	391	397	435	372	380	363	350	350	WLROR180026...
1800	370	800	496	502	540	477	485	468	455	455	WLROR180037...
1800	480	1000	580	586	624	561	569	552	539	539	WLROR180048...
1800	590	1200	651	657	–	632	640	623	–	608	WLROR180059...

Sherwood H



Barva je zahrnuta v ceně



výběr připojení v ceně

DOPORUČUJEME PRO PŘIPOJENÍ O1 i O8:



Sada krycí integrovaná, Chrom

TGPCR002: 38 EUR

Stránka: 338



Integrovaná sada termostatická s ponornou trubicí, Chrom

WRZT5G5-CR: 151 EUR

WRZT5G6-CR: 151 EUR

Stránka: 298



RADIÁTOR VODNÍ:

Připojení:

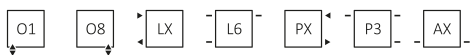

A \updownarrow [mm]	B \leftrightarrow [mm]	75/65/20°C [W]	55/45/20°C [W]	Barvy RAL a speciální barvy Cena bez DPH [EUR]	Kód produktu ... Kód konfigurace s. 363
330	1000	429	222	598	WGSTH033100...
330	1300	558	289	673	WGSTH033130...
330	1600	687	356	768	WGSTH033160...
330	1900	816	422	900	WGSTH033190...
440	1300	701	364	750	WGSTH044130...
440	1600	863	448	843	WGSTH044160...
440	1900	1025	532	975	WGSTH044190...
540	1600	1057	557	937	WGSTH054160...
540	1900	1255	661	1 069	WGSTH054190...

Sherwood V



Barva je zahrnuta v ceně

výběr připojení v ceně

DOPORUČUJEME PRO PŘIPOJENÍ Z1, Z8 i ZX:



Sada krycí integrovaná, Chrom

TGPCR002: 38 EUR

Stránka: 338



Háček bodový KUKA 50, Chrom

WRWKUK001 KCRO: 44 EUR

Stránka: 279



Integrovaná sada termostatická,

Chrom

WRZT5G1-CR: 145 EUR

WRZT5G2-CR: 145 EUR

Stránka: 296



RADIÁTOR VODNÍ / VODNĚ-ELEKTRICKÝ (DOKOUPIT TOPNOU TYČ)

Připojení:



A ↕ [mm]	B ↔ [mm]	75/65/20°C [W]	55/45/20°C [W]	[W]	Barvy RAL a speciální barvy Cena bez DPH [EUR]	Kód produktu ... Kód konfigurace s. 363
1000	330	478	242	600	603	WGSTV100033...
1300	330	602	303	600	681	WGSTV130033...
1300	440	803	404	800	779	WGSTV130044...
1600	330	727	365	800	759	WGSTV160033...
1600	440	969	486	1000	857	WGSTV160044...
1600	540	1190	597	1200	916	WGSTV160054...
1900	330	851	427	800	955	WGSTV190033...
1900	440	1135	569	1200	994	WGSTV190044...
1900	540	1393	698	1500	1 093	WGSTV190054...

Sherwood V E



Barva je zahrnuta v ceně



výběr připojení v ceně

RADIÁTOR ELEKTRICKÝ (CENA VČETNĚ NÁPLNĚ A ZVOLENÉ TOPNÉ TYČE)

Připojení:

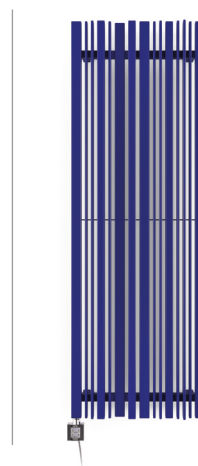

A ↕ [mm]	B ↔ [mm]	Výkon [W]	MEG Cena bez DPH [EUR]	MOA/DRY/ TDY Cena bez DPH [EUR] (MOAIR: +12 EUR) (MOA BLUE: +38 EUR)	ONE Cena bez DPH [EUR] (Nezabudovaná, v 8cm profilu v barvě radiátoru)	REG 2 Cena bez DPH [EUR]	REG 3 Cena bez DPH [EUR]	SIM Cena bez DPH [EUR]	Terma Split třída I Cena bez DPH [EUR] (nezapomeňte si koupit regulátor KTX)	Smart Split třída I Cena bez DPH [EUR] (nezapomeňte si koupit SMART Wi-Fi regulátor VEO)	Kód produktu ... Kód konfigurace s. 366
1000	330	600	708	716	736	686	696	677	662	662	WLSTV100033...
1300	330	600	788	796	815	766	776	756	742	742	WLSTV130033...
1300	440	800	888	896	915	866	876	856	841	841	WLSTV130044...
1600	330	800	868	875	895	846	856	836	821	821	WLSTV160033...
1600	440	1000	968	975	995	946	956	936	921	921	WLSTV160044...
1600	540	1200	1028	1035	–	1005	1015	996	–	981	WLSTV160054...
1900	330	800	1067	1075	1095	1045	1055	1036	1021	1021	WLSTV190033...
1900	440	1200	1107	1115	–	1085	1095	1075	–	1060	WLSTV190044...
1900	540	1500	–	–	–	–	–	1176	–	1161	WLSTV190054...

Simple



Barva je zahrnuta v ceně

výběr připojení v ceně

DOPORUČUJEME PRO PŘIPOJENÍ SX:



Sada tříosová termostatická, Chrom

WRZTCG1-CR: 143EUR

WRZTCG2-CR: 143EUR

Stránka: 294



Sada krycí dvojitá, Chrom

TGPCR001: 27EUR

Stránka: 337



Police SIMPLE - Masivní dřevo

WRPSIM050 KBUK: 50EUR (BUK)

WRPSIM050 KDAB: 56EUR (DUB)

WRPSIM050 KTEK: 118EUR (TEAK)

Stránka: 273



RADIÁTOR VODNÍ / VODNĚ-ELEKTRICKÝ (DOKOUPIT TOPNOU TYČ)

Připojení:

Výška [mm] 480÷1920:

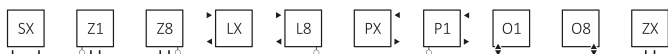

Výška [mm] 720÷1920:



A ↕ [mm]	B ↔ [mm]	Barva ze vzorníku RAL a speciálních barev			Galvanický povrch Chrom			Barvy RAL a speciální barvy Cena bez DPH [EUR]	Chrom Cena bez DPH [EUR]	Kód produktu ... Kód konfigurace s. 363
		75/65/20°C [W]	55/45/20°C [W]	[W]	75/65/20°C [W]	55/45/20°C [W]	[W]			
480	500	173	100	200	121	70	120	232	350	WGSIM048050...
600	500	217	123	200	152	86	120	260	396	WGSIM060050...
720	500	262	145	300	183	102	200	274	435	WGSIM072050...
840	500	306	167	300	214	117	200	289	487	WGSIM084050...
960	500	351	189	400	246	132	300	302	533	WGSIM096050...
1080	500	396	211	400	277	148	300	317	579	WGSIM108050...
1200	500	440	234	400	308	164	300	345	625	WGSIM120050...
1440	500	529	271	600	370	190	400	373	737	WGSIM144050...
1680	500	618	308	600	433	216	400	430	822	WGSIM168050...
1920	500	707	343	800	–	–	–	458	–	WGSIM192050...

RADIÁTOR ELEKTRICKÝ (CENA VČETNĚ NÁPLNĚ A ZVOLENÉ TOPNÉ TYČE)

Připojení:



A ↕ [mm]	B ↔ [mm]	Výkon [W]		MEG Cena bez DPH [EUR]		MOA/DRY/TDY Cena bez DPH [EUR] (MOAIR: + 12 EUR) (MOABLUE: + 38 EUR)		ONE Cena bez DPH [EUR] (Nezabudovaná, v 8cm profilu v barvě radiátoru)		REG 2 Cena bez DPH [EUR]		REG 3 Cena bez DPH [EUR]		SIM Cena bez DPH [EUR]		Terma Split třída I Cena bez DPH [EUR] (nezapomeňte si koupit regulátor KTX)		Smart Split třída I Cena bez DPH [EUR] (nezapomeňte si koupit SMART WI-FI regulátor VEO)		Kód produktu ... Kód konfigurace s. 366
				Barva	Chrom	Barvy RAL a speciální barvy	Chrom	Barvy RAL a speciální barvy	Chrom	Barvy RAL a speciální barvy	Chrom	Barvy RAL a speciální barvy	Chrom	Barvy RAL a speciální barvy	Chrom	Barvy RAL a speciální barvy	Chrom	Barvy RAL a speciální barvy	Chrom	
480	500	200	120	325	445	333	452	352	472	303	423	313	432	293	413	279	398	279	398	WLSIM048050...
600	500	200	120	355	490	362	498	382	517	333	468	343	478	323	458	308	443	308	443	WLSIM060050...
720	500	300	200	368	530	376	537	396	557	346	507	356	517	336	498	322	483	322	483	WLSIM072050...
840	500	300	200	383	581	391	589	410	608	361	559	371	569	351	549	336	534	336	534	WLSIM084050...
960	500	400	300	397	628	404	635	424	655	375	606	384	616	365	596	350	581	350	581	WLSIM096050...
1080	500	400	300	412	673	419	681	439	700	389	651	399	661	380	641	365	627	365	627	WLSIM108050...
1200	500	400	300	440	719	447	726	467	746	418	697	427	707	408	687	393	672	393	672	WLSIM120050...
1440	500	600	400	468	832	475	839	495	859	446	810	456	820	436	800	421	785	421	785	WLSIM144050...
1680	500	600	400	525	917	532	924	552	944	502	895	512	905	493	885	478	870	478	870	WLSIM168050...
1920	500	800	–	553	–	560	–	580	–	531	–	541	–	521	–	506	–	506	–	WLSIM192050...

Simple One



Barva je zahrnuta v ceně



výběr připojení v ceně



TŘÍDA I



45-60°C/2



P-W-U



120-1000W



IR



IPx5



2h/1



IR

SADA OBSAHUJE:

Radiátor se zabudovanou topnou tyčičí One. Funkce topné tyče ONE: Stránka 209.

DOPORUČUJEME PRO PŘIPOJENÍ S1 i S8:



Integrovaná sada termostatická s ponornou trubicí, Chrom

WRZT5G5-CR: 151EUR

WRZT5G6-CR: 151EUR

Stránka: 298



Sada krycí integrovaná, Chrom

TGPCR002: 38 EUR

Stránka: 338



Police SIMPLE - Masivní dřevo

WRPSIM050 KBUK: 50EUR (BUK)

WRPSIM050 KDAB: 56EUR (DUB)

WRPSIM050 KTEK: 118EUR (TEAK)

Stránka: 273



RADIÁTOR VODNĚ-ELEKTRICKÝ (CENA VČETNĚ ZABUDOVANÉ TOPNÉ TYČE ONE)

Připojení:

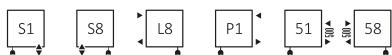

Vyber druh kabelu:

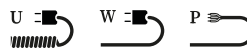

A ↓ [mm]	B ↔ [mm]	Barva ze vzorníku RAL a speciálních barev			Galvanický povrch Chrom			Barvy RAL a speciální barvy (Cena bez DPH [EUR])	Chrom (Cena bez DPH [EUR])	Kód produktu ... Kód konfigurace s. 364
		75/65/20°C [W]	55/45/20°C [W]	[W]	75/65/20°C [W]	55/45/20°C [W]	[W]			
720	500	262	145	300	183	102	200	371	532	WZSIE072050...
840	500	306	167	300	214	117	200	386	584	WZSIE084050...
960	500	351	189	400	246	132	300	399	630	WZSIE096050...
1080	500	396	211	400	277	148	300	414	676	WZSIE108050...
1200	500	440	234	400	308	164	300	442	721	WZSIE120050...
1440	500	529	271	600	370	190	400	471	834	WZSIE144050...
1680	500	618	308	600	433	216	400	527	919	WZSIE168050...
1920	500	707	343	800	-	-	-	555	-	WZSIE192050...

Simple One

RADIÁTOR ELEKTRICKÝ (CENA VČETNĚ NÁPLNĚ A ZABUDOVANÉ TOPNÉ TYČE ONE)

Připojení:



A ↕ [mm]	B ↔ [mm]	Výkon [W]		Barvy RAL a speciální barvy Cena bez DPH [EUR]	Chrom Cena bez DPH [EUR]	Kód produktu ... Kód konfigurace s. 365
		Barva	Chrom			
720	500	300	200	389	550	WWSIE072050...
840	500	300	200	404	602	WWSIE084050...
960	500	400	300	418	649	WWSIE096050...
1080	500	400	300	432	694	WWSIE108050...
1200	500	400	300	461	740	WWSIE120050...
1440	500	600	400	489	853	WWSIE144050...
1680	500	600	400	546	938	WWSIE168050...
1920	500	800	–	574	–	WWSIE192050...

Spiro

RADIÁTOR ELEKTRICKÝ (CENA VČETNĚ VYHŘÍVÁNÍ TOPNÝM KABELEM)

Připojení:



Vyber druh kabelu:

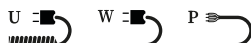

A ↕ [mm]	B ↔ [mm]	Výkon [W]		Barvy RAL a speciální barvy Cena bez DPH [EUR]	Chrom Cena bez DPH [EUR]	Kód produktu ... Kód konfigurace s. 367
		Barva	Chrom			
566	450	110	80	231	347	WSSPI056045...
794	450	165	110	252	406	WSSPI079045...
1062	450	205	130	273	465	WSSPI106045...

* Radiátor s topným kabelem v celém těle. Druh kabelu zvolte W, P nebo U. Viz Legenda Druhů kabelů. Stránka 206

Simple DW (dřívíci stěna kolmá)



Barva je zahrnuta v ceně

výběr připojení v ceně

DOPORUČUJEME PRO PŘIPOJENÍ ZX i Z1:



Integrovaná sada termostatická ventil přímý, Chrom

WRZT5G3-CR: 146 EUR

WRZT5G4-CR: 146 EUR

Stránka: 296



Sada krycí integrovaná, Chrom

TGPCR002: 38 EUR

Stránka: 338



Police SIMPLE - Masivní dřevo

WRPSIM050 KBUK: 50 EUR (BUK)

WRPSIM050 KDAB: 56 EUR (DUB)

WRPSIM050 KTEK: 118 EUR (TEAK)

Stránka: 273



RADIÁTOR VODNÍ / VODNĚ-ELEKTRICKÝ (DOKOUPIT TOPNOU TYČ)

Připojení:



A ↕ [mm]	B ↔ [mm]	75/65/20°C [W]	55/45/20°C [W]	 [W]	Barvy RAL a speciální barvy Cena bez DPH [EUR]	Kód produktu ... Kód konfigurace s. 363
1515	500	529	271	600	448	WGSDW151050...
1755	500	618	308	600	478	WGSDW175050...
1995	500	707	343	800	507	WGSDW199050...

RADIÁTOR ELEKTRICKÝ (CENA VČETNĚ NÁPLNĚ A ZVOLENÉ TOPNÉ TYČE)

Připojení:



A ↕ [mm]	B ↔ [mm]	Výkon [W]	MEG Cena bez DPH [EUR]	MOA/DRY/ TDY Cena bez DPH [EUR] (MOA IR: +12 EUR) (MOA BLUE: +38 EUR)	ONE Cena bez DPH [EUR] (Nezabudovaná, v 8cm profilu v barvě radiátoru)	REG 2 Cena bez DPH [EUR]	REG 3 Cena bez DPH [EUR]	SIM Cena bez DPH [EUR]	Terma Split třída I Cena bez DPH [EUR] (nezapomeňte si koupit regulátor KTX)	Smart Split třída I Cena bez DPH [EUR] (nezapomeňte si koupit SMART WI-FI regulátor VEO)	Kód produktu ... Kód konfigurace s. 366
1515	500	600	543	550	570	521	531	511	496	496	WLSDW151050...
1755	500	600	573	580	600	550	560	541	526	526	WLSDW175050...
1995	500	800	602	609	629	580	590	570	555	555	WLSDW199050...

Stand



Barva je zahrnuta v ceně

výběr připojení v ceně

DOPORUČUJEME PRO PŘIPOJENÍ SX:



Sada tříosová termostatická, Chrom

WRZTCG1-CR: 143EUR

WRZTCG2-CR: 143EUR

Stránka: 294



Sada krycí dvojitá, Chrom

TGPCR001: 27EUR

Stránka: 337



Police STAND - Masivní dřevo

WRPSCA050 KBUK: EUR 48 (BUK)

WRPSCA050 KDAB: EUR 65 (DUB)

WRPSCA050 KTEK: EUR 176 (TEAK)

Stránka: 274



RADIÁTOR VODNÍ / VODNĚ-ELEKTRICKÝ (DOKOUPIT TOPNOU TYČ)

Připojení:

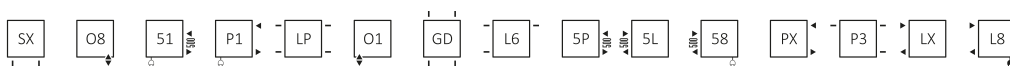

A ↕ [mm]	B ↔ [mm]	75/65/20°C [W]	55/45/20°C [W]	[W]	Barvy RAL a speciální barvy Cena bez DPH [EUR]	Kód produktu ... Kód konfigurace s. 363
920	300	383	207	400	365	WGSCA092030...
920	400	434	234	400	376	WGSCA092040...
920	500	486	262	600	388	WGSCA092050...
1150	300	480	259	400	387	WGSCA115030...
1150	400	547	295	600	402	WGSCA115040...
1150	500	615	331	600	416	WGSCA115050...
1380	300	577	310	600	417	WGSCA138030...
1380	400	660	355	600	434	WGSCA138040...
1380	500	743	399	800	451	WGSCA138050...
1610	300	674	362	800	438	WGSCA161030...
1610	400	773	415	800	456	WGSCA161040...
1610	500	872	468	800	475	WGSCA161050...

Stand E



Barva je zahrnuta v ceně



výběr připojení v ceně

DOPORUČUJEME PRO PŘIPOJENÍ E1 i E8:



Police STAND - Masivní dřevo
WRPSCA030 KBUK: EUR 43 (BUK)
WRPSCA030 KDAB: EUR 58 (DUB)
WRPSCA030 KTEK: EUR 126 (TEAK)
Stránka: 274



Police STAND - Masivní dřevo
WRPSCA040 KBUK: EUR 45 (BUK)
WRPSCA040 KDAB: EUR 62 (DUB)
WRPSCA040 KTEK: EUR 144 (TEAK)
Stránka: 274



Police STAND - Masivní dřevo
WRPSCA050 KBUK: EUR 48 (BUK)
WRPSCA050 KDAB: EUR 65 (DUB)
WRPSCA050 KTEK: EUR 176 (TEAK)
Stránka: 274



RADIÁTOR ELEKTRICKÝ (CENA VČETNĚ NÁPLNĚ A ZVOLENÉ TOPNÉ TYČE)

Připojení:

E1

E8

A ↕ [mm]	B ↔ [mm]	Výkon [W]	MEG Cena bez DPH [EUR]	MOA/DRY/ TDY Cena bez DPH [EUR] (MOAIR: +12 EUR) (MOABLUE: +38 EUR)	ONE Cena bez DPH [EUR] (Nezabudovaná, v 8cm profilu v barvě radiátoru)	REG 2 Cena bez DPH [EUR]	REG 3 Cena bez DPH [EUR]	SIM Cena bez DPH [EUR]	Terma Split třída I Cena bez DPH [EUR] (nezapomeňte si koupit regulátor KTX)	Smart Split třída I Cena bez DPH [EUR] (nezapomeňte si koupit regulátor SMART Wi-Fi regulátor VEO)	Kód produktu ... Kód konfigurace s. 366
920	300	300	460	467	487	438	447	428	413	413	WLSCA092030
920	400	400	471	478	498	449	459	439	424	424	WLSCA092040
920	500	400	482	490	510	460	470	450	436	436	WLSCA092050
1150	300	400	482	489	509	460	470	450	435	435	WLSCA115030
1150	400	400	496	504	523	474	484	464	450	450	WLSCA115040
1150	500	600	510	518	537	488	498	478	464	464	WLSCA115050
1380	300	400	512	519	539	490	499	480	465	465	WLSCA138030
1380	400	600	529	536	556	507	517	497	482	482	WLSCA138040
1380	500	600	546	553	573	524	534	514	499	499	WLSCA138050
1610	300	600	532	540	559	510	520	500	486	486	WLSCA161030
1610	400	600	550	558	578	528	538	519	504	504	WLSCA161040
1610	500	800	570	577	597	548	558	538	523	523	WLSCA161050

Strato



Barva je zahrnuta v ceně



výběr připojení v ceně

DOPORUČUJEME PRO PŘIPOJENÍ SX:



Sada tříosová termostatická, Chrom

WRZTCG1-CR: 143EUR

WRZTCG2-CR: 143EUR

Stránka: 294



Sada krycí dvojitá, Chrom

TGPCR001: 27EUR

Stránka: 337



RADIÁTOR VODNÍ

Připojení:

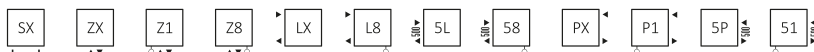

A ↑ [mm]	B ↔ [mm]	75/65/20°C [W]	55/45/20°C [W]	Barvy RAL a speciální barvy Cena bez DPH [EUR]	Kód produktu ... Kód konfigurace s. 363
380	400			154	WGB39038040...
380	500			159	WGB39038050...
380	600			163	WGB39038060...
700	400			183	WGB39070040...
700	500			191	WGB39070050...
700	600			198	WGB39070060...
1020	400			205	WGB39102040...
1020	500			217	WGB39102050...
1020	600			228	WGB39102060...
1340	400			231	WGB39134040...
1340	500			244	WGB39134050...
1340	600			259	WGB39134060...
1660	400			256	WGB39166040...
1660	500			274	WGB39166050...
1660	600			292	WGB39166060...

RADIÁTOR ELEKTRICKÝ (CENA VČETNĚ NÁPLNĚ A ZVOLENÉ TOPNÉ TYČE)

Připojení:



A ↕ [mm]	B ↔ [mm]	Výkon [W]	MEG Cena bez DPH [EUR]	MOA/DRY/ TDY Cena bez DPH [EUR] (MOA IR: +12 EUR) (MOA BLUE: +38 EUR)	ONE Cena bez DPH [EUR] (Nezabudovaná, v 8cm profilu v barvě radiátoru)	REG 2 Cena bez DPH [EUR]	REG 3 Cena bez DPH [EUR]	SIM Cena bez DPH [EUR]	Terma Split třída I Cena bez DPH [EUR] (nezapomeňte si koupit regulátor KTX)	Smart Split třída I Cena bez DPH [EUR] (nezapomeňte si koupit SMART Wi-Fi regulátor VEO)	Kód produktu ... Kód konfigurace s. 366
700	400		278	285	305	256	266	246	231	231	WLB39070040...
700	500		286	293	313	264	274	254	239	239	WLB39070050...
700	600		293	300	320	271	281	261	246	246	WLB39070060...
1020	400		300	307	327	278	288	268	253	253	WLB39102040...
1020	500		312	319	339	290	300	280	265	265	WLB39102050...
1020	600		323	330	350	301	311	291	276	276	WLB39102060...
1340	400		326	333	353	304	314	294	279	279	WLB39134040...
1340	500		339	346	366	317	327	307	292	292	WLB39134050...
1340	600		354	361	381	332	342	322	307	307	WLB39134060...
1660	400		351	358	378	329	339	319	304	304	WLB39166040...
1660	500		369	376	396	347	357	337	322	322	WLB39166050...
1660	600		387	394	414	365	375	355	340	340	WLB39166060...



Barva je zahrnuta v ceně



výběr připojení v ceně

DOPORUČUJEME PRO PŘIPOJENÍ Z1, Z8 i ZX:



Sada krycí integrovaná, Chrom

TGPCR002: 38 EUR

Stránka: 338



Integrovaná sada termostatická,

Chrom

WRZT5G1-CR: 145 EUR

WRZT5G2-CR: 145 EUR

Stránka: 296



RADIÁTOR VODNÍ

Připojení:



A ↕ [mm]	B ↔ [mm]	75/65/20°C [W]	55/45/20°C [W]	Barvy RAL a speciální barvy Cena bez DPH [EUR]	Kód produktu ... Kód konfigurace s. 363
621	465	258	139	508	WGQ09062046...
932	465	385	205	593	WGQ09093046...
1244	465	512	269	627	WGQ09124046...
1555	465	640	332	731	WGQ09155046...



Barva je zahrnuta v ceně

výběr připojení v ceně

DOPORUČUJEME PRO PŘIPOJENÍ YL, YP, Z1, Z8 i ZX:



Integrovaná sada termostatická,

Chrom

WRZT5G1-CR: 145 EUR

WRZT5G2-CR: 145 EUR

Stránka: 296



Sada krycí integrovaná, Chrom

TGPCR002: 38 EUR

Stránka: 338



Police TRIGA - Masivní dřevo 680 mm

WRPTRG068 KBUK: 87 EUR (BUK)

WRPTRG068 KDAB: 90 EUR (DUB)

WRPTRG068 KTEK: 188 EUR (TEAK)

Stránka: 275



RADIÁTOR VODNÍ / VODNĚ-ELEKTRICKÝ (DOKOUPIT TOPNOU TYČ)

Připojení:

Výška [mm] 560÷1900:

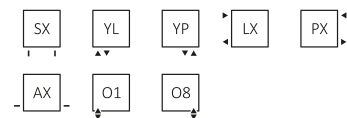

Výška [mm] 560÷610:

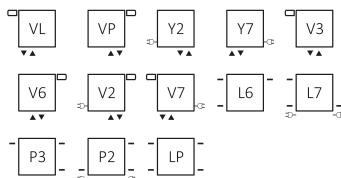

Výška [mm] 900÷1900:

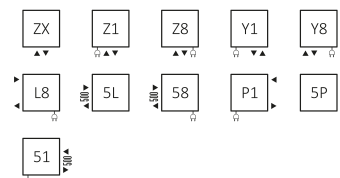

A ↕ [mm]	B ↔ [mm]	75/65/20°C [W]	55/45/20°C [W]	[W]	Barvy RAL a speciální barvy Cena bez DPH [EUR]	Kód produktu ... Kód konfigurace s. 363
560	480	356	192	400	498	WGTRG056048...
560	680	504	272	600	591	WGTRG056068...
560	880	652	352	600	684	WGTRG056088...
560	1080	800	431	800	794	WGTRG056108...
560	1280	948	511	1000	918	WGTRG056128...
610	480	391	210	400	528	WGTRG061048...
610	680	554	298	600	607	WGTRG061068...
610	880	717	385	800	684	WGTRG061088...
610	1080	880	473	800	841	WGTRG061108...
610	1280	1043	560	1000	965	WGTRG061128...
900	380	459	242	400	451	WGTRG090038...
900	480	580	306	600	528	WGTRG090048...
900	580	701	370	800	607	WGTRG090058...
900	680	821	433	800	715	WGTRG090068...
1300	380	652	339	600	544	WGTRG130038...

A ↕ [mm]	B ↔ [mm]	75/65/20°C [W]	55/45/20°C [W]	 [W]	Barvy RAL a speciální barvy Cena bez DPH [EUR]	Kód produktu ... Kód konfigurace s. 363
1300	480	824	429	800	622	WGTRG130048...
1300	580	996	518	1000	715	WGTRG130058...
1300	680	1168	608	1200	794	WGTRG130068...
1700	380	850	437	800	591	WGTRG170038...
1700	480	1074	552	1000	668	WGTRG170048...
1700	580	1298	667	1200	762	WGTRG170058...
1700	680	1521	781	1500	871	WGTRG170068...
1900	380	961	492	1000	638	WGTRG190038...
1900	480	1202	615	1200	715	WGTRG190048...
1900	580	1442	737	1500	825	WGTRG190058...
1900	680	1682	860	1500	934	WGTRG190068...

Triga E



Barva je zahrnuta v ceně



výběr připojení v ceně

DOPORUČUJEME:



Police TRIGA - Masivní dřevo 680

mm

WRPTRG068 KBUK: 87 EUR (BUK)

WRPTRG068 KDAB: 90 EUR (DUB)

WRPTRG068 KTEK: 188 EUR (TEAK)

Stránka: 275

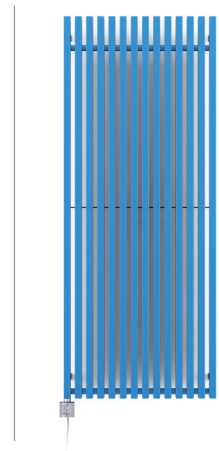

RADIÁTOR ELEKTRICKÝ (CENA VČETNĚ NÁPLNĚ A ZVOLENÉ TOPNÉ TYČE)

Připojení:

Výška [mm] 900 ÷ 1900:

Výška 560 mm ÷ 610:

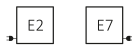

A ↓ [mm]	B ↔ [mm]	Výkon [W]	MEG Cena bez DPH [EUR]	MOA/DRY/ TDY Cena bez DPH [EUR] (MOA IR: +12 EUR) (MOA BLUE: +38 EUR)	ONE Cena bez DPH [EUR] (Nezabudovaná, v 8cm profilu v barvě radiátoru)	REG 2 Cena bez DPH [EUR]	REG 3 Cena bez DPH [EUR]	SIM Cena bez DPH [EUR]	Terma Split třída I Cena bez DPH [EUR] (nezapomeňte si koupit regulátor KTX)	Smart Split třída I Cena bez DPH [EUR] (nezapomeňte si koupit SMART Wi-Fi regulátor VEO)	Kód produktu ... Kód konfigurace s. 366
560	480	400	592	600	619	570	580	560	546	546	WLTRG056048...
560	680	600	686	693	713	664	673	654	639	639	WLTRG056068...
560	880	600	779	787	806	757	767	747	732	732	WLTRG056088...
560	1080	800	889	896	916	866	876	857	842	842	WLTRG056108...
560	1280	1000	1013	1020	1040	991	1000	981	966	966	WLTRG056128...
610	480	400	623	630	650	601	611	591	576	576	WLTRG061048...
610	680	600	702	709	729	680	689	670	655	655	WLTRG061068...
610	880	800	779	787	806	757	767	747	732	732	WLTRG061088...
610	1080	800	935	943	962	913	923	903	889	889	WLTRG061108...
610	1280	1000	1060	1067	1087	1037	1047	1028	1013	1013	WLTRG061128...
900	380	400	546	553	573	523	533	514	499	499	WLTRG090038...
900	480	600	623	630	650	601	611	591	576	576	WLTRG090048...
900	580	800	702	709	729	680	689	670	655	655	WLTRG090058...
900	680	800	810	817	837	788	798	778	763	763	WLTRG090068...
1300	380	600	639	646	666	617	627	607	592	592	WLTRG130038...

Triga E

A ↕ [mm]	B ↔ [mm]	Výkon [W]	MEG Cena bez DPH [EUR]	MOA/DRY/ TDY Cena bez DPH [EUR] (MOAIR: +12 EUR) (MOABLUE: +38 EUR)	ONE Cena bez DPH [EUR] (Nezabudovaná, v 8cm profilu v barvě radiátoru)	REG 2 Cena bez DPH [EUR]	REG 3 Cena bez DPH [EUR]	SIM Cena bez DPH [EUR]	Terma Split třída I Cena bez DPH [EUR] (nezapomeňte si koupit regulátor KTX)	Smart Split třída I Cena bez DPH [EUR] (nezapomeňte si koupit SMART Wi-Fi regulátor VEO)	Kód produktu ... Kód konfigurace s. 366
1300	480	800	716	724	743	694	704	684	670	670	WLTRG130048...
1300	580	1000	810	817	837	788	798	778	763	763	WLTRG130058...
1300	680	1200	889	896	916	866	876	857	842	842	WLTRG130068...
1700	380	800	686	693	713	664	673	654	639	639	WLTRG170038...
1700	480	1000	763	771	790	741	751	731	716	716	WLTRG170048...
1700	580	1200	857	864	–	834	844	825	–	810	WLTRG170058...
1700	680	1500	–	–	–	–	–	934	–	919	WLTRG170068...
1900	380	1000	732	740	759	710	720	700	686	686	WLTRG190038...
1900	480	1200	810	817	–	788	798	778	–	763	WLTRG190048...
1900	580	1500	–	–	–	–	–	887	–	872	WLTRG190058...
1900	680	1500	–	–	–	–	–	997	–	982	WLTRG190068...

Triga AN



Barva je zahrnuta v ceně



výběr připojení v ceně

DOPORUČUJEME PRO PŘIPOJENÍ ZX:



Integrovaná sada termostatická,

Chrom

WRZT5G1-CR: 145 EUR

WRZT5G2-CR: 145 EUR

Stránka: 296



Sada krycí integrovaná, Chrom

TGPCR002: 38 EUR

Stránka: 338



RADIÁTOR VODNÍ

Připojení:



A ↕ [mm]	B ↔ [mm]	75/65/20°C [W]	55/45/20°C [W]	 [W]	Barvy RAL a speciální barvy Cena bez DPH [EUR]	Kód produktu ... Kód konfigurace s. 363
1700	280	953	492	1000	816	WGVER170028...
1900	280	1053	548	1000	878	WGVER190028...

Triga AN E



Barva je zahrnuta v ceně



výběr připojení v ceně

RADIÁTOR ELEKTRICKÝ (CENA VČETNĚ NÁPLNĚ A ZVOLENÉ TOPNÉ TYČE)

Připojení:



A ↕ [mm]	B ↔ [mm]	Výkon [W]	MEG Cena bez DPH [EUR]	MOA/DRY/ TDY Cena bez DPH [EUR] (MOAIR: +12 EUR) (MOA BLUE: +38 EUR)	ONE Cena bez DPH [EUR] (Nezabudovaná, v 8cm profilu v barvě radiátoru)	REG 2 Cena bez DPH [EUR]	REG 3 Cena bez DPH [EUR]	SIM Cena bez DPH [EUR]	Terma Split třída I Cena bez DPH [EUR] (nezapomeňte si koupit regulátor KTX)	Smart Split třída I Cena bez DPH [EUR] (nezapomeňte si koupit SMART Wi-Fi regulátor VEO)	Kód produktu ... Kód konfigurace s. 366
1700	280	1000	911	918	938	889	898	879	864	864	WLVER170028...
1900	280	1000	972	980	999	950	960	940	925	925	WLVER190028...

Triga ANC



Barva je zahrnuta v ceně



výběr připojení v ceně

DOPORUČUJEME PRO PŘIPOJENÍ YL i YP:



Integrovaná sada termostatická,

Chrom

WRZT5G1-CR: 145 EUR

WRZT5G2-CR: 145 EUR

Stránka: 296



Sada krycí integrovaná, Chrom

TGPCR002: 38 EUR

Stránka: 338

RADIÁTOR VODNÍ:

Připojení:



A ↕ [mm]	B ↔ [mm]	75/65/20°C [W]	55/45/20°C [W]	 [W]	Barvy RAL a speciální barvy Cena bez DPH [EUR]	Kód produktu ... Kód konfigurace s. 363
1700	280	953	492	1000	1 024	WGVEC170028...
1900	280	1053	548	1000	1 152	WGVEC190028...



Triga ANC E



Barva je zahrnuta v ceně



výběr připojení v ceně

RADIÁTOR ELEKTRICKÝ (CENA VČETNĚ NÁPLNĚ A ZVOLENÉ TOPNÉ TYČE)

Připojení:

EX

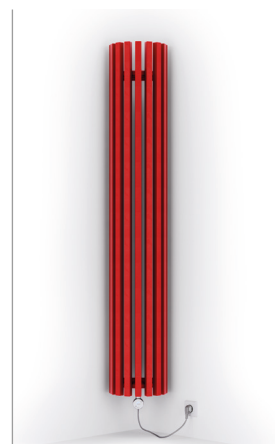

A ↕ [mm]	B ↔ [mm]	Výkon [W]	MEG Cena bez DPH [EUR]	MOA/DRY/ TDY Cena bez DPH [EUR] (MOAIR: +12 EUR) (MOA BLUE: +38 EUR)	ONE Cena bez DPH [EUR] (Nezabudovaná, v 8cm profilu v barvě radiátoru)	REG 2 Cena bez DPH [EUR]	REG 3 Cena bez DPH [EUR]	SIM Cena bez DPH [EUR]	Terma Split třída I Cena bez DPH [EUR] (nezapomeňte si koupit regulátor KTX)	Smart Split třída I Cena bez DPH [EUR] (nezapomeňte si koupit SMART Wi-Fi regulátor VEO)	Kód produktu ... Kód konfigurace s. 366
1700	280	1000	1119	1126	1146	1096	1106	1087	1072	1072	WLVEC170028...
1900	280	1000	1246	1254	1273	1224	1234	1214	1200	1200	WLVEC190028...

Triga AW



Barva je zahrnuta v ceně



výběr připojení v ceně

DOPORUČUJEME PRO PŘIPOJENÍ ZX:



Integrovaná sada termostatická,

Chrom

WRZT5G1-CR: 145 EUR

WRZT5G2-CR: 145 EUR

Stránka: 296



Sada krycí integrovaná, Chrom

TGPCR002: 38 EUR

Stránka: 338



Háček bodový ZIP V 30,
Chrom

WRWZIP012 KCRO: 44 EUR

Stránka: 281



RADIÁTOR VODNÍ:

Připojení:



A ↕ [mm]	B ↔ [mm]	75/65/20°C [W]	55/45/20°C [W]	 [W]	Barvy RAL a speciální barvy Cena bez DPH [EUR]	Kód produktu ... Kód konfigurace s.363
1700	430	1122	583	1200	1 024	WGVRA170043...
1900	430	1255	652	1200	1 152	WGVRA190043...

Triga AW E



Barva je zahrnuta v ceně



výběr připojení v ceně

RADIÁTOR ELEKTRICKÝ (CENA VČETNĚ NÁPLNĚ A ZVOLENÉ TOPNÉ TYČE)

Připojení:

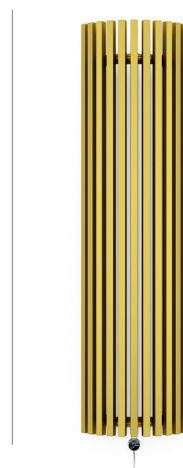

A ↕ [mm]	B ↔ [mm]	Výkon [W]	MEG Cena bez DPH [EUR]	MOA/DRY/ TDY Cena bez DPH [EUR] (MOA IR: +12 EUR) (MOA BLUE: +38 EUR)	ONE Cena bez DPH [EUR] (Nezabudovaná, v 8cm profilu v barvě radiátoru)	REG 2 Cena bez DPH [EUR]	REG 3 Cena bez DPH [EUR]	SIM Cena bez DPH [EUR]	Terma Split třída I Cena bez DPH [EUR] (nezapomeňte si koupit regulátor KTX)	Smart Split třída I Cena bez DPH [EUR] (nezapomeňte si koupit SMART Wi-Fi regulátor VEO)	Kód produktu ... Kód konfigurace s. 366
1700	430	1200	1119	1126	–	1096	1106	1087	–	1072	WLVRA170043...
1900	430	1200	1246	1254	–	1224	1234	1214	–	1199	WLVRA190043...

Triga M



Barva je zahrnuta v ceně

výběr připojení v ceně

DOPORUČUJEME PRO PŘIPOJENÍ SX:



Sada tříosová termostatická s možností montáže topné tyče skrz ventil, Chrom

WRZTCG4-CR: 147 EUR

WRZTCG5-CR: 147 EUR

Stránka: 295



Sada krycí dvojitá, Chrom

TGPCR001: 27 EUR

Stránka: 337



Topná tyč KTX3, Chrom

WEKT3*: 102 EUR

Stránka: 254



RADIÁTOR VODNÍ / VODNĚ-ELEKTRICKÝ (DOKOUPIT TOPNOU TYČ)

Připojení:



A ↕ [mm]	B ↔ [mm]	75/65/20°C [W]	55/45/20°C [W]	[W]	Barvy RAL a speciální barvy Cena bez DPH [EUR]	Kód produktu ... Kód konfigurace s.363
1700	680	646	332	600	662	WGTRL170068...
1700	780	850	437	800	737	WGTRL170078...
1700	880	1074	552	1000	828	WGTRL170088...
1900	680	721	369	800	708	WGTRL190068...
1900	780	961	492	1000	783	WGTRL190078...
1900	880	1202	615	1200	887	WGTRL190088...

Triga M E



Barva je zahrnuta v ceně



výběr připojení v ceně

RADIÁTOR ELEKTRICKÝ (CENA VČETNĚ NÁPLNĚ A ZVOLENÉ TOPNÉ TYČE)

Připojení:

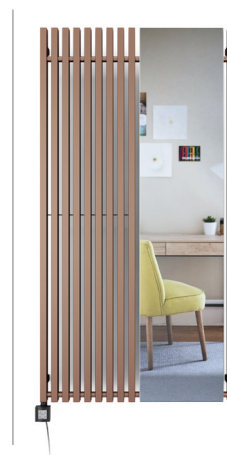

A ↕ [mm]	B ↔ [mm]	Výkon [W]	MEG Cena bez DPH [EUR]	MOA/DRY/ TDY Cena bez DPH [EUR] (MOAIR: +12 EUR) (MOA BLUE: +38 EUR)	ONE Cena bez DPH [EUR] (Nezabudovaná, v 8cm profilu v barvě radiátoru)	REG 2 Cena bez DPH [EUR]	REG 3 Cena bez DPH [EUR]	SIM Cena bez DPH [EUR]	Terma Split třída I Cena bez DPH [EUR] (nezapomeňte si koupit regulátor KTX)	Smart Split třída I Cena bez DPH [EUR] (nezapomeňte si koupit SMART WI-FI regulátor VEO)	Kód produktu ... Kód konfigurace s. 366
1700	680	600	757	764	784	735	745	725	710	710	WLTRL170068...
1700	780	800	832	839	859	810	820	800	785	785	WLTRL170078...
1700	880	1000	922	929	949	900	909	890	875	875	WLTRL170088...
1900	680	800	803	810	830	780	790	771	756	756	WLTRL190068...
1900	780	1000	876	884	903	854	864	844	830	830	WLTRL190078...
1900	880	1200	982	989	–	960	970	950	–	935	WLTRL190088...

Tune HSD



Barva je zahrnuta v ceně



výběr připojení v ceně

DOPORUČUJEME PRO PŘIPOJENÍ YL i YP:



Integrovaná sada termostatická ventil přímý, Chrom

WRZT5G3-CR: 146 EUR

WRZT5G4-CR: 146 EUR

Stránka: 296



Sada krycí integrovaná, Chrom

TGPCR002: 38 EUR

Stránka: 338



RADIÁTOR VODNÍ:

Připojení:



A ↕ [mm]	B ↔ [mm]	75/65/20°C [W]	55/45/20°C [W]	Barvy RAL a speciální barvy Cena bez DPH [EUR]	Kód produktu ... Kód konfigurace s. 363
300	1000	421	229	506	WGTUH030100...
300	1400	589	320	534	WGTUH030140...
390	1000	564	305	562	WGTUH039100...
390	1400	790	428	603	WGTUH039140...

Tune VWD



Barva je zahrnuta v ceně

výběr připojení v ceně

DOPORUČUJEME PRO PŘIPOJENÍ ZX:



Integrovaná sada termostatická,
Chrom

 WRZT5G1-CR: 145 EUR

 WRZT5G2-CR: 145 EUR

Stránka: 296



Sada krycí integrovaná, Chrom

TGPCR002: 38 EUR

Stránka: 338

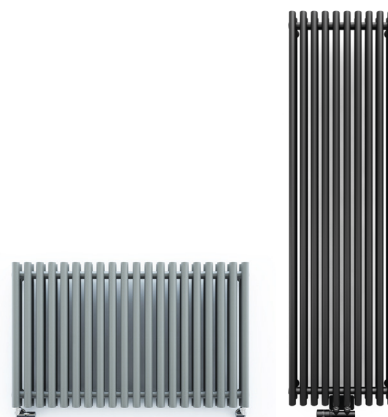

RADIÁTOR VODNÍ / VODNĚ-ELEKTRICKÝ (DOKOUPIT TOPNOU TYČ)

Připojení:

Výška [mm] 600÷1800:

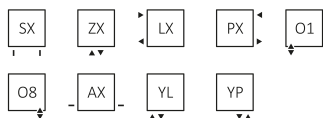

Výška [mm] 600:

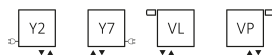

Výška [mm] 1800:

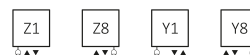

A ↕ [mm]	B ↔ [mm]	75/65/20°C [W]	55/45/20°C [W]	 [W]	Barvy RAL a speciální barvy Cena bez DPH [EUR]	Kód produktu ... Kód konfigurace s. 363
600	590	725	378	800	789	WGTUV060059...
600	790	967	504	1000	971	WGTUV060079...
600	990	1209	630	1200	1 153	WGTUV060099...
600	1190	1450	756	1500	1 336	WGTUV060119...
600	1390	1693	883	1500	1 518	WGTUV060139...
600	1590	1934	1008	–	1 700	WGTUV060159...
1800	190	645	326	600	557	WGTUV180019...
1800	290	967	489	1000	667	WGTUV180029...
1800	390	1289	652	1200	757	WGTUV180039...
1800	490	1612	815	1500	850	WGTUV180049...
1800	590	1934	978	1800	975	WGTUV180059...
1800	690	2257	1141	2000	1 093	WGTUV180069...

Tune VWD E



Barva je zahrnuta v ceně



výběr připojení v ceně

RADIÁTOR ELEKTRICKÝ (CENA VČETNĚ NÁPLNĚ A ZVOLENÉ TOPNÉ TYČE)

Připojení:

Výška [mm] 600:



Výška [mm] 1800:

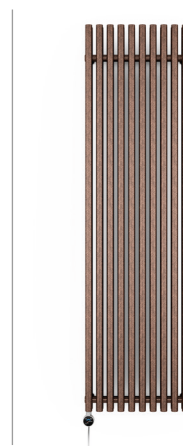

A ↕ [mm]	B ↔ [mm]	Výkon [W]	MEG Cena bez DPH [EUR]	MOA/DRY/ TDY Cena bez DPH [EUR] (MOA IR: +12 EUR) (MOA BLUE: +38 EUR)	ONE Cena bez DPH [EUR] (Nezabudovaná, v 8cm profilu v barvě radiátoru)	REG 2 Cena bez DPH [EUR]	REG 3 Cena bez DPH [EUR]	SIM Cena bez DPH [EUR]	Terma Split třída I Cena bez DPH [EUR] (nezapomeňte si koupit regulátor KTX)	Smart Split třída I Cena bez DPH [EUR] (nezapomeňte si koupit SMART Wi-Fi regulátor VEO)	Kód produktu ... Kód konfigurace s. 366
600	590	800	884	891	911	862	871	852	837	837	WLTUV060059...
600	790	1000	1066	1073	1093	1044	1053	1034	1019	1019	WLTUV060079...
600	990	1200	1248	1255	–	1225	1235	1216	–	1201	WLTUV060099...
600	1190	1500	–	–	–	–	–	1399	–	1384	WLTUV060119...
600	1390	1500	–	–	–	–	–	1581	–	1566	WLTUV060139...
600	1590	1500	–	–	–	–	–	1763	–	1748	WLTUV060159...
1800	190	800	652	659	679	630	640	620	605	605	WLTUV180019...
1800	290	1000	762	769	789	740	750	730	715	715	WLTUV180029...
1800	390	1200	852	859	–	830	840	820	–	805	WLTUV180039...
1800	490	1500	–	–	–	–	–	912	–	897	WLTUV180049...
1800	590	1800	–	–	–	–	–	–	–	1023	WLTUV180059...
1800	690	2000	–	–	–	–	–	–	–	1140	WLTUV180069...

Tune VWS



Barva je zahrnuta v ceně

výběr připojení v ceně

DOPORUČUJEME PRO PŘIPOJENÍ ZX:



Integrovaná sada termostatická,

Chrom

WRZT5G1-CR: 145 EUR

WRZT5G2-CR: 145 EUR

Stránka: 296



Sada krycí integrovaná, Chrom

TGPCR002: 38 EUR

Stránka: 338

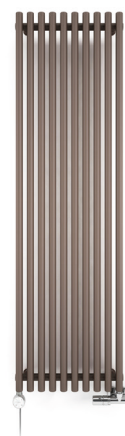

RADIÁTOR VODNÍ / VODNĚ-ELEKTRICKÝ (DOKOUPIT TOPNOU TYČ)

Připojení:

Výška [mm] 600÷1800:

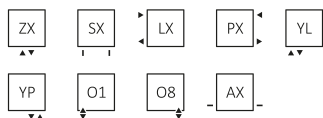

Výška [mm] 600:

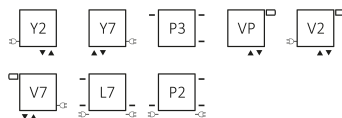

Výška [mm] 1800:

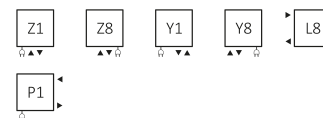

A ↕ [mm]	B ↔ [mm]	75/65/20°C [W]	55/45/20°C [W]	[W]	Barvy RAL a speciální barvy Cena bez DPH [EUR]	Kód produktu ... Kód konfigurace s. 363
600	590	450	240	400	514	WGTSV060059...
600	790	602	321	600	593	WGTSV060079...
600	990	752	401	800	675	WGTSV060099...
600	1190	902	481	1000	772	WGTSV060119...
600	1390	1053	561	1000	852	WGTSV060139...
600	1590	1203	641	1200	933	WGTSV060159...
1800	290	608	305	600	496	WGTSV180029...
1800	390	800	427	800	591	WGTSV180039...
1800	490	1014	509	1000	675	WGTSV180049...
1800	590	1200	641	1200	739	WGTSV180059...
1800	690	1420	713	1500	804	WGTSV180069...
1800	790	1700	854	1800	886	WGTSV180079...

Tune VWS E



Barva je
zahrnuta v ceně



výběr připojení
v ceně

RADIÁTOR ELEKTRICKÝ (CENA VČETNĚ NÁPLNĚ A ZVOLENÉ TOPNÉ TYČE)

Připojení:

Výška [mm] 600:



Výška [mm] 1800:



A ↕ [mm]	B ↔ [mm]	Výkon [W]	MEG Cena bez DPH [EUR]	MOA/DRY/ TDY Cena bez DPH [EUR] (MOAIR: +12 EUR) (MOA BLUE: +38 EUR)	ONE Cena bez DPH [EUR] (Nezabudovaná, v 8cm profilu v barvě radiátoru)	REG 2 Cena bez DPH [EUR]	REG 3 Cena bez DPH [EUR]	SIM Cena bez DPH [EUR]	Terma Split třída I Cena bez DPH [EUR] (nezapomeňte si koupit regulátor KTX)	Smart Split třída I Cena bez DPH [EUR] (nezapomeňte si koupit SMART Wi-Fi regulátor VEO)	Kód produktu ... Kód konfigurace s. 366
600	590	400	608	616	635	586	596	576	562	562	WLTSV060059...
600	790	600	688	696	715	666	676	656	641	641	WLTSV060079...
600	990	800	769	777	796	747	757	737	723	723	WLTSV060099...
600	1190	1000	866	874	894	844	854	834	820	820	WLTSV060119...
600	1390	1000	946	954	973	924	934	914	900	900	WLTSV060139...
600	1590	1200	1028	1035	–	1005	1015	996	–	981	WLTSV060159...
1800	290	600	591	598	618	569	579	559	544	544	WLTSV180029...
1800	390	800	686	693	713	664	674	654	639	639	WLTSV180039...
1800	490	1000	769	777	796	747	757	737	723	723	WLTSV180049...
1800	590	1200	834	841	861	812	822	802	–	787	WLTSV180059...
1800	690	1500	–	–	–	–	–	866	–	852	WLTSV180069...
1800	790	1800	–	–	–	–	–	–	–	934	WLTSV180079...

DOPORUČUJEME PRO PŘIPOJENÍ ZX, Z1 i Z8:



Integrovaná sada termostatická, Chrom

 WRZT5G1-CR: 145 EUR

 WRZT5G2-CR: 145 EUR

Stránka: 296



Sada krycí integrovaná, Chrom

TGPCR002: 38 EUR

Stránka: 338



Háček bodový YO!

WRWYOY001*: 4 EUR

Stránka: 280



Topná tyč KTX4 BLUE, Chrom

WEK4B*: 137 EUR

Stránka: 252



RADIÁTOR VODNÍ / VODNĚ-ELEKTRICKÝ (DOKOUPIT TOPNOU TYČ)

Připojení:



A ↑ [mm]	B ↔ [mm]	75/65/20°C [W]	55/45/20°C [W]	 [W]	Barvy RAL a speciální barvy Cena bez DPH [EUR]	Kód produktu ... Kód konfigurace s. 363
820	440	533	288	600	295	WGTYT082044...
820	540	645	348	600	317	WGTYT082054...
820	640	755	407	800	333	WGTYT082064...
1020	440	666	358	600	339	WGTYT102044...
1020	540	806	433	800	361	WGTYT102054...
1020	640	943	507	1000	387	WGTYT102064...
1260	440	828	444	800	387	WGTYT126044...
1260	540	1002	537	1000	415	WGTYT126054...
1260	640	1173	628	1200	447	WGTYT126064...
1420	440	930	497	1000	415	WGTYT142044...
1420	540	1126	602	1200	442	WGTYT142054...
1420	640	1317	704	1200	480	WGTYT142064...
1780	440	1167	623	1200	474	WGTYT178044...
1780	540	1412	753	1500	512	WGTYT178054...
1780	640	1652	881	1500	550	WGTYT178064...

RADIÁTOR ELEKTRICKÝ (CENA VČETNĚ NÁPLNĚ A ZVOLENÉ TOPNÉ TYČE)

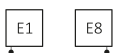

A ↕ [mm]	B ↔ [mm]	Výkon [W]	MEG Cena bez DPH [EUR]	MOA/DRY/TDY Cena bez DPH [EUR] (MOAIR: +12 EUR) (MOABLU: +38 EUR)	ONE Cena bez DPH [EUR] (Nezabudovaná, v 8cm profilu v barvě radiátoru)	REG 2 Cena bez DPH [EUR]	REG 3 Cena bez DPH [EUR]	SIM Cena bez DPH [EUR]	Terma Split třída I Cena bez DPH [EUR] (nezapomeňte si koupit regulátor KTX)	Smart Split třída I Cena bez DPH [EUR] (nezapomeňte si koupit SMART Wi-Fi regulátor VEO)	Kód produktu ... Kód konfigurace s. 366
820	440	600	389	397	416	367	377	357	343	343	WLTYT082044...
820	540	600	412	419	439	389	399	380	365	365	WLTYT082054...
820	640	800	427	435	455	405	415	396	381	381	WLTYT082064...
1020	440	600	434	441	461	412	421	402	387	387	WLTYT102044...
1020	540	800	455	462	482	432	442	423	408	408	WLTYT102054...
1020	640	1000	482	489	509	459	469	450	435	435	WLTYT102064...
1260	440	800	482	489	509	459	469	450	435	435	WLTYT126044...
1260	540	1000	510	517	537	488	498	478	463	463	WLTYT126054...
1260	640	1200	542	549	–	520	530	510	–	495	WLTYT126064...
1420	440	1000	510	517	537	488	498	478	463	463	WLTYT142044...
1420	540	1200	537	544	–	515	525	505	–	490	WLTYT142054...
1420	640	1200	575	582	–	553	563	543	–	528	WLTYT142064...
1780	440	1200	569	576	–	547	557	537	–	522	WLTYT178044...
1780	540	1500	–	–	–	–	–	575	–	560	WLTYT178054...
1780	640	1500	–	–	–	–	–	613	–	598	WLTYT178064...

Tytus One

   výběr připojení v ceně

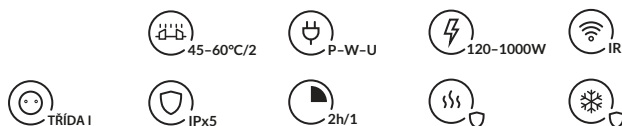

SADA OBSAHUJE:

Radiátor se zabudovanou topnou tyčí One. Funkce topné tyče ONE: Stránka 209.

DOPORUČUJEME PRO PŘIPOJENÍ S1 i S8:



Integrovaná sada termostatická s ponornou trubicí, Chrom

 WRZT5G5-CR: 151EUR
 WRZT5G6-CR: 151EUR
 Stránka: 298



Sada krycí integrovaná, Chrom
 TGPCR002: 38EUR
 Stránka: 338



Háček bodový YO!
 WRWYOY001*: 4EUR
 Stránka: 280



Regulátor TTIR1
 TGRBTBI001: 104EUR
 Stránka: 268



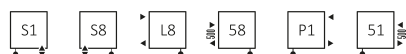

RADIÁTOR VODNĚ-ELEKTRICKÝ (CENA VČETNĚ ZABUDOVANÉ TOPNÉ TYČE ONE)

Připojení:

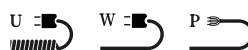

Vyber druh kabelu:



A ↕ [mm]	B ↔ [mm]	75/65/20°C [W]	55/45/20°C [W]	 [W]	Barvy RAL a speciální barvy Cena bez DPH [EUR]	Kód produktu ... Kód konfigurace s. 364
820	440	533	288	600	392	WZTYN082044...
820	540	645	348	600	414	WZTYN082054...
820	640	755	407	800	430	WZTYN082064...
1020	440	666	358	600	436	WZTYN102044...
1020	540	806	433	800	457	WZTYN102054...
1020	640	943	507	1000	484	WZTYN102064...
1260	440	828	444	800	484	WZTYN126044...
1260	540	1002	537	1000	512	WZTYN126054...
1420	440	930	497	1000	512	WZTYN142044...

Tytus One

RADIÁTOR ELEKTRICKÝ (CENA VČETNĚ NÁPLNĚ A ZABUDOVANÉ TOPNÉ TYČE ONE)

Připojení:



A ↕ [mm]	B ↔ [mm]	Výkon [W]	Barvy RAL a speciální barvy Cena bez DPH [EUR]	Kód produktu ... Kód konfigurace s. 365
820	440	600	410	WWTYN082044...
820	540	600	432	WWTYN082054...
820	640	800	448	WWTYN082064...
1020	440	600	455	WWTYN102044...
1020	540	800	475	WWTYN102054...
1020	640	1000	502	WWTYN102064...
1260	440	800	502	WWTYN126044...
1260	540	1000	531	WWTYN126054...
1420	440	1000	531	WWTYN142044...

Vipera



Barva je zahrnuta v ceně

výběr připojení v ceně

DOPORUČUJEME PRO PŘIPOJENÍ ZX, Z1 i Z8:



Integrovaná sada termostatická, Chrom

 WRZT5G1-CR: 145 EUR

 WRZT5G2-CR: 145 EUR

Stránka: 296



Sada krycí integrovaná, Chrom

TGPCR002: 38 EUR

Stránka: 338



Topná tyč MOA BLUE, Chrom

WEMOB01*: 142 EUR

Stránka: 257



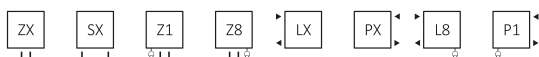

RADIÁTOR VODNÍ / VODNĚ-ELEKTRICKÝ (DOKOUPIT TOPNOU TYČ)

Připojení:

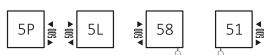

Výška [mm] 750÷1710:



A ↕ [mm]	B ↔ [mm]	75/65/20°C [W]	55/45/20°C [W]	 [W]	Barvy RAL a speciální barvy Cena bez DPH [EUR]	Kód produktu ... Kód konfigurace s. 363
510	400	165	90	200	211	WGVPA051040...
510	500	194	106	200	225	WGVPA051050...
510	600	223	122	200	232	WGVPA051060...
750	400	240	130	200	239	WGVPA075040...
750	500	263	143	300	257	WGVPA075050...
750	600	326	177	300	266	WGVPA075060...
990	400	315	170	300	269	WGVPA099040...
990	500	372	201	400	290	WGVPA099050...
990	600	428	231	400	302	WGVPA099060...
1230	400	386	208	400	298	WGVPA123040...
1230	500	456	245	400	323	WGVPA123050...
1230	600	525	283	600	336	WGVPA123060...
1470	400	462	248	400	329	WGVPA147040...
1470	500	546	293	600	356	WGVPA147050...
1470	600	629	337	600	372	WGVPA147060...
1710	400	537	287	600	359	WGVPA171040...
1710	500	634	339	600	389	WGVPA171050...
1710	600	730	391	800	408	WGVPA171060...



RADIÁTOR ELEKTRICKÝ (CENA VČETNĚ NÁPLNĚ A ZVOLENÉ TOPNÉ TYČE)

Připojení:



A ↕ [mm]	B ↔ [mm]	Výkon [W]	MEG Cena bez DPH [EUR]	MOA/DRY/ TDY Cena bez DPH [EUR] (MOAIR: +12 EUR) (MOABLUJ: +38 EUR)	ONE Cena bez DPH [EUR] (Nezabudovaná, v 8cm profilu v barvě radiátoru)	REG 2 Cena bez DPH [EUR]	REG 3 Cena bez DPH [EUR]	SIM Cena bez DPH [EUR]	Terma Split třída I Cena bez DPH [EUR] (nezapomeňte si koupit regulátor KTX)	Smart Split třída I Cena bez DPH [EUR] (nezapomeňte si koupit SMART Wi-Fi regulátor VEO)	Kód produktu ... Kód konfigurace s. 366
510	400	200	306	313	333	284	293	274	259	259	WLVPA051040...
510	500	200	319	327	346	297	307	287	273	273	WLVPA051050...
510	600	200	327	334	354	305	314	295	280	280	WLVPA051060...
750	400	200	334	341	361	312	322	302	287	287	WLVPA075040...
750	500	300	351	359	378	329	339	319	305	305	WLVPA075050...
750	600	300	361	368	388	339	349	329	314	314	WLVPA075060...
990	400	300	364	371	391	341	351	332	317	317	WLVPA099040...
990	500	400	384	392	412	362	372	352	338	338	WLVPA099050...
990	600	400	397	404	424	375	384	365	350	350	WLVPA099060...
1230	400	400	393	400	420	371	381	361	346	346	WLVPA123040...
1230	500	400	418	425	445	396	405	386	371	371	WLVPA123050...
1230	600	600	431	439	458	409	419	399	384	384	WLVPA123060...
1470	400	400	424	431	451	402	412	392	377	377	WLVPA147040...
1470	500	600	451	458	478	429	439	419	404	404	WLVPA147050...
1470	600	600	467	474	494	445	455	435	420	420	WLVPA147060...
1710	400	600	453	461	480	431	441	421	407	407	WLVPA171040...
1710	500	600	484	491	511	462	472	452	437	437	WLVPA171050...
1710	600	800	502	510	530	480	490	471	456	456	WLVPA171060...

Vipera One

 Barva je zahrnuta v ceně
  výběr připojení v ceně

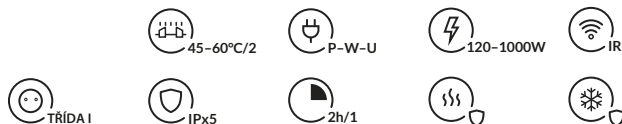

DOPORUČUJEME PRO PŘIPOJENÍ S1 i S8:



Integrovaná sada termostatická s ponornou trubící, Chrom

 WRZT5G5-CR: 151EUR

 WRZT5G6-CR: 151EUR

Stránka: 298



Sada krycí integrovaná, Chrom

TGPCR002: 38EUR

Stránka: 338



Regulátor TTIR1

TGRTBI001: 104EUR

Stránka: 268



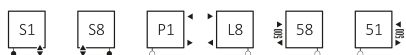

RADIÁTOR VODNĚ-ELEKTRICKÝ (CENA VČETNĚ ZABUDOVANÉ TOPNÉ TYČE ONE)

Připojení:

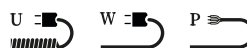

Vyber druh kabelu:



A ↑ [mm]	B ↔ [mm]	75/65/20°C [W]	55/45/20°C [W]	 [W]	Barvy RAL a speciální barvy Cena bez DPH [EUR]	Kód produktu ... Kód konfigurace s.364
750	400	240	130	200	336	WZVPN075040...
750	500	263	143	300	354	WZVPN075050...
750	600	326	177	300	364	WZVPN075060...
990	400	315	170	300	366	WZVPN099040...
990	500	372	201	400	387	WZVPN099050...
990	600	428	231	400	399	WZVPN099060...
1230	400	386	208	400	396	WZVPN123040...
1230	500	456	245	400	420	WZVPN123050...
1230	600	525	283	600	434	WZVPN123060...
1470	400	462	248	400	426	WZVPN147040...
1470	500	546	293	600	453	WZVPN147050...
1470	600	629	337	600	469	WZVPN147060...
1710	400	537	287	600	456	WZVPN171040...
1710	500	634	339	600	487	WZVPN171050...
1710	600	730	391	800	505	WZVPN171060...

Vipera One

RADIÁTOR ELEKTRICKÝ (CENA VČETNĚ NÁPLNĚ A ZABUDOVANÉ TOPNÉ TYČE ONE)

Připojení:



A ↕ [mm]	B ↔ [mm]	Výkon [W]	Barvy RAL a speciální barvy Cena bez DPH [EUR]	Kód produktu ... Kód konfigurace s. 365
750	400	200	355	WWVPN075040...
750	500	300	372	WWVPN075050...
750	600	300	382	WWVPN075060...
990	400	300	384	WWVPN099040...
990	500	400	405	WWVPN099050...
990	600	400	418	WWVPN099060...
1230	400	400	414	WWVPN123040...
1230	500	400	439	WWVPN123050...
1230	600	600	452	WWVPN123060...
1470	400	400	445	WWVPN147040...
1470	500	600	472	WWVPN147050...
1470	600	600	488	WWVPN147060...
1710	400	600	474	WWVPN171040...
1710	500	600	505	WWVPN171050...
1710	600	800	523	WWVPN171060...



Barva je zahrnuta v ceně



výběr připojení v ceně

DOPORUČUJEME PRO PŘIPOJENÍ SX:



Sada tříosová termostatická s možností montáže topné tyče skrz ventil, Chrom

WRZTCG4-CR: 147 EUR

WRZTCG5-CR: 147 EUR

Stránka: 295



Sada krycí dvojitá, Chrom

TGPCR001: 27 EUR

Stránka: 337



Háček HAPPY SHARK

300 mm - WRWH1A024: 66 EUR

400 mm - WRWH1A034: 66 EUR

500 mm - WRWH1A044: 66 EUR

600 mm - WRWH1A054: 66 EUR

Stránka: 283



Háček HAPPY RABBIT

300 mm - WRWH1B024: 66 EUR

400 mm - WRWH1B034: 66 EUR

500 mm - WRWH1B044: 66 EUR

600 mm - WRWH1B054: 66 EUR

Stránka: 283



RADIÁTOR VODNÍ / VODNĚ-ELEKTRICKÝ (DOKOUPIT TOPNOU TYČ)

Připojení:

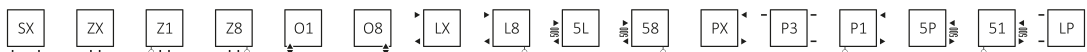

A ↕ [mm]	B ↔ [mm]	Barva ze vzorníku RAL a speciálních barev			Galvanický povrch Chrom			Barvy RAL a speciální barvy Cena bez DPH [EUR]	Chrom Cena bez DPH [EUR]	Kód produktu ... Kód konfigurace s.363
		75/65/20°C [W]	55/45/20°C [W]	[W]	75/65/20°C [W]	55/45/20°C [W]	[W]			
670	300	185	100	200	130	70	120	168	270	WGVOV067030...
670	400	230	124	200	161	87	200	178	306	WGVOV067040...
670	500	275	148	300	193	104	200	190	343	WGVOV067050...
670	600	320	172	300	224	120	200	205	380	WGVOV067060...
910	300	240	130	200	168	91	200	185	330	WGVOV091030...
910	400	295	159	300	207	111	200	198	377	WGVOV091040...
910	500	350	189	400	245	132	300	211	424	WGVOV091050...
910	600	405	218	400	284	153	300	231	475	WGVOV091060...
1150	300	300	162	300	210	113	200	204	391	WGVOV115030...
1150	400	366	197	400	256	138	300	218	447	WGVOV115040...
1150	500	433	233	400	303	163	300	234	509	WGVOV115050...
1150	600	501	269	600	351	188	400	257	566	WGVOV115060...
1390	300	356	192	400	249	134	300	222	451	WGVOV139030...
1390	400	434	234	400	304	164	300	237	517	WGVOV139040...
1390	500	512	275	600	358	193	400	257	590	WGVOV139050...
1390	600	590	316	600	413	221	400	282	661	WGVOV139060...
1630	300	414	223	400	290	156	300	239	506	WGVOV163030...
1630	400	503	270	600	352	189	400	258	593	WGVOV163040...
1630	500	592	318	600	414	223	400	279	675	WGVOV163050...
1630	600	681	365	800	477	256	400	309	757	WGVOV163060...

RADIÁTOR ELEKTRICKÝ (CENA VČETNĚ NÁPLNĚ A ZVOLENÉ TOPNÉ TYČE)

Připojení:



A ↕ [mm]	B ↔ [mm]	Výkon [W]		MEG		MOA/DRY/TDY		ONE		REG 2		REG 3		SIM		Terma Split třída I		Smart Split třída I		Kód produktu ... Kód konfigurace s. 366
				Cena bez DPH [EUR]		Cena bez DPH [EUR] (MOAIR: +12 EUR) (MOABLU: +38 EUR)		Cena bez DPH [EUR] (Nezabudovaná, v 8cm profilu v barvě radiátoru)		Cena bez DPH [EUR]		Cena bez DPH [EUR]		Cena bez DPH [EUR]		Cena bez DPH [EUR] (nezapomeňte si koupit regulátor KTX)		Cena bez DPH [EUR] (nezapomeňte si koupit SMART Wi-Fi regulátor VEO)		
		Barva	Chrom	Barvy RAL a speciální barvy	Chrom	Barvy RAL a speciální barvy	Chrom	Barvy RAL a speciální barvy	Chrom	Barvy RAL a speciální barvy	Chrom	Barvy RAL a speciální barvy	Chrom	Barvy RAL a speciální barvy	Chrom	Barvy RAL a speciální barvy	Chrom	Barvy RAL a speciální barvy	Chrom	
670	300	200	120	263	365	270	372	290	392	241	343	250	352	231	333	216	318	216	318	WLVOV067030...
670	400	200	200	273	400	280	408	300	427	250	378	260	388	241	368	226	354	226	354	WLVOV067040...
670	500	300	200	285	437	292	445	312	464	263	415	273	425	253	405	238	391	238	391	WLVOV067050...
670	600	300	200	300	474	307	482	327	501	277	452	287	462	268	442	253	427	253	427	WLVOV067060...
910	300	200	200	280	425	287	432	307	452	258	403	268	413	248	393	233	378	233	378	WLVOV091030...
910	400	300	200	292	472	300	479	319	499	270	450	280	459	260	440	246	425	246	425	WLVOV091040...
910	500	400	300	306	518	313	526	333	546	284	496	293	506	274	487	259	472	259	472	WLVOV091050...
910	600	400	300	325	570	333	577	352	597	303	548	313	558	293	538	279	523	279	523	WLVOV091060...
1150	300	300	200	298	485	306	493	325	512	276	463	286	473	266	453	252	439	252	439	WLVOV115030...
1150	400	400	300	312	542	319	549	339	569	290	520	300	530	280	510	265	495	265	495	WLVOV115040...
1150	500	400	300	329	603	336	611	356	630	307	581	317	591	297	571	282	557	282	557	WLVOV115050...
1150	600	600	400	351	660	359	667	378	687	329	638	339	648	319	628	305	613	305	613	WLVOV115060...
1390	300	400	300	316	546	323	553	343	573	293	523	303	533	284	514	269	499	269	499	WLVOV139030...
1390	400	400	300	332	612	339	619	359	639	309	590	319	600	300	580	285	565	285	565	WLVOV139040...
1390	500	600	400	351	684	359	692	378	712	329	662	339	672	319	653	305	638	305	638	WLVOV139050...
1390	600	600	400	377	756	384	763	404	783	355	734	365	743	345	724	330	709	330	709	WLVOV139060...
1630	300	400	300	334	601	341	608	361	628	312	579	322	589	302	569	287	554	287	554	WLVOV163030...
1630	400	600	400	352	688	360	696	380	715	330	666	340	676	321	656	306	641	306	641	WLVOV163040...
1630	500	600	400	373	769	381	777	400	796	351	747	361	757	341	737	327	723	327	723	WLVOV163050...
1630	600	800	400	403	852	410	859	430	879	381	830	391	839	371	820	356	805	356	805	WLVOV163060...

Vivo One



Barva je zahrnuta v ceně



výběr připojení v ceně



TŘÍDA I

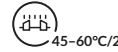

45-60°C/2



P-W-U



120-1000W



IR



IPx5



2h/1



IR

DOPORUČUJEME PRO PŘIPOJENÍ S1 i S8:



Integrovaná sada termos-
tatická s ponornou trubicí,
Chrom



WRZT5G5-CR: 151 EUR



WRZT5G6-CR: 151 EUR

Stránka: 298

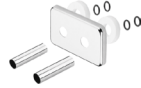

Sada krycí integrovaná,
Chrom

TGPCR002: 38 EUR

Stránka: 338



Háček HAPPY SHARK

300 mm - WRWH1A024: 66 EUR

400 mm - WRWH1A034: 66 EUR

500 mm - WRWH1A044: 66 EUR

600 mm - WRWH1A054: 66 EUR

Stránka: 283



Háček HAPPY RABBIT

300 mm - WRWH1B024: 66 EUR

400 mm - WRWH1B034: 66 EUR

500 mm - WRWH1B044: 66 EUR

600 mm - WRWH1B054: 66 EUR

Stránka: 283





RADIÁTOR VODNĚ-ELEKTRICKÝ (CENA VČETNĚ ZABUDOVANÉ TOPNÉ TYČE ONE)

Připojení:



Vyber druh kabelu:



A ↓ [mm]	B ↔ [mm]	Barva ze vzorníku RAL a speciálních barev			Galvanický povrch Chrom			Barvy RAL a speciální barvy <small>Cena bez DPH [EUR]</small>	Chrom <small>Cena bez DPH [EUR]</small>	Kód produktu <small>... Kód konfigurace s.364</small>
		75/65/20°C [W]	55/45/20°C [W]	 [W]	75/65/20°C [W]	55/45/20°C [W]	 [W]			
670	300	185	100	200	130	70	120	265	367	WZVON067030...
670	400	230	124	200	161	87	200	275	403	WZVON067040...
670	500	275	148	300	193	104	200	287	440	WZVON067050...
670	600	320	172	300	224	120	200	302	477	WZVON067060...
910	300	240	130	200	168	91	200	282	427	WZVON091030...
910	400	295	159	300	207	111	200	295	474	WZVON091040...
910	500	350	189	400	245	132	300	308	521	WZVON091050...
910	600	405	218	400	284	153	300	328	573	WZVON091060...
1150	300	300	162	300	210	113	200	301	488	WZVON115030...
1150	400	366	197	400	256	138	300	314	544	WZVON115040...
1150	500	433	233	400	303	163	300	332	606	WZVON115050...
1150	600	501	269	600	351	188	400	354	662	WZVON115060...
1390	300	356	192	400	249	134	300	318	548	WZVON139030...
1390	400	434	234	400	304	164	300	334	614	WZVON139040...
1390	500	512	275	600	358	193	400	354	687	WZVON139050...
1390	600	590	316	600	413	221	400	380	758	WZVON139060...
1630	300	414	223	400	290	156	300	336	603	WZVON163030...
1630	400	503	270	600	352	189	400	355	691	WZVON163040...
1630	500	592	318	600	414	223	400	376	772	WZVON163050...
1630	600	681	365	800	477	256	400	405	854	WZVON163060...

RADIÁTOR ELEKTRICKÝ (CENA VČETNĚ NÁPLNĚ A ZABUDOVANÉ TOPNÉ TYČE ONE)

Připojení:



A ↕ [mm]	B ↔ [mm]	Výkon [W]		Barvy RAL a speciální barvy Cena bez DPH [EUR]	Chrom Cena bez DPH [EUR]	Kód produktu ... Kód konfigurace s. 365
		Barva	Chrom			
670	300	200	120	284	386	WWWON067030...
670	400	200	200	293	421	WWWON067040...
670	500	300	200	306	458	WWWON067050...
670	600	300	200	321	495	WWWON067060...
910	300	200	200	301	446	WWWON091030...
910	400	300	200	313	493	WWWON091040...
910	500	400	300	327	539	WWWON091050...
910	600	400	300	346	591	WWWON091060...
1150	300	300	200	319	506	WWWON115030...
1150	400	400	300	333	563	WWWON115040...
1150	500	400	300	350	624	WWWON115050...
1150	600	600	400	372	681	WWWON115060...
1390	300	400	300	336	566	WWWON139030...
1390	400	400	300	352	633	WWWON139040...
1390	500	600	400	372	705	WWWON139050...
1390	600	600	400	398	777	WWWON139060...
1630	300	400	300	355	622	WWWON163030...
1630	400	600	400	373	709	WWWON163040...
1630	500	600	400	394	790	WWWON163050...
1630	600	800	400	424	873	WWWON163060...

Warp Room



Barva je zahrnuta v ceně

výběr připojení v ceně

DOPORUČUJEME PRO PŘIPOJENÍ ZX, YL, YP, Y2, Y7:



Integrovaná sada termostatická, Chrom

WRZT5G1-CR: 145 EUR

WRZT5G2-CR: 145 EUR

Stránka: 276



Sada krycí integrovaná, Chrom

TGPCR002: 38 EUR

Stránka: 318



RADIÁTOR VODNÍ / VODNĚ-ELEKTRICKÝ (DOKOUPIT TOPNOU TYČ)

Připojení:

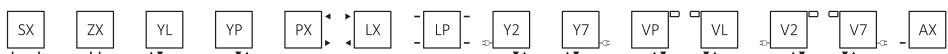

A ↓ [mm]	B ↔ [mm]	Barva ze vzorníku RAL a speciálních barev			Barvy RAL a speciální barvy Cena bez DPH [EUR]	Kód produktu ... Kód konfigurace s. 363
		75/65/20°C [W]	55/45/20°C [W]	 [W]		
330	525	324	167	300	297	WGWAR033052...
330	785	486	251	600	382	WGWAR033078...
330	1045	648	334	600	467	WGWAR033104...
330	1305	810	418	800	552	WGWAR033130...
330	1565	972	502	1000	637	WGWAR033156...
330	1825	1134	585	1200	722	WGWAR033182...
530	525	495	258	600	342	WGWAR053052...
530	785	743	388	800	449	WGWAR053078...
530	1045	990	516	1000	556	WGWAR053104...
530	1305	1238	646	1200	663	WGWAR053130...
530	1565	1486	775	1500	770	WGWAR053156...
530	1825	1733	904	1500	866	WGWAR053182...
630	525	578	303	600	363	WGWAR063052...
630	785	868	455	800	480	WGWAR063078...
630	1045	1157	607	1200	597	WGWAR063104...
630	1305	1446	758	1500	714	WGWAR063130...
630	1565	1735	910	1500	831	WGWAR063156...
630	1825	2024	1061	2000	948	WGWAR063182...
1200	395	779	410	-	473	WGWAR120039...
1200	525	1038	546	-	593	WGWAR120052...
1200	655	1298	683	-	713	WGWAR120065...
1600	395	1016	527	-	536	WGWAR160039...
1600	525	1355	703	-	666	WGWAR160052...
1600	655	1694	879	-	816	WGWAR160065...
1800	395	1135	585	-	568	WGWAR180039...
1800	525	1514	780	-	718	WGWAR180052...
1800	655	1892	975	-	880	WGWAR180065...

Warp Room E



Barva je zahrnuta v ceně



výběr připojení v ceně

RADIÁTOR ELEKTRICKÝ (CENA VČETNĚ NÁPLNĚ A ZVOLENÉ TOPNÉ TYČE)

Připojení:

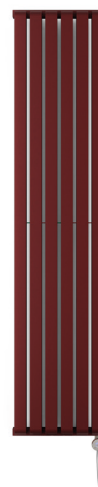

A ↕ [mm]	B ↔ [mm]	Výkon [W]	MEG Cena bez DPH [EUR]	MOA/DRY/ TDY Cena bez DPH [EUR] (MOA IR: +12 EUR) (MOA BLUE: +38 EUR)	ONE Cena bez DPH [EUR] (Nezabudovaná, v 8cm profilu v barvě radiátoru.)	REG 2 Cena bez DPH [EUR]	REG 3 Cena bez DPH [EUR]	SIM Cena bez DPH [EUR]	Terma Split třída I Cena bez DPH [EUR] (nezapomeňte si koupit regulátor KTX)	Smart Split třída I Cena bez DPH [EUR] (nezapomeňte si koupit SMARTWi-Fi regulátor VEO)	Kód produktu ... Kód konfigurace s. 366
330	525	300	392	399	419	370	380	360	345	345	WLWAR033052...
330	785	600	477	484	504	455	465	445	430	430	WLWAR033078...
330	1045	600	562	569	589	540	550	530	515	515	WLWAR033104...
330	1305	800	647	654	674	625	635	615	600	600	WLWAR033130...
330	1565	1000	732	739	759	710	720	700	685	685	WLWAR033156...
330	1825	1200	817	824	-	795	805	785	-	770	WLWAR033182...
530	525	600	437	444	464	415	425	405	390	390	WLWAR053052...
530	785	800	544	551	571	522	532	512	497	497	WLWAR053078...
530	1045	1000	651	658	678	629	639	619	604	604	WLWAR053104...
530	1305	1200	758	765	-	736	746	726	-	711	WLWAR053130...
530	1565	1500	-	-	-	-	-	833	-	818	WLWAR053156...
530	1825	1500	-	-	-	-	-	-	-	914	WLWAR053182...
630	525	600	458	465	485	436	446	426	411	411	WLWAR063052...
630	785	800	575	582	602	553	563	543	528	528	WLWAR063078...
630	1045	1200	692	699	-	670	680	660	-	645	WLWAR063104...
630	1305	1500	-	-	-	-	-	777	-	762	WLWAR063130...
630	1565	1500	-	-	-	-	-	894	-	879	WLWAR063156...
630	1825	2000	-	-	-	-	-	-	-	996	WLWAR063182...

Warp S



Barva je zahrnuta v ceně



výběr připojení v ceně

DOPORUČUJEME PRO PŘIPOJENÍ GD:



Sada komplexní integrovaný ventil s T- kusem s možností připojení topné tyče skrze ventil, Chrom

WRZT5G14-CR: 188EUR

WRZT5G15-CR: 188EUR

Stránka: 297



Sada krycí integrovaná, Chrom

TGPCR002: 38EUR

Stránka: 338



Topná tyč MOA, Chrom

WEMOA*: 105EUR

Stránka: 259



180°

RADIÁTOR VODNÍ / VODNĚ-ELEKTRICKÝ (DOKOUPIT TOPNOU TYČ)

Připojení:



A ↕ [mm]	B ↔ [mm]	75/65/20°C [W]	55/45/20°C [W]	 [W]	Barvy RAL a speciální barvy Cena bez DPH [EUR]	Kód produktu ... Kód konfigurace s. 363
655	500	450	241	400	281	WGWAS065050...
655	600	506	271	600	309	WGWAS065060...
785	500	551	297	600	341	WGWAS078050...
785	600	653	351	600	373	WGWAS078060...
915	500	643	346	600	379	WGWAS091050...
915	600	761	408	800	409	WGWAS091060...
1110	500	764	406	800	400	WGWAS111050...
1110	600	857	456	800	442	WGWAS111060...
1695	500	1167	620	1200	560	WGWAS169050...
1695	600	1310	696	1200	627	WGWAS169060...





RADIÁTOR ELEKTRICKÝ (CENA VČETNĚ NÁPLNĚ A ZVOLENÉ TOPNÉ TYČE)

Připojení:



A ↕ [mm]	B ↔ [mm]	Výkon [W]	MEG Cena bez DPH [EUR]	MOA/DRY/ TDY Cena bez DPH [EUR] (MOAIR: +12 EUR) (MOABLUE: +38 EUR)	ONE Cena bez DPH [EUR] (Nezabudovaná, v 8cm profilu v barvě radiátoru)	REG 2 Cena bez DPH [EUR]	REG 3 Cena bez DPH [EUR]	SIM Cena bez DPH [EUR]	Terma Split třída I Cena bez DPH [EUR] (nezapomeňte si koupit regulátor KTX)	Smart Split třída I Cena bez DPH [EUR] (nezapomeňte si koupit SMART WF-Fi regulátor VED)	Kód produktu ... Kód konfigurace s. 366
915	500	600	473	480	500	451	460	441	425	425	WLWAS091050...
915	600	800	503	510	529	481	490	470	455	455	WLWAS091060...
1110	500	800	495	502	522	473	483	463	448	448	WLWAS111050...
1110	600	800	537	544	564	515	525	505	490	490	WLWAS111060...
1695	500	1200	655	662	–	633	643	623	–	608	WLWAS169050...
1695	600	1200	721	729	–	699	709	689	–	674	WLWAS169060...

Warp T





 Barva je zahrnuta v ceně výběr připojení v ceně

DOPORUČUJEME PRO PŘIPOJENÍ ZX, Z1 i Z8:



Integrovaná sada termostatická,

Chrom

 WRZT5G1-CR: 145 EUR

 WRZT5G2-CR: 145 EUR

Stránka: 296



Sada krycí integrovaná, Chrom

TGPCR002: 38 EUR

Stránka: 338



Topná tyč KTX4 BLUE, Chrom

WEKT4*: 129 EUR

Stránka: 252



RADIÁTOR VODNÍ / VODNĚ-ELEKTRICKÝ (DOKOUPIT TOPNOU TYČ)

Připojení:

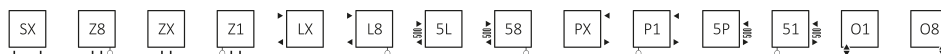

A ↕ [mm]	B ↔ [mm]	75/65/20°C [W]	55/45/20°C [W]	 [W]	Barvy RAL a speciální barvy Cena bez DPH [EUR]	Kód produktu ... Kód konfigurace s. 363
655	500	325	176	300	221	WGWT065050...
655	600	383	208	400	232	WGWT065060...
785	500	400	217	400	266	WGWT078050...
785	600	470	255	400	279	WGWT078060...
915	500	475	257	400	296	WGWT091050...
915	600	555	300	600	311	WGWT091060...
1110	500	553	298	600	305	WGWT111050...
1110	600	650	350	600	319	WGWT111060...
1695	500	846	453	800	410	WGWT169050...
1695	600	1000	535	1000	435	WGWT169060...

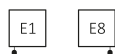

RADIÁTOR ELEKTRICKÝ (CENA VČETNĚ NÁPLNĚ A ZVOLENÉ TOPNÉ TYČE)

Připojení:



A ↕ [mm]	B ↔ [mm]	Výkon [W]	MEG Cena bez DPH [EUR]	MOA/DRY/ TDY Cena bez DPH [EUR] (MOA IR: +12 EUR) (MOA BLUE: +38 EUR)	ONE Cena bez DPH [EUR] (Nezabudovaná, v 8cm profilu v barvě radiátoru)	REG 2 Cena bez DPH [EUR]	REG 3 Cena bez DPH [EUR]	SIM Cena bez DPH [EUR]	Terma Split třída I Cena bez DPH [EUR] (nezapomeňte si koupit regulátor KTX)	Smart Split třída I Cena bez DPH [EUR] (nezapomeňte si koupit SMART Wi-Fi regulátor VEO)	Kód produktu ... Kód konfigurace s. 366
655	500	300	316	323	343	293	303	284	269	269	WLWAT065050...
655	600	400	327	334	354	305	314	295	280	280	WLWAT065060...
785	500	400	360	367	387	338	347	327	312	312	WLWAT078050...
785	600	400	373	380	400	351	360	340	325	325	WLWAT078060...
915	500	400	390	397	417	368	377	357	342	342	WLWAT091050...
915	600	600	405	412	432	383	393	373	358	358	WLWAT091060...
1110	500	600	399	407	426	377	387	367	352	352	WLWAT111050...
1110	600	600	414	421	441	392	402	382	367	367	WLWAT111060...
1695	500	800	506	514	533	484	494	474	459	459	WLWAT169050...
1695	600	1000	530	537	557	507	517	498	483	483	WLWAT169060...

Warp T One

  Barva je zahrnuta v ceně výběr připojení v ceně

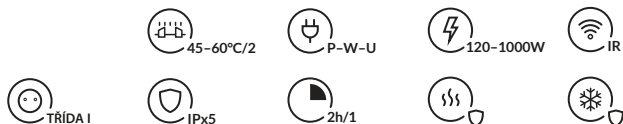

SADA OBSAHUJE:

Radiátor se zabudovanou topnou tyčičí One. Funkce topné tyče ONE: Stránka 205.

DOPORUČUJEME PRO PŘIPOJENÍ S1 i S8:



Integrovaná sada termostatická s ponornou trubčičí, Chrom

 WRZT5G5-CR: 151EUR

 WRZT5G6-CR: 151EUR

Stránka: 298



Sada krycí integrovaná, Chrom

TGPCR002: 38EUR

Stránka: 338



Regulátor TTIR1

TGRTBI001: 104EUR

Stránka: 268.



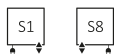

RADIÁTOR VODNĚ-ELEKTRICKÝ (CENA VČETNĚ ZABUDOVANÉ TOPNÉ TYČE ONE)

Připojení:

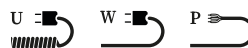

Vyber druh kabelu:



A ↕ [mm]	B ↔ [mm]	75/65/20°C [W]	55/45/20°C [W]	 [W]	Barvy RAL a speciální barvy Cena bez DPH [EUR]	Kód produktu ... Kód konfigurace s. 364
655	500	325	176	300	318	WZWTN065050...
655	600	383	208	400	329	WZWTN065060...
785	500	400	217	400	-	WZWTN078050...
785	600	470	254	400	376	WZWTN078060...
915	500	475	257	400	393	WZWTN091050...
915	600	555	300	600	409	WZWTN091060...
1110	500	553	298	600	402	WZWTN111050...
1110	600	650	350	600	416	WZWTN111060...
1695	500	846	453	800	509	WZWTN169050...
1695	600	1000	535	1000	532	WZWTN169060...

RADIÁTOR ELEKTRICKÝ (CENA VČETNĚ NÁPLNĚ A ZABUDOVANÉ TOPNÉ TYČE ONE)

Připojení:



Vyber druh kabelu:

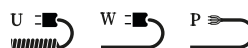

A ↕ [mm]	B ↔ [mm]	Výkon [W]	Barvy RAL a speciální barvy Cena bez DPH [EUR]	Kód produktu ... Kód konfigurace s. 365
785	500	400	381	WWWWTN078050...
785	600	400	394	WWWWTN078060...
915	500	400	411	WWWWTN091050...
915	600	600	426	WWWWTN091050...
1110	500	600	420	WWWWTN111050...
1110	600	600	435	WWWWTN111060...
1695	500	800	527	WWWWTN169050...
1695	600	1000	550	WWWWTN169060...

Warp T Bold



Barva je zahrnuta v ceně

výběr připojení v ceně

DOPORUČUJEME PRO PŘIPOJENÍ ZX, Z1 i Z8:



Integrovaná sada termostatická,

Chrom

WRZT5G1-CR: 145 EUR

WRZT5G2-CR: 145 EUR

Stránka: 296



Sada krycí integrovaná, Chrom

TGPCR002: 38 EUR

Stránka: 338



Topná tyč KTX4, Chrom

WEKT4*: 102 EUR

Stránka: 253



RADIÁTOR VODNÍ / VODNĚ-ELEKTRICKÝ (DOKOUPIT TOPNOU TYČ)

Připojení:



A ↕ [mm]	B ↔ [mm]	75/65/20°C [W]	55/45/20°C [W]	[W]	Barvy RAL a speciální barvy Cena bez DPH [EUR]	Kód produktu ... Kód konfigurace s. 363
655	500	460	249	400	263	WGWTB065050...
655	600	545	294	600	284	WGWTB065060...
785	500	551	297	600	304	WGWTB078050...
785	600	663	351	600	332	WGWTB078060...
915	500	643	346	600	354	WGWTB091050...
915	600	761	408	800	384	WGWTB091060...
1110	500	780	419	800	377	WGWTB111050...
1110	600	924	491	1000	405	WGWTB111060...
1695	500	1190	636	1200	523	WGWTB169050...
1695	600	1410	746	1500	570	WGWTB169060...









RADIÁTOR ELEKTRICKÝ (CENA VČETNĚ NÁPLNĚ A ZVOLENÉ TOPNÉ TYČE)

Připojení:



A ↕ [mm]	B ↔ [mm]	Výkon [W]	MEG Cena bez DPH [EUR]	MOA/DRY/ TDY Cena bez DPH [EUR] (MOA IR: +12 EUR) (MOA BLUE: +38 EUR)	ONE Cena bez DPH [EUR] (Nezabudovaná, v 8cm profilu v barvě radiátoru)	REG 2 Cena bez DPH [EUR]	REG 3 Cena bez DPH [EUR]	SIM Cena bez DPH [EUR]	Terma Split třída I Cena bez DPH [EUR] (nezapomeňte si koupit regulátor KTX)	Smart Split třída I Cena bez DPH [EUR] (nezapomeňte si koupit regulátor SMART Wi-Fi regulátor VEO)	Kód produktu ... Kód konfigurace s. 366
655	500	400	357	365	384	335	345	325	311	311	WLWTB065050...
655	600	600	377	384	404	355	365	345	330	330	WLWTB065060...
785	500	600	397	404	424	375	385	365	350	350	WLWTB078050...
785	600	800	426	433	452	404	413	393	378	378	WLWTB078060...
915	500	800	448	455	475	426	435	416	401	401	WLWTB091050...
915	600	800	478	485	504	456	465	445	430	430	WLWTB091060...
1110	500	800	472	479	499	450	459	440	425	425	WLWTB111050...
1110	600	1000	500	507	527	478	488	468	453	453	WLWTB111060...
1695	500	1200	618	625	-	596	606	586	-	571	WLWTB169050...
1695	600	1500	-	-	-	-	-	633	-	618	WLWTB169060...

Warp T Bold One

 Barva je zahrnuta v ceně
 

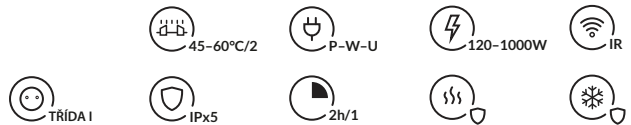







SADA OBSAHUJE:

Radiátor se zabudovanou topnou tyčicí One. Funkce topné tyče ONE: Stránka 209.

DOPORUČUJEME PRO PŘIPOJENÍ S1 i S8:



Integrovaná sada termostatická s ponornou trubící, Chrom

 WRZT5G5-CR: 151EUR

 WRZT5G6-CR: 151EUR

Stránka: 298



Sada krycí integrovaná, Chrom

TGPCR002: 38EUR

Stránka: 338



Regulátor TTIR1

TGRTBI001: 104EUR

Stránka: 268



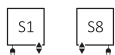

RADIÁTOR VODNĚ-ELEKTRICKÝ (CENA VČETNĚ ZABUDOVANÉ TOPNÉ TYČE ONE)

Připojení:

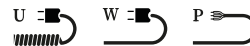

Vyber druh kabelu:



A ↕ [mm]	B ↔ [mm]	75/65/20°C [W]	55/45/20°C [W]	 [W]	Barvy RAL a speciální barvy Cena bez DPH [EUR]	Kód produktu ... Kód konfigurace s.364
655	500	460	249	400	360	WZWBN065050...
655	600	545	294	600	380	WZWBN065060...
785	500	563	303	600	401	WZWBN078060...
785	600	676	255	800	429	WZWBN078060...
915	500	667	358	800	452	WZWBN091060...
915	600	800	429	800	481	WZWBN091060...
1110	500	780	419	800	474	WZWBN111050...
1110	600	924	491	1000	502	WZWBN111060...

RADIÁTOR ELEKTRICKÝ (CENA VČETNĚ NÁPLNĚ A ZABUDOVANÉ TOPNÉ TYČE ONE)

Připojení:



Vyber druh kabelu:

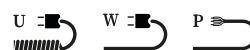

A ↕ [mm]	B ↔ [mm]	Výkon [W]	Barvy RAL a speciální barvy Cena bez DPH [EUR]	Kód produktu ... Kód konfigurace s.365
785	500	600	418	WWWBN078050...
785	600	800	447	WWWBN078050...
915	500	800	469	WWWBN915050...
915	600	800	499	WWWBN915050...
1110	500	800	493	WWWBN111050...
1110	600	1000	521	WWWBN111060...



Barva je zahrnuta v ceně

výběr připojení v ceně

DOPORUČUJEME PRO PŘIPOJENÍ ZX:



Integrovaná sada termostatická,
Chrom

 WRZT5G1-CR: 145 EUR

 WRZT5G2-CR: 145 EUR

Stránka: 296



Sada krycí integrovaná, Chrom

TGPCR002: 38 EUR

Stránka: 338

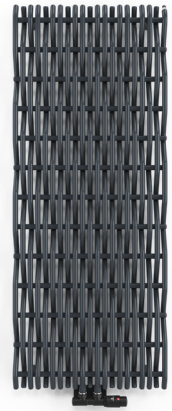

RADIÁTOR VODNÍ

Připojení:

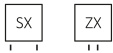

A ↑ [mm]	B ↔ [mm]	75/65/20°C [W]	55/45/20°C [W]	Barvy RAL a speciální barvy Cena bez DPH [EUR]	Kód produktu ... Kód konfigurace s. 363
1300	218	408	212	517	WGWIV130021
1300	368	681	353	653	WGWIV130036
1300	518	953	494	826	WGWIV130051
1300	668	1225	635	1 043	WGWIV130066
1600	218	503	257	568	WGWIV160021
1600	368	839	429	723	WGWIV160036
1600	518	1174	600	923	WGWIV160051
1600	668	1509	771	1 132	WGWIV160066
1900	218	617	315	619	WGWIV190021
1900	368	1028	525	792	WGWIV190036
1900	518	1439	735	1 019	WGWIV190051
1900	668	1850	945	1 257	WGWIV190066



Barva je zahrnuta v ceně

výběr připojení v ceně

DOPORUČUJEME PRO PŘIPOJENÍ Z1, Z8, ZX, Y1, Y8, YP, YL:



Integrovaná sada termostatická,

Chrom

WRZT5G1-CR: 145 EUR

WRZT5G2-CR: 145 EUR

Stránka: 296



Sada krycí integrovaná, Chrom

TGPCR002: 38 EUR

Stránka: 338



RADIÁTOR VODNÍ / VODNĚ-ELEKTRICKÝ (DOKOUPIT TOPNOU TYČ)

Připojení:

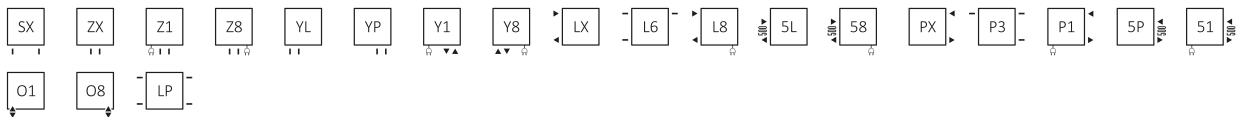

A ↓ [mm]	B ↔ [mm]	Barva ze vzorníku RAL a speciálních barev			Galvanický povrch Chrom			Barvy RAL a speciální barvy Cena bez DPH [EUR]	Chrom Cena bez DPH [EUR]	Kód produktu ... Kód konfigurace s. 363
		75/65/20°C [W]	55/45/20°C [W]	[W]	75/65/20°C [W]	55/45/20°C [W]	[W]			
600	500	248	134	300	174	94	200	301	443	WGZIG060050...
835	500	320	172	300	224	120	200	332	538	WGZIG083050...
1070	500	406	218	400	284	153	300	361	634	WGZIG107050...
1310	500	490	263	600	343	184	400	407	729	WGZIG131050...
1545	500	581	311	600	407	218	400	467	823	WGZIG154050...
1780	500	627	335	600	439	235	400	542	918	WGZIG178050...

RADIÁTOR ELEKTRICKÝ (CENA VČETNĚ NÁPLNĚ A ZVOLENÉ TOPNÉ TYČE)

Připojení:



A ↕ [mm]	B ↔ [mm]	Výkon [W]		MEG Cena bez DPH [EUR]		MOA/DRY/TDY Cena bez DPH [EUR] (MOAIR: +12 EUR) (MOABLUE: +38 EUR)		ONE Cena bez DPH [EUR] (Nezabudovaná, v 8cm profilu v barvě radiátoru)		REG 2 Cena bez DPH [EUR]		REG 3 Cena bez DPH [EUR]		SIM Cena bez DPH [EUR]		Terma Split třída I Cena bez DPH [EUR] (nezapomeňte si koupit regulátor KTX)		Smart Split třída I Cena bez DPH [EUR] (nezapomeňte si koupit SMART Wi-Fi regulátor VEO)		Kód produktu ... Kód konfigurace s. 366
				Barva	Chrom	Barvy RAL a speciální barvy	Chrom	Barvy RAL a speciální barvy	Chrom	Barvy RAL a speciální barvy	Chrom	Barvy RAL a speciální barvy	Chrom	Barvy RAL a speciální barvy	Chrom	Barvy RAL a speciální barvy	Chrom	Barvy RAL a speciální barvy	Chrom	
600	500	300	200	396	538	403	546	423	565	373	516	383	526	364	506	349	491	349	491	WLZIG060050...
835	500	300	200	426	633	434	640	453	660	404	611	414	621	394	601	380	586	380	586	WLZIG083050...
1070	500	400	300	456	729	463	736	483	756	434	707	443	716	424	697	409	682	409	682	WLZIG107050...
1310	500	600	400	501	823	509	831	528	850	479	801	489	811	469	791	455	777	455	777	WLZIG131050...
1545	500	600	400	562	918	569	925	589	945	539	896	549	906	530	886	515	871	515	871	WLZIG154050...
1780	500	600	400	637	1013	644	1020	664	1040	614	991	624	1000	605	981	590	966	590	966	WLZIG178050...

Příklad radiátoru Tytus One s designově zabudovanou topnou tyčí ONE

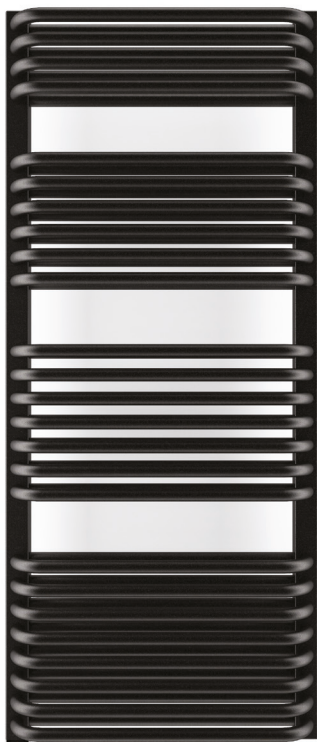

Rozložení teplot v elektrickém radiátoru s topnou tyčí

V elektrickém radiátoru s topným médiem je zdrojem tepla topná tyč, umístěná v jednom z kolektorů. Topný element umístěný v radiátoru zahřívá topné médium, čímž ho nutí cirkulovat v radiátoru. Molekuly zahřátého média, stoupají vzhůru a díky vlastním pohybům, se mísí s chladnými kapalinovými molekulami (takzvaným difúzním jevem) pohybují se a dál předávají teplo ve vodorovných trubkách radiátoru. O odevzdané teplo ochlazená kapalina klesá do spodních částí radiátoru tak, aby mohla po zahřátí znovu stoupat a předávat teplo v radiátoru (obrázek napravo).

Závěrem: Kolektor, ve kterém je umístěna topná tyč, bude vždy nejteplejším prvkem radiátoru (zejména jeho horní část) zatímco spodní trubky zůstanou chladnější. Tento jev je normální.

Poznámka: Pokud je topná tyč ONE zabudovaná skrytě přímo v kolektoru radiátoru (nikoli přes T- kus nebo ventil), zůstávají až 4 nejnižší radiátorové trubky chladné, protože používáme

dodatečnou ochranu topných prvků nebo regulátoru (mrtvá zóna topného tělesa). Získáme tak čistý design radiátoru, nenarušený vyčnívající topnou tyčí, na úkor obětování 4 spodních trubek, které budou chladné.

U elektrických radiátorů, které nejsou připojeny k vodním ÚT rozvodům, může díky vzduchovému polštáři ponechanému pro tepelnou roztažnost kapalného média a bezpečnost radiátoru zůstat horní profil chladný, zejména při nižších teplotních nastaveních zařízení. Proto ani u jiných radiátorů na trhu, které nejsou z výroby uzavřeny a vyžaduje se se u vodních např. doplnění destilované vody při úbytku média, neplňte až po napouštěcí otvory se zátkou. Radiátory od nás vyrobeny jako čistě elektrické jsou naplněny olejem a uzavřené, proto nevyžadují pravidelné doplňování.

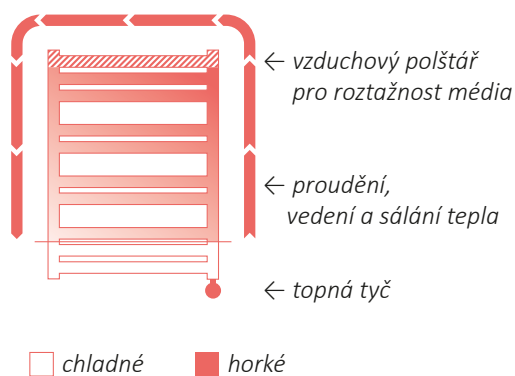

SMART WI-FI

Radiátor VOLTAN



Barva je zahrnuta v ceně



výběr připojení v ceně

ELEKTRICKÝ WI-FI PŘÍMOTOP



Připojení:

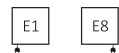

Vyber Druh kabelu:



APLIKACE PRO REGULOVÁNÍ TERMA SMART:



A ⇕	B ↔	 [W]	Váha [kg]	Cena bez DPH [EUR]	Kód produktu Kód konfigurace s. 350
500	660	1kW	8	330	WKVTN050066
500	1160	2kW	11	360	WKVTN050116

DOSTUPNÝ VE VŠECH BARVÁCH KROMĚ BLACK CROCODILE NEW A BAREV PREMIUM

Topná tyč Wi-Fi VEO



BAREVNÉ KOMBINACE

BARVA ČELNÍ PLOCHY A TĚLA:



OZDOBNÉ BOČNÍ KRYTŮ:



+ BARVY PREMIUM

PŘEHLED KONFIGURACÍ

REGULÁTOR BEZ TOPNÉHO ELEMENTU

Kód balení
Kód druhu kabelu
WE **VEO** **K** **WWX** **W**
Kód modelu
Kód barvy

APLIKACE PRO REGULOVÁNÍ TERMA SMART:



Model	Obal	Barva čelní plochy	Barva bočních krytů	Druh kabelu	Cena bez DPH [EUR]																																													
WE	VEO	K	<table border="0"> <tr><td>W</td><td>Bílá</td></tr> <tr><td>B</td><td>Černá</td></tr> </table>	W	Bílá	B	Černá	<table border="0"> <tr><td>WX</td><td>Bílá</td></tr> <tr><td>BX</td><td>Černá</td></tr> <tr><td>SX</td><td>Stříbrná</td></tr> <tr><td>CX</td><td>Chrom</td></tr> <tr><td>BGR</td><td>Bottle Green</td></tr> <tr><td>MDN</td><td>Midnight</td></tr> <tr><td>BBS</td><td>Brushed Brass</td></tr> <tr><td>BRA</td><td>Brass</td></tr> <tr><td>CPG</td><td>Champagne</td></tr> <tr><td>PER</td><td>Pers</td></tr> <tr><td>OBZ</td><td>Old Bronze</td></tr> <tr><td>TCG</td><td>True Copper Bright</td></tr> <tr><td>RWE</td><td>Red Wine</td></tr> <tr><td>RAW</td><td>Raw Metal</td></tr> <tr><td>MAV</td><td>Metal Alive</td></tr> <tr><td>SVR</td><td>Silver</td></tr> </table>	WX	Bílá	BX	Černá	SX	Stříbrná	CX	Chrom	BGR	Bottle Green	MDN	Midnight	BBS	Brushed Brass	BRA	Brass	CPG	Champagne	PER	Pers	OBZ	Old Bronze	TCG	True Copper Bright	RWE	Red Wine	RAW	Raw Metal	MAV	Metal Alive	SVR	Silver	<table border="0"> <tr><td>W</td><td>Rovný kabel se zástrčkou 1,5m</td></tr> <tr><td>P</td><td>Přímý kabel do zdi bez zástrčky 1,5m</td></tr> <tr><td>U</td><td>Kroucený kabel se zástrčkou 0,45m</td></tr> <tr><td>S</td><td>Bez kabelu (kabel ze zdi zapojit v krytce do svorkovnice tyče)</td></tr> </table>	W	Rovný kabel se zástrčkou 1,5m	P	Přímý kabel do zdi bez zástrčky 1,5m	U	Kroucený kabel se zástrčkou 0,45m	S	Bez kabelu (kabel ze zdi zapojit v krytce do svorkovnice tyče)	156
W	Bílá																																																	
B	Černá																																																	
WX	Bílá																																																	
BX	Černá																																																	
SX	Stříbrná																																																	
CX	Chrom																																																	
BGR	Bottle Green																																																	
MDN	Midnight																																																	
BBS	Brushed Brass																																																	
BRA	Brass																																																	
CPG	Champagne																																																	
PER	Pers																																																	
OBZ	Old Bronze																																																	
TCG	True Copper Bright																																																	
RWE	Red Wine																																																	
RAW	Raw Metal																																																	
MAV	Metal Alive																																																	
SVR	Silver																																																	
W	Rovný kabel se zástrčkou 1,5m																																																	
P	Přímý kabel do zdi bez zástrčky 1,5m																																																	
U	Kroucený kabel se zástrčkou 0,45m																																																	
S	Bez kabelu (kabel ze zdi zapojit v krytce do svorkovnice tyče)																																																	

DOPORUČUJEME:

Topný element SS1
WESS1*: 33 EUR

SS1: viz s. 216



Smart Split třída 1

Topný element SS1 a regulátory VEO tvoří 2 části kompletní topné tyče Wi-Fi VEO



Název	Výkon [W]	Cena bez DPH [EUR]	Kód produktu	Kód konfigurace
Smart Split třída 1	120	33	WESS101	K---D
Smart Split třída 1	200	33	WESS102	K---D
Smart Split třída 1	300	33	WESS103	K---D
Smart Split třída 1	400	33	WESS104	K---D
Smart Split třída 1	600	33	WESS106	K---D
Smart Split třída 1	800	33	WESS108	K---D
Smart Split třída 1	1000	33	WESS110	K---D
Smart Split třída 1	1500	33	WESS115	K---D
Smart Split třída 1	1800	33	WESS118	K---D
Smart Split třída 1	2000	33	WESS120	K---D

Termostatická hlavice Wi-Fi VAZ



BAREVNÉ KOMBINACE

BARVA ČELNÍ PLOCHY A TĚLA:



OZDOBNÉ BOČNÍ KRYTY:



+ BARVY PREMIUM



Termostatická hlavice Wi-Fi VAZ

PŘEHLED KONFIGURACÍ



APLIKACE PRO REGULOVÁNÍ TERMA SMART:



Model	Obal	Barva čelní plochy	Barva bočních krytů	Třída ochrany	Cena bez DPH [EUR]
WI VAZ	K Kartón	W B Bílá Černá	WX BX SX CX BGR MDN BBS BRA CPG PER OBZ TCG RWE RAW MAV SVR Bílá Černá Stříbrná Chrom Bottle Green Midnight Brushed Brass Brass Champagne Pers Old Bronze True Copper Bright Red Wine Raw Metal Metal Alive Silver	Třída I	145

ADAPTÉRY:



Adaptér pro termostatickou hlavici VAZ na ventil RAV



Adaptér pro termostatickou hlavici VAZ na ventil M28x1,5



Adaptér pro termostatickou hlavici VAZ na ventil RAVL



Adaptér pro termostatickou hlavici VAZ na ventil RA

Model	Barva	Cena bez DPH [EUR]	Kód produktu
RAV	Chrom	7	TGD003
M28	Chrom	7	TGD004
RAVL	Chrom	7	TGD002
RA	Chrom	7	TGD001

Senzor otevření okna Wi-Fi VOS



PŘEHLED KONFIGURACÍ:

Model	Barva	Cena bez DPH [EUR]	Kód produktu	Kód konfigurace
VOS	Bílá	75	WIVOS	K916
VOS	Stříbrná polomat	75	WIVOS	KSMA

Senzor teploty a vlhkosti Wi-Fi VTS



PŘEHLED KONFIGURACÍ:

Model	Barva	Cena bez DPH [EUR]	Kód produktu	Kód konfigurace
VTS	Bílá	77	WIVTS	K916
VTS	Stříbrná polomat	75	WIVTS	KSMA



SYSTÉM TERMA SMART WI-FI JE:

- inovační systém vytápění místností se samoučícím se algoritmem
- možnost individuálního rozšiřování systému Wi-Fi online regulace vytápění za pomoci 3 Wi-Fi zařízení a 2 Wi-Fi senzorů
- sada zjednoduší šetření energiemi, např. pomocí nastavení režimu vytápění, časového harmonogramu kdy má topit, nebo kontrolou otevření oken
- aktivně přizpůsobuje výkon vytápění venkovnímu počasí



- inteligentní snížení teploty prázdného domu a zvýšení, kdy se do domu vrací obyvatelé
- možnost online kontroly a nastavování systému přes Internet z celého světa
- funkce Child lock (Rodičovského zámku) na všech zařízeních
- Úspora: Není potřeba kupovat a instalovat Centrální řídicí jednotku s displejem. ovládáte přes svůj dotykový telefon.

Vše

Blower





BAREVNOST
BARVA VENTILÁTORU:



DRUHY KABELU:



PŘEHLED KONFIGURACÍ:

A ↕	B ↔	Hloubka G [mm]	Barva	Výkon  [W]	Váha  [kg]	Úchyty	Cena bez DPH [EUR]	Kód produktu	Kód konfigurace
239	400	95	bílá	1000	2,35	Kulaté a ploché	300	WEBL1	K916
239	400	95	šedá	1000	2,35	Kulaté a ploché	300	WEBL1	K906



ELEKTRICKÝ RADIÁTOR S VENTILÁTOREM

Připojení:

E8



PRODUKT SE SKLÁDÁ ZE 2 ČÁSTÍ

ČÁST 1 - ELEKTRICKÝ RADIÁTOR

Výška A ↕ [mm]	Šířka B ↔ [mm]	Výkon radiátoru s Blower [W]	Barvy RAL a speciální barvy Cena bez DPH [EUR]	Chrom Cena bez DPH [EUR]	Kód produktu
760	500	400	295	463	WLA8E076050
760	600	500	309	492	WLA8E076050
1140	500	600	345	608	WLA8E114050
1140	600	800	363	651	WLA8E114060
1580	500	800	391	753	WLA8E158050
1580	600	1000	412	811	WLA8E158060
1580	700	1000	436	835	WLA8E158070

ČÁST 2 - VENTILÁTOR BLOWER pro rychlé vyhřátí místnosti ([Stránka. 236](#))



ELEKTRICKÝ RADIÁTOR S VENTILÁTOREM

Připojení:

E8



PRODUKT SE SKLÁDÁ ZE 2 ČÁSTÍ

ČÁST 1 - ELEKTRICKÝ RADIÁTOR

Výška A ↕ [mm]	Šířka B ↔ [mm]	Výkon radiátoru s Blower [W]	Barvy RAL a speciální barvy Cena bez DPH [EUR]	Kód produktu
780	500	1000	402	WLC8T078050
780	600	1000	418	WLC8T078060
1050	500	1000	433	WLC8T105050
1050	600	1000	453	WLC8T105060
1320	500	1000	466	WLC8T132050
1320	600	1000	486	WLC8T132060
1590	500	1000	498	WLC8T159050
1590	600	1000	523	WLC8T159060
1860	500	1000	533	WLC8T186050

ČÁST 2 - VENTILÁTOR BLOWER pro rychlé vyhřátí místnosti ([Stránka. 236](#))

Fiona Blower



barvy
Premium

ELEKTRICKÝ RADIÁTOR S VENTILÁTOREM

Připojení:

E8

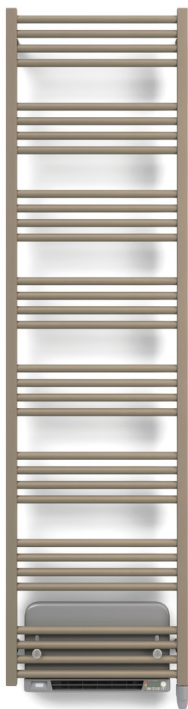

PRODUKT SE SKLÁDÁ ZE 2 ČÁSTÍ

ČÁST 1 - ELEKTRICKÝ RADIÁTOR

Výška A ↕ [mm]	Šířka B ↔ [mm]	Výkon radiátoru s Blower [W]	Barvy RAL a speciální barvy Cena bez DPH [EUR]	Chrom Cena bez DPH [EUR]	Kód produktu
1620	500	800	346	734	WLF8N162050
1620	600	800	359	808	WLF8N162060
1860	500	800	362	–	WLF8N186050
1860	600	1000	379	–	WLF8N186060

ČÁST 2 - VENTILÁTOR BLOWER pro rychlé vyhřátí místnosti (Stránka. 224)

Lima Blower



Barva je
zahrnuta v ceně



barvy
Premium

ELEKTRICKÝ RADIÁTOR S VENTILÁTOREM

Připojení:

E8



PRODUKT SE SKLÁDÁ ZE 2 ČÁSTÍ

ČÁST 1 - ELEKTRICKÝ RADIÁTOR

Výška A ↕ [mm]	Šířka B ↔ [mm]	Výkon radiátoru s Blower [W]	Barvy RAL a speciální barvy Cena bez DPH [EUR]	Chrom Cena bez DPH [EUR]	Kód produktu
820	500	400	287	–	WLL8M082050
820	600	400	299	595	WLL8M082060
820	700	600	315	626	WLL8M082070
1140	500	600	330	626	WLL8M114050
1140	600	800	345	656	WLL8M114060
1140	700	800	361	701	WLL8M114070
1460	500	800	345	685	WLL8M146050
1460	600	800	358	716	WLL8M146060
1460	700	1000	389	745	WLL8M146070
1700	500	800	386	745	WLL8M170050
1700	600	1000	412	806	WLL8M170060
1700	700	–	–	865	WLL8M170070

ČÁST 2 - VENTILÁTOR BLOWER pro rychlé vyhřátí místnosti (Stránka. 224)

Marlin Blower



ELEKTRICKÝ RADIÁTOR S VENTILÁTOREM

Připojení:

E8



PRODUKT SE SKLÁDÁ ZE 2 ČÁSTÍ

ČÁST 1 – ELEKTRICKÝ RADIÁTOR

Výška A ↕ [mm]	Šířka B ↔ [mm]	Výkon radiátoru s Blower [W]	Barvy RAL a speciální barvy Cena bez DPH [EUR]	Chrom Cena bez DPH [EUR]	Kód produktu
780	530	400	322	–	WLM8R078053
780	630	400	336	–	WLM8R078063
1185	530	600	370	657	WLM8R118053
1185	630	800	381	691	WLM8R118063
1680	530	800	461	806	WLM8R168053
1680	630	1000	481	858	WLM8R168063

ČÁST 2 - VENTILÁTOR BLOWER pro rychlé vyhřátí místnosti ([Stránka. 224](#))

Pola Blower



ELEKTRICKÝ RADIÁTOR S VENTILÁTOREM

Připojení:

E8

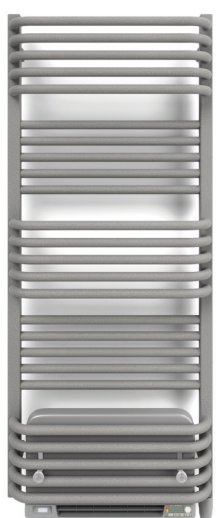

PRODUKT SE SKLÁDÁ ZE 2 ČÁSTÍ

ČÁST 1 – ELEKTRICKÝ RADIÁTOR

Výška A ↕ [mm]	Šířka B ↔ [mm]	Výkon radiátoru s Blower [W]	Barvy RAL a speciální barvy Cena bez DPH [EUR]	Chrom Cena bez DPH [EUR]	Kód produktu
1180	500	1000	335	731	WLP8L118050
1180	600	1000	352	776	WLP8L118060
1580	500	1000	372	977	WLP8L158050
1580	600	1000	407	1 038	WLP8L158060

ČÁST 2 - VENTILÁTOR BLOWER pro rychlé vyhřátí místnosti ([Stránka. 224](#))

Quadrus Bold Blower



Barva je zahrnuta v ceně

ELEKTRICKÝ RADIÁTOR S VENTILÁTOREM

Připojení:



PRODUKT SE SKLÁDÁ ZE 2 ČÁSTÍ

ČÁST 1 – ELEKTRICKÝ RADIÁTOR

Výška A ↕ [mm]	Šířka B ↔ [mm]	Výkon radiátoru s Blower [W]	Barvy RAL a speciální barvy Cena bez DPH [EUR]	Kód produktu
870	600	1000	508	WLQ8B087060
1185	500	1000	524	WLQ8B118050
1185	600	1000	574	WLQ8B118060

ČÁST 2 - VENTILÁTOR BLOWER pro rychlé vyhřátí místnosti ([Stránka. 224](#))

Quadrus Slim Blower



Barva je zahrnuta v ceně

ELEKTRICKÝ RADIÁTOR S VENTILÁTOREM

Připojení:

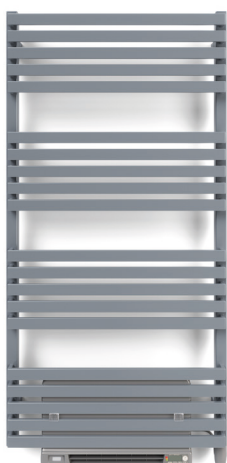

PRODUKT SE SKLÁDÁ ZE 2 ČÁSTÍ

ČÁST 1 – ELEKTRICKÝ RADIÁTOR

Výška A ↕ [mm]	Šířka B ↔ [mm]	Výkon radiátoru s Blower [W]	Barvy RAL a speciální barvy Cena bez DPH [EUR]	Kód produktu
870	450	1000	395	WLQ8S087050
870	600	1000	411	WLQ8S087060
1185	450	1000	428	WLQ8S118045
1185	600	1000	461	WLQ8S118060

ČÁST 2 - VENTILÁTOR BLOWER pro rychlé vyhřátí místnosti ([Stránka. 224](#))

Tytus Blower

ELEKTRICKÝ RADIÁTOR S VENTILÁTOREM

Připojení:

E8



PRODUKT SE SKLÁDÁ ZE 2 ČÁSTÍ

ČÁST 1 – ELEKTRICKÝ RADIÁTOR

Výška A ↕ [mm]	Šířka B ↔ [mm]	Výkon radiátoru s Blower [W]	Barvy RAL a speciální barvy Cena bez DPH [EUR]	Kód produktu
820	540	1000	401	WLT8T082054
820	640	1000	417	WLT8T082064
1020	540	1000	444	WLT8T102054
1020	640	1000	471	WLT8T102064
1260	540	1000	499	WLT8T126054

ČÁST 2 - VENTILÁTOR BLOWER pro rychlé vyhřátí místnosti ([Stránka. 224](#))

Warp T Blower Barva je zahrnuta v ceně

ELEKTRICKÝ RADIÁTOR S VENTILÁTOREM

Připojení:

E8



PRODUKT SE SKLÁDÁ ZE 2 ČÁSTÍ

ČÁST 1 – ELEKTRICKÝ RADIÁTOR

Výška A ↕ [mm]	Šířka B ↔ [mm]	Výkon radiátoru s Blower [W]	Barvy RAL a speciální barvy Cena bez DPH [EUR]	Kód produktu
785	500	1000	349	WLW8T078050
785	600	1000	362	WLW8T078060
915	500	1000	379	WLW8T091050
915	600	1000	395	WLW8T091060
1110	500	1000	389	WLW8T111050
1110	600	1000	404	WLW8T111060
1695	500	1000	496	WLW8T169050
1695	600	1000	519	WLW8T169060

ČÁST 2 - VENTILÁTOR BLOWER pro rychlé vyhřátí místnosti ([Stránka. 224](#))

Warp T Bold Blower



Barva je
zahrnuta v ceně

ELEKTRICKÝ RADIÁTOR S VENTILÁTOREM

Připojení:

E8



PRODUKT SE SKLÁDÁ ZE 2 ČÁSTÍ

ČÁST 1 - ELEKTRICKÝ RADIÁTOR

Výška A ⇕ [mm]	Šířka B ↔ [mm]	Výkon radiátoru s Blower [W]	Barvy RAL a speciální barvy Cena bez DPH [EUR]	Kód produktu
785	500	1000	387	WLW8B078050
785	600	1000	415	WLW8B078060
1110	500	1000	461	WLW8B111050
1110	600	1000	490	WLW8B111060

ČÁST 2 - VENTILÁTOR BLOWER pro rychlé vyhřátí místnosti ([Stránka. 224](#))

Elektrické topné tyče

Možnosti připojení topné tyče do radiátoru ÚT

Široká škála připojovacích otvorů v radiátorech TERMA umožňuje rozšířit funkce radiátoru ÚT i o topnou tyč. Tato kombinace přináší mnoho výhod. Především:

- K sušení mokrých oděvů, nebo jako sušák na ručníky, v i mimo topné období (např. v létě plavky). Pokud chcete šetřit své peníze, nastavte si na mnoha našich regulacích topných tyčí jednoduše čas sušení např. na 2h, což by mělo průměrně stačit k usušení ručníku.
- Schopnost ohřívat pokoj (např. koupelnu) během podzimních a jarních přechodů, aniž by musela běžet celá soustava ÚT, což u dálkového vytápění v bytech stejně nejde a radiátor ÚT s topnou tyčí nebo přímo jen radiátor s topnou tyčí označovaný jako „Elektrický radiátor“ je jedinou možností. U soustav vytápěných kotle, není potřeba spouštět pro krátkodobou tepelnou pohodu a udržovat celou soustavu předčasně a dusit kotel na minimální výkon jen pro přitápění.
- Většinou v projektech není koupelna dimenzovaná na tepelnou pohodu 24°C, proto je dobré si přitápět topným žebříkem.
- Pokud topný žebřík překryjete věcmi k usušení, ztratí po dobu zakrytí až 90% svého výkonu k vytápění prostoru. **PROTO VŽDY VOLTE VĚTŠÍ ROZMĚRY TOPNÝCH ŽEBŘÍKŮ S VĚTŠÍMI VÝKONY!**

Vše o instalacích a návodech k jednoduché obsluze topných tyčí se dočtete na stránkách www.termaheat.com. Doporučené metody instalace topné tyče do radiátoru jsou znázorněny v následujících výkresech.

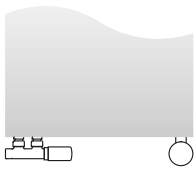

[Obrázek 1 - připojení topné tyče přímo do volného 1/2" otvoru. Radiátor na vodu ÚT připojen pomocí komplexního integrovaného termostatického ventilu] Připojení Z1, Z8, Y8, Y1

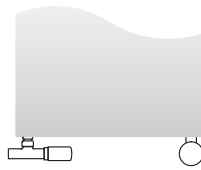

[Obr. 2 - připojení topné tyče přímo do volného 1/2" otvoru. Radiátor ÚT připojen pomocí komplexního integrovaného termostatického ventilu s ponornou trubicí] Připojení SX, S1, S8

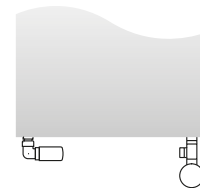

[Obrázek 3 - připojení topné tyče pomocí integrovaného uzavíracího ventilu s T-kusem] Připojení SX

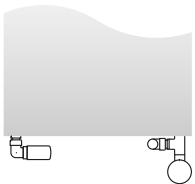

[Obr. 4 - připojení topné tyče pomocí T-kusu a uzavíracího ventilu] Připojení SX

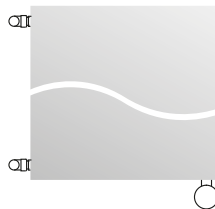

[Obr. 5 - připojení topné tyče přímo do radiátoru ÚT s bočním připojením k instalaci.] Připojení L8, P1, 58, 51

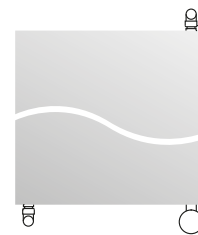

[Obr. 6 - připojení topné tyče přímo do radiátoru ÚT s protirohovým vstupem a výstupem topné vody] Připojení GD, UN, UC

Při použití topné tyče v radiátoru ÚT by jeden z ventilů měl zůstat vždy otevřený, což zabrání stoupání tlaku během provozu topné tyče a poškození radiátoru nebo topné tyče.

Topné tyče TERMA splňují všechny nezbytné požadavky evropských norem v oblasti bezpečnosti a ochrany uživatele před nebezpečím popálení. Z tohoto důvodu je důležité nedovolit, aby teplota vody vzrostla nad 82 ° C v topném okruhu s nainstalovaným radiátorem s topnou tyčí, protože by mohlo dojít k poškození tepelné pojistky v topné tyči.

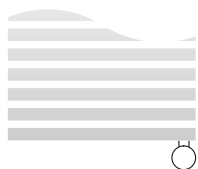

[Obr. 7 - připojení topné tyče zespodu do sloupku, kolmo na horizontální trubky radiátoru]
Připojení E1, E8, EX

Rozložení a hodnota teploty na povrchu elektrického radiátoru závisí na mnoha faktorech. Geometrie radiátoru je základní. Topná tyč by měl být vždy přišroubována ke spodní části radiátoru.

Topná tyč je prvek vyčnívající poza obrys radiátoru. Z tohoto důvodu je důležité pamatovat na správné umístění topné tyče tak, aby se minimalizovalo riziko mechanického poškození tělesa topné tyče (nestavějte na topné tyče nebo nevěšejte na ně žádné předměty).



[Obr. 8 - připojení topné tyče zespodu, rovnoběžně se svislými příčkami radiátoru]

Všechny čistě elektrické radiátory si můžete od společnosti TERMA zakoupit ve 2 variantách:

1. Sušák ručníků a oděvů nebo jako
2. Elektrický radiátor sloužící k vytápění místnosti. V tomto případě si zakupte topnou tyč i s týdenním regulátorem TTIR1 nebo zvolte tyč s aplikací do telefonu TERMA BlueLine, kde vhodným týdenním programem šetříte svou peněženku i životní prostředí.

Aplikace pro dálkové ovládání topných tyčí TERMA BlueLine - KTX4 BLUE a MOA BLUE

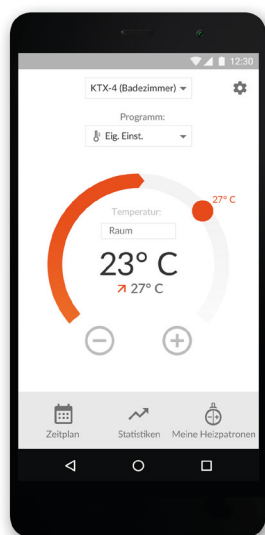

Funkce a výhody:

- Využívejte pokročilou technologii Bluetooth s nízkou spotřebou energie
- Užívejte si intuitivní nastavování a ovládání topných tyčí Terma BLUE Line
- K dispozici pro všechny mobilní zařízení s Android 4.0 a novější nebo iOS 6 a novější
- Spravujte více radiátorů s topnými tyčemi najednou
- Aplikace ekonomicky vyhodnotí rozdílné příkazy mezi více uživateli
- Tvořte a ukládejte si vlastní týdenní plány vytápění a libovolně mezi nimi přepínejte (např. týdenní plán pracovní týden, plán volný týden a týdenní plán dovolená)







K dispozici je ke stažení ovládací aplikace:



Elektrické topné tyče - vlastnosti a funkce

	SIM	REG 3	REG 2	MEG	MOA	MOA IR	
Typ regulátoru	Teplota topného tělesa	Teplota topného tělesa	Teplota topného tělesa / místnosti	Teplota topného tělesa	Teplota topného tělesa	Teplota topného tělesa / místnosti ^[1] ^[2]	
Nastavení teploty / mezistupně	65°C/1	50-65°C/2	65° C / 1	30-60° C /5	30-60° C /5	30-60° C /5	
Symetrický kryt (instalace na levé a pravé straně topného tělesa)	✓	✓	✓	✓	✓	✓	
Druhy kabelů (připojení)	P/R	P/W/U	P/W/T/R	W/M/U	W/M/U	W/M/U	
Třída ochrany zařízení	Třída I	Třída I	Třída I	Třída I	Třída I	Třída I	
Stupeň ochrany / krytí	IP67	IPx5	IPx5	IPx4	IPx5	IPx5	
Odnímatelný topný prvek (tyč ze 2ks) (Terma-Split System)	–	–	–	–	–	–	
Elektronický snímač teploty	–	–	–	✓	✓	✓	
Dostupný topný výkon	100-1500 [W]	120-1200 [W]	120-1200 [W]	120-1200 [W]	120-1200 [W]	120-1200 [W]	
Sušení ručníků max. v h / mezistupně	–	–	–	–	2h/-	2h/-	
Harmonogram denní	–	–	–	–	–	✓ ^[1]	
Harmonogram týdenní	–	–	–	–	–	✓ ^[2]	
Bezdrátový komunikační modul	–	–	–	–	–	IR	
Aktivní ochranu proti práci v suchém radiátoru	–	–	–	✓	✓	✓	
Počítadlo provozních hodin	–	–	–	–	–	–	
ANTIFREEZE chrání proti zamrznutí	–	–	–	✓	✓	✓	
Dvojitá ochrana proti přehřátí (přehřátí a ohněm)	✓	✓	✓	✓	✓	✓	
V souladu se směrnicemi EU 2009/125/WE a 2015/1188	–	–	–	–	–	✓ ^[2]	

Legenda:

-  P — Přímý kabel do zdi bez zástrčky 1,5m
-  R — Rovný kabel se zástrčkou a vypínačem
-  S — Bez kabelu (připojit kabel ze zdi v krytce do svorkovnice tyče)
-  T — Kroucený kabel se zástrčkou 0,45m a vypínačem
-  U — Kroucený kabel se zástrčkou 0,45m
-  W — Rovný kabel se zástrčkou 1,5m
-  M — Přímý kabel do zdi bez zástrčky 1,5m s krytem
- L — Bez kabelu (připojit kabel ze zdi v krytce do svorkovnice tyče pro SHERWOOD a TUNE)

	MOA Blue	DRY (TDY)	KTX 1	KTX 2	KTX 3	KTX 4	KTX 4 Blue	One	DTIR	TTIR
	Teplota topného tělesa / místnosti	Teplota topného tělesa	Tepelný výkon	Teplota topného tělesa.	Teplota topného tělesa	Teplota topného tělesa / místnosti ^{[1][2]}	Teplota místnosti /topného tělesa	Teplota topného tělesa / místnosti ^{[1][2]}	Teplota místnosti	
	15-30° C / 5 ^[4] 30-60° C / 5 ^[4]	48° C (42-60)	-/2 ^[3]	30-60° C / 5	30-60° C / 30	30-60° C / 5	15-30° C / 5 ^[4] 30-60° C / 5 ^[4]	45-60° C / 2	5-30° C	10-30° C
	✓	✓	✓	✓	✓	✓	✓	✓ ^[6]	–	
	W/M/U	W/M/U	P/W/U/S	P/W/U/S	P/W/U/S	P/W/U/S	P/W/U/S	P/W/U/M	–	
	Třída I	Třída I	Třída I	Třída I	Třída I	Třída I	Třída I	Třída I	Třída III	
	IPx5	IPx5	IPx4	IPx5 ^[7]	IPx5 ^[7]	IPx5 ^[7]	IPx5 ^[7]	IPx5	IP30	
	–	–	✓	✓	✓	✓	✓	–	–	
	✓	✓	✓	✓	✓	✓	✓	✓	✓	
	120-1000 [W]	120-1000 [W]	120-1000 [W]	120-1000 [W]	120-1000 [W]	120-1000 [W]	120-1000 [W]	120-1000 [W]	–	
	24h/48	5h/5 (3h/3)	–	2h/-	4h/8	4h/4	24h/48	2h/-	4h/16	4h/8
	✓	–	–	–	✓ ^[5]	✓ ^[1]	✓	✓ ^[2]	✓	–
	✓	–	–	–	–	✓ ^[2]	✓	✓ ^[2]	–	✓
	BLE	–	–	–	–	IR	BLE	IR	IR	IR
	✓	✓	–	–	✓	✓	✓	✓	–	
	–	–	–	–	–	✓	✓	–	–	
	✓	✓	✓	✓	✓	✓	✓	✓	✓	
	✓	✓	✓	✓	✓	✓	✓	✓	–	
	✓	–	–	–	–	✓ ^[2]	✓	✓ ^[2]	–	

1 Pouze pokud je topná tyč připojena k dálkovému Regulátoru DTIR1

2 Pouze pokud je topná tyč připojena k dálkovému Regulátoru TTIR1

3 Regulace výkonu topení 50/100

4 Aplikace pro ovládání Bluetooth umožňuje nastavit teplotu v krocích po 1°C.

5 Zjednodušené denní hodiny 4 časové zóny

6 Neplatí u lichoběžníkového a D profilu

7 Verze s připojením S ma IPx4



NOVINKA

Název	Výkon [W]	Bílá Cena bez DPH [EUR]	V barvě radiátoru Cena bez DPH [EUR]	Chrom Cena bez DPH [EUR]	Kód produktu ... Kód konfigurace
ONE D profil 30x40 levá	120	112	122	127	WEODL01...
ONE D profil 30x40 levá	200	112	122	127	WEODL02...
ONE D profil 30x40 levá	300	112	122	127	WEODL03...
ONE D profil 30x40 levá	400	112	122	127	WEODL04...
ONE D profil 30x40 levá	600	112	122	127	WEODL06...
ONE D profil 30x40 levá	800	112	122	127	WEODL08...
ONE D profil 30x40 levá	1000	112	122	127	WEODL10...
ONE D profil 30x40 pravá	120	112	122	127	WEODP01...
ONE D profil 30x40 pravá	200	112	122	127	WEODP02...
ONE D profil 30x40 pravá	300	112	122	127	WEODP03...
ONE D profil 30x40 pravá	400	112	122	127	WEODP04...
ONE D profil 30x40 pravá	600	112	122	127	WEODP06...
ONE D profil 30x40 pravá	800	112	122	127	WEODP08...
ONE D profil 30x40 pravá	1000	112	122	127	WEODP10...
ONE 30x30	120	112	122	127	WEOKX01...
ONE 30x30	200	112	122	127	WEOKX02...
ONE 30x30	300	112	122	127	WEOKX03...
ONE 30x30	400	112	122	127	WEOKX04...
ONE 30x30	600	112	122	127	WEOKX06...
ONE 30x30	800	112	122	127	WEOKX08...
ONE 30x30	1000	112	122	127	WEOKX10...
ONE 30x40	120	112	122	127	WEOPX01...
ONE 30x40	200	112	122	127	WEOPX02...
ONE 30x40	300	112	122	127	WEOPX03...
ONE 30x40	400	112	122	127	WEOPX04...
ONE 30x40	600	112	122	127	WEOPX06...
ONE 30x40	800	112	122	127	WEOPX08...
ONE 30x40	1000	112	122	127	WEOPX10...
ONE T 36x40 levá	120	112	122	127	WEOTL01...
ONE T 36x40 levá	200	112	122	127	WEOTL02...
ONE T 36x40 levá	300	112	122	127	WEOTL03...
ONE T 36x40 levá	400	112	122	127	WEOTL04...
ONE T 36x40 levá	600	112	122	127	WEOTL06...
ONE T 36x40 levá	800	112	122	127	WEOTL08...
ONE T 36x40 levá	1000	112	122	127	WEOTL10...
ONE T 36x40 pravá	120	112	122	127	WEOTP01...
ONE T 36x40 pravá	200	112	122	127	WEOTP02...
ONE T 36x40 pravá	300	112	122	127	WEOTP03...
ONE T 36x40 pravá	400	112	122	127	WEOTP04...
ONE T 36x40 pravá	600	112	122	127	WEOTP06...
ONE T 36x40 pravá	800	112	122	127	WEOTP08...
ONE T 36x40 pravá	1000	112	122	127	WEOTP10...
ONE kulatá R36	120	112	122	127	WEORX01...
ONE kulatá R36	200	112	122	127	WEORX02...
ONE kulatá R36	300	112	122	127	WEORX03...

Název	Výkon [W]	Bílá Cena bez DPH [EUR]	V barvě radiátoru Cena bez DPH [EUR]	Chrom Cena bez DPH [EUR]	Kód produktu ... Kód konfigurace
ONE kulatá R36	400	112	122	127	WEORX04...
ONE kulatá R36	600	112	122	127	WEORX06...
ONE kulatá R36	800	112	122	127	WEORX08...
ONE kulatá R36	1000	112	122	127	WEORX10...

PŘEHLED KONFIGURACÍ:



WE	Model Kód balení	Výkon [W]	Obal	Barva	Druh kabelu
	ODL ONE D levá	01 120	T Tuba	916 Bílá	W Rovný kabel se zástrčkou 1,5m P Přímý kabel do zdi bez zástrčky 1,5m U Kroucený kabel se zástrčkou 0,45m M Přímý kabel do zdi bez zástrčky 1,5m s krytem
	ODP ONE D pravá	02 200		CRO Chrom	
	OKX ONE 30x30	03 300		... nebo jiné ze vzorníku s. 14-16	
	OPX ONE 30x40	04 400			
	OTL ONE T levá	06 600			
	OTP ONE T pravá	08 800			
	ORX ONE R36	10 1000			

DOPORUČUJEME:



Regulátor DTIR1
TGRDSI001: 78 EUR
DTIR1: viz s. 269



Regulátor TTIR1
TGRBTI001: 104 EUR
TTIR1: viz s. 269

FUNKCE TOPNÉ TYČE ONE:



- Rozsah regulace teploty / počet stupňů nastavení



- Program týdenní

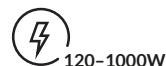

- Dostupný topný výkon



- Třída ochrany zařízení



- Aktivní ochrana proti práci v suchém radiátoru



- Program denní



- Elektronické čidlo teploty



- Způsoby připojení k el. proudu



- Modul bezdrátové komunikace



- Funkce Sušení / počet nastavení



- Stupeň ochrany opláštění



- Funkce antifreeze proti zamrznutí

KTX 4 BLUE



Název	Výkon [W]	Bílá Cena bez DPH [EUR]	Černá Cena bez DPH [EUR]	Stříbrná Cena bez DPH [EUR]	Chrom Cena bez DPH [EUR]	Kód produktu ... Kód konfigurace
KTX 4 BLUE Regulátor	–	123	131	131	137	WEK4B ...
KTX4 BLUE Regulátor + Terma Split třída I (TS1)	120 – 1000	148	154	154	161	WEK4B ...

PŘEHLED KONFIGURACÍ (ŘADA KTX TYČÍ SE SKLÁDÁ ZE 2 ČÁSTÍ - TOPNÉHO ELEMENTU TS1 A REGULÁTORU):

REGULÁTOR BEZ TOPNÉHO ELEMENTU

WE / K4B / K / SMA / W

Kód balení / *Kód barvy*
Kód modelu / *Kód druhu kabelu*

REGULÁTOR S TOPNÝM ELEMENTEM TS1

WE / K4B / 04 / T / SMA / W

Kód výkonu / *Kód barvy*
Kód modelu / *Kód balení* / *Kód druhu kabelu*

Model	Výkon [W]	Obal	Barva	Druh kabelu
WE K4B KTX4 BLUE	bez topného elementu	K Kartón	916 Bílá SMA Stříbrná CRO Chrom 905 Černá	W Rovný kabel se zástrčkou 1,5m P Přímý kabel do zdi bez zástrčky 1,5m U Kroucený kabel se zástrčkou 0,45m
WE K4B KTX4 BLUE	01 120 02 200 03 300 04 400 06 600 08 800 10 1000	T Tuba	916 Bílá SMA Stříbrná CRO Chrom 905 Černá	W Rovný kabel se zástrčkou 1,5m P Přímý kabel do zdi bez zástrčky 1,5m U Kroucený kabel se zástrčkou 0,45m

APLIKACE PRO DÁLKOVÉ OVLÁDÁNÍ
TERMA BLUE:





Všechny tyče TERMA vyrábíme s kabelem vycházejícím z tyče, jen u řady KTX s krytkou, kabel vyvést ze zdi a dopojit do KTX regulátoru a objednat v kódu kryt kabelu S

Název	Výkon [W]	Bílá Cena bez DPH [EUR]	Černá Cena bez DPH [EUR]	Stříbrná Cena bez DPH [EUR]	Chrom Cena bez DPH [EUR]	Zlatá Cena bez DPH [EUR]	Kód produktu ... Kód konfigurace
KTX 4 Regulátor	–	88	95	95	102	120	WEKT4 ...
KTX4 Regulátor + Terma Split třída I (TS1)	120 – 1000	113	121	121	129	147	WEKT4 ...

PŘEHLED KONFIGURACÍ (ŘADA KTX TYČÍ SE SKLÁDÁ ZE 2 ČÁSTÍ - TOPNÉHO ELEMENTU TS1 A REGULÁTORU):

REGULÁTOR BEZ TOPNÉHO ELEMENTU

Kód balení Kód barvy
WE/ **KT4** **K** **/SMA** **/W**
 Kód modelu Kód druhu kabelu

REGULÁTOR S TOPNÝM ELEMENTEM TS1

Kód výkonu Kód barvy
WE/ **KT4** **/04** **T** **/SMA** **/W**
 Kód modelu Kód balení Kód druhu kabelu

Model	Výkon [W]	Obal	Barva	Druh kabelu
WE KT4 KTX 4	bez topného elementu	K Kartón	916 Bílá	W Rovný kabel se zástrčkou 1,5m
			SMA Stříbrná	P Přímý kabel do zdi bez zástrčky 1,5m
			CRO Chrom	U Kroucený kabel se zástrčkou 0,45m
			905 Černá	S Bez kabelu (kabel ze zdi zapojit v krytce do svorkovnice tyče)
			GPO Zlatá	
WE KT4 KTX 4	01 120	T Tuba	916 Bílá	W Rovný kabel se zástrčkou 1,5m
	02 200		SMA Stříbrná	P Přímý kabel do zdi bez zástrčky 1,5m
	03 300		CRO Chrom	U Kroucený kabel se zástrčkou 0,45m
	04 400		905 Černá	S Bez kabelu (kabel ze zdi zapojit v krytce do svorkovnice tyče)
	06 600		GPO Zlatá	
	08 800			
	10 1000			

DOPORUČUJEME:

Regulátor DTIR1
TGRDSI001: 78 EUR



DTIR1: viz s. 269

Regulátor TTIR1
TGRBTI001: 104 EUR



TTIR1: viz s. 269

KTX 3



Všechny tyče TERMA vyrábíme s kabelem vycházejícím z tyče, jen u řady KTX s krytkou, kabel vyvěst ze zdi a dopojit do KTX regulátoru a objednat v kódu kryt kabelu S

Název	Výkon [W]	Bílá Cena bez DPH [EUR]	Černá Cena bez DPH [EUR]	Stříbrná Cena bez DPH [EUR]	Chrom Cena bez DPH [EUR]	Zlatá Cena bez DPH [EUR]	Kód produktu ... Kód konfigurace
KTX 3 Regulátor	–	88	95	95	102	120	WEKT3...
KTX 3 Regulátor + Terma Split třída I (TS1)	120 – 1000	113	121	121	129	147	WEKT3...

PŘEHLED KONFIGURACÍ (ŘADA KTX TYČÍ SE SKLÁDÁ ZE 2 ČÁSTÍ - TOPNÉHO ELEMENTU TS1 A REGULÁTORU): REGULÁTOR BEZ TOPNÉHO ELEMENTU

WE / KT3 / K / SMA / W

Kód modelu / Kód druhu kabelu / Kód balení / Kód barvy

REGULÁTOR S TOPNÝM ELEMENTEM TS1

WE / KT3 / 04 / T / SMA / W

Kód modelu / Kód výkonu / Kód balení / Kód druhu kabelu / Kód barvy

Model	Výkon [W]	Obal	Barva	Druh kabelu
WE KT3 KTX 3	bez topného elementu	K Kartón	916 Bílá SMA Stříbrná CRO Chrom 905 Černá GPO Zlatá	W Rovný kabel se zástrčkou 1,5m P Přímý kabel do zdi bez zástrčky 1,5m U Kroucený kabel se zástrčkou 0,45m S Bez kabelu (kabel ze zdi zapojit v krytce do svorkovnice tyče)
WE KT3 KTX 3	01 120 02 200 03 300 04 400 06 600 08 800 10 1000	T Tuba	916 Bílá SMA Stříbrná CRO Chrom 905 Černá GPO Zlatá	W Rovný kabel se zástrčkou 1,5m P Přímý kabel do zdi bez zástrčky 1,5m U Kroucený kabel se zástrčkou 0,45m S Bez kabelu (kabel ze zdi zapojit v krytce do svorkovnice tyče)

KTX 2



Všechny tyče TERMA vyrábíme s kabelem vycházejícím z tyče, jen u řady KTX s krytkou, kabel vyvstává ze zdi a dopojit do KTX regulátoru a objednat v kódu kryt kabelu S

Název	Výkon [W]	Bílá Cena bez DPH [EUR]	Černá Cena bez DPH [EUR]	Stříbrná Cena bez DPH [EUR]	Chrom Cena bez DPH [EUR]	Zlatá Cena bez DPH [EUR]	Kód produktu ... Kód konfigurace
KTX 2 Regulátor	–	75	81	81	85	102	WEKT2...
KTX 2 Regulátor + Terma Split třída I (TS1)	120 – 1000	102	107	107	112	129	WEKT2...

PŘEHLED KONFIGURACÍ (ŘADA KTX TYČÍ SE SKLÁDÁ ZE 2 ČÁSTÍ - TOPNÉHO ELEMENTU TS1 A REGULÁTORU):

REGULÁTOR BEZ TOPNÉHO ELEMENTU

WE / KT2 / K / SMA / W

Kód balení / Kód barvy
Kód modelu / Kód druhu kabelu

REGULÁTOR S TOPNÝM ELEMENTEM TS1

WE / KT2 / 04 / T / SMA / W

Kód výkonu / Kód barvy
Kód modelu / Kód balení / Kód druhu kabelu

Model	Výkon [W]	Obal	Barva	Druh kabelu
WE KT2 KTX 2	bez topného elementu	K Kartón	916 Bílá	W Rovný kabel se zástrčkou 1,5m
			SMA Stříbrná	P Přímý kabel do zdi bez zástrčky 1,5m
			CRO Chrom	U Kroucený kabel se zástrčkou 0,45m
			905 Černá	S Bez kabelu (kabel ze zdi zapojit v krytce do svorkovnice tyče)
			GPO Zlatá	
WE KT2 KTX 2	01 120	T Tuba	916 Bílá	W Rovný kabel se zástrčkou 1,5m
	02 200		SMA Stříbrná	P Přímý kabel do zdi bez zástrčky 1,5m
	03 300		CRO Chrom	U Kroucený kabel se zástrčkou 0,45m
	04 400		905 Černá	S Bez kabelu (kabel ze zdi zapojit v krytce do svorkovnice tyče)
	06 600		GPO Zlatá	
	08 800			
	10 1000			

KTX 1



Všechny tyče TERMA vyrábíme s kabelem vycházejícím z tyče, jen u řady KTX s krytkou, kabel vyvěst ze zdi a dopojit do KTX regulátoru a objednat v kódu kryt kabelu S

Název	Výkon [W]	Bílá Cena bez DPH [EUR]	Černá Cena bez DPH [EUR]	Stříbrná Cena bez DPH [EUR]	Chrom Cena bez DPH [EUR]	Zlatá Cena bez DPH [EUR]	Kód produktu ... Kód konfigurace
KTX 1 Regulátor	–	67	68	68	70	89	WEKT1 ...
KTX 1 Regulátor + Terma Split třída I (TS1)	120 – 1000	92	95	95	97	116	WEKT1 ...

PŘEHLED KONFIGURACÍ (ŘADA KTX TYČÍ SE SKLÁDÁ ZE 2 ČÁSTÍ - TOPNÉHO ELEMENTU TS1 A REGULÁTORU):

REGULÁTOR BEZ TOPNÉHO ELEMENTU

WE / KT1 K / SMA / W

Kód balení / Kód barvy / Kód modelu / Kód druhu kabelu

REGULÁTOR S TOPNÝM ELEMENTEM TS1

WE / KT1 04 / T / SMA / W

Kód výkonu / Kód barvy / Kód modelu / Kód balení / Kód druhu kabelu

Model	Výkon [W]	Obal	Barva	Druh kabelu
WE KT1 KTX 1	bez topného elementu	K Kartón	916 Bílá SMA Stříbrná CRO Chrom 905 Černá GPO Zlatá	W Rovný kabel se zástrčkou 1,5m P Přímý kabel do zdi bez zástrčky 1,5m U Kroucený kabel se zástrčkou 0,45m S Bez kabelu (kabel ze zdi zapojit v krytce do svorkovnice tyče)
WE KT1 KTX 1	01 120 02 200 03 300 04 400 06 600 08 800 10 1000	T Tuba	916 Bílá SMA Stříbrná CRO Chrom 905 Černá GPO Zlatá	W Rovný kabel se zástrčkou 1,5m P Přímý kabel do zdi bez zástrčky 1,5m U Kroucený kabel se zástrčkou 0,45m S Bez kabelu (kabel ze zdi zapojit v krytce do svorkovnice tyče)

MOA BLUE



Název	Výkon [W]	Bílá Cena bez DPH [EUR]	Černá Cena bez DPH [EUR]	Stříbrná Cena bez DPH [EUR]	Chrom Cena bez DPH [EUR]	Kód produktu ... Kód konfigurace
MOA BLUE	120	133	137	137	142	WEMOB01 ...
MOA BLUE	200	133	137	137	142	WEMOB02 ...
MOA BLUE	300	133	137	137	142	WEMOB03 ...
MOA BLUE	400	133	137	137	142	WEMOB04 ...
MOA BLUE	600	133	137	137	142	WEMOB06 ...
MOA BLUE	800	133	137	137	142	WEMOB08 ...
MOA BLUE	1000	133	137	137	142	WEMOB10 ...
MOA BLUE	1200	133	137	137	142	WEMOB12 ...
MOA BLUE + T- kus	120	137	142	142	147	WEMBT01 ...
MOA BLUE + T- kus	200	137	142	142	147	WEMBT02 ...
MOA BLUE + T- kus	300	137	142	142	147	WEMBT03 ...
MOA BLUE + T- kus	400	137	142	142	147	WEMBT04 ...
MOA BLUE + T- kus	600	137	142	142	147	WEMBT06 ...
MOA BLUE + T- kus	800	137	142	142	147	WEMBT08 ...
MOA BLUE + T- kus	1000	137	142	142	147	WEMBT10 ...
MOA BLUE + T- kus	1200	137	142	142	147	WEMBT12 ...

PŘEHLED KONFIGURACÍ:



APLIKACE PRO DÁLKOVÉ OVLÁDÁNÍ
TERMA BLUE:



Model	Výkon [W]	Obal	Barva	Druh kabelu
WE MOB MOA BLUE	01 120	F Fólie	916 Bílá	W Rovný kabel se zástrčkou 1,5m
WE MBT MOA BLUE + T- kus	02 200	T Tuba	SMA Stříbrná	M Přímý kabel do zdi bez zástrčky 1,5m s krytem
	03 300		CRO Chrom	U Kroucený kabel se zástrčkou 0,45m
	04 400		905 Černá	
	06 600			
	08 800			
	10 1000			
	12 1200			



Název	Výkon [W]	Bílá Cena bez DPH [EUR]	Černá Cena bez DPH [EUR]	Stříbrná Cena bez DPH [EUR]	Chrom Cena bez DPH [EUR]	Zlatá Cena bez DPH [EUR]	Kód produktu ... Kód konfigurace
MOA IR	120	105	110	110	117	129	WEMOR01...
MOA IR	200	105	110	110	117	129	WEMOR02...
MOA IR	300	105	110	110	117	129	WEMOR03...
MOA IR	400	105	110	110	117	129	WEMOR04...
MOA IR	600	105	110	110	117	129	WEMOR06...
MOA IR	800	105	110	110	117	129	WEMOR08...
MOA IR	1000	105	110	110	117	129	WEMOR10...
MOA IR	1200	105	110	110	117	129	WEMOR12...
MOA IR + T- kus	120	110	115	115	122	142	WEMRT01...
MOA IR + T- kus	200	110	115	115	122	142	WEMRT02...
MOA IR + T- kus	300	110	115	115	122	142	WEMRT03...
MOA IR + T- kus	400	110	115	115	122	142	WEMRT04...
MOA IR + T- kus	600	110	115	115	122	142	WEMRT06...
MOA IR + T- kus	800	110	115	115	122	142	WEMRT08...
MOA IR + T- kus	1000	110	115	115	122	142	WEMRT10...
MOA IR + T- kus	1200	110	115	115	122	142	WEMRT12...

PŘEHLED KONFIGURACÍ:



Model	Výkon [W]	Obal	Barva	Druh kabelu
WE MOR MOA IR	01 120	F fólie	916 Bílá	W Rovný kabel se zástrčkou 1,5m
MRT MOA IR + T- kus	02 200	T Tuba	SMA Stříbrná	M Přímý kabel do zdi bez zástrčky 1,5m s krytem
	03 300		CRO Chrom	U Kroucený kabel se zástrčkou 0,45m
	04 400		905 Černá	
	06 600		GPO Zlatá	
	08 800			
	10 1000			
	12 1200			

DOPORUČUJEME:

Regulátor DTIR1
TGRDSI001: 78 EUR

DTIR1: viz s. 269



Regulátor TTIR1
TGRBTI001: 104 EUR

TTIR1: viz s. 269



MOA



Název	Výkon [W]	Bílá Cena bez DPH [EUR]	Černá Cena bez DPH [EUR]	Stříbrná Cena bez DPH [EUR]	Chrom Cena bez DPH [EUR]	Zlatá Cena bez DPH [EUR]	Kód produktu ... Kód konfigurace
MOA	120	95	99	99	105	117	WEMOA01...
MOA	200	95	99	99	105	117	WEMOA02...
MOA	300	95	99	99	105	117	WEMOA03...
MOA	400	95	99	99	105	117	WEMOA 04...
MOA	600	95	99	99	105	117	WEMOA06...
MOA	800	95	99	99	105	117	WEMOA08...
MOA	1000	95	99	99	105	117	WEMOA10...
MOA	1200	95	99	99	105	117	WEMOA12...
MOA + T- kus	120	99	104	104	110	127	WEMAT01...
MOA + T- kus	200	99	104	104	110	127	WEMAT02...
MOA + T- kus	300	99	104	104	110	127	WEMAT03...
MOA + T- kus	400	99	104	104	110	127	WEMAT04...
MOA + T- kus	600	99	104	104	110	127	WEMAT06...
MOA + T- kus	800	99	104	104	110	127	WEMAT08...
MOA + T- kus	1000	99	104	104	110	127	WEMAT10...
MOA + T- kus	1200	99	104	104	110	127	WEMAT12...

PŘEHLED KONFIGURACÍ:

Kód výkonu
Kód barvy
Kód druhu kabelu
WE / MAT / 04 / T / SMA / W
Kód modelu
Kód balení

Model	Výkon [W]	Obal	Barva	Druh kabelu
WE MOA	MOA	F Fólie	916 Bílá	W Rovný kabel se zástrčkou 1,5m
MAT	MOA + T- kus	T Tuba	SMA Stříbrná	M Přímý kabel do zdi bez zástrčky 1,5m s krytem
	01 120		CRO Chrom	U Kroucený kabel se zástrčkou 0,45m
	02 200		905 Černá	
	03 300		GPO Zlatá	
	04 400			
	06 600			
	08 800			
	10 1000			
	12 1200			

DRY



Název	Výkon [W]	Bílá Cena bez DPH [EUR]	Černá Cena bez DPH [EUR]	Stříbrná Cena bez DPH [EUR]	Chrom Cena bez DPH [EUR]	Zlatá Cena bez DPH [EUR]	Kód produktu ... Kód konfigurace
DRY	120	95	99	99	105	117	WEDRY01...
DRY	200	95	99	99	105	117	WEDRY02...
DRY	300	95	99	99	105	117	WEDRY03...
DRY	400	95	99	99	105	117	WEDRY04...
DRY	600	95	99	99	105	117	WEDRY06...
DRY	800	95	99	99	105	117	WEDRY08...
DRY	1000	95	99	99	105	117	WEDRY10...
DRY	1200	95	99	99	105	117	WEDRY12...
DRY + T- kus	120	99	104	104	110	127	WEDYT01...
DRY + T- kus	200	99	104	104	110	127	WEDYT02...
DRY + T- kus	300	99	104	104	110	127	WEDYT03...
DRY + T- kus	400	99	104	104	110	127	WEDYT04...
DRY + T- kus	600	99	104	104	110	127	WEDYT06...
DRY + T- kus	800	99	104	104	110	127	WEDYT08...
DRY + T- kus	1000	99	104	104	110	127	WEDYT10...
DRY + T- kus	1200	99	104	104	110	127	WEDYT12...

PŘEHLED KONFIGURACÍ:



Model	Výkon [W]	Obal	Barva	Druh kabelu
WE DRY DRY	01 120	F fólie	916 Bílá	W Rovný kabel se zástrčkou 1,5m
DYT DRY + T- kus	02 200	T Tuba	SMA Stříbrná	M Příímý kabel do zdi bez zástrčky 1,5m s krytem
	03 300		CRO Chrom	U Kroucený kabel se zástrčkou 0,45m
	04 400		905 Černá	
	06 600		GPO Zlatá	
	08 800			
	10 1000			
	12 1200			



Název	Výkon [W]	Bílá Cena bez DPH [EUR]	Černá Cena bez DPH [EUR]	Stříbrná Cena bez DPH [EUR]	Chrom Cena bez DPH [EUR]	Zlatá Cena bez DPH [EUR]	Kód produktu ... Kód konfigurace
TDY	120	92	96	96	102	111	WETDY01...
TDY	200	92	96	96	102	111	WETDY02...
TDY	300	92	96	96	102	111	WETDY03...
TDY	400	92	96	96	102	111	WETDY04...
TDY	600	92	96	96	102	111	WETDY06...
TDY	800	92	96	96	102	111	WETDY08...
TDY	1000	92	96	96	102	111	WETDY10...
TDY	1200	92	96	96	102	111	WETDY12...
TDY + T- kus	120	96	101	101	107	121	WETYT01...
TDY + T- kus	200	96	101	101	107	121	WETYT02...
TDY + T- kus	300	96	101	101	107	121	WETYT03...
TDY + T- kus	400	96	101	101	107	121	WETYT04...
TDY + T- kus	600	96	101	101	107	121	WETYT06...
TDY + T- kus	800	96	101	101	107	121	WETYT08...
TDY + T- kus	1000	96	101	101	107	121	WETYT10...
TDY + T- kus	1200	96	101	101	107	121	WETYT12...

PŘEHLED KONFIGURACÍ:



Model	Výkon [W]	Obal	Barva	Druh kabelu
WE TDY TDY	01 120	F fólie	916 Bílá	W Rovný kabel se zástrčkou 1,5m
TYT TDY + T- kus	02 200	T Tuba	SMA Stříbrná	M Příímý kabel do zdi bez zástrčky 1,5m s krytem
	03 300		CRO Chrom	U Kroucený kabel se zástrčkou 0,45m
	04 400		905 Černá	
	06 600		GPO Zlatá	
	08 800			
	10 1000			
	12 1200			



Název	Výkon [W]	Bílá Cena bez DPH [EUR]	Černá Cena bez DPH [EUR]	Stříbrná Cena bez DPH [EUR]	Chrom Cena bez DPH [EUR]	Zlatá Cena bez DPH [EUR]	Kód produktu ... Kód konfigurace
MEG	120	90	92	92	97	108	WEMEG01...
MEG	200	90	92	92	97	108	WEMEG02...
MEG	300	90	92	92	97	108	WEMEG03...
MEG	400	90	92	92	97	108	WEMEG04...
MEG	600	90	92	92	97	108	WEMEG06...
MEG	800	90	92	92	97	108	WEMEG08...
MEG	1000	90	92	92	97	108	WEMEG10...
MEG	1200	90	92	92	97	108	WEMEG12...
MEG + T- kus	120	94	97	97	101	117	WEMGT01...
MEG + T- kus	200	94	97	97	101	117	WEMGT02...
MEG + T- kus	300	94	97	97	101	117	WEMGT03...
MEG + T- kus	400	94	97	97	101	117	WEMGT04...
MEG + T- kus	600	94	97	97	101	117	WEMGT06...
MEG + T- kus	800	94	97	97	101	117	WEMGT08...
MEG + T- kus	1000	94	97	97	101	117	WEMGT10...
MEG + T- kus	1200	94	97	97	101	117	WEMGT12...

PŘEHLED KONFIGURACÍ:

Kód výkonu
Kód druhu kabelu
WE / MEG / 04 / T SMA / W
Kód modelu
Kód balení
Kód barvy

Model	Výkon [W]	Obal	Barva	Druh kabelu
WE MEG MEG	01 120	F fólie	916 Bílá	W Rovný kabel se zástrčkou 1,5m
MGT MEG + T- kus	02 200	T Tuba	SMA Stříbrná	M Přímý kabel do zdi bez zástrčky 1,5m s krytem
	03 300		CRO Chrom	U Kroucený kabel se zástrčkou 0,45m
	04 400		905 Černá	
	06 600		GPO Zlatá	
	08 800			
	10 1000			
	12 1200			

REG 3



Název	Výkon [W]	Bílá Cena bez DPH [EUR]	Černá Cena bez DPH [EUR]	Stříbrná Cena bez DPH [EUR]	Chrom Cena bez DPH [EUR]	Kód produktu ... Kód konfigurace
REG 3	120	78	81	81	84	WER3G01...
REG 3	200	78	81	81	84	WER3G02...
REG 3	300	78	81	81	84	WER3G03...
REG 3	400	78	81	81	84	WER3G04...
REG 3	600	78	81	81	84	WER3G06...
REG 3	800	78	81	81	84	WER3G08...
REG 3	1000	78	81	81	84	WER3G10...
REG 3	1200	78	81	81	84	WER3G12...
REG 3 + T- kus	120	83	85	85	88	WER3T01...
REG 3 + T- kus	200	83	85	85	88	WER3T02...
REG 3 + T- kus	300	83	85	85	88	WER3T03...
REG 3 + T- kus	400	83	85	85	88	WER3T04...
REG 3 + T- kus	600	83	85	85	88	WER3T06...
REG 3 + T- kus	800	83	85	85	88	WER3T08...
REG 3 + T- kus	1000	83	85	85	88	WER3T10...
REG 3 + T- kus	1200	83	85	85	88	WER3T12...

PŘEHLED KONFIGURACÍ:



Model	Výkon [W]	Obal	Barva	Druh kabelu
WE R3G REG 3	01 120	F fólie	916 Bílá	W Rovný kabel se zástrčkou 1,5m
R3T REG 3 + T- kus	02 200	T Tuba	SMA Stříbrná	P Přímý kabel do zdi bez zástrčky 1,5m
	03 300		CRO Chrom	U Kroucený kabel se zástrčkou 0,45m
	04 400		905 Černá	
	06 600			
	08 800			
	10 1000			
	12 1200			

REG 2



Název	Výkon [W]	Bílá Cena bez DPH [EUR]	Černá Cena bez DPH [EUR]	Stříbrná Cena bez DPH [EUR]	Chrom Cena bez DPH [EUR]	Kód produktu ... Kód konfigurace
REG 2	120	75	77	76	78	WER2G01...
REG 2	200	75	77	76	78	WER2G02...
REG 2	300	75	77	76	78	WER2G03...
REG 2	400	75	77	76	78	WER2G04...
REG 2	600	75	77	76	78	WER2G06...
REG 2	800	75	77	76	78	WER2G08...
REG 2	1000	75	77	76	78	WER2G10...
REG 2	1200	75	77	76	78	WER2G12...
REG 2 + T- kus	120	80	81	81	83	WER2T01...
REG 2 + T- kus	200	80	81	81	83	WER2T02...
REG 2 + T- kus	300	80	81	81	83	WER2T03...
REG 2 + T- kus	400	80	81	81	83	WER2T04...
REG 2 + T- kus	600	80	81	81	83	WER2T06...
REG 2 + T- kus	800	80	81	81	83	WER2T08...
REG 2 + T- kus	1000	80	81	81	83	WER2T10...
REG 2 + T- kus	1200	80	81	81	83	WER2T12...

PŘEHLED KONFIGURACÍ:



Model	Výkon [W]	Obal	Barva	Druh kabelu
WE R2G REG 2	01 120	F fólie	916 Bílá	P Přímý kabel do zdi bez zástrčky 1,5m
R2T REG 2 + T- kus	02 200	T Tuba	SMA Stříbrná	R Rovný kabel se zástrčkou s vypínačem 1,5m
	03 300		CRO Chrom	T Kroucený kabel se zástrčkou 0,45m s vypínačem
	04 400		905 Černá	W Rovný kabel se zástrčkou 1,5m (pro vypnutí vytažovat ze zásuvky)
	06 600			
	08 800			
	10 1000			
	12 1200			



Název	Výkon [W]	Nerezová ocel s bílým/šedým kabelem bez zástrčky Cena bez DPH [EUR]	Nerezová ocel s bílým/šedým kabelem se zástrčkou Cena bez DPH [EUR]	Kód produktu
SIM	100	61	61	WESIM01...
SIM	150	—	—	WESIM51...
SIM	200	61	61	WESIM02...
SIM	300	61	61	WESIM03...
SIM	400	61	61	WESIM04...
SIM	500	—	—	WESIM05...
SIM	600	61	61	WESIM06...
SIM	800	61	61	WESIM08...
SIM	1000	67	67	WESIM10...
SIM	1200	67	67	WESIM12...
SIM	1500	67	67	WESIM15...

PŘEHLED KONFIGURACÍ:



Model			Výkon [W]		Obal		Barva		Druh kabelu	
WE	SIM	SIM	01	120	F	fólie	INX	Nerezová ocel s bílým kabelem	R	Rovný kabel se zástrčkou s vypínačem 1,5m
			51	150			INS	Nerezová ocel s šedým kabelem	P	Přímý kabel do zdi bez zástrčky 1,5m
			02	200						
			03	300						
			04	400						
			05	500						
			06	600						
			08	800						
			10	1000						
			12	1200						
			15	1500						

Krytka SIM

Krytka topné tyče SIM, pro ukrytí připojení rovného kabelu bez zástrčky do zdi. V designu pro radiátory s kulatým i hranatým profilem, proveditelná v barvě radiátoru, aby elegantně ukryla topnou tyč a kabel.



MOŽNOSTI BAREVNÝCH ÚPRAV:

vzorník RAL, Speciálních barev, barev Premium, Chrom

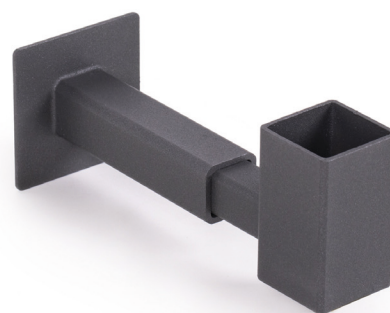

URČENÁ PRO TOPNÉ TYČE:

SIM

Velikost	Barva	Cena bez DPH [EUR] u barev Premium +25%	Kód produktu Kód konfigurace s. 368
84mm kulatá	Barvy RAL, Speciální barvy, Chrom a barvy Premium	23	WRMASIM002 K...
84mm hranatá 30x30	Barvy RAL, Speciální barvy, Chrom a barvy Premium	23	WRMASIM003 K...
120mm kulatá	Barvy RAL, Speciální barvy, Chrom a barvy Premium	25	WRMASIM004 K...
120mm hranatá 30x30	Barvy RAL, Speciální barvy, Chrom a barvy Premium	25	WRMASIM005 K...

Terma Split třída I

Topný element TS1 a Regulátory řady KTX tvoří kompletní topné tyče KTX4 Blue, KTX 4, KTX 3, KTX 2, KTX 1.



Název	Výkon [W]	Cena bez DPH [EUR]	Kód produktu
Terma Split třída I	120	33	WETS101 K---D
Terma Split třída I	200	33	WETS102 K---D
Terma Split třída I	300	33	WETS103 K---D
Terma Split třída I	400	33	WETS104 K---D
Terma Split třída I	600	33	WETS106 K---D
Terma Split třída I	800	33	WETS108 K---D
Terma Split třída I	1000	33	WETS110 K---D

Bojlerová topná tyč TNK



Název	Výkon [W]	Velikost závitů	Cena bez DPH [EUR]	Kód produktu
Bojlerová topná tyč TNK	2000	G 1 1/4	96	TGBTNK 54 20 W1
Bojlerová topná tyč TNK	3000	G 1 1/4	108	TGBTNK 54 30 W1
Bojlerová topná tyč TNK	2000	G 1 1/2	101	TGBTNK 64 20 W1
Bojlerová topná tyč TNK	3000	G 1 1/2	114	TGBTNK 64 30 W1

TTIR1 – Termostat s týdenním programem



Ovládá bezdrátově topné tyče KTX4, MOA IR, ONE.

Rozlišuje pracovní dny a víkend + další režimy.

Montáž na stěnu nebo volně stojící na polici.



Napájení bateriemi	Komunikační modul	Stupeň krytí IP	Barva	Cena bez DPH [EUR]	Kód produktu
2 x LR03 (AAA)	IR	IP 30	Bílá	104	TGRTBI001

DTIR1 – Termostat s denním programem



Ovládá bezdrátově topné tyče KTX4, MOA IR, ONE.

Nerozlišuje pracovní dny a víkend. Nastavíte program a ten potom spíná každý den stejně.



Napájení bateriemi	Komunikační modul	Stupeň krytí IP	Barva	Cena bez DPH [EUR]	Kód produktu
2 x LR03 (AAA)	IR	IP 30	Bílá	77	TGRDBI001
2 x LR03 (AAA)	IR	IP 30	Stříbrná	78	TGRDSI001

Ventily a příslušenství

Police a věšáky

Police EASY

DOSTUPNÝ MATERIÁL:

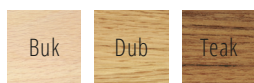

URČENÁ PRO RADIÁTORY:

Easy

Velikost [mm] (šíře radiátoru)	B [mm] (šíře produktu)	Materiál	Cena bez DPH [EUR]	Kód produktu a konfigurace
200	180	Buk	41	WRPEAS020 KBUK
200	180	Dub	43	WRPEAS020 KDAB
200	180	Teak	74	WRPEAS020 KTEK

Police SIMPLE

DOSTUPNÝ MATERIÁL:

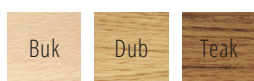

URČENÁ PRO RADIÁTORY:

Simple

Velikost [mm] (šíře radiátoru)	B [mm] (šíře produktu)	Materiál	Cena bez DPH [EUR]	Kód produktu a konfigurace
500	440	Buk	50	WRPSIM050 KBUK
500	440	Dub	56	WRPSIM050 KDAB
500	440	Teak	118	WRPSIM050 KTEK

Police STAND

DOSTUPNÝ MATERIÁL:

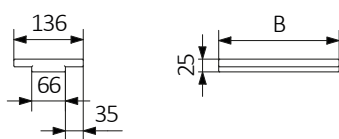

URČENÁ PRO RADIÁTORY:

Stand

Velikost [mm] (šíře radiátoru)	B [mm] (šíře produktu)	Materiál	Cena bez DPH [EUR]	Kód produktu a konfigurace
300	236	Buk	43	WRPSCA030 KBUK
300	236	Dub	58	WRPSCA030 KDAB
300	236	Teak	126	WRPSCA030 KTEK
400	336	Buk	45	WRPSCA040 KBUK
400	336	Dub	62	WRPSCA040 KDAB
400	336	Teak	144	WRPSCA040 KTEK
500	436	Buk	48	WRPSCA050 KBUK
500	436	Dub	65	WRPSCA050 KDAB
500	436	Teak	176	WRPSCA050 KTEK

Police TRIGA

DOSTUPNÝ MATERIÁL:

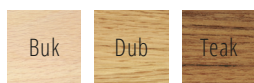

MONTÁŽNÍ MADLA:



URČENÁ PRO RADIÁTORY:

Triga

Velikost [mm] (šíře radiátoru)	B [mm] (šíře produktu)	Materiál	Cena bez DPH [EUR]	Kód produktu a konfigurace
380	410	Buk	78	WRPTRG038 KBUK
380	410	Dub	78	WRPTRG038 KDAB
380	410	Teak	132	WRPTRG038 KTEK
480	510	Buk	80	WRPTRG048 KBUK
480	510	Dub	82	WRPTRG048 KDAB
480	510	Teak	157	WRPTRG048 KTEK
580	610	Buk	84	WRPTRG058 KBUK
580	610	Dub	86	WRPTRG058 KDAB
580	610	Teak	173	WRPTRG058 KTEK
680	710	Buk	86	WRPTRG068 KBUK
680	710	Dub	89	WRPTRG068 KDAB
680	710	Teak	186	WRPTRG068 KTEK

Police s držákem TRIGA

DOSTUPNÝ MATERIÁL:



MONTÁŽNÍ MADLA:



URČENÁ PRO RADIÁTORY:

Triga

Velikost [mm] (šíře radiátoru)	B [mm] (šíře produktu)	Materiál	Cena bez DPH [EUR]	Kód produktu a konfigurace
380	410	Buk	82	WRQTRG038 KBUK
380	410	Dub	84	WRQTRG038 KDAB
380	410	Teak	147	WRQTRG038 KTEK
480	510	Buk	84	WRQTRG048 KBUK
480	510	Dub	86	WRQTRG048 KDAB
480	510	Teak	167	WRQTRG048 KTEK
580	610	Buk	86	WRQTRG058 KBUK
580	610	Dub	88	WRQTRG058 KDAB
580	610	Teak	188	WRQTRG058 KTEK
680	710	Buk	89	WRQTRG068 KBUK
680	710	Dub	93	WRQTRG068 KDAB
680	710	Teak	208	WRQTRG068 KTEK

Držák TRIGA

DOSTUPNÝ MATERIÁL:



MONTÁŽNÍ MADLA:



URČEN PRO RADIÁTORY:

Triga

Velikost [mm] (šířka radiátoru)	B [mm] (šířka produktu)	Materiál	Cena bez DPH [EUR]	Kód produktu a konfigurace
380	410	Buk	78	WRRTRG038 KBUK
380	410	Dub	78	WRRTRG038 KDAB
380	410	Teak	132	WRRTRG038 KTEK
480	510	Buk	80	WRRTRG048 KBUK
480	510	Dub	82	WRRTRG048 KDAB
480	510	Teak	157	WRRTRG048 KTEK
580	610	Buk	84	WRRTRG058 KBUK
580	610	Dub	86	WRRTRG058 KDAB
580	610	Teak	173	WRRTRG058 KTEK
680	710	Buk	86	WRRTRG068 KBUK
680	710	Dub	89	WRRTRG068 KDAB
680	710	Teak	186	WRRTRG068 KTEK

Držák BELT

MOŽNOSTI BAREVNÝCH ÚPRAV:

vzorník RAL, Speciálních barev, barev Premium a Chrom



Určen pro radiátory Triga



Velikost [mm] (šířka radiátoru)	B [mm]	Barvy RAL a speciální barvy Cena bez DPH [EUR]	Chrom a barvy Premium Cena bez DPH [EUR]	Kód produktu ... Kód konfigurace 364
380	388	35	40	WRRRGT038...
480	488	37	43	WRRRGT048...
580	588	39	46	WRRRGT058...
680	688	41	49	WRRRGT068...
780	788	43	52	WRRRGT078...
880	888	45	55	WRRRGT088...

Háček bodový HANDY GRIP

MOŽNOSTI BAREVNÝCH ÚPRAV:

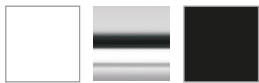

URČEN PRO RADIÁTORY:

Určen pro trubkové radiátory s kulatými profily.
Sada obsahuje dva háčky.

Barva	Cena bez DPH [EUR]	Kód produktu
Bílá	21	TGWBI010
Chrom	23	TGWCR008
Černá Mat	22	TGWCZ003

Háček bodový HANDY VIP

MOŽNOSTI BAREVNÝCH ÚPRAV:



URČEN PRO RADIÁTORY:

Určen pro trubkové radiátory s kulatými profily.
Sada obsahuje dva háčky.

Barva	Cena bez DPH [EUR]	Kód produktu
Bílá	21	TGWBI005
Chrom	23	TGWCR005
Černá Mat	22	TGWCZ001

Háček bodový KUKA

MOŽNOSTI BAREVNÝCH ÚPRAV (CHROM A NOVINKA V BARVÁCH PREMIUM):

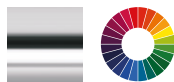

URČEN PRO RADIÁTORY:

Kuka 50 – Sherwood, Vivo

Kuka 70 – Cyklon

Velikost	Barva	Cena bez DPH [EUR]	Kód produktu ... Kód konfigurace 364
50 x 10 mm	Chrom a barvy Premium	44	WRWKUK001...
70 x 11 mm	Chrom a barvy Premium	44	WRWKUK002...

Háček bodový SPARK

MOŽNOSTI BAREVNÝCH ÚPRAV (CHROM A NOVINKA V BARVÁCH PREMIUM):

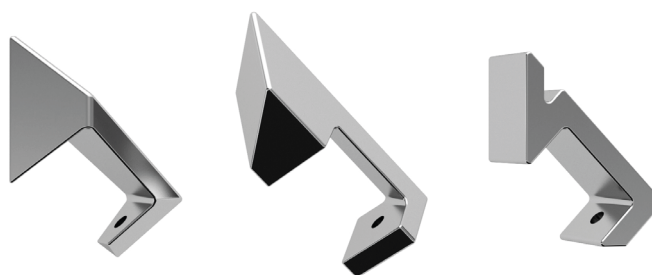

Spark 1

Spark 2

Spark 3

URČEN PRO RADIÁTORY:

Diamond

Verze	Velikost	Barva	Cena bez DPH [EUR]	Kód produktu ... Kód konfigurace 364
SPARK 1	25 mm	Chrom a barvy Premium	46	WRWSP1025...
SPARK 2	25 mm	Chrom a barvy Premium	46	WRWSP2025...
SPARK 3	25 mm	Chrom a barvy Premium	46	WRWSP3025...

Háček bodový Yo!

URČEN PRO RADIÁTORY:

Aero H, Aero HG, Alex, Alex One, Domi, Fiona, Fiona One, Iron D, Iron S, Lena, Lima, Lima One, POC 2, Pola, Pola One, Tytus, Tytus One



Barva	Cena bez DPH [EUR]	Kód produktu
hnědá	5	WRWYOY001 SBRZ
červená	5	WRWYOY001 SCZE
zelená	5	WRWYOY001 SZIE
žlutá	5	WRWYOY001 SZOL
šedá	5	WRWYOY001 SSZA
modrá	5	WRWYOY001 SNIE
bílá	5	WRWJPU001 SBIA
černá	5	WRWYOY001 SCZA

Háček bodový ZIP H

MOŽNOSTI BAREVNÝCH ÚPRAV:

Chrom a **NOVINKA** v barvách Premium + Černá Polomat 9M5 a Mat S95 + Bílá Polomat J16 a Mat S96



URČEN PRO RADIÁTORY:

Zip H 10 – Dexter, Dexter Pro, City, Iron D, Iron S, Kioto, Lukka, Marlin, Mantis, Incorner, Outcorner, Quadrus Slim, Quadrus Bold, Warp S, Warp T, Warp T Bold, Vivo

Zip H 20 – Bone

Velikost	Barva	Cena bez DPH [EUR]	Kód produktu <small>... Kód konfigurace 364</small>
10 mm	Chrom a barvy Premium + Černá a Bílá Polomat a Mat	42	WRWZIP008...
20 mm	Chrom a barvy Premium + Černá a Bílá Polomat a Mat	42	WRWZIP010...

Háček bodový ZIP V

MOŽNOSTI BAREVNÝCH ÚPRAV:

Chrom a **NOVINKA** v barvách Premium + Černá Polomat 9M5 a Mat S95 + Bílá Polomat J16 a Mat S96



Chrom

URČEN PRO RADIÁTORY:

Zip V 10 – Nemo

Zip V 20 – Intra, Intra M

Zip V 30 – Angus, Easy, Triga (AW, AN), Sherwood, Simple, ZigZag

Zip V 40 – Triga

Velikost	Barva	Cena bez DPH [EUR]	Kód produktu <small>... Kód konfigurace 364</small>
10 mm	Chrom a barvy Premium + Černá a Bílá Polomat a Mat	42	WRWZIP009 ...
20 mm	Chrom a barvy Premium + Černá a Bílá Polomat a Mat	42	WRWZIP011 ...
30 mm	Chrom a barvy Premium + Černá a Bílá Polomat a Mat	44	WRWZIP012 ...
40 mm	Chrom a barvy Premium + Černá a Bílá Polomat a Mat	44	WRWZIP013 ...

Držák vyhnutý BASIC

MOŽNOSTI BAREVNÝCH ÚPRAV:



Držák na ručníky vhodný pro radiátory s přímou trubkou.

Dodává se ve dvou velikostech pro šířky radiátorů větší než 450 mm a 550 mm.

URČEN PRO RADIÁTORY:

Určeno pro radiátory s kulatými vyhnutými příčkami (LENA, DOMI, DEXTER)

Velikost	Barva	Cena bez DPH [EUR]	Kód produktu
Ø 16/L340 mm	Bílá	28	TGWBI004
Ø 16/L340 mm	Chrom	32	TGWCR004
Ø 16/L430 mm	Bílá	28	TGWBI002
Ø 16/L430 mm	Chrom	32	TGWCR002

Držák BASIC

MOŽNOSTI BAREVNÝCH ÚPRAV:



Držák na ručníky vhodný pro radiátory s přímou trubicí.
Dodává se ve dvou velikostech pro šířky radiátorů větší než 450 mm a 550 mm.

URČEN PRO RADIÁTORY:

Určeno pro radiátory s kulatými rovnými příčkami (FIONA, MIKE)

Velikost	Barva	Cena bez DPH [EUR]	Kód produktu
Ø 16/L370 mm	Bílá	28	TGWBI003
Ø 16/L370 mm	Chrom	32	TGWCR003
Ø 16/L460 mm	Bílá	28	TGWBI001
Ø 16/L460 mm	Chrom	32	TGWCR001

Háček bodový HAPPY HIPPO

MOŽNOSTI BAREVNÝCH ÚPRAV:

vzorník RAL, Speciálních barev, barev Premium, bez Chromu

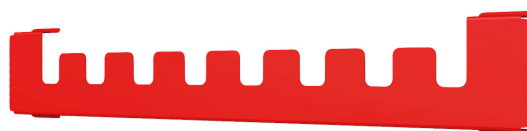

URČEN PRO RADIÁTORY:

Vivo

Velikost	Barva	Cena bez DPH [EUR] u barev Premium +25%	Kód produktu Kód konfigurace s. 368
300 mm	Barvy RAL, Speciální barvy a barvy Premium	16	WRWH1C024...
400 mm	Barvy RAL, Speciální barvy a barvy Premium	16	WRWH1C034 ...
500 mm	Barvy RAL, Speciální barvy a barvy Premium	16	WRWH1C044 ...
600 mm	Barvy RAL, Speciální barvy a barvy Premium	16	WRWH1C054 ...

Háček bodový HAPPY RABBIT

MOŽNOSTI BAREVNÝCH ÚPRAV:

vzorník RAL, Speciálních barev, barev Premium, bez Chromu



URČEN PRO RADIÁTORY

Vivo

Velikost	Barva	Cena bez DPH [EUR] u barev Premium +25%	Kód produktu Kód konfigurace s. 368
300 mm	Barvy RAL, Speciální barvy a barvy Premium	16	WRWH1B024 ...
400 mm	Barvy RAL, Speciální barvy a barvy Premium	16	WRWH1B034 ...
500 mm	Barvy RAL, Speciální barvy a barvy Premium	16	WRWH1B044 ...
600 mm	Barvy RAL, Speciální barvy a barvy Premium	16	WRWH1B054 ...

Háček bodový HAPPY SHARK

MOŽNOSTI BAREVNÝCH ÚPRAV:

vzorník RAL, Speciálních barev, barev Premium, bez Chromu



URČEN PRO RADIÁTORY:

Vivo

Velikost	Barva	Cena bez DPH [EUR] u barev Premium +25%	Kód produktu Kód konfigurace s. 368
300 mm	Barvy RAL, Speciální barvy a barvy Premium	16	WRWH1A024 ...
400 mm	Barvy RAL, Speciální barvy a barvy Premium	16	WRWH1A034 ...
500 mm	Barvy RAL, Speciální barvy a barvy Premium	16	WRWH1A044 ...
600 mm	Barvy RAL, Speciální barvy a barvy Premium	16	WRWH1A054 ...

Háček bodový SIMPLE

MOŽNOSTI BAREVNÝCH ÚPRAV:

vzorník RAL, Speciálních barev, barev Premium, bez Chromu

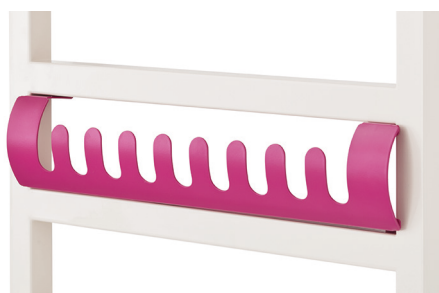

URČEN PRO RADIÁTORY:

Simple

Velikost	Barva	Cena bez DPH [EUR] u barev Premium +25%	Kód produktu Kód konfigurace: 368
500 mm	Barvy RAL, Speciální barvy a barvy Premium	20	WRWSIM004 ...

Držák CASE SLIM

MOŽNOSTI BAREVNÝCH ÚPRAV:

vzorník RAL, Speciálních barev, barev Premium, Chrom



URČEN PRO RADIÁTORY:

Case Slim

Velikost [mm] (šíře radiátoru)	B [mm] (šíře produktu)	Barva	Cena bez DPH [EUR] u barev Premium +25%	Kód produktu Kód konfigurace: 368
420 mm	448 mm	Barvy RAL, Speciální barvy a barvy Premium	37	WRRCSS042 ...
520 mm	548 mm	Barvy RAL, Speciální barvy a barvy Premium	37	WRRCSS052 ...
620 mm	648 mm	Barvy RAL, Speciální barvy a barvy Premium	38	WRRCSS062 ...
420 mm	448 mm	Chrom	45	WRRCSS042 ...
520 mm	548 mm	Chrom	46	WRRCSS052 ...
620 mm	648 mm	Chrom	49	WRRCSS062 ...

Stoupačkový profil k radiátoru Michelle

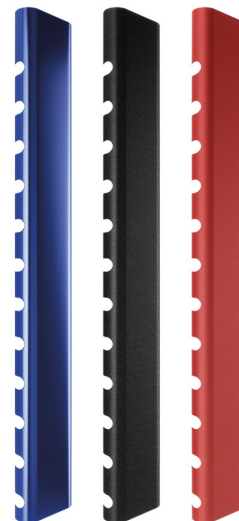

MOŽNOSTI BAREVNÝCH ÚPRAV:

vzorník RAL, Speciálních barev, barev Premium, Chrom

URČEN PRO RADIÁTORY:

Michelle

Velikost A ∇ [mm]	Orientace [pro připojení YL Levá, pro YP Pravá]	Barva Cena bez DPH [EUR] u barev Premium +25%	Chrom Cena bez DPH [EUR]	Kód produktu ...Kód konfigurace s. 368
780 mm	Levá	59	115	WRCMIC078L...
780 mm	Pravá	59	115	WRCMIC078P...
1200 mm	Levá	68	153	WRCMIC120L...
1200 mm	Pravá	68	153	WRCMIC120P...
1620 mm	Levá	77	192	WRCMIC162L...
1620 mm	Pravá	77	192	WRCMIC162P...

Stoupačkový profil k radiátoru Iron D a Iron S

MOŽNOSTI BAREVNÝCH ÚPRAV:

vzorník RAL, Speciálních barev, barev Premium

URČEN PRO RADIÁTORY:

Iron D i Iron S stejná velikost pro
šíře radiátorů 400, 500 i 600mm.

Velikost A ∇ [mm]	Cena bez DPH [EUR] u barev Premium +25%	Kód produktu ...Kód konfigurace s. 368
730 mm	78	WRCIRX073...
925 mm	85	WRCIRX092...
1120 mm	93	WRCIRX112...
1315 mm	100	WRCIRX131...
1510 mm	107	WRCIRX151...
1705 mm	114	WRCIRX170...

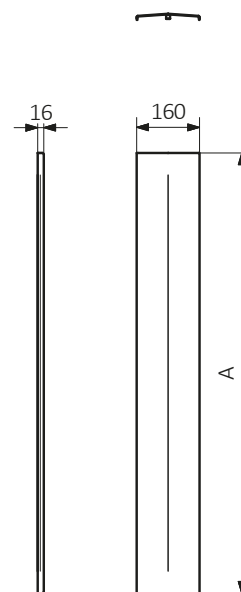

Sady ventilů

Sada Dexter regulační

DOSTUPNÉ VERZE:



Levá



Pravá

MOŽNOSTI BAREVNÝCH ÚPRAV:



PŘIPOJENÍ:



URČENÁ PRO RADIÁTORY:

Dexter



Orientace	Velikost	Barva	Cena bez DPH [EUR]	Kód produktu
Levá	GZ 1/2" – Ø16x2, Ø15	Bílá	129	TGERCD2-BI
Pravá	GZ 1/2" – Ø16x2, Ø15	Bílá	129	TGERCD1-BI
Levá	GZ 1/2" – Ø16x2, Ø15	Chrom	131	TGERCD1-CR
Pravá	GZ 1/2" – Ø16x2, Ø15	Chrom	131	TGERCD2-CR
Levá	GZ 1/2" – Ø16x2, Ø15	Satén	174	TGERCD1-ST
Pravá	GZ 1/2" – Ø16x2, Ø15	Satén	174	TGERCD2-ST

Sada termostatická Dexter

DOSTUPNÉ VERZE:



Levá

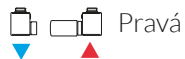

Pravá

MOŽNOSTI BAREVNÝCH ÚPRAV:



PŘIPOJENÍ:



URČENÁ PRO RADIÁTORY:

Dexter



Orientace	Velikost	Barva	Cena bez DPH [EUR]	Kód produktu
Levá	GZ 1/2" – Ø16x2, Ø15	Bílá	170	TGETCG1-BI
Pravá	GZ 1/2" – Ø16x2, Ø15	Bílá	170	TGETCG2-BI
Levá	GZ 1/2" – Ø16x2, Ø15	Chrom	174	TGETCG6-CR
Pravá	GZ 1/2" – Ø16x2, Ø15	Chrom	174	TGETCG7-CR
Levá	GZ 1/2" – Ø16x2, Ø15	Satén	223	TGETCG1-ST
Pravá	GZ 1/2" – Ø16x2, Ø15	Satén	223	TGETCG2-ST

Sada rohová regulační „Wood”

MOŽNOSTI BAREVNÝCH ÚPRAV:



PŘIPOJENÍ:

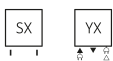

URČENÁ PRO RADIÁTORY:

Pajak

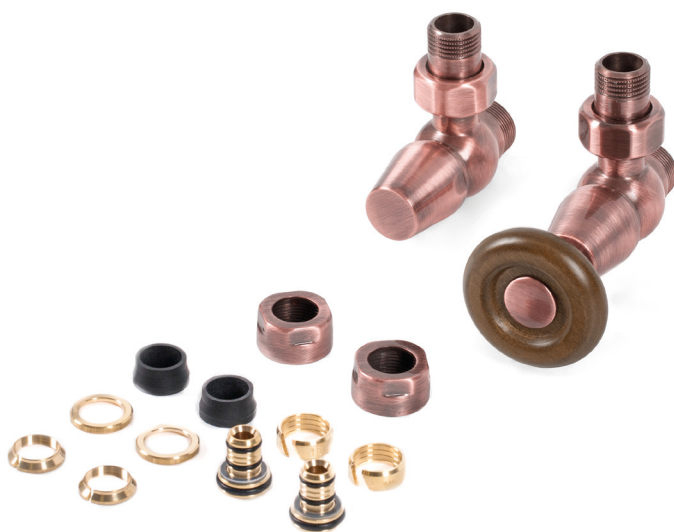

Velikost	Barva	Cena bez DPH [EUR]	Kód produktu
GZ 1/2" – Ø16x2, Ø15	Měď kartáčovaná	209	TGERME001

Sada regulační rohová

MOŽNOSTI BAREVNÝCH ÚPRAV:



PŘIPOJENÍ:

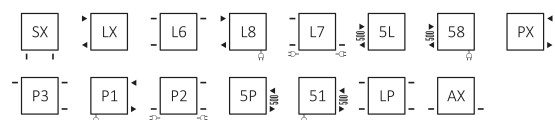

Velikost	Barva	Cena bez DPH [EUR]	Kód produktu
GZ 1/2" - Ø16x2, Ø15	Chrom	99	WRZRCK1-CR

Sada regulační rohová Star

MOŽNOSTI BAREVNÝCH ÚPRAV:



PŘIPOJENÍ:

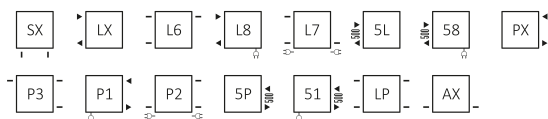

Velikost	Barva	Cena bez DPH [EUR]	Kód produktu
GZ 1/2" – Ø16x2, Ø15	Chrom	148	TGERSTCR01

Sada rohová termostatická

MOŽNOSTI BAREVNÝCH ÚPRAV:



PŘIPOJENÍ:

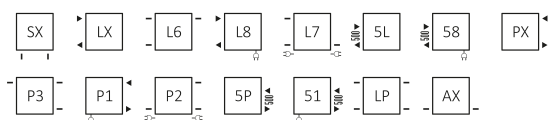

Velikost	Barva	Cena bez DPH [EUR]	Kód produktu
GZ 1/2" - Ø16x2, Ø15	Chrom	134	WRZTCG3-CR

Sada tříosová regulační

DOSTUPNÉ VERZE:



MOŽNOSTI BAREVNÝCH ÚPRAV:



PŘIPOJENÍ:



Orientace	Velikost	Barva	Cena bez DPH [EUR]	Kód produktu
Levá	GZ 1/2" – Ø16x2, Ø15	Chrom	99	WRZRC31-CR
Pravá	GZ 1/2" – Ø16x2, Ø15	Chrom	99	WRZRC32-CR

Sada tříosová termostatická

DOSTUPNÉ VERZE:

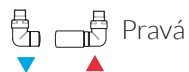

MOŽNOSTI BAREVNÝCH ÚPRAV:



PŘIPOJENÍ:



Orientace	Velikost	Barva	Cena bez DPH [EUR]	Kód produktu
Levá	GZ 1/2" – Ø16x2, Ø15	Chrom	143	WRZTCG1-CR
Pravá	GZ 1/2" – Ø16x2, Ø15	Chrom	143	WRZTCG2-CR

Sada tříosová termostatická s možností montáže topné tyče skrz ventil

DOSTUPNÉ VERZE:



Levá



Pravá

MOŽNOSTI BAREVNÝCH ÚPRAV:



PŘIPOJENÍ:



Orientace	Velikost	Barva	Cena bez DPH [EUR]	Kód produktu
Levá	GZ 1/2" – Ø16x2, Ø15	Chrom	147	WRZTCG4-CR
Pravá	GZ 1/2" – Ø16x2, Ø15	Chrom	147	WRZTCG5-CR

Integrovaná sada termostatická

DOSTUPNÉ VERZE:

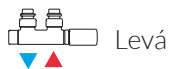

MOŽNOSTI BAREVNÝCH ÚPRAV:



PŘIPOJENÍ:

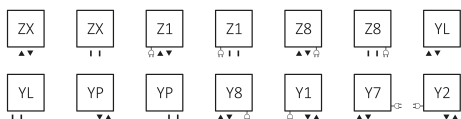

DOPORUČUJEME: SADA KRYCÍ INTEGROVANÁ, CHROM

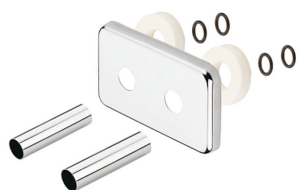

TGPCR002: 38EUR

Strona: 323

Orientace	Velikost	Barva	Cena bez DPH [EUR]	Kód produktu
Ventil rohový – 90°				
Levá	GZ 1/2" – Ø16x2, Ø15	Chrom	145	WRZT5G1-CR
Pravá	GZ 1/2" – Ø16x2, Ø15	Chrom	145	WRZT5G2-CR
Ventil přímý				
Levá	GZ 1/2" – Ø16x2, Ø15	Chrom	146	WRZT5G3-CR
Pravá	GZ 1/2" – Ø16x2, Ø15	Chrom	146	WRZT5G4-CR

Sada komplexní integrovaný ventil s T- kusem s možností připojení topné tyče skrze ventil

DOSTUPNÉ VERZE (TOPNÁ TYČ SE MONTUJE NA VÝSTUPU):

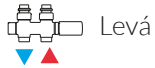

MOŽNOSTI BAREVNÝCH ÚPRAV:



URČENÁ PRO RADIÁTORY:

Michelle, Warp S, Iron D, Iron S



DOPORUČUJEME: SADA KRYCÍ INTEGROVANÁ, CHROM

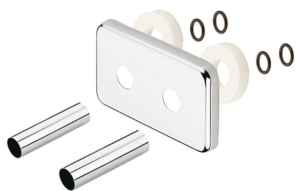

TGPCR002: 38 EUR

Strona: 323

Orientace	Velikost	Barva	Cena bez DPH [EUR]	Kód produktu
Levá	GZ 1/2" – Ø16x2, Ø15	Chrom	188	WRZT5G14-CR
Pravá	GZ 1/2" – Ø16x2, Ø15	Chrom	188	WRZT5G15-CR

Integrovaná sada termostatická s ponornou trubicí

DOSTUPNÉ VERZE:



Levá



Pravá

MOŽNOSTI BAREVNÝCH ÚPRAV:



PŘIPOJENÍ:



DOPORUČUJEME: SADA KRYCÍ INTEGROVANÁ, CHROM

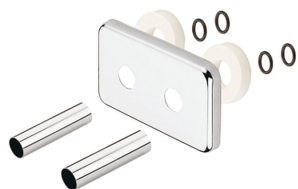

TGPCR002:38EUR
Strona: 323

Orientace	Velikost	Barva	Cena bez DPH [EUR]	Kód produktu
Ventil rohový – 90°				
Levá	GZ 1/2" – Ø16x2, Ø15	Chrom	151	WRZT5G5-CR
Pravá	GZ 1/2" – Ø16x2, Ø15	Chrom	151	WRZT5G6-CR
Ventil přímý				
—	GZ 1/2" – Ø16x2, Ø15	Chrom	151	WRZT5G7-CR

Integrovaná sada uzavírací

MOŽNOSTI BAREVNÝCH ÚPRAV:



PŘIPOJENÍ:



DOPORUČUJEME: SADA KRYCÍ INTEGROVANÁ, CHROM

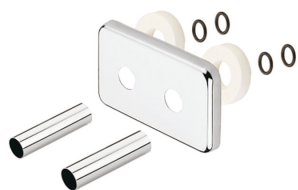

TGPCR002: 38EUR
Strona: 323

Velikost	Barva	Cena bez DPH [EUR]	Kód produktu
Ventil rohový – 90°			
GZ 1/2" – Ø16x2, Ø15	Chrom	116	WRZOSSC1-CR
Ventil přímý			
GW 3/4" (GZ 1/2") – Ø16x2, Ø15	Chrom	116	WRZOSSC2-CR

Integrovaná sada termostatická TWINS ALL IN ONE

MOŽNOSTI BAREVNÝCH ÚPRAV:

Ve všech Barvách RAL, barvách Premium a speciálních barvách*.

PŘIPOJENÍ:

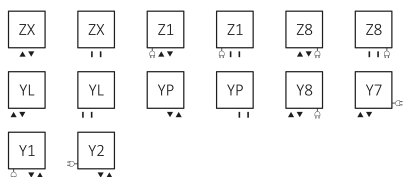

DOSTUPNÉ VERZE:



SADA OBSAHUJE:

Integrovaná sada termostatická
Termostatická hlavice M30 × 1.5
Sada krycí

2 × Adaptér PEX, ALU-PEX 16×2
2 × Adaptér CU Ø 15

Skladem v barvách: Chrom, Černá, Černá Polomat, Bílá Mat, Bílá

Orientace	Barva	Cena bez DPH u barev Premium +25% do barev RAL [EUR]	Kód produktu	Kód konfigurace
Pravá	Chrom	124	TGETTWINP	KCRO
Levá	Chrom	124	TGETTWINL	KCRO
Pravá	Černá	131	TGETTWINP	K9P5
Levá	Černá	131	TGETTWINL	K9P5
Pravá	Černá Polomat	131	TGETTWINP	K9M5
Levá	Černá Polomat	131	TGETTWINL	K9M5
Pravá	Bílá Mat	131	TGETTWINP	KS96
Levá	Bílá Mat	131	TGETTWINL	KS96
Pravá	Bílá	124	TGETTWINP	K916
Levá	Bílá	124	TGETTWINL	K916
Pravá	Barvy RAL a speciální barvy*	159	TGETTWINP	K... Kód konfigurace s. 314
Levá	Barvy RAL a speciální barvy*	159	TGETTWINL	K... Kód konfigurace s. 314

* nelze: Black Crocodile New, White Gold, SOFT ani MATT od všech RAL(pouze SOFT 9005, SOFT 9016, SOFT 7047, MATT 7016 a MATT 9016 jde)

Integrovaná sada termostatická s ponor- nou trubicí UNICO ALL IN ONE

MOŽNOSTI BAREVNÝCH ÚPRAV:

Ve všech Barvách RAL, barvách Premium a speciálních barvách*.

PŘIPOJENÍ:



DOSTUPNÉ VERZE:



SADA OBSAHUJE:

Integrovaná sada termostatická s ponor-
nou trubicí
Termostatická hlavice M30 x 1.5
Sada krycí

2 x Adaptér PEX, ALU-PEX 16x2
2 x Adaptér CU Ø 15

Skladem v barvách: Chrom, Černá, Černá Polomat, Bílá Mat, Bílá

Orientace	Barva	Cena bez DPH u barev Premium +25% do barev RAL [EUR]	Kód produktu	Kód konfigurace
Pravá	Chrom	128	TGETUNICP	KCRO
Levá	Chrom	128	TGETUNICL	KCRO
Pravá	Černá	133	TGETUNICP	K9P5
Levá	Černá	133	TGETUNICL	K9P5
Pravá	Černá Polomat	133	TGETUNICP	K9M5
Levá	Černá Polomat	133	TGETUNICL	K9M5
Pravá	Bílá Mat	133	TGETUNICP	KS96
Levá	Bílá Mat	133	TGETUNICL	KS96
Pravá	Bílá	128	TGETUNICP	K916
Levá	Bílá	128	TGETUNICL	K916
Pravá	Barvy RAL a speciální barvy*	162	TGETUNICP	K... Kód konfigurace s. 314
Levá	Barvy RAL a speciální barvy*	162	TGETUNICL	K... Kód konfigurace s. 314

* nelze: Black Crocodile New, White Gold, SOFT ani MATT od všech RAL(pouze SOFT 9005, SOFT 9016, SOFT 7047, MATT 7016 a MATT 9016 jde)

Sada tříosová termostatická INTEGRA ALL IN ONE s možností montáže topné tyče skrz ventil

MOŽNOSTI BAREVNÝCH ÚPRAV:

Ve všech Barvách RAL, barvách Premium a speciálních barvách*.

PŘIPOJENÍ:



DOSTUPNÉ VERZE:



SADA OBSAHUJE:

Ventil tříosý termostatický
Ventil tříosý uzavírací s možností montáže topné tyče skrz ventil
Termostatická hlavice M30 x 1.5

Sada krycí
2 x Adaptér PEX, ALU-PEX 16x2
2 x Adaptér CU Ø 15

Skladem v barvách: Chrom, Černá, Černá Polomat, Bílá Mat, Bílá

Orientace	Barva	Cena bez DPH u barev Premium +25% do barev RAL [EUR]	Kód produktu	Kód konfigurace
Pravá	Chrom	126	TGETINTEP	KCRO
Levá	Chrom	126	TGETINTEL	KCRO
Pravá	Černá	133	TGETINTEP	K9P5
Levá	Černá	133	TGETINTEL	K9P5
Pravá	Černá Polomat	133	TGETINTEP	K9M5
Levá	Černá Polomat	133	TGETINTEL	K9M5
Pravá	Bílá Mat	133	TGETINTEP	KS96
Levá	Bílá Mat	133	TGETINTEL	KS96
Pravá	Bílá	126	TGETINTEP	K916
Levá	Bílá	126	TGETINTEL	K916
Pravá	Barvy RAL a speciální barvy*	161	TGETINTEP	K... Kód konfigurace s. 314
Levá	Barvy RAL a speciální barvy*	161	TGETINTEL	K... Kód konfigurace s. 314

* nelze: Black Crocodile New, White Gold, SOFT ani MATT od všech RAL(pouze SOFT 9005, SOFT 9016, SOFT 7047, MATT 7016 a MATT 9016 jde)

Sada tříosová termostatická VISION ALL IN ONE

MOŽNOSTI BAREVNÝCH ÚPRAV:

Ve všech Barvách RAL, barvách Premium a speciálních barvách*.

PŘIPOJENÍ:



DOSTUPNÉ VERZE:



SADA OBSAHUJE:

Ventil tříosý termostatický
Ventil tříosý uzavírací
Termostatická hlavice M30 x 1.5

Sada krycí
2 x Adaptér PEX, ALU-PEX 16x2
2 x Adaptér CU Ø 15

Skladem v barvách: Chrom, Černá, Černá Polomat, Bílá Mat, Bílá

Orientace	Barva	Cena bez DPH u barev Premium +25% do barev RAL [EUR]	Kód produktu	Kód konfigurace
Pravá	Chrom	102	TGETVISIP	KCRO
Levá	Chrom	102	TGETVISIL	KCRO
Pravá	Černá	109	TGETVISIP	K9P5
Levá	Černá	109	TGETVISIL	K9P5
Pravá	Černá Polomat	109	TGETVISIP	K9M5
Levá	Černá Polomat	109	TGETVISIL	K9M5
Pravá	Bílá Mat	109	TGETVISIP	KS96
Levá	Bílá Mat	109	TGETVISIL	KS96
Pravá	Bílá	102	TGETVISIP	K916
Levá	Bílá	102	TGETVISIL	K916
Pravá	Barvy RAL a speciální barvy*	137	TGETVISIP	K... Kód konfigurace s. 314
Levá	Barvy RAL a speciální barvy*	137	TGETVISIL	K... Kód konfigurace s. 314

* nelze: Black Crocodile New, White Gold, SOFT ani MATT od všech RAL (pouze SOFT 9005, SOFT 9016, SOFT 7047, MATT 7016 a MATT 9016 jde)

Sada tříosová regulační VISION ALL IN ONE

MOŽNOSTI BAREVNÝCH ÚPRAV:

Ve všech Barvách RAL, barvách Premium a speciálních barvách*.

PŘIPOJENÍ:



DOSTUPNÉ VERZE:



SADA OBSAHUJE:

Ventil tříosý regulační
Ventil tříosý uzavírací
Sada krycí

2 × Adaptér PEX, ALU-PEX 16×2
2 × Adaptér CU Ø 15

Skladem v barvách: Chrom, Černá, Černá Polomat, Bílá Mat, Bílá

Orientace	Barva	Cena bez DPH u barev Premium +25% do barev RAL [EUR]	Kód produktu	Kód konfigurace
Pravá	Chrom	83	TGERVISIP	KCRO
Levá	Chrom	83	TGERVISIL	KCRO
Pravá	Černá	90	TGERVISIP	K9P5
Levá	Černá	90	TGERVISIL	K9P5
Pravá	Černá Polomat	90	TGERVISIP	K9M5
Levá	Černá Polomat	90	TGERVISIL	K9M5
Pravá	Bílá Mat	90	TGERVISIP	KS96
Levá	Bílá Mat	90	TGERVISIL	KS96
Pravá	Bílá	83	TGERVISIP	K916
Levá	Bílá	83	TGERVISIL	K916
Pravá	Barvy RAL a speciální barvy*	118	TGERVISIP	K... Kód konfigurace s. 314
Levá	Barvy RAL a speciální barvy*	118	TGERVISIL	K... Kód konfigurace s. 314

* nelze: Black Crocodile New, White Gold, SOFT ani MATT od všech RAL(pouze SOFT 9005, SOFT 9016, SOFT 7047, MATT 7016 a MATT 9016 jde)

Integrovaná sada uzavírací PREMIUM rohová ALL IN ONE

MOŽNOSTI BAREVNÝCH ÚPRAV:

Ve všech Barvách RAL, barvách Premium a speciálních barvách*.

PŘIPOJENÍ:



DOSTUPNÉ VERZE:

W ZESTAWIE:

Przyłącze kątowe Exclusive chrom 3/4 GW
Rozeta podwójna prostokątna
Głowica termostatyczna M30 x 1.5

Tulejka maskująca 1/2" 50 mm
Złączki zaciskowe M 22x1,5

Skladem v barvách: Chrom, Černá, Černá Polomat, Bílá Mat, Bílá

Barva	Cena bez DPH u barev Premium +25% do barev RAL [EUR]	Kód produktu	Kód konfigurace
Chrom	102	TGETPREMK	KCRO
Černá	109	TGETPREMK	K9P5
Černá Polomat	109	TGETPREMK	K9M5
Černá Mat	109	TGETPREMK	KS95
Bílá Mat	109	TGETPREMK	KS96
Bílá	102	TGETPREMK	K916
Barvy RAL a speciální barvy*	139	TGETPREMK	K... Kód konfigurace s. 314

* nelze: Black Crocodile New, White Gold, SOFT ani MATT od všech RAL (pouze SOFT 9005, SOFT 9016, SOFT 7047, MATT 7016 a MATT 9016 jde)

Sada rohová termostatická ALL IN ONE

MOŽNOSTI BAREVNÝCH ÚPRAV:

Ve všech Barvách RAL, barvách Premium a speciálních barvách*.

PŘIPOJENÍ:

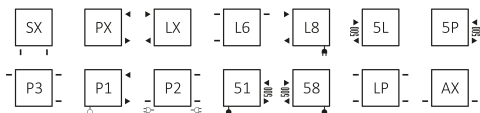

DOSTUPNÉ VERZE:

W ZESTAWIE:

Zawór grzejnikowy kątowy Royal GW 1/2"
Zawór odcinający kątowy Swing GW 1/2"
Rozeta pojedyncza Ø 22

Tulejka maskująca 1/2" 50 mm
Głowica termostaticzna M30 x 1.5
Złączki zaciskowe M 22x1,5

Skladem v barvách: Chrom, Černá, Černá Polomat, Bílá Mat, Bílá

Barva	Cena bez DPH u barev Premium +25% do barev RAL [EUR]	Kód produktu	Kód konfigurace
Chrom	114	TGETROYTK	KCRO
Černá	121	TGETROYTK	K9P5
Černá Polomat	121	TGETROYTK	K9M5
Černá Mat	121	TGETROYTK	KS95
Bílá Mat	121	TGETROYTK	KS96
Bílá	114	TGETROYTK	K916
Barvy RAL a speciální barvy*	149	TGETROYTK	WSTAW KOD

* nelze: Black Crocodile New, White Gold, SOFT ani MATT od všech RAL(pouze SOFT 9005, SOFT 9016, SOFT 7047, MATT 7016 a MATT 9016 jde)

Sada krycí integrovaná

MOŽNOSTI BAREVNÝCH ÚPRAV:



PŘIPOJENÍ:

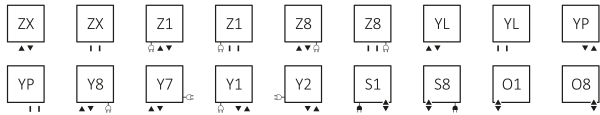

SADA OBSAHUJE:

Krytka otvorů a ALU-PEX nebo Cu trubek ze zdi, hranatá,
pro ventily na osu 50mm
2xkulatý krycí profil od zdi k ventilu, 50mm

Barva	Cena bez DPH u barev Premium +25% do barev RAL [EUR]	Kód produktu	Kód konfigurace
Chrom	24	TGPZMRP1	KCRO
Bílá	24	TGPZMRP1	K916
Černá Polomat	24	TGPZMRP1	K9M5
Černá	24	TGPZMRP1	K9P5
Bílá Mat	24	TGPZMRP1	KS96

Sada rohová regulační „Classic Art”

MOŽNOSTI BAREVNÝCH ÚPRAV:



PŘIPOJENÍ:

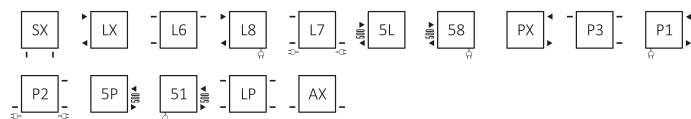

Velikost	Barva	Cena bez DPH [EUR]	Kód produktu ...Kód konfigurace s. 368
GZ 1/2" – Ø16x2, Ø15, GW 1/2"	Antracit	199	TGERANT01
GZ 1/2" – Ø16x2, Ø15, GW 1/2"	Bronz kartáčovaný	209	TGERANT03
GZ 1/2" – Ø16x2, Ø15, GW 1/2"	V barvě radiátoru (vzorník speciálních barev pro litinové radiátory a vzorník RAL)	210	WRZRRAW01...

Sada rohová regulační „Minimalist”

MOŽNOSTI BAREVNÝCH ÚPRAV:



PŘIPOJENÍ:

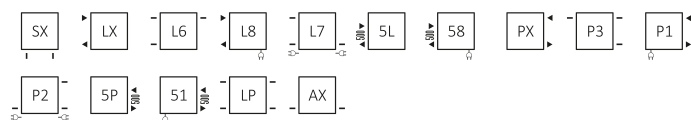

Velikost	Barva	Cena bez DPH [EUR]	Kód produktu ...Kód konfigurace s. 368
GZ 1/2" – Ø16x2, Ø15	Antracit	228	TGERAN002
GZ 1/2" – Ø16x2, Ø15	Bronz kartáčovaný	228	TGERBR002
GZ 1/2" – Ø16x2, Ø15	Měď kartáčovaná	228	TGERME003
GZ 1/2" – Ø16x2, Ø15	Nikl satén	228	TGERST005
GZ 1/2" – Ø16x2, Ø15	Chrom	228	TGZRCR017
GZ 1/2" – Ø16x2, Ø15	V barvě radiátoru (vzorník speciálních barev pro litinové radiátory a vzorník RAL)	228	WRZRRAW03...

Sada rohová termostatická „Artistic”

MOŽNOSTI BAREVNÝCH ÚPRAV:



PŘIPOJENÍ:

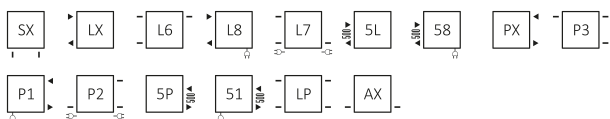

Velikost	Barva	Cena bez DPH [EUR]	Kód produktu <small>... Kód konfigurace s. 368</small>
GZ 1/2" – Ø16x2, Ø15	Antracit	190	TGETAN002
GZ 1/2" – Ø16x2, Ø15	Bronz kartáčovaný	190	TGETBR003
GZ 1/2" – Ø16x2, Ø15	V barvě radiátoru (vzorník speciálních barev pro litinové radiátory a vzorník RAL)	190	WRZTKAR01 ...

Sada rohová termostatická „Wood”

MOŽNOSTI BAREVNÝCH ÚPRAV:



PŘIPOJENÍ:

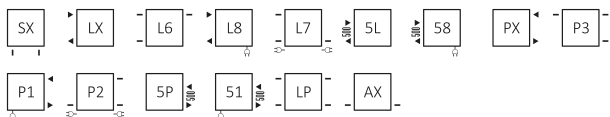

Velikost	Barva	Cena bez DPH [EUR]	Kód produktu
GZ 1/2" – Ø16x2, Ø15	Bronz kartáčovaný	209	TGETBR002
GZ 1/2" – Ø16x2, Ø15	Nikl satén	209	TGETST005
GZ 1/2" – Ø16x2, Ø15	Měď kartáčovaná	209	TGETME001

Sada krycí dvojitá „Artistic”

MOŽNOSTI BAREVNÝCH ÚPRAV:



Velikost	Barva	Cena bez DPH [EUR]	Kód produktu ... Kód konfigurace s. 368
Ø18/Ø50/L160	Antracit	64	TGPAN001
Ø18/Ø50/L160	Bronz kartáčovaný	52	TGPBR001
Ø18/Ø50/L160	V barvě radiátoru (vzorník speciálních barev pro litinové radiátory a vzorník RAL)	66	WRMRAW01...

Sada krycí dvojitá

MOŽNOSTI BAREVNÝCH ÚPRAV:

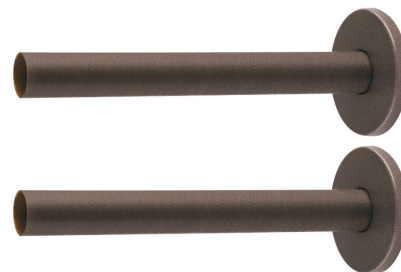
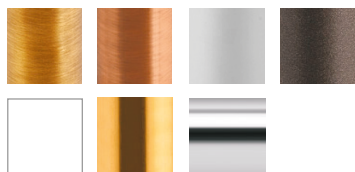

Velikost	Barva	Cena bez DPH [EUR]	Kód produktu ... Kód konfigurace s. 368
Ø18/Ø50/L160	Bronz kartáčovaný	44	TGPBR002
Ø18/Ø50/L160	Měď kartáčovaná	44	TGPME001
Ø18/Ø50/L160	Nikl satén	44	TGPNI001
Ø18/Ø50/L160	Antracit	41	TGPAN002
Ø18/Ø50/L160	Bílá	35	TGPBI001
Ø18/Ø50/L160	Mosaz	31	TGPMS001
Ø18/Ø50/L160	Chrom	33	TGPCR004
Ø18/Ø50/L160	Černá	35	TGPCZ001
Ø18/Ø50/L160	Černá Mat	34	TGPCM001
Ø18/Ø50/L160	Zlatá	50	TGPZL002
Ø18/Ø50/L160	V barvě radiátoru (vzorník speciálních barev pro litinové radiátory a vzorník RAL)	49	WRMRAW02...

Adaptér AL-PEX – 24 × 19

MOŽNOSTI BAREVNÝCH ÚPRAV:



Velikost	Barva	Cena bez DPH [EUR]	Kód produktu <small>... Kód konfigurace s. 368</small>
GW 24-19 – Ø16x2	Nikl satén	14	TGAST019
GW 24-19 – Ø16x2	Bronz kartáčovaný	14	TGABS006
GW 24-19 – Ø16x2	Antracit	14	TGAAN001
GW 24-19 – Ø16x2	Měď kartáčovaná	14	TGAME001
GW 24-19 – Ø16x2	Mosaz	14	TGAMS001
GW 24-19 – Ø16x2	V barvě radiátoru (vzorník speciálních barev pro litinové radiátory a vzorník RAL)	15	WRAADAP01...

Adaptér na ocel – 24 × 19

MOŽNOSTI BAREVNÝCH ÚPRAV:



Velikost	Barva	Cena bez DPH [EUR]	Kód produktu <small>... Kód konfigurace s. 368</small>
GW 24-19-GW 1/2"	Nikl satén	16	TGAST020
GW 24-19-GW 1/2"	Bronz kartáčovaný	16	TGABS005
GW 24-19-GW 1/2"	Antracit	16	TGAAN003
GW 24-19-GW 1/2"	Měď kartáčovaná	16	TGAME003
GW 24-19-GW 1/2"	Mosaz	16	TGAMS003
GW 24-19-GW 1/2"	V barvě radiátoru (vzorník speciálních barev pro litinové radiátory a vzorník RAL)	17	WRAADAP02...

Adaptér na měď – 24 × 19

MOŽNOSTI BAREVNÝCH ÚPRAV:



Velikost	Barva	Cena bez DPH [EUR]	Kód produktu <small>... Kód konfigurace s. 368</small>
GW 24-19 – Ø15	Nikl satén	14	TGAST018
GW 24-19 – Ø15	Bronz kartáčovaný	14	TGABS003
GW 24-19 – Ø15	Antracit	14	TGAAN002
GW 24-19 – Ø15	Měď kartáčovaná	14	TGAME002
GW 24-19 – Ø15	Mosaz	14	TGAMS002
GW 24-19 – Ø15	V barvě radiátoru (vzorník speciálních barev pro litinové radiátory a vzorník RAL)	15	WRAADAP03...

Odvzdušňovací ventil

MOŽNOSTI BAREVNÝCH ÚPRAV:

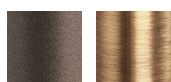

Velikost	Barva	Cena bez DPH [EUR]	Kód produktu <small>... Kód konfigurace s. 368</small>
1/2"	Antracit	9	MMEHYOD0008
1/2"	Bronz	9	MMEHYOD0009
1/2"	V barvě radiátoru (vzorník speciálních barev pro litinové radiátory a vzorník RAL)	10	PLVODP01...

Redukce 5/4" x 1/2"

V barvě vybraného radiátoru.



Velikost	Orientace	Cena bez DPH [EUR]	Kód produktu ...Kód konfigurace s. 368
5/4"	levá	4	PLVKOR-Z01...
5/4"	pravá	4	PLVKOR-Z02...

Zátka EUro 5/4"

V barvě vybraného radiátoru.



Velikost	Orientace	Cena bez DPH [EUR]	Kód produktu ...Kód konfigurace s. 368
5/4"	levá	4	PLVKOR-Z03...
5/4"	pravá	4	PLVKOR-Z04...

Vsuvka pro spojení článků 5/4"



Materiál	Cena bez DPH [EUR]	Kód produktu
Litina	2	MMECSGZ0011
Ocel	1	MMECSGZ0018

Těsnění pro litinový radiátor

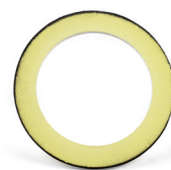

Velikost	Cena bez DPH [EUR]	Kód produktu
5/4"; tl. 1,5 mm	1	MTSININ0053

Montážní klíč na spojování článků



Velikost	Cena bez DPH [EUR]	Kód produktu
800 mm (10 článků po 80 mm)	143	WRNGZ600

Hák



Radiátor	Barva	Cena bez DPH [EUR]	Kód produktu <small>Kód konfigurace s. 368</small>
Oxford i Plain 3K	V barvě radiátoru (vzorník speciálních barev pro litinové radiátory a vzorník RAL)	11	PLV-HAK-220...
Plain i Kaszub	V barvě radiátoru (vzorník speciálních barev pro litinové radiátory a vzorník RAL)	11	PLV-HAK-180...
Bart	V barvě radiátoru (vzorník speciálních barev pro litinové radiátory a vzorník RAL)	11	PLV-HAK-070...

Ventily a příslušenství

Komplexní integrovaný termostatický ventil s ponornou trubicí

VENTIL ROHOVÝ - 90°

DOSTUPNÉ VERZE:



Levá



Pravá

NEZAPOMEŇTE KOUPIIT:

Adaptéry
Termostatická hlavice
Sada krycí



MOŽNOSTI BAREVNÝCH ÚPRAV:



Orientace	Velikost	Barva	Cena bez DPH [EUR]	Kód produktu
Levá	GZ 1/2" – GZ 3/4"	Bílá	99	TGZTBI008
Pravá	GZ 1/2" – GZ 3/4"	Bílá	99	TGZTBI009
Levá	GZ 1/2" – GZ 3/4"	Chrom	97	TGZTCR019
Pravá	GZ 1/2" – GZ 3/4"	Chrom	97	TGZTCR018
Levá	GZ 1/2" – GZ 3/4"	Satén	129	TGZTST017
Pravá	GZ 1/2" – GZ 3/4"	Satén	129	TGZTST016
Levá	GZ 1/2" – GZ 3/4"	Černá	99	TGZTCZ006
Pravá	GZ 1/2" – GZ 3/4"	Černá	99	TGZTCZ007
Levá	GZ 1/2" – GZ 3/4"	Černá Mat	129	TGZTCM006
Pravá	GZ 1/2" – GZ 3/4"	Černá Mat	129	TGZTCM007
Levá	GZ 1/2" – GZ 3/4"	Zlatá	177	TGZTZL001
Pravá	GZ 1/2" – GZ 3/4"	Zlatá	177	TGZTZL002

Komplexní integrovaný termostatický ventil přímý s ponornou

DOSTUPNÉ VERZE:

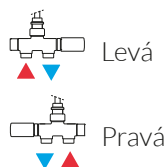

NEZAPOMEŇTE KOUPIT:

Adaptéry
Termostatická hlavice
Sada krycí



MOŽNOSTI BAREVNÝCH ÚPRAV:



Orientace	Velikost	Barva	Cena bez DPH [EUR]	Kód produktu
—	GZ 1/2" – GZ 3/4"	Bílá	100	TGZTBI010
—	GZ 1/2" – GZ 3/4"	Chrom	93	TGZTCR18
—	GZ 1/2" – GZ 3/4"	Satén	117	TGZTST018
—	GZ 1/2" – GZ 3/4"	Černá Mat	117	TGZTCM010

Komplexní integrovaný termostatický ventil

VENTIL ROHOVÝ - 90°

DOSTUPNÉ VERZE:



Levá



Pravá

NEZAPOMEŇTE KOUPIIT:

Adaptéry

Termostatická hlavice

Sada krycí



MOŽNOSTI BAREVNÝCH ÚPRAV:



Orientace	Velikost	Barva	Cena bez DPH [EUR]	Kód produktu
Levá	GZ 1/2" – GZ 24x19	Bílá	92	TGZTBI011
Pravá	GZ 1/2" – GZ 24x19	Bílá	92	TGZTBI012
Levá	GZ 1/2" – GZ 24x19	Chrom	90	TGZTCR005
Pravá	GZ 1/2" – GZ 24x19	Chrom	90	TGZTCR006
Levá	GZ 1/2" – GZ 24x19	Satén	112	TGZTST005
Pravá	GZ 1/2" – GZ 24x19	Satén	112	TGZTST006
Levá	GZ 1/2" – GZ 24x19	Černá	105	TGZTCZ001
Pravá	GZ 1/2" – GZ 24x19	Černá	105	TGZTCZ002
Levá	GZ 1/2" – GZ 24x19	Černá Mat	112	TGZTCM001
Pravá	GZ 1/2" – GZ 24x19	Černá Mat	112	TGZTCM002
Levá	GZ 1/2" – GZ 24x19	Zlatá	170	TGZTZL004
Pravá	GZ 1/2" – GZ 24x19	Zlatá	170	TGZTZL006

Komplexní integrovaný termostatický ventil přímý

DOSTUPNÉ VERZE:



Levá



Pravá

NEZAPOMEŇTE KOUPIIT:

Adaptéry
Termostatická hlavice
Sada krycí



MOŽNOSTI BAREVNÝCH ÚPRAV:



Orientace	Velikost	Barva	Cena bez DPH [EUR]	Kód produktu
Levá	GZ 1/2" – GZ 24x19	Bílá	94	TGZTBI019
Pravá	GZ 1/2" – GZ 24x19	Bílá	94	TGZTBI018
Levá	GZ 1/2" – GZ 24x19	Chrom	93	TGZTCR013
Pravá	GZ 1/2" – GZ 24x19	Chrom	93	TGZTCR014
Levá	GZ 1/2" – GZ 24x19	Satén	112	TGZTST012
Pravá	GZ 1/2" – GZ 24x19	Satén	112	TGZTST013
Levá	GZ 1/2" – GZ 24x19	Černá	108	TGZTCZ011
Pravá	GZ 1/2" – GZ 24x19	Černá	108	TGZTCZ010
Levá	GZ 1/2" – GZ 24x19	Černá Mat	112	TGZTCM011
Pravá	GZ 1/2" – GZ 24x19	Černá Mat	112	TGZTCM008

Komplexní integrovaný ventil s T- kusem s možností připojení topné tyče skrze ventil

VENTIL ROHOVÝ – 90°

DOSTUPNÉ VERZE (TOPNÁ TYČ SE MONTUJE NA VÝSTUPU):

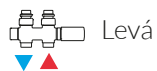

Levá



Pravá

NEZAPOMEŇTE KOUPIIT:

Adaptéry
Termostatická hlavice
Sada krycí



MOŽNOSTI BAREVNÝCH ÚPRAV:



Orientace	Velikost	Barva	Cena bez DPH [EUR]	Kód produktu
Levá	GZ 1/2" – GW 1/2" – GZ 24-19	Bílá	134	TGZTBI013
Pravá	GZ 1/2" – GW 1/2" – GZ 24-19	Bílá	134	TGZTBI014
Levá	GZ 1/2" – GW 1/2" – GZ 24-19	Chrom	128	TGZTCR022
Pravá	GZ 1/2" – GW 1/2" – GZ 24-19	Chrom	128	TGZTCR021
Levá	GZ 1/2" – GW 1/2" – GZ 24-19	Satén	162	TGZTST020
Pravá	GZ 1/2" – GW 1/2" – GZ 24-19	Satén	162	TGZTST021
Levá	GZ 1/2" – GW 1/2" – GZ 24-19	Černá	154	TGZTCZ008
Pravá	GZ 1/2" – GW 1/2" – GZ 24-19	Černá	154	TGZTCZ009
Levá	GZ 1/2" – GW 1/2" – GZ 24-19	Černá Mat	162	TGZTCM013
Pravá	GZ 1/2" – GW 1/2" – GZ 24-19	Černá Mat	162	TGZTCM009

Ventil tříosý uzavírací integrovaný s T- kusem pro připojení topné tyče skrze ventil

DOSTUPNÉ VERZE:

 Levá  Pravá

MOŽNOSTI BAREVNÝCH ÚPRAV:



NEZAPOMEŇTE KOUPIT:

Adaptéry
Sada krycí
Ventil tříosý termostatický
nebo regulační



Orientace	Velikost	Barva	Cena bez DPH [EUR]	Kód produktu
Levá	GZ 1/2" – GW 1/2" – GZ 24x19	Bílá	60	TGZOBI009
Pravá	GZ 1/2" – GW 1/2" – GZ 24x19	Bílá	60	TGZOBI010
Levá	GZ 1/2" – GW 1/2" – GZ 24x19	Chrom	56	TGZOCR010
Pravá	GZ 1/2" – GW 1/2" – GZ 24x19	Chrom	56	TGZOCR012
Levá	GZ 1/2" – GW 1/2" – GZ 24x19	Satén	68	TGZOST008
Pravá	GZ 1/2" – GW 1/2" – GZ 24x19	Satén	68	TGZOST010
Levá	GZ 1/2" – GW 1/2" – GZ 24x19	Černá	73	TGZOZ004
Pravá	GZ 1/2" – GW 1/2" – GZ 24x19	Černá	73	TGZOZ005
Levá	GZ 1/2" – GW 1/2" – GZ 24x19	Černá Mat	68	TGZOZCM004
Pravá	GZ 1/2" – GW 1/2" – GZ 24x19	Černá Mat	68	TGZOZCM005

Ventil integrovaný uzavírací (VK)

VENTIL ROHOVÝ - 90°

MOŽNOSTI BAREVNÝCH ÚPRAV:



NEZAPOMEŇTE
KOUPIŤ:

Adaptéry
Termostatická hlavice
Sada krycí



Velikost	Barva	Cena bez DPH [EUR]	Kód produktu
GW 3/4" (GZ 1/2") – GZ M22x1,5	Chrom	56	TGEOCR001
GW 3/4" (GZ 1/2") – GZ M22x1,5	Satén	69	TGEOST001
GW 3/4" (GZ 1/2") – GZ M22x1,5	Černá Mat	76	TGEOCM001

VENTIL PŘÍMÝ

MOŽNOSTI BAREVNÝCH ÚPRAV:



Velikost	Barva	Cena bez DPH [EUR]	Kód produktu
GW 3/4" (GZ 1/2") – GZ M22x1,5	Chrom	56	TGEOCR002
GW 3/4" (GZ 1/2") – GZ M22x1,5	Satén	69	TGEOST002
GW 3/4" (GZ 1/2") – GZ M22x1,5	Černá Mat	76	TGEOCM002

Ventil tříosý termostatický

DOSTUPNÉ VERZE:

 Levá  Pravá

MOŽNOSTI BAREVNÝCH ÚPRAV:



NEZAPOMEŇTE KOUPIIT:

Adaptéry
Termostatická hlavice
Sada krycí
Ventil tříosý uzavírací



Orientace	Velikost	Barva	Cena bez DPH [EUR]	Kód produktu
Levá	GZ 1/2" – GZ 24x19	Bílá	52	TGZTBI002
Pravá	GZ 1/2" – GZ 24x19	Bílá	52	TGZTBI003
Levá	GZ 1/2" – GZ 24x19	Chrom	52	TGZTCR002
Pravá	GZ 1/2" – GZ 24x19	Chrom	52	TGZTCR004
Levá	GZ 1/2" – GZ 24x19	Satén	66	TGZTST002
Pravá	GZ 1/2" – GZ 24x19	Satén	66	TGZTST004
Levá	GZ 1/2" – GZ 24x19	Černá	66	TGZTCZ003
Pravá	GZ 1/2" – GZ 24x19	Černá	66	TGZTCZ004
Levá	GZ 1/2" – GZ 24x19	Černá Mat	66	TGZTCM003
Pravá	GZ 1/2" – GZ 24x19	Černá Mat	66	TGZTCM004
Levá	GZ 1/2" – GZ 24x19	Zlatá	89	TGZTZL003
Pravá	GZ 1/2" – GZ 24x19	Zlatá	89	TGZTZL005

Ventil tříosý regulační

DOSTUPNÉ VERZE:

 Levá  Pravá

MOŽNOSTI BAREVNÝCH ÚPRAV:



NEZAPOMEŇTE KOUPIIT:

Adaptéry
Sada krycí
Ventil tříosý uzavírací



Orientace	Velikost	Barva	Cena bez DPH [EUR]	Kód produktu
Levá	GZ 1/2" – GZ 24x19	Bílá	51	TGZRBI002
Pravá	GZ 1/2" – GZ 24x19	Bílá	51	TGZRBI004
Levá	GZ 1/2" – GZ 24x19	Chrom	46	TGZRRC002
Pravá	GZ 1/2" – GZ 24x19	Chrom	46	TGZRRC004
Levá	GZ 1/2" – GZ 24x19	Satén	54	TGZRST002
Pravá	GZ 1/2" – GZ 24x19	Satén	54	TGZRST004
Levá	GZ 1/2" – GZ 24x19	Černá	58	TGZRZC002
Pravá	GZ 1/2" – GZ 24x19	Černá	58	TGZRZC003
Levá	GZ 1/2" – GZ 24x19	Černá Mat	54	TGZRZM002
Pravá	GZ 1/2" – GZ 24x19	Černá Mat	54	TGZRZM003
Levá	GZ 1/2" – GZ 24x19	Zlatá	77	TGZRZL003
Pravá	GZ 1/2" – GZ 24x19	Zlatá	77	TGZRZL004

Ventil tříosý uzavírací

DOSTUPNÉ VERZE:



Levá Pravá

MOŽNOSTI BAREVNÝCH ÚPRAV:



NEZAPOMEŇTE KOUPIT:

Adaptéry
Sada krycí
Ventil tříosý termostatický
nebo regulační



Orientace	Velikost	Barva	Cena bez DPH [EUR]	Kód produktu
Levá	GZ 1/2" – GZ 24x19	Bílá	51	TGZOBI002
Pravá	GZ 1/2" – GZ 24x19	Bílá	51	TGZOBI004
Levá	GZ 1/2" – GZ 24x19	Chrom	46	TGZO CR002
Pravá	GZ 1/2" – GZ 24x19	Chrom	46	TGZO CR004
Levá	GZ 1/2" – GZ 24x19	Satén	58	TGZO ST002
Pravá	GZ 1/2" – GZ 24x19	Satén	58	TGZO ST004
Levá	GZ 1/2" – GZ 24x19	Černá	58	TGZO CZ002
Pravá	GZ 1/2" – GZ 24x19	Černá	58	TGZO CZ003
Levá	GZ 1/2" – GZ 24x19	Černá Mat	58	TGZO CM002
Pravá	GZ 1/2" – GZ 24x19	Černá Mat	58	TGZO CM003
Levá	GZ 1/2" – GZ 24x19	Zlatá	76	TGZO ZL003
Pravá	GZ 1/2" – GZ 24x19	Zlatá	76	TGZO ZL001

Ventil rohový termostatický

MOŽNOSTI BAREVNÝCH ÚPRAV:



NEZAPOMEŇTE KOUPIT:

Adaptéry
Termostatická hlavice
Sada krycí
Ventil rohový uzavírací



Velikost	Barva	Cena bez DPH [EUR]	Kód produktu
GZ 1/2" – GZ 24x19	Bílá	50	TGZTBI005
GZ 1/2" – GZ 24x19	Chrom	49	TGZTCR009
GZ 1/2" – GZ 24x19	Satén	66	TGZTST009
GZ 1/2" – GZ 24x19	Černá	63	TGZTCZ005
GZ 1/2" – GZ 24x19	Černá Mat	66	TGZTCM005

Ventil rohový regulační

MOŽNOSTI BAREVNÝCH ÚPRAV: NEZAPOMEŇTE KOUPIŤ:



Adaptéry
Sada krycí
Ventil rohový uzavírací



Velikost	Barva	Cena bez DPH [EUR]	Kód produktu
GZ 1/2" – GZ 24x19	Bílá	46	TGZRBI006
GZ 1/2" – GZ 24x19	Chrom	46	TGZRRC006
GZ 1/2" – GZ 24x19	Satén	52	TGZRST006
GZ 1/2" – GZ 24x19	Černá	56	TGZRZC001
GZ 1/2" – GZ 24x19	Černá Mat	52	TGZRZCM001

Ventil rohový uzavírací

MOŽNOSTI BAREVNÝCH ÚPRAV: NEZAPOMEŇTE KOUPIŤ:



Adaptéry
Sada krycí
Ventil rohový termostatický
nebo regulační



Velikost	Barva	Cena bez DPH [EUR]	Kód produktu
GZ 1/2" – GZ 24x19	Bílá	46	TGZOBI006
GZ 1/2" – GZ 24x19	Chrom	46	TGZOZCR013
GZ 1/2" – GZ 24x19	Satén	52	TGZOZST006
GZ 1/2" – GZ 24x19	Černá	56	TGZOZCZ001
GZ 1/2" – GZ 24x19	Černá Mat	54	TGZOZCM001

Ventil termostatický přímý

MOŽNOSTI BAREVNÝCH ÚPRAV: NEZAPOMEŇTE KOUPIIT:



Adaptéry
Termostatická hlavice
Sada krycí
Ventil uzavírací přímý



Velikost	Barva	Cena bez DPH [EUR]	Kód produktu
GZ 1/2" – GZ 24x19	Bílá	50	TGZTBI006
GZ 1/2" – GZ 24x19	Chrom	49	TGZTCR015
GZ 1/2" – GZ 24x19	Satén	66	TGZTST019

Ventil regulační přímý

MOŽNOSTI BAREVNÝCH ÚPRAV: NEZAPOMEŇTE KOUPIIT:



Adaptéry
Sada krycí
Ventil uzavírací přímý



Velikost	Barva	Cena bez DPH [EUR]	Kód produktu
GZ 1/2" – GZ 24x19	Bílá	46	TGZRBI007
GZ 1/2" – GZ 24x19	Chrom	46	TGZRRC009
GZ 1/2" – GZ 24x19	Satén	52	TGZRST007

Ventil uzavírací přímý

MOŽNOSTI BAREVNÝCH ÚPRAV: NEZAPOMEŇTE KOUPIIT:



Adaptéry
Sada krycí
Ventil termostatický přímý
nebo regulační přímý



Velikost	Barva	Cena bez DPH [EUR]	Kód produktu
GZ 1/2" – GZ 24x19	Bílá	46	TGZOBI007
GZ 1/2" – GZ 24x19	Chrom	46	TGZOCR008
GZ 1/2" – GZ 24x19	Satén	54	TGZOST012

T- kus

MOŽNOSTI BAREVNÝCH ÚPRAV:



Velikost	Barva	Cena bez DPH [EUR]	Kód produktu
GZ 1/2" – GW 1/2" – GW 1/2"	Bílá	7	WRT1C2 916
GZ 1/2" – GW 1/2" – GW 1/2"	Chrom	8	WRT1C2 CRO
GZ 1/2" – GW 1/2" – GW 1/2"	Satén	7	WRT1C2 SMA
GZ 1/2" – GW 1/2" – GW 1/2"	Černá Polomat	7	WRT1C2 9M5
GZ 1/2" – GW 1/2" – GW 1/2"	Zlatá	16	TGI010

Ventil regulační rohový Minimalist – 24 × 19



Velikost	Barva	Cena bez DPH [EUR]	Kód produktu
GZ 1/2" – GZ 24x19	Zlatá	139	TGZRZL010

Ventil regulační rohový Star – 24 × 19



Velikost	Barva	Cena bez DPH [EUR]	Kód produktu
GZ 1/2" – GZ 24x19	Zlatá	119	TGZRZL002

Adaptér AL-PEX (šroubení) – 24 × 19

MOŽNOSTI BAREVNÝCH ÚPRAV:



Velikost	Barva	Cena bez DPH [EUR]	Kód produktu
GW 24x19 – Ø16x2	Chrom	9	TGACR019
GW 24x19 – Ø16x2	Satén	12	TGAST017
GW 24x19 – Ø16x2	Černá	13	TGACZ001
GW 24x19 – Ø16x2	Černá Mat	12	TGACM001
GW 24x19 – Ø16x2	Bílá	13	TGABI001
GW 24x19 – Ø16x2	Zlatá	27	TGAZL002

Určený pro ventily se závitem 24x19

Adaptér AL-PEX – 3/4"

Určený pro Komplexní integrovaný termostatický ventil s ponornou trubicí.

MOŽNOSTI BAREVNÝCH ÚPRAV:



Velikost	Barva	Cena bez DPH [EUR]	Kód produktu
GW 3/4" – Ø16x2	Chrom	9	TGACR015
GW 3/4" – Ø16x2	Satén	12	TGAST015
GW 3/4" – Ø16x2	Černá	13	TGACZ005
GW 3/4" – Ø16x2	Černá Mat	12	TGACM002
GW 3/4" – Ø16x2	Bílá	13	TGABI002
GW 3/4" – Ø16x2	Zlatá	27	TGAZL001

Adaptér AL-PEX – M22 × 1,5

Určený pro Ventil integrovaný uzavírací.

MOŽNOSTI BAREVNÝCH ÚPRAV:



Velikost	Barva	Cena bez DPH [EUR]	Kód produktu
GW M22x1,5 – Ø16x2	Chrom	9	TGACR011
GW M22x1,5 – Ø16x2	Satén	12	TGAST011
GW M22x1,5 – Ø16x2	Černá Mat	12	TGACM003

Adaptér (šroubení) na měď – 24 × 19

Určený pro ventily se závitem 24x19.

MOŽNOSTI BAREVNÝCH ÚPRAV:



Velikost	Barva	Cena bez DPH [EUR]	Kód produktu
GW 24x19 – Ø15	Chrom	9	TGACR003
GW 24x19 – Ø15	Satén	12	TGAST003
GW 24x19 – Ø15	Bílá	13	TGABI003
GW 24x19 – Ø15	Zlatá	24	TGAZL003

Pokud potřebujete adaptér na měď v barvě Černá nebo Černá Mat objednejte Adaptér na AL-PEX 24 x 19 v dané barvě obsahující matici v dané barvě + šroubení na měď - Kód produktu TGAZU001 v ceně 2x2 EUR bez DPH **viz stránka 318**

Adaptér (šroubení) na měď – 3/4"

Určený pro Komplexní integrovaný termostatický ventil s ponornou trubicí.

MOŽNOSTI BAREVNÝCH ÚPRAV:



Velikost	Barva	Cena bez DPH [EUR]	Kód produktu
GW 3/4" – Ø15	Chrom	9	TGACR018
GW 3/4" – Ø15	Satén	12	TGAST014

Pokud potřebujete adaptér na měď v barvě Bílá, Černá, Zlatá nebo Černá Mat objednejte Adaptér na AL-PEX 3/4" v dané barvě obsahující matici v dané barvě + šroubení na měď - Kód produktu TGAZU002 v ceně 2x2 EUR bez DPH [viz stránka 318](#)

Adaptér na měď – M22 × 1,5

Určený pro Ventil integrovaný uzavírací.

MOŽNOSTI BAREVNÝCH ÚPRAV:



Velikost	Barva	Cena bez DPH [EUR]	Kód produktu
GW M22x1,5 – Ø15	Chrom	9	TGACR006
GW M22x1,5 – Ø15	Satén	12	TGAST006
GW M22x1,5 – Ø15	Černá Mat	12	TGACM004

Adaptér (šroubení) na ocel – 24 × 19

Určený pro ventily se závitem 24x19.

MOŽNOSTI BAREVNÝCH ÚPRAV:



Velikost	Barva	Cena bez DPH [EUR]	Kód produktu
GW 24x19 – GW 1/2"	Chrom	12	TGACR007
GW 24x19 – GW 1/2"	Satén	14	TGAST007

Adaptér na ocel – M22 × 1,5

Určený pro Ventil integrovaný uzavírací.

MOŽNOSTI BAREVNÝCH ÚPRAV:



Velikost	Barva	Cena bez DPH [EUR]	Kód produktu
GW M22x1,5 – GW 1/2"	Chrom	12	TGACR012
GW M22x1,5 – GW 1/2"	Satén	14	TGAST012

Termostatická hlavice ETNA

MOŽNOSTI BAREVNÝCH ÚPRAV:



Velikost	Barva	Cena bez DPH [EUR]	Kód produktu
M30x1,5	Bílá	22	TGGBI002
M30x1,5	Chrom	34	TGGCR002

Termostatická hlavice NOBLE

MOŽNOSTI BAREVNÝCH ÚPRAV:



Velikost	Barva	Cena bez DPH [EUR]	Kód produktu
M30x1,5	Bílá	27	TGGBI007
M30x1,5	Chrom	34	TGGCR004
M30x1,5	Satén	43	TGGST002
M30x1,5	Černá	37	TGGCZ001
M30x1,5	Černá Mat	43	TGGCM002

Termostatická hlavice SLIM

MOŽNOSTI BAREVNÝCH ÚPRAV:



Velikost	Barva	Cena bez DPH [EUR]	Kód produktu
M30x1,5	Bílá	37	TGGBI001
M30x1,5	Chrom	38	TGGCR001
M30x1,5	Satén	63	TGGST001
M30x1,5	Černá	56	TGGCZ002
M30x1,5	Černá Mat	63	TGGCM001
M30x1,5	Zlatá	73	TGGZL001

Zátka (7mm vystupující z otvoru)

MOŽNOSTI BAREVNÝCH ÚPRAV:



Velikost	Barva	Cena bez DPH [EUR]	Kód produktu
GZ 1/2"	Chrom	5	MMEHYKR0001
GZ 1/2"	Satén	5	TGIKST001

Zátka schovaná v otvoru (jen 3mm vystupující)

MOŽNOSTI BAREVNÝCH ÚPRAV:

vzorník RAL, Speciálních barev, barev Premium, Chrom



Velikost	Barva	Cena bez DPH [EUR]	Kód produktu
GZ 1/2"	Bílá	6	WRZK001-BI
GZ 1/2"	Chrom	6	WRZK001-CR

Distanční matice

MOŽNOSTI BAREVNÝCH ÚPRAV:



Velikost 1/2" Velikost 24x19

Velikost	Barva	Cena bez DPH [EUR]	Kód produktu
GW 1/2" – GZ 1/2"	Chrom	6	TGUCR001
GW 1/2" – GZ 1/2"	Satén	8	TGUST001
GW 24x19 – GZ 24x19	Chrom	6	TGUCR002
GW 24x19 – GZ 24x19	Satén	8	TGUST002

Odvzdušňovací ventil

MOŽNOSTI BAREVNÝCH ÚPRAV:

vzorník RAL, Speciálních barev, barev Premium, Chrom



Velikost 1/4"



Velikost	Barva	Cena bez DPH [EUR]	Kód produktu
GZ 1/2"	Bílá	7	WRZ0001-BI
GZ 1/2"	Chrom	6	WRZ0001-CR
GZ 1/4"	Nikl	9	MMEHYOD0005

Sada krycí dvojité

MOŽNOSTI BAREVNÝCH ÚPRAV:



Velikost	Barva	Cena bez DPH [EUR]	Kód produktu
Ø18/Ø55/L160 mm	Bílá	35	TGPBI001
Ø18/Ø55/L70 mm	Chrom	27	TGPCR001
Ø18/Ø55/L70 mm	Satén	34	TGPST001
Ø18/Ø55/L160 mm	Černá	35	TGPCZ001
Ø18/Ø55/L160 mm	Černá Mat	34	TGPCM001
Ø18/Ø55/L160 mm	Chrom	33	TGPCR004
Ø18/Ø55/L160 mm	Zlatá	50	TGPZL002

Sada krycí integrovaná

MOŽNOSTI BAREVNÝCH ÚPRAV:

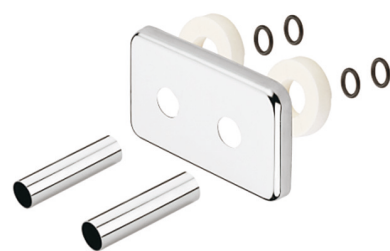

Velikost	Barva	Cena bez DPH [EUR]	Kód produktu
Ø18/ rozteč 50 mm; L70mm	Bílá	51	TGPBI005
Ø18/ rozteč 50 mm; L70mm	Chrom	38	TGPCR002
Ø18/ rozteč 50 mm; L70mm	Satén	51	TGPST003
Ø18/ rozteč 50 mm; L70mm	Černá	51	TGPCZ002
Ø18/ rozteč 50 mm; L70mm	Černá Mat	51	TGPCM002
Ø18/ rozteč 50 mm; L70mm	Zlatá	62	TGPZL001

Sada speciálních klíčů TERMA

Klíče pasují pro montáž TERMA příslušenství a topných tyčí.

TYP:

Plochý oboustranný

VELIKOST:

20-22, 22-24, 26-27, 27-28



Velikost	Cena bez DPH [EUR]	Kód produktu
20-22, 22-24, 26-27, 27-28	57	WRNKPS0001

Prodlužovací trubice

Pro připojení ventilů k ústřednímu vytápění s výstupem GW 1/2"



Velikost	Barva	Cena bez DPH [EUR]	Kód produktu
GZ 1/2" x Ø15 x 150mm	Chrom	7	TGUMS004

Čistící kartáč dlouhý

Materiál: buk a přírodní žíně.



Velikost	Cena bez DPH [EUR]	Kód produktu
1000 mm	19	TGI007

Čistící kartáč Ribbon

Materiál: buk a přírodní žíně.



Velikost	Cena bez DPH [EUR]	Kód produktu
-	19	TGI009

Sanitární příslušenství

Madlo rovné

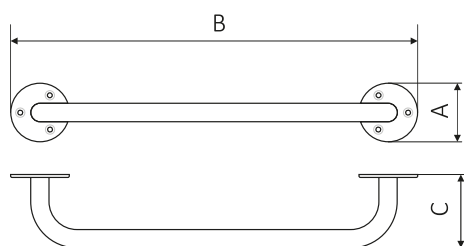

SPECIFIKACE:

A ↕	B ↔	C [mm]	Profil [mm]	Bílá Cena bez DPH [EUR]	Barva ze vzorníku RAL a speciálních barev Cena bez DPH [EUR]	Chrom Cena bez DPH [EUR]	Kód produktu Kód konfigurace s. 368
80	555	100	Ø 25	41	46	50	WBPPX001...
80	655	100	Ø 25	42	46	51	WBPPX003 ...
80	755	100	Ø 25	42	47	53	WBPPX005 ...
80	855	100	Ø 25	43	47	54	WBPPX007 ...

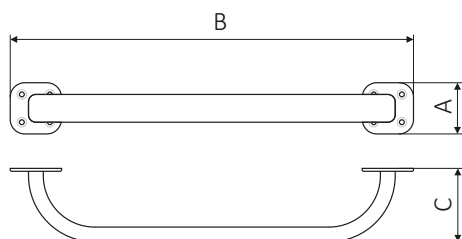

SPECIFIKACE:

A ↕	B ↔	C [mm]	Profil [mm]	Bílá Cena bez DPH [EUR]	Barva ze vzorníku RAL a speciálních barev Cena bez DPH [EUR]	Chrom Cena bez DPH [EUR]	Kód produktu Kód konfigurace s. 368
70	550	100	38x20	43	48	54	WBPPX002 ...
70	650	100	38x20	44	49	56	WBPPX004 ...
70	750	100	38x20	45	50	58	WBPPX006 ...
70	850	100	38x20	46	51	60	WBPPX008 ...

Madlo pravoúhlé 90°

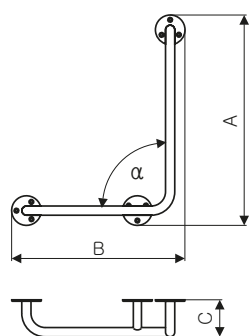

• Obrázek ukazuje levou verzi.



SPECIFIKACE:

A ⇕	B ↔	C [mm]	Profil [mm]	Bílá Cena bez DPH [EUR]	Barva ze vzorníku RAL a speciálních barev Cena bez DPH [EUR]	Chrom Cena bez DPH [EUR]	Kód produktu Kód konfigurace s. 368	Verze
505	405	100	∅ 25	48	54	61	WBPSL003 ...	levá
705	505	100	∅ 25	52	59	65	WBPSL007 ...	levá
505	405	100	∅ 25	48	54	61	WBPSP003 ...	pravá
705	505	100	∅ 25	52	59	65	WBPSP007 ...	pravá

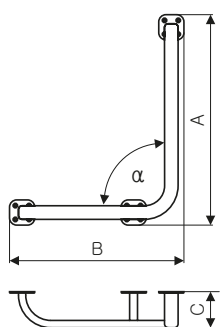

• Obrázek ukazuje levou verzi.



SPECIFIKACE:

A ⇕	B ↔	C [mm]	Profil [mm]	Bílá Cena bez DPH [EUR]	Barva ze vzorníku RAL a speciálních barev Cena bez DPH [EUR]	Chrom Cena bez DPH [EUR]	Kód produktu Kód konfigurace s. 368	Verze
500	400	100	38x20	56	64	72	WBPSL004 ...	levá
700	500	100	38x20	57	65	77	WBPSL008 ...	levá
500	400	100	38x20	56	64	72	WBPSP004 ...	pravá
700	500	100	38x20	57	65	77	WBPSP008 ...	pravá

Madlo pravoúhlé 125°

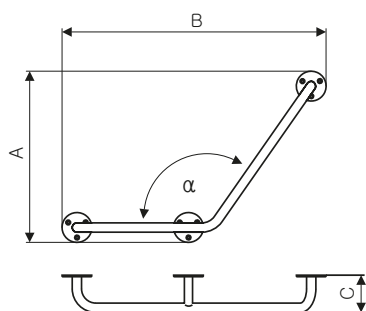

• Obrázek ukazuje levou verzi.



SPECIFIKACE:

A ↕	B ↔	C (mm)	Profil (mm)	Bílá Cena bez DPH [EUR]	Barva ze vzorníku RAL a speciálních barev Cena bez DPH [EUR]	Chrom Cena bez DPH [EUR]	Kód produktu Kód konfigurace s. 368	Verze
460	710	100	Ø 25	49	55	63	WBPSL001 ...	levá
624	925	100	Ø 25	53	60	68	WBPSL005 ...	levá
460	710	100	Ø 25	49	55	63	WBPSP001 ...	pravá
624	925	100	Ø 25	53	60	68	WBPSP005 ...	pravá

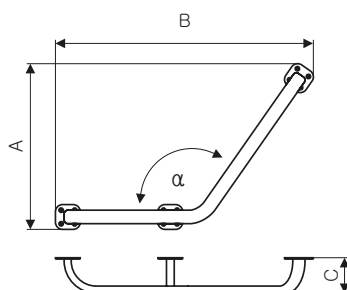

• Obrázek ukazuje levou verzi.



SPECIFIKACE:

A ↕	B ↔	C (mm)	Profil (mm)	Bílá Cena bez DPH [EUR]	Barva ze vzorníku RAL a speciálních barev Cena bez DPH [EUR]	Chrom Cena bez DPH [EUR]	Kód produktu Kód konfigurace s. 368	Verze
475	742	100	38x20	57	65	71	WBPSL002 ...	levá
639	957	100	38x20	58	66	80	WBPSL006 ...	levá
475	742	100	38x20	57	65	71	WBPSP002 ...	pravá
639	957	100	38x20	58	66	80	WBPSP006 ...	pravá

Madlo vodorovné

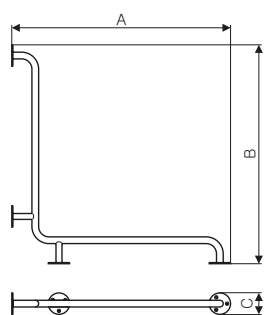

SPECIFIKACE:

A ↓	B ↔	C [mm]	Profil [mm]	Bílá Cena bez DPH [EUR]	Barva ze vzorníku RAL a speciálních barev Cena bez DPH [EUR]	Chrom Cena bez DPH [EUR]	Kód produktu Kód konfigurace s. 368
778	778	80	Ø 25	62	72	78	WBPLX001 ...
778	978	80	Ø 25	64	74	80	WBPLX003 ...

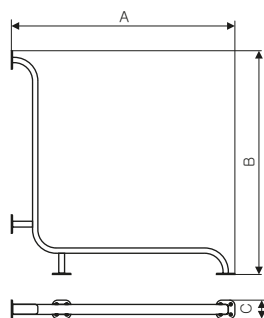

SPECIFIKACE:

A ↓	B ↔	C [mm]	Profil [mm]	Bílá Cena bez DPH [EUR]	Barva ze vzorníku RAL a speciálních barev Cena bez DPH [EUR]	Chrom Cena bez DPH [EUR]	Kód produktu Kód konfigurace s. 368
775	775	70	38x20	70	82	89	WBPLX002 ...
775	975	70	38x20	72	85	93	WBPLX004 ...

Opěrné madlo svislé

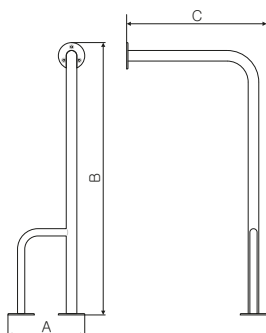

• Obrázek ukazuje levou verzi.



SPECIFIKACE:

A ⇕	B ↔	C [mm]	Profil [mm]	Bílá Cena bez DPH [EUR]	Barva ze vzorníku RAL a speciálních barev Cena bez DPH [EUR]	Chrom Cena bez DPH [EUR]	Kód produktu Kód konfigurace s. 368	Verze
235	824	424	Ø 32	57	65	77	WBWIL001 ...	levá
235	824	824	Ø 32	63	72	80	WBWIL003 ...	levá
235	824	424	Ø 32	57	65	77	WBWIP001 ...	pravá
235	824	824	Ø 32	63	72	80	WBWIP003 ...	pravá

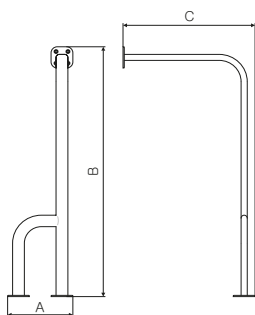

• Obrázek ukazuje levou verzi.



SPECIFIKACE:

A ⇕	B ↔	C [mm]	Profil [mm]	Bílá Cena bez DPH [EUR]	Barva ze vzorníku RAL a speciálních barev Cena bez DPH [EUR]	Chrom Cena bez DPH [EUR]	Kód produktu Kód konfigurace s. 368	Verze
210	825	425	38x20	58	66	79	WBWIL002 ...	levá
210	825	825	38x20	59	68	83	WBWIL004 ...	levá
210	825	425	38x20	58	66	79	WBWIP002 ...	pravá
210	825	825	38x20	59	68	83	WBWIP004 ...	pravá

Opěrné madlo vodorovné

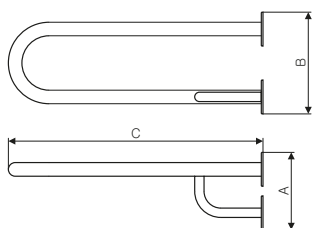

• Obrázek ukazuje levou verzi.

SPECIFIKACE:

A ↓	B ↔	C [mm]	Profil [mm]	Bílá Cena bez DPH [EUR]	Barva ze vzorníku RAL a speciálních barev Cena bez DPH [EUR]	Chrom Cena bez DPH [EUR]	Kód produktu Kód konfigurace s. 368	Verze
180	240	600	Ø 32	57	65	71	WBWOL001 ...	levá
180	240	700	Ø 32	58	67	81	WBWOL003 ...	levá
180	240	600	Ø 32	57	65	71	WBWOP001 ...	pravá
180	240	700	Ø 32	58	67	81	WBWOP003 ...	pravá

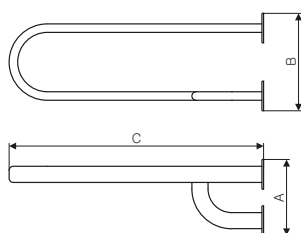

• Obrázek ukazuje levou verzi.

SPECIFIKACE:

A ↓	B ↔	C [mm]	Profil [mm]	Bílá Cena bez DPH [EUR]	Barva ze vzorníku RAL a speciálních barev Cena bez DPH [EUR]	Chrom Cena bez DPH [EUR]	Kód produktu Kód konfigurace s. 368	Verze
180	230	600	38x20	57	66	79	WBWOL002 ...	levá
180	230	700	38x20	59	68	83	WBWOL004 ...	levá
180	230	600	38x20	57	66	79	WBWOP002 ...	pravá
180	230	700	38x20	59	68	83	WBWOP004 ...	pravá

Opěrné madlo volně stojící

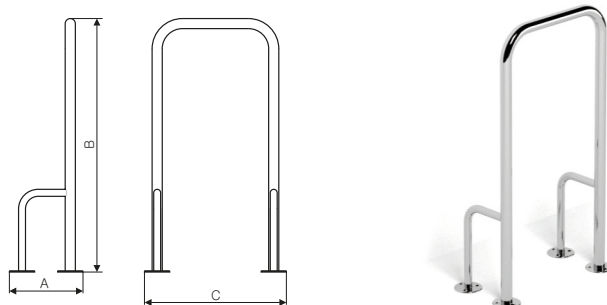

SPECIFIKACE:

A ⇕	B ↔	C [mm]	Profil [mm]	Bílá Cena bez DPH [EUR]	Barva ze vzorníku RAL a speciálních barev Cena bez DPH [EUR]	Chrom Cena bez DPH [EUR]	Kód produktu Kód konfigurace s. 368
235	800	448	Ø 32	75	88	95	WBWWX001 ...
235	800	748	Ø 32	76	89	99	WBWWX003 ...

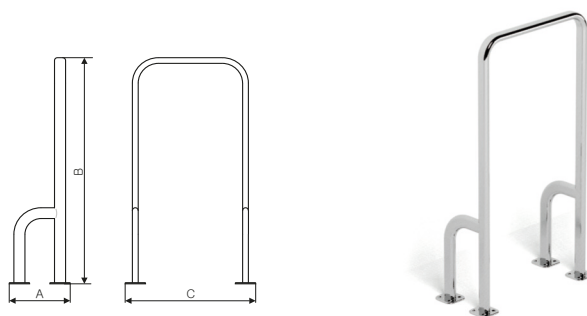

SPECIFIKACE:

A ⇕	B ↔	C [mm]	Profil [mm]	Bílá Cena bez DPH [EUR]	Barva ze vzorníku RAL a speciálních barev Cena bez DPH [EUR]	Chrom Cena bez DPH [EUR]	Kód produktu Kód konfigurace s. 368
210	800	450	38x20	78	91	110	WBWWX002 ...
210	800	750	38x20	79	93	115	WBWWX004 ...

Madlo nástěnné

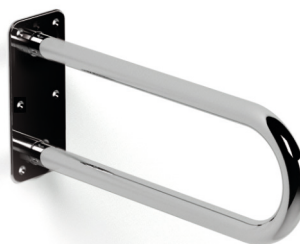
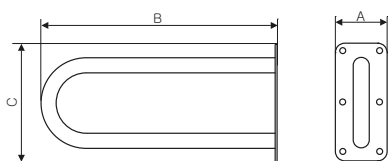

Výrobek je vhodný pro podomítkové rámy firmy TECE s deskou 9.042.013

SPECIFIKACE:

A ↕	B ↔	C [mm]	Profil [mm]	Bílá Cena bez DPH [EUR]	Barva ze vzorníku RAL a speciálních barev Cena bez DPH [EUR]	Chrom Cena bez DPH [EUR]	Kód produktu Kód konfigurace s. 368
90	500	275	Ø 32	48	54	68	WBUSX001 ...
90	600	275	Ø 32	49	55	70	WBUSX003 ...
90	700	275	Ø 32	50	57	78	WBUSX005 ...
90	800	275	Ø 32	51	58	81	WBUSX007 ...

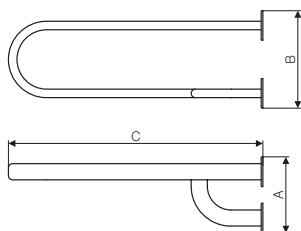

Výrobek je vhodný pro podomítkové rámy firmy TECE s deskou 9.042.013

SPECIFIKACE:

A ↕	B ↔	C [mm]	Profil [mm]	Bílá Cena bez DPH [EUR]	Barva ze vzorníku RAL a speciálních barev Cena bez DPH [EUR]	Chrom Cena bez DPH [EUR]	Kód produktu Kód konfigurace s. 368
90	500	275	38x20	50	56	74	WBUSX002 ...
90	600	275	38x20	51	58	77	WBUSX004 ...
90	700	275	38x20	52	59	80	WBUSX006 ...
90	800	275	38x20	53	61	83	WBUSX008 ...

Madlo nástěnné s držákem

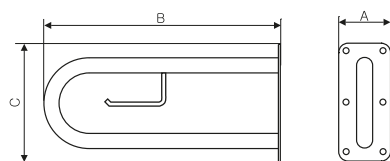

Výrobek je vhodný pro podomítkové rámy
firmy TECE s deskou 9.042.013

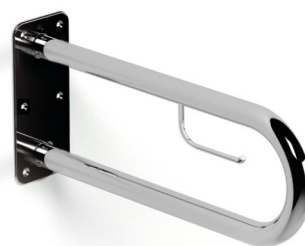

SPECIFIKACE:

A ⇕	B ↔	C (mm)	Profil (mm)	Bílá Cena bez DPH [EUR]	Barva ze vzorníku RAL a speciálních barev Cena bez DPH [EUR]	Chrom Cena bez DPH [EUR]	Kód produktu Kód konfigurace s. 368
90	500	275	Ø 32	52	59	64	WBUSR001 ...
90	600	275	Ø 32	53	61	70	WBUSR002 ...
90	700	275	Ø 32	54	62	72	WBUSR003 ...
90	800	275	Ø 32	55	63	74	WBUSR004 ...

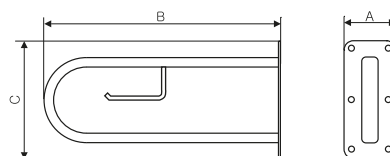

Výrobek je vhodný pro podomítkové rámy
firmy TECE s deskou 9.042.013



SPECIFIKACE:

A ⇕	B ↔	C (mm)	Profil (mm)	Bílá Cena bez DPH [EUR]	Barva ze vzorníku RAL a speciálních barev Cena bez DPH [EUR]	Chrom Cena bez DPH [EUR]	Kód produktu Kód konfigurace s. 368
90	500	275	38x20	54	62	73	WBUSR005 ...
90	600	275	38x20	56	64	78	WBUSR006 ...
90	700	275	38x20	57	65	81	WBUSR007 ...
90	800	275	38x20	58	66	85	WBUSR008 ...

Madlo sklopné

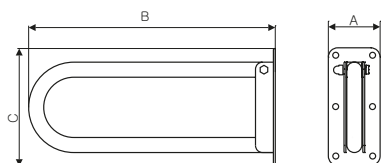

Výrobek je vhodný pro podomítkové rámy
firmy TECE s deskou 9.042.013

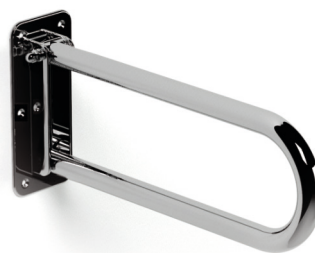

SPECIFIKACE:

A ↕	B ↔	C (mm)	Profil (mm)	Bílá Cena bez DPH [EUR]	Barva ze vzorníku RAL a speciálních barev Cena bez DPH [EUR]	Chrom Cena bez DPH [EUR]	Kód produktu Kód konfigurace s. 368
90	500	275	Ø 32	60	69	78	WBUPX001 ...
90	600	275	Ø 32	61	70	81	WBUPX003 ...
90	700	275	Ø 32	62	71	84	WBUPX005 ...
90	800	275	Ø 32	63	73	87	WBUPX007 ...

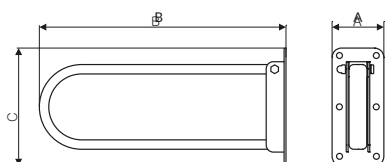

Výrobek je vhodný pro podomítkové rámy
firmy TECE s deskou 9.042.013

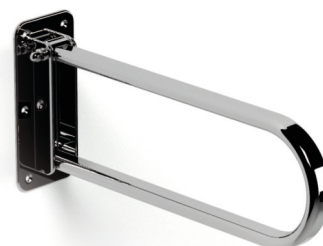

SPECIFIKACE:

A ↕	B ↔	C (mm)	Profil (mm)	Bílá Cena bez DPH [EUR]	Barva ze vzorníku RAL a speciálních barev Cena bez DPH [EUR]	Chrom Cena bez DPH [EUR]	Kód produktu Kód konfigurace s. 368
90	500	275	38x20	61	70	78	WBUPX002 ...
90	600	275	38x20	63	72	81	WBUPX004 ...
90	700	275	38x20	64	74	92	WBUPX006 ...
90	800	275	38x20	65	75	96	WBUPX008 ...

Madlo sklopné s držákom

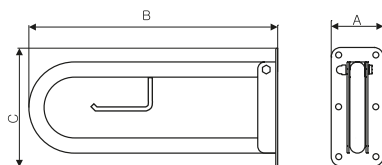

Výrobek je vhodný pro podomítkové rámy firmy TECE s deskou 9.042.013

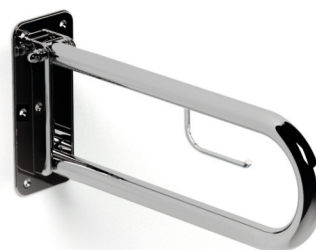

SPECIFIKACE:

A ⇕	B ↔	C [mm]	Profil [mm]	Bílá Cena bez DPH [EUR]	Barva ze vzorníku RAL a speciálních barev Cena bez DPH [EUR]	Chrom Cena bez DPH [EUR]	Kód produktu Kód konfigurace s. 368
90	500	275	Ø 32	63	73	87	WBUPR001 ...
90	600	275	Ø 32	64	75	90	WBUPR002 ...
90	700	275	Ø 32	66	76	96	WBUPR003 ...
90	800	275	Ø 32	66	77	95	WBUPR004 ...

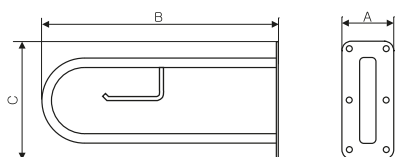

Výrobek je vhodný pro podomítkové rámy firmy TECE s deskou 9.042.013

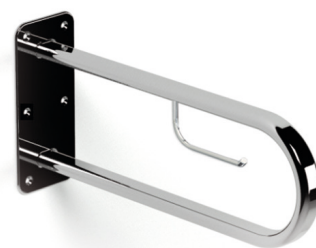

SPECIFIKACE:

A ⇕	B ↔	C [mm]	Profil [mm]	Bílá Cena bez DPH [EUR]	Barva ze vzorníku RAL a speciálních barev Cena bez DPH [EUR]	Chrom Cena bez DPH [EUR]	Kód produktu Kód konfigurace s. 368
90	500	275	38x20	65	75	87	WBUPR005 ...
90	600	275	38x20	66	77	91	WBUPR006 ...
90	700	275	38x20	67	78	95	WBUPR007 ...
90	800	275	38x20	68	80	98	WBUPR008 ...

Sprchové sedátko DIS

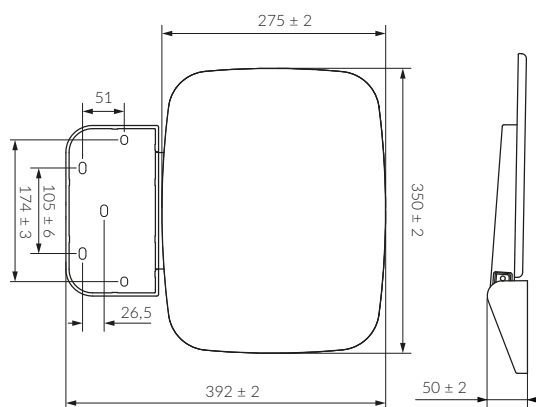

Sprchové sedátko DIS je pohodlné řešení, které vám umožní pohodlně používat sprchu a užít si příjemnou relaxaci po náročném dni.

Je vyrobeno z odolného materiálu Duroplast odolného proti poškrábání, který se používá i při výrobě kvalitních WC sedátek. Díky možnosti sklopení moc místa nezabere - po sklopení má hloubku jen 52 mm od stěny. Použité materiály a jednoduchá konstrukce umožňují udržovat sedátko v čistotě.



Výrobek je dostupný v bílé barvě s chromovaným plastovým krytem montážního držáku nebo v černé barvě. Montážní sada Fischer, která je součástí sady, zajistí vysokou odolnost při zatížení (doporučené maximální zatížení je 130 kg).

Výrobek je ideální pro každý sprchový kout.

Sedačka byla testována v souladu s požadavky EN 12520: 2016 a EN 1728: 2012 v laboratoři Certifikačního orgánu TÜV Rheinland.

Doporučená montážní výška sedáku: cca 40–45 cm od podlahy nebo od úrovně sprchové vaničky

SPECIFIKACE:

Rozměry [mm]	Hloubka [mm]	Hloubka po sklopení [mm]	Barva	Váha  [kg]	Maximální doporučené zatížení  [kg]	Cena bez DPH [EUR]	Kód produktu
350	392	52	bílá s chromem	2,75	130	105	TGSBI001
350	392	52	černá	2,75	130	110	TGSCZ001

Hygienický Atest pro Sanitární příslušenství



NARODOWY INSTYTUT ZDROWIA PUBLICZNEGO - Państwowy Zakład Higieny
NATIONAL INSTITUTE OF PUBLIC HEALTH - National Institute of Hygiene

ZAKŁAD BEZPIECZEŃSTWA ZDROWOTNEGO ŚRODOWISKA
DEPARTMENT OF ENVIRONMENTAL HEALTH AND SAFETY

ATEST HIGIENICZNY

B-BK-60210-0783/20

HYGIENIC CERTIFICATE

ORYGINAŁ

NATIONAL INSTITUTE OF PUBLIC HEALTH – NATIONAL INSTITUTE OF HYGIENE

Wyrób / product: **System uchwytów oraz poręczy dla osób niepełnosprawnych do eksploatacji w warunkach domowych, placówkach opieki zdrowotnej, toaletach publicznych i innych obiektach, z serii: PPX, PSL, PSP, PLX, WIL, WIP, WOL, WOP, WWX, USX, UPX**

Zawierający / containing: profile stalowe z powłoką chromową

Przeznaczony do / destined: wspomagania przemieszczania się oraz zwiększania bezpieczeństwa osób z niepełnosprawnością w pomieszczeniach sanitarnych

Wymieniony wyżej produkt odpowiada wymaganiom higienicznym przy spełnieniu następujących warunków / the above-named product is acceptable according to hygienic criteria with the following conditions:

W przypadku stosowania w obiektach służby zdrowia wyrób musi spełniać wymagania rozporządzenia Ministra Zdrowia z dnia 26 marca 2019 r. (Dz. U. Poz. 595 z 29 marca 2019 r.) w sprawie szczegółowych wymagań, jakim powinny odpowiadać pod względem fachowym i sanitarnym pomieszczenia i urządzenia podmiotu wykonującego działalność leczniczą.

Atest higieniczny nie dotyczy parametrów technicznych wyrobów/The hygienic certificate does not apply to technical parameters of the products.

Wytwórca / producer:

TERMA Sp. z o.o.
80-298 Gdańsk
Czaple 100

Niniejszy dokument wydano na wniosek / this certificate issued for:

TERMA Sp. z o.o.
80-298 Gdańsk
Czaple 100

Atest może być zmieniony lub unieważniony po przedstawieniu stosownych dowodów przez którąkolwiek stronę. Niniejszy atest traci ważność po 2023.06.10 lub w przypadku zmian w recepturze albo w technologii wytwarzania wyrobu.

The certificate may be corrected or cancelled after appropriate motivation. The certificate loses its validity after 2023.06.10 or in the case of changes in composition or in technology of production.

Data wydania atestu higienicznego: 10 czerwca 2020

The date of issue of the certificate: 10th June 2020

Kierownik
Zakładu Bezpieczeństwa Zdrowotnego
Środowiska

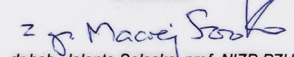
dr hab. Jolanta Solecka, prof. NIZP-PZH

Kontakt w sprawie niniejszego atestu higienicznego / To contact regarding this hygienic certificate
Zakład Bezpieczeństwa Zdrowotnego Środowiska NIZP-PZH / Department of Environmental Health and Safety NIPH-NIH
00-791 Warszawa, ul. Chocimska 24 / 00-791 Warsaw, Chocimska 24, Poland
e-mail: sek-zhk@pzh.gov.pl tel. +48 22 54-21-354, +48 22 54-21-349

Všeobecné obchodní podmínky

Tento dokument stanoví Všeobecné obchodní podmínky mezi společností TERMA Sp. z o. o., dále jen „Výrobce“ a každým podnikatelem, který je zapsán v obchodním rejstříku v souladu s právními předpisy platnými v místě výkonu jeho podnikání, dále jen „Obchodní Partner“. Obchodní Partner učiněním závazné objednávky a uzavřením smlouvy potvrzuje, že akceptuje tyto Všeobecné obchodní podmínky.

1. Pravidla správného používání produktů.

- A. Radiátory od tohoto Výrobce jsou určeny k montáži do otopných soustav, které se shodují se současnými polskými a evropskými normami, zejména s normou PN-B-02414 „Vytápění“ ; ochrana instalací teplovodního vytápění v uzavřených soustavách s membránou expanzní nádobou a s normou PN-93/C-04607 „Voda v instalacích teplovodního vytápění. Požadavky a výzkum kvality vody“, s pozdějšími změnami.
- B. Radiátory mají Prohlášení o Shodě v souladu s nařízením Evropského parlamentu a Rady (EU) č. 305/2011 ze dne 9. března 2011, kterým se stanoví harmonizované podmínky pro uvádění stavebních výrobků na trh a kterým se ruší směrnice Rady 89/106/EHS.
- C. Topné tyče od tohoto Výrobce jsou určeny k montáži do radiátorů plněných olejem s viskozitou menší než nebo rovnou 4-5 mm² /s při teplotě 40 ° C, radiátorů plněných vodou s nemrznoucí směsí určenou k přímému kontaktu s topnými prvky, v souladu s návodem k použití přiloženým k výrobku, nebo pro radiátory k ústřednímu topení. Je nepřipustné, aby topné médium v radiátoru zamrzlo.
- D. Topné tyče mají prohlášení o shodě a s ním spojené označení CE, jež potvrzují shodu s příslušnými normami a směrnicemi Evropské unie, jako jsou:
- směrnice pro nízké napětí (LVD) 2006/95/EC.
 - směrnice EMC 2004/108 / EC týkající se elektromagnetické kompatibility.
 - směrnice Evropského Parlamentu a Rady EMC 2009/125/WE týkající se ECO designu.
- E. Radiátory, topné tyče, vzpěry, sanitární držáky a madla musí být instalovány v souladu s předpoklady instalace a technickou dokumentací Výrobce, která je součástí montážního a provozního návodu dodávaného s tímto produktem.
- F. Teplota a tlak topného média, které jsou přípustné pro určitý model radiátoru nebo topné tyče, nesmí být vyšší, než je to uvedeno v technické specifikaci výrobku umístěné v technickém katalogu vedle výrobku a na produktových kartách.
- G. Čištění radiátoru, držáků, vzpěr a sanitárních madel by mělo být provedeno měkkou utěrkou za sucha, nebo – navlhčenou – v čisté vodě. Je zakázáno používat jiné chemické prostředky (zvláště prostředky s leptavými účinky) a materiály s abrazivními vlastnostmi.
- H. Povrch radiátorů, madel, držáků a vzpěr nesmí být pokryt jakýmkoliv nátěrem nebo lakem, než barvou a lakem Výrobce.

I. Věšení předmětů napuštěných aktivními látkami na výrobcích s chromovaným povlakem je zakázáno, protože to může způsobit změnu barvy nebo jiné poškození povlaku. K údržbě chromovaných radiátorů doporučujeme používat mastné látky (např. přípravek k údržbě chromovaných povrchů), který zajistí optimální a žádoucí ochranu před vnějšími faktory. Nelze čistit povrch chromovaného radiátoru prostředky, které obsahují chlor nebo používat k tomu materiály s abrazivními vlastnostmi.

J. Aby nedošlo k poškození tkaniny, dejte pozor na pro ně povolenou teplotu sušení. Zajištění správné teploty rovněž zabrání poškození povrchové úpravy Designového a el. radiátoru. Nezapomínejte na tkaniny, které mají barvicí vlastnosti (nové ručníky, směsi s chemickými vlákny), ale také tkaniny napuštěné chemickými látkami. Může to způsobit zbarvení povrchové úpravy radiátoru. Záruka Výrobce se nevztahuje na vady tohoto typu.

K. Montážní zóny radiátorů a sanitárních madel, držáků a vzpěr. Zóna „X“ znamená zdroj vody (umyvadlo, sprchový kout, vana, záchod, bidet atd.). V případě instalace radiátorů v zóně „A“ viz obrázek níže, je pro dodržení podmínek záruky naprosto nezbytné objednat dodatečnou službu pokrytí výrobku podkladovým epoxidovým nátěrem podle aktuální nabídky Výrobce. Zóna „B“ je úplně bezpečná zóna pro instalaci radiátorů se standardní povrchovou úpravou.

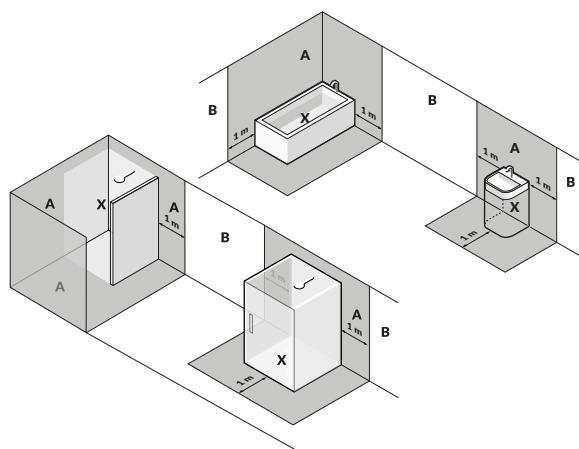

L. Abyste zabránili korozi závitů radiátorů doporučujeme při instalaci využít odborné montážní topeňářské firmy.

2. Objednávka.

A. Jakmile začne spolupráce a vždy po každé změně nebo úpravě údajů, je Obchodní Partner povinen předložit Výrobci ke dni objednávky platné registrační doklady společnosti, které uvádějí formu podnikání a potvrzují daňový status. Zákazníci z území Evropské unie jsou též povinni předložit číslo, jež bylo jim přiděleno za účelem usnadnění obchodu v Evropském společenství. Osoby samostatně výdělečně činné musí kromě toho uvést svou adresu bydliště a rodné číslo.

B. Výrobce na základě individuální smlouvy s Obchodním Partnerem stanoví hodnotu maximálního kreditu po a před splatností a platební lhůtu.

C. Výrobce přijímá objednávky:

- elektronickou cestou (e-mailem),
- výměnou dat mezi různými kompatibilními systémy s operačním systémem Výrobce.

D. Objednávka výrobku musí obsahovat produktový kód a konfigurační kód a počet objednaných kusů určitého modelu v souladu s pokyny uvedenými v aktuálním ceníku Výrobce nebo individuálním ceníku Obchodního Partnera, jenž tvoří přílohu smlouvy.

E. Objednávka nestandardního/ojedinělého zboží vyráběného dle individuálních požadavků musí být doplněna výkresem, nákresem a jasným slovním popisem, jenž umožní správné pochopení konstrukčních předpokladů nabídky.

F. V případě nekompletních objednávek (chybějící výše uvedené údaje) nebo když je potřeba upřesnit objednávku, Výrobce bude přímo kontaktovat Obchodního Partnera, aby domluvil podrobnosti objednávky. Při objednávání zboží je Obchodní Partner povinen uvést kontaktní údaje osoby určené k realizaci zakázky. Nebudou-li poskytnuty výše uvedené údaje, může to mít za následek prodloužení termínu realizace objednávky. Realizace objednávky tak může být v rozporu s očekáváním Obchodního Partnera nebo objednávka nebude realizována. V takovém případě Výrobce nenese odpovědnost za realizaci, která není v souladu s očekáváním Obchodního partnera.

G. Objednávka je přijata k realizaci v okamžiku, když Obchodní Partner obdrží od Výrobce zpětnou vazbu ze skladu, či výroby ve formě Potvrzení objednávky, které bude informovat o předpokládaném termínu dodání. Termín se z výrobních důvodů může měnit, při nedokonalé 100%-ní jakosti se může produkt vyrábět i znovu a dodání se opozdit.

H. Automaticky se generuje číslo objednávky ZS/..., které je zasláno v Potvrzení, kdy je Obchodní Partner povinnen upozornit, pokud nebude v Potvrzení objednávky správně pro výrobu nebo zaslání definováno objednané zboží. Případné reklamace budou posuzovány jen zda bylo dodáno, zboží vyráběné podle Potvrzení objednávky od Výrobce. Číslo ZS/... umožňuje kontrolu objednávky a stavu jejího vyřizování.

I. Objednávky jsou přijímány v nepřetržitém režimu, takže neexistuje možnost zrušení objednávky po zahájení výrobního procesu. V situacích, které vyžadují změnu konfigurace objednávky, okamžitě kontaktujte Prodejní Tým, který ověří, zda je možné provést změny v objednávce.

J. Každá změna objednávky může vést k prodloužení doby realizace objednávky a dodávky o dobu nezbytnou pro provedení změn zakázky.

3. Cena.

A. Prodejní ceny jsou uvedeny v měně EUro. Ceny, jestliže smlouva, obchodní nabídka nebo podmínky pro danou zemi prodeje nestanoví jinak, jsou cenami EXW podle standardu INCOTERMS 2010.

B. Ceník produktů s cenami bez DPH je zaslán Obchodnímu Partnerovi v elektronické podobě nebo jako příloha ke smlouvě.

C. Individuální nabídka je platná 30 dní, není-li v nabídce stanoveno jinak.

D. V případě plánované změny cen je Obchodní Partner informován nejpozději 1 měsíc před touto změnou.

E. Obchodní Partner je povinen zaplatit za zboží, které obdrží ve lhůtě stanovené v prodejním dokladu. Nezaplacení ve stanovené lhůtě, může mít za následek výpočet zákonných úroků z prodlení za každý den.

F. Za datum platby se považuje datum připsání finančních prostředků na bankovní účet Výrobce. Veškeré náklady spojené s převodem hradí Kupující.

4. Dodání zboží.

A. U objednávek přesahujících logistické minimum náklad na dopravu hradí Výrobce. Logistické minimum činí:

- v Polsku – neexistuje žádné logistické minimum,
- za hranice Polska - logistické minimum a cena dopravy je dohodnuta individuálně s Obchodním Partnerem,
- v EU a Norsku - doprava zdarma při objednávce v celkové výši přesahující částku 3000 EUR
- mimo EU a Norsko – logistické minimum a náklady na dodávku jsou individuálně sjednávány s Obchodním Partnerem.

B. Termíny realizace produktů:

- Výrobce má celou řadu produktů skladem, ale taky vyrábí na zakázku. Informace o produktech skladem najdete v aktuálním ceníku Výrobce, nebo obdržíte na požádání.
- Produkty na zakázku jsou realizovány do 23 pracovních dnů, pokud není Výrobce nijak výrobně omezen, nebo v závislosti na druhu výrobku.
- Výše uvedené lhůty se nevztahují na nekatalogové, investiční, atypové objednávky a katalogové objednávky na více než 10 ks jednoho produktu. U tohoto typu objednávek jsou lhůty sjednávány individuálně.
- Každá objednávka je potvrzena z hlediska obsahu a plánovaného termínu výroby během 2 pracovních dnů od jejího obdržení. Potvrzení objednávky je zasláno e-mailem na adresu nastavenou v systému, uvedenou při zahájení spolupráce.

C. Doba dodání.

- Standardní doba dodání hotových produktů na území ČR a SR je do 3 pracovních dnů od data vyslání od Výrobce.
- K dodacím lhůtám mimo území Polska by měla být přidána doba pro přepravu produktů, která se může lišit v závislosti na vzdálenosti nebo postupech celního odbavení.
- Výrobce nenese odpovědnost vůči Obchodnímu Partnerovi za zpoždění dodávky, ke kterému došlo vinou dopravce.

D. Výrobce nepřijímá bezdůvodné vrácení zboží.

E. Obchodní Partner je povinen po obdržení objednaného zboží provést okamžitou kontrolu, aby mohl zjistit případné poškození při přepravě. Jakákoli poškození, byť jen poškození bale ní Kartónu při přepravě by měla být zaznamenána a popsána v přepravních dokladech dopravce a podepsána řidičem. Aby Výrobce uznal nárok Obchodního Partnera z titulu vad zboží, vzniklých při jeho přepravě, je Obchodní Partner povinen sep

sat s řidičem přepravní služby protokol o poškození ve lhůtě stanovené v přepravních podmínkách a odeslat jej Výrobci nejpozději do 3 pracovních dnů od data jeho sepsání. Nebude-li sepsán protokol o poškození Obchodním partnerem a odeslán Výrobci ve výše uvedených lhůtách, Výrobce bude zbaven odpovědnosti za vady zboží, jež vznikly při přepravě. Použije-li Obchodní Partner vlastní nebo jinou dopravu, odpovědnost Výrobce za poškození při přepravě zaniká okamžikem předání zboží přepravci (Obchodnímu Partnerovi).

F. Produkty dodávané Výrobce jsou určeny k použití v zemi, jež byla označena Obchodním Partnerem jako místo dodání. Další distribuce produktů Obchodním Partnerem – jednotlivě nebo v integrované podobě mimo země dodání - podléhá vývozním ustanovením dané země. Obchodní Partner je povinen získat informace o příslušných předpisech a postupech týkajících se vývozu zboží do třetích zemí.

5. Záruční podmínky.

A. Výrobce dává Obchodnímu partnerovi záruku na produkty, které nabízí a ten ji pak poskytuje koncovému zákazníkovi. Mimo případy, kdy zboží leželo u Obchodního partnera. Poté musí zboží prodat v akci a informovat zákazníka o kratší záruční době, která bude jen do max. záruky Výrobce od data výroby:

- 10 let na těsnost odlévaných hliníkových radiátorů smontovaných v závodě Výrobce
- 8 let na povrchovou úpravu ocelových radiátorů ve všech barvách podle vzorníku RAL a speciálních barvách
- 8 let na povrchovou úpravu litinových radiátorů ve všech barvách podle vzorníku RAL a vybraných speciálních barvách pro litinové radiátory
- 8 let na těsnost ocelových a litinových radiátorů smontovaných v závodě Výrobce
- 4 roky na povrchovou úpravu chromovaných radiátorů
- 3 roky na povrchovou úpravu hliníkových radiátorů
- 2 roky na vybranou povrchovou úpravu litinových radiátorů

Elektrické topné tyče do radiátorů a elektrické komponenty do elektrických radiátorů

- 2 roky

Sanitární držáky, madla a vzpěry:

- 3 roky na povrchovou úpravu produktů ve všech barvách podle vzorníku RAL a speciálních barvách, a také na chrom Příslušenství pro radiátory a topné tyče:
- 2 roky

B. Záruční doba trvá přesně od okamžiku, kdy bylo zákazníkovi předáno zakoupené zboží, za předpokladu, že:

V případě topných tyčí:

- záruční doba je 2 roky od data nákupu, ale ne déle než 3 roky od data výroby.

V případě ocelových radiátorů:

- záruční doba na povrchovou úpravu a těsnost je 8 let, ale ne déle než 9 let od data výroby

- záruční doba na chromovanou povrchovou úpravu je 4 roky, ale ne déle než 5 let od data výroby

V případě litinových radiátorů:

- záruční doba na povrchovou úpravu je 2 roky, ale ne déle než 3 roky od data výroby Na těsnost souprav smontovaných výrobcem: Záruční doba je 8 let, ale ne déle než 9 let od data výroby

V případě sanitárních madel, držáků a vzpěr:

- záruční doba je 3 roky, ale ne déle než 4 roky od data výroby

V případě chromovaného Příslušenství pro radiátory a topné tyče:

- záruční doba je 2 roky, ale ne déle než 3 roky od data výroby

C. V momentě převzetí je Koncový klient povinen zkontrolovat jakost, kompletnost a shodu z jeho objednávkou. V případě zjištění jakýchkoliv vad je Klient povinen do bezodkladného nahlášení vady Obchodnímu Partnerovi, tzn. svému Prodejci před přistoupením k montáži. V případě nenahlášení vad Klientem do 7 kalendářních dnů od převzetí výrobku, přijímá se, že Prodejce předal výrobek bez vad a Klient tak výrobek přebral bez vad.

Klient je povinen po obdržení objednaného zboží provést okamžitou kontrolu, aby mohl zjistit případné poškození při přepravě. Jakákoli poškození, byť jen poškození balení Kartónu při přepravě by měla být zaznamenána a popsána v přepravních dokladech dopravce a podepsána řidičem. Aby Výrobce uznal nárok Obchodního Partnera z titulu vad zboží, vzniklých při jeho přepravě, je Klient povinen sepsat s řidičem přepravní služby protokol o poškození ve lhůtě stanovené v přepravních podmínkách a odeslat jej Prodejci nejpozději do 3 pracovních dnů od data jeho sepsání. Nebude-li sepsán protokol o poškození a přes Obchodního partnera odeslán Výrobci ve výše uvedených lhůtách, Výrobce bude zbaven odpovědnosti za vady zboží, jež vznikly při přepravě.

D. Reklamacce nahlášená Spotřebitelem se z titulu poskytnuté záruky uplatňuje prostřednictvím Obchodního Partnera vyplněním reklamačního formuláře a dodáním výrobku nebo fotodokumentace (pokud není možná demontáž), stříbrného štítku na zadní části radiátoru a dokladu o koupi. Nebudeli kterýkoli z výše uvedených dokladů předložen, bude Výrobce oprávněn nahlášenou reklamaci nebo stížnost odmítnout.

E. Výrobce projednává reklamaci z titulu poskytnuté záruky v lhůtě 14 kalendářních dnů ode dne jejího přijetí, nebo v době delší, stanovené individuálně, jestliže reklamacce vyžaduje odborné posouzení výrobku. Reklamacce je projednávána na základě dodaného výrobku nebo fotodokumentace. V případě Uznání reklamacce se Výrobce zavazuje opravit nebo dodat nový výrobek. Termín dodání je dohodnut s Klientem individuálně. Garanční oprava nezahrnuje činnosti popsané v Návodu k montáži a obsluze. Ty musí provést klient sám.

F. Náklady na výměnu výrobku vyplývající z reklamacce, jako jsou náklady na demontáž, dodávku výrobku Spotřebiteli, práce a opětovná montáž a uvedení do provozu, jsou účtovány Obchodnímu Partnerovi (tj. podnikateli, který produkt přímo prodá-

vá Spotřebiteli). Případný podíl Výrobce na nákladech spojených s výměnou nebo vrácením nákladů Obchodnímu Partnerovi je stanoven dle individuální dohody mezi Výrobce a Obchodním Partnerem. Náklady na výměnu výrobku za nový včetně jeho dodání Obchodnímu Partnerovi jsou účtovány Výrobci.

G. Reklamací lze podat prostřednictvím:

- internetového formuláře uvedeného na stránkách Výrobce www.termahat.com,

H. Záruka se vztahuje na všechny vady výrobku způsobené zaviněním Výrobce, zjištěné po dodání výrobku nebo v průběhu jeho použití. Záruka se nevztahuje na:

- poškození při přepravě způsobené dopravcem nebo vzniklé během vykládky zboží (vztahuje se pouze na vztah mezi Obchodním Partnerem a Výrobce). Podmínky pro přijetí stížnosti týkající se poškození při přepravě jsou uvedeny v bodě 4E,
- poškození během skladování (otopné těleso přijaté u skladnění je považováno za výrobek, který nemá vady.
- skladování produktů v otevřených prostorách nebo místnostech s vysokou vlhkostí,
- zásobování radiátorů médii, které se odchyluje od standardu přijatého pro daný typ výrobku (např. pára), použití topného média obsahujícího agresivní sloučeniny, které poškozují materiál, ze kterého je vyrobeno topné těleso, tj. ocel, litina nebo hliník,
- zásobování radiátorů topným médiem s pracovním tlakem, který přesahuje normativní požadavky uvedené v návodu k použití nebo technické dokumentaci výrobku nebo způsobení zvýšení tlaku v radiátoru během používání namontované topné tyče při uzavřených obou ventilech, nebo když se nechá málo volného prostoru pro roztažnost média v elektrickém radiátoru,
- mechanického či jiného poškození zaviněného Klientem po převzetí od Prodejce
- používání výrobků v rozporu s Návodem,
- poškození elektrických topných tyčí při používání pro jiné než Výrobce předepisované výkony atd.
- použití v místnostech s přítomností agresivních látek v atmosféře, jako jsou sloučeniny síry, amoniaku a chloru apod. s koncentracemi převyšujícími normální podmínky,
- montáž ocelových radiátorů v otevřených otopných systémech s přímým připojením na přívod vody a v systémech, ve kterých dochází častěji k vypouštění topného média, než to určují nezbytné provozní požadavky,
- použití elektrických radiátorů s vystavením topného prvku vodním stříkancům (bez ohledu na stupeň ochrany výrobku),
- nesprávnou (v rozporu s návodem) montáž, demontáž nebo nesprávné použití
- použití topného prvku způsobem, který je v rozporu s jeho zamýšleným použitím,
- zásah do konstrukce zařízení

I. Záruka se rovněž nevztahuje na poškození způsobená tzv. vyšší mocí, chápaná jako mimořádná, nepředvídatelná, nezaviněná událost (např. atmosférické události, poruchy elektrických zařízení, válka, přírodní katastrofy)

J. Doba trvání postupu při vyřizování reklamací, není důvodem k odmítnutí platby za dodané zboží.

K. Provádění změn a manipulace s výrobkem (pokud jde o strukturu, povrchovou úpravu atd.) Obchodním partnerem nebo Koncovým klientem má za následek ztrátu záruky.

L. Návod k výrobku je nedílnou součástí záruky. Před zahájením montáže a provozu výrobku je nutné si přečíst jeho obsah.

6. Postup při vyřizování reklamací topných tyčí pro zahraniční Obchodní Partnery z EU, kteří nedrží nastavené zásoby skladem:

A. Obchodní Partner označí topnou tyč, kterou obdržel od Spotřebitele reklamačním číslem.

B. Obchodní Partner provede předběžné posouzení např. podle vzhledu na základě materiálů obdrženejších od Výrobce. V případě zjevných poškození, která vznikla v důsledku nesprávného používání výrobku má Obchodní Partner právo samostatně odmítnout reklamací.

C. Veškeré reklamace by měly být doručeny Výrobci ve formě reklamačního formuláře prostřednictvím webového formuláře, spolu s min. 2 fotografiemi (např. přední a boční strany celé topné tyče, vady výrobku a foto namontovaného celého výrobku včetně instalace v okolí).

D. Výrobce zaeviduje reklamací do svého systému a po ověření fotografií, Neexistují-li jasné důvody pro zamítnutí reklamace, zahájí předběžné vypořádání reklamace:

- vystaví opravný doklad (dobropis) nebo
- zašle novou topnou tyč na výměnu na základě dokladu o vydání zboží ze skladu;
- v případě Obchodního Partnera, který má větší množství výrobků skladem vyřizování reklamace může být zahájeno ihned po ověření vráceného výrobku Výrobci

E. Prodejní doklad (faktura) a doklad o vydání zboží ze skladu budou označeny reklamačním číslem Obchodního Partnera.

F. Všechny topné tyče, které byly předmětem reklamace (s výjimkou těch, které byly předem zamítnuty) podléhají povinnému vrácení Výrobci. Osoba zodpovědná za obchod se dohodne s Obchodním Partnerem, jaká bude doba shromažďování topných tyčí, po uplynutí které Výrobce vyzvedne zboží. Vyzvednutí topných tyčí, které byly předmětem reklamace probíhá nejméně jednou za tři měsíce.

G. V případě, kdy Obchodní Partner nevrací všechny topné tyče z daného období, automaticky hradí cenu zboží (vystavení faktury).

H. Vracené topné tyče podléhají podrobnému odbornému posudku, v důsledku jeho provedení vznikne seznam topných tyčí, u kterých byla uznána reklamace (vada produktu) a rovněž těch zamítnutých (použití v rozporu s návodem, jiné vady, které nebyly způsobeny vinou Výrobce).

- I. Na základě shrnutí odborných posudků, jež je správné vyřizování reklamace probíhá konečné vypořádání s Obchodním Partnerem. V případě topných tyčí, u kterých byla uznána reklamace se předběžné vypořádání reklamace nemění.
- J. Obchodní Partner obdrží shrnutí odborných posudků a v případě zamítnutých reklamací měl by předat Spotřebiteli informace o důvodech rozhodnutí o zamítnutí reklamace, spolu s pokyny k používání produktu.
- K. Každý koncový zákazník, a zejména ten, který nahlásil reklamaci, měl by obdržet od Obchodního Partnera brožuru „Topné tyče - čemu je třeba věnovat pozornost před montáží“.
- L. Výše uvedený postup nevylučuje schéma činností, které se uplatňuje pro většinu Obchodních Partnerů z území EU, tj. shromažďování v dohodnutém období topných tyčí, které byly předmětem reklamace, vrácení většího množství zboží na účet Výrobce a obdržení vypořádání teprve po zpracování odborného posudku výrobku.

7. Závěrečná ustanovení.

- A. Vlastnictví prodaného zboží je vyhrazeno Výrobci až do zaplacení celkové ceny Obchodním Partnerem, což znamená, že Obchodní Partner se stává vlastníkem obdrženého zboží okamžikem úhrady všech částek vůči Výrobci.
- B. Obchodní Partner je povinen zachovávat mlčenlivost o údajích, týkajících se veškerých technických, technologických, obchodních a organizačních podrobností (včetně cen, slev, jiných obchodních podmínek) získaných jakýmkoli způsobem, a především tyto informace by neměly být nikdy zveřejněny. Tato povinnost existuje jak během obchodní spolupráce mezi Výrobcem a Obchodním Partnerem, tak i po jejím ukončení. Údaje mohou být zveřejněny třetím stranám pouze s písemným souhlasem Výrobce.
- C. Veškeré spory, neshody, které mohou vzniknout mezi Výrobcem a Obchodním Partnerem ve vztahu k těmto podmínkám, objednávkám, reklamacím a uzavřeným dohodám, budou řešeny nejprve smírně. Nebude-li smírného řešení dosaženo, budou spory řešeny v soudním řízení příslušným soudem pro sídlo Výrobce. Rozhodným právem pro řešení sporů je právo Polské republiky. V případě rozdílu v překladech těchto podmínek spolupráce, rozhodující význam má verze v polštině.
- D. Tyto podmínky platí od 1. července 2020.
- E. Ostatní podmínky, změny a dodatky, které nejsou obsaženy v tomto dokladu, ke své platnosti vyžadují v každém případě výslovné písemné potvrzení ze strany Výrobce.

Tabulka přepočtu pro jiné než nejčastější parametry instalace

T1 [°C]	T2 [°C]	Ti [°C]					
		5	8	12	16	20	24
95	85	0.50	0.52	0.56	0.60	0.64	0.70
	80	0.52	0.55	0.59	0.63	0.68	0.73
	75	0.54	0.57	0.61	0.66	0.72	0.78
	70	0.57	0.60	0.65	0.70	0.76	0.83
90	80	0.54	0.57	0.61	0.66	0.71	0.77
	75	0.57	0.60	0.64	0.69	0.75	0.82
	70	0.59	0.63	0.67	0.73	0.80	0.87
	65	0.62	0.66	0.71	0.78	0.85	0.94
85	75	0.59	0.62	0.67	0.72	0.79	0.86
	70	0.62	0.65	0.71	0.77	0.84	0.92
	65	0.65	0.69	0.75	0.81	0.89	0.99
	60	0.69	0.73	0.79	0.87	0.96	1.07
80	70	0.64	0.68	0.74	0.81	0.88	0.97
	65	0.68	0.72	0.78	0.86	0.94	1.05
	60	0.72	0.76	0.83	0.92	1.02	1.14
	55	0.76	0.81	0.89	0.99	1.10	1.24
75	65	0.71	0.75	0.82	0.90	1.00	1.12
	60	0.75	0.80	0.88	0.97	1.08	1.21
	55	0.80	0.85	0.94	1.04	1.17	1.33
	50	0.85	0.91	1.01	1.13	1.29	1.48
70	60	0.79	0.84	0.93	1.03	1.15	1.30
	55	0.84	0.90	0.99	1.11	1.25	1.42
	50	0.89	0.96	1.07	1.21	1.37	1.59
	45	0.96	1.04	1.17	1.33	1.53	1.80
65	60	0.83	0.89	0.98	1.10	1.23	1.40
	55	0.88	0.95	1.05	1.18	1.34	1.54
	50	0.94	1.02	1.14	1.29	1.48	1.72
60	55	0.93	1.01	1.13	1.27	1.45	1.68
	50	1.00	1.08	1.22	1.39	1.60	1.88
	45	1.08	1.17	1.33	1.53	1.79	2.14
55	50	1.07	1.16	1.31	1.50	1.75	2.07
	45	1.15	1.26	1.43	1.66	1.96	2.37
	40	1.25	1.38	1.59	1.87	2.25	2.80
50	45	1.23	1.35	1.56	1.82	2.17	2.67
	40	1.34	1.49	1.73	2.05	2.50	3.16
	35	1.48	1.65	1.95	2.37	2.98	3.96
45	40	1.45	1.62	1.90	2.28	2.83	3.66
	35	1.60	1.80	2.15	2.64	3.38	4.61

T1 – teplota vstupu topné vody

T2 – teplota výstupu(vratky)

Ti – požadovaná teplota v místnosti

Legenda



Radiátor ve verzi vodní, ÚT



Radiátor připraven pro kombinaci vodně – el., se zapojenou topnou tyčí



Radiátor ve verzi elektrické, suchý s topným kabelem nebo naplněný olejem s topnou tyčí. Výrobek je továrně testován a připraven po zapojení do zásuvky k okamžitému užívání.



Radiátor dostupný i v chromovaném povrchu.



Výběr z nabízených připojení v ceně radiátoru



Základní možnost připojení radiátoru. Ikona označuje způsob vstupu topné vody a zpátečky v daném připojení a umístění termostatické hlavice a topné tyče, pokud je možné je namontovat.



Výkon elektrického radiátoru nebo předepsaný výkon topné tyče pro radiátor vodní ÚT.



Váha



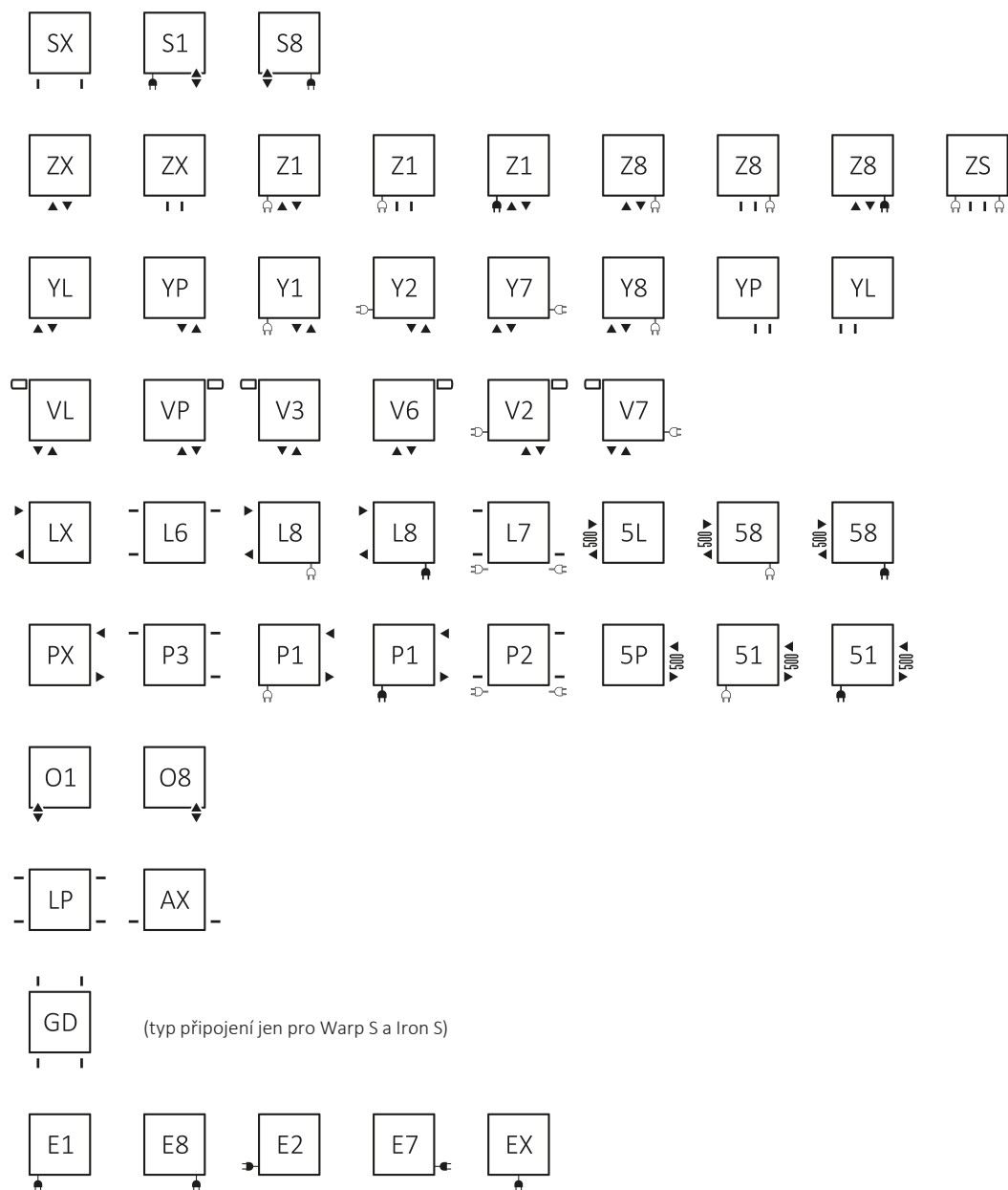

Objem

Výběr připravení otvorů pro připojení



Vysvětlivky

 čárky označují jen připravení připojovacích otvorů s 1/2" vnitřním závitem se vstupem a výstupem topné vody (u SX ventil s ponornou trubicí umožňuje využít jeden otvor pro vstup i výstup a druhý otvor pro topnou tyč).

 označují povinné připravení vstupu a výstupu topné vody topenářskou firmou

 označení místa otvoru možného připojení libovolné TERMA topné tyče

 označení místa zabudované topné tyče ONE

Konstrukce kódu konfigurace Vodního radiátoru ÚT (kód začíná „WG“)

Kódy produktů najdete v tabulkách výrobků v katalogu nebo ceníku a poskytují informace o verzi, názvu a rozměru. Pro další specifikaci produktu jako barva, typ připojení, topná tyč a druh kabelu je třeba kódy produktů doplnit o Vámi vyspecifikovaný KONFIGURAČNÍ KÓD. Konfigurační kód by měl být umístěn v řetězci znaků po kódu produktu, jak uvádí příklad níže:

KONSTRUKCE KÓDU

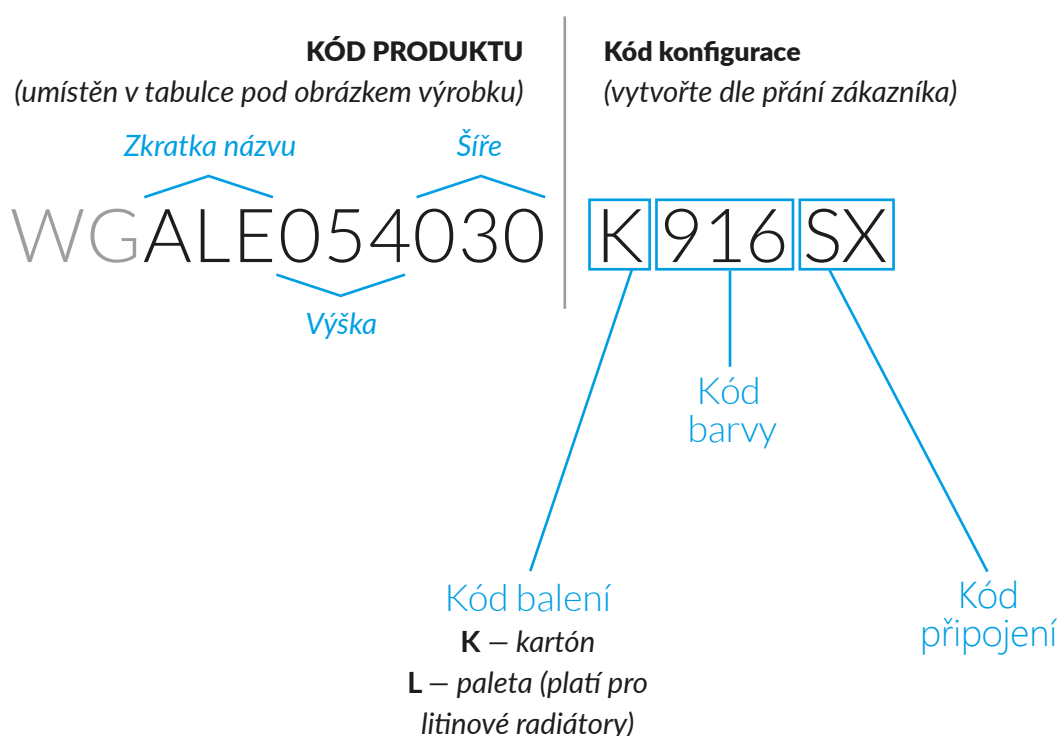

WG – Radiátor vodní, při přibojednání topné tyče vodně-elektrický zapojený do systému ústředního topení ÚT

Konstrukce kódu konfigurace Kombinovaného radiátoru vodně-elektrického se zabudovanou topnou tyčí ONE (kód začíná „WZ“)

Kódy produktů najdete v tabulkách výrobků v katalogu nebo ceníku a poskytují informace o verzi, názvu a rozměru. Pro další specifikaci produktu jako barva, typ připojení, topná tyč a druh kabelu je třeba kódy produktů doplnit o Vámi vyspecifikovaný KONFIGURAČNÍ KÓD. Konfigurační kód by měl být umístěn v řetězci znaků po kódu produktu, jak uvádí příklad níže:

KONSTRUKCE KÓDU

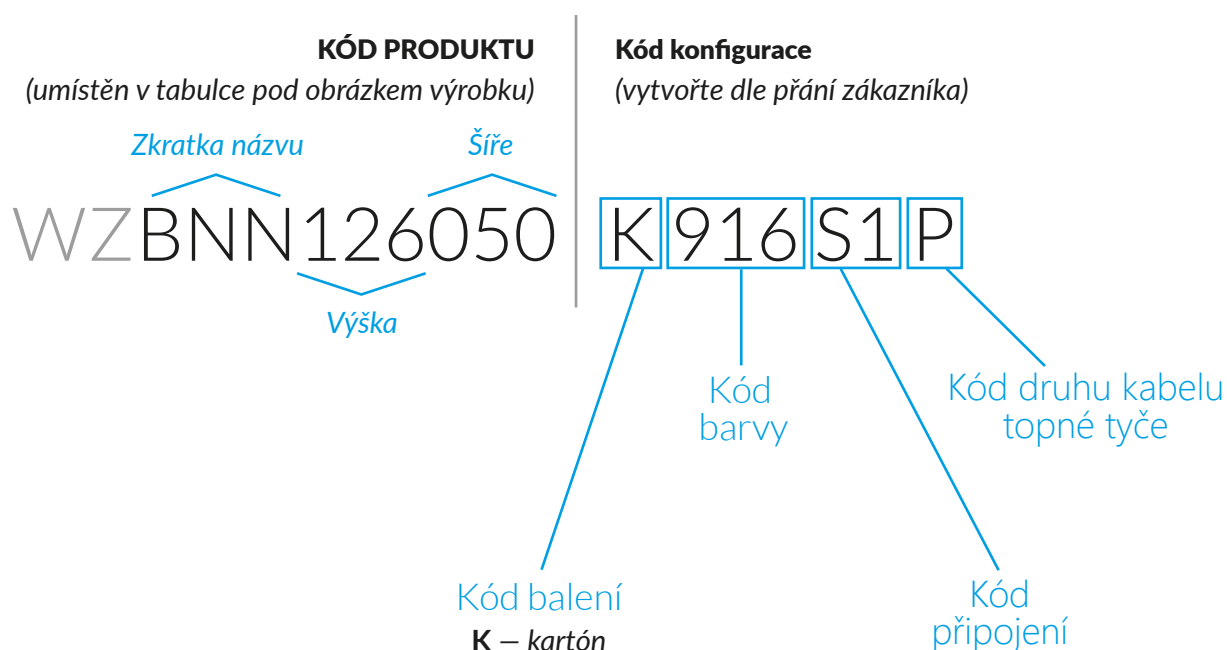

WZ – Kombinovaný radiátor vodně-elektrický se zabudovanou topnou tyčí ONE

Konstrukce kódu konfigurace Elektrického radiátoru uzavřeného, naplněného olejem a zabudovanou topnou tyčí ONE (kód začíná „WW“)

Kódy produktů najdete v tabulkách výrobků v katalogu nebo ceníku a poskytují informace o verzi, názvu a rozměru. Pro další specifikaci produktu jako barva, typ připojení, topná tyč a druh kabelu je třeba kódy produktů doplnit o Vámi vyspecifikovaný KONFIGURAČNÍ KÓD. Konfigurační kód by měl být umístěn v řetězci znaků po kódu produktu, jak uvádí příklad níže:

KONSTRUKCE KÓDU

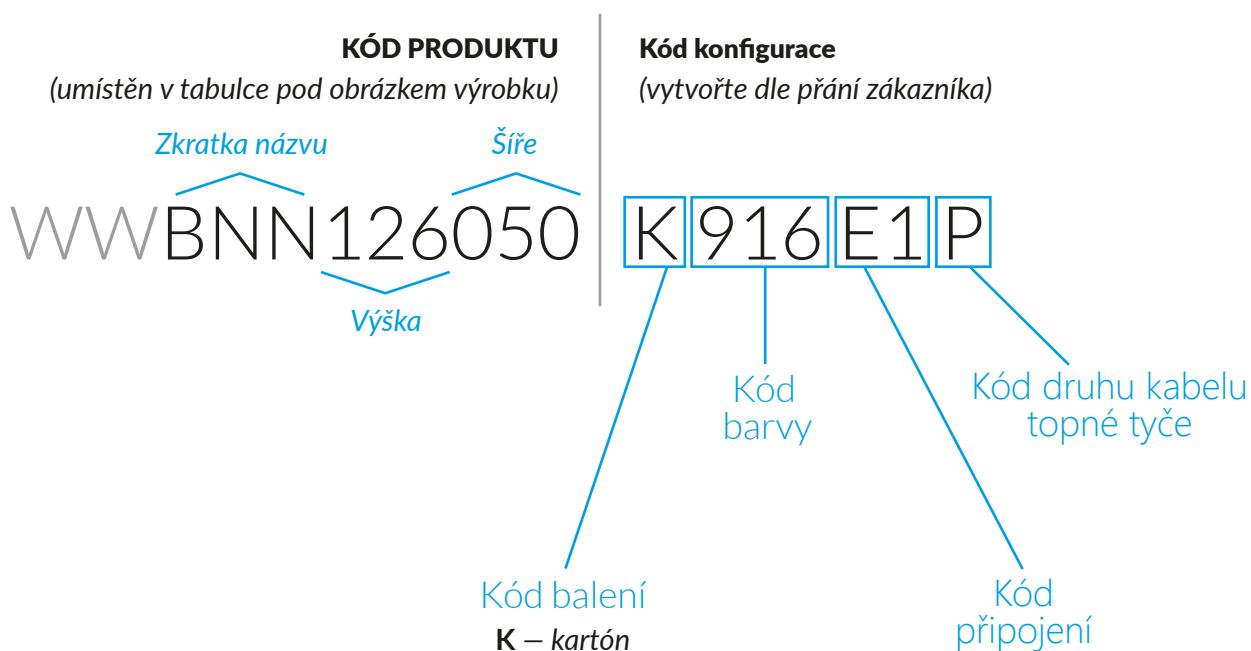

WW – Elektrický radiátor uzavřený naplněný olejem a zabudovanou topnou tyčí ONE

Konstrukce kódu konfigurace Elektrického radiátoru uzavřeného naplněného olejem a zvolenou topnou tyčí - např. KTX, MOA, REG i ONE v 8cm profilu (kód začíná „WL“)

Kódy produktů najdete v tabulkách výrobků v katalogu nebo ceníku a poskytují informace o verzi, názvu a rozměru. Pro další specifikaci produktu jako barva, typ připojení, topná tyč a druh kabelu je třeba kódy produktů doplnit o Vámi vyspecifikovaný KONFIGURAČNÍ KÓD. Konfigurační kód by měl být umístěn v řetězci znaků po kódu produktu, jak uvádí příklad níže:

KONSTRUKCE KÓDU

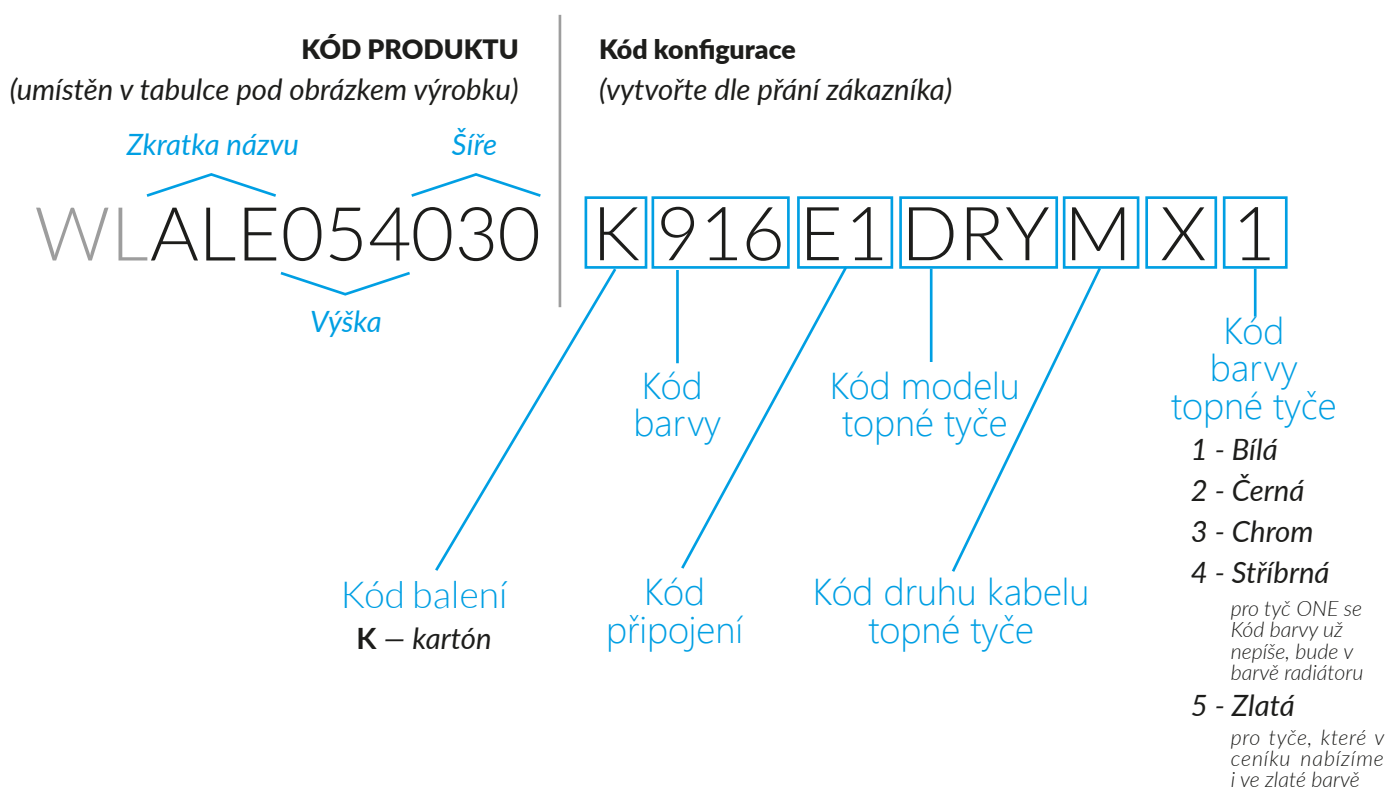

Pro topné tyče ze 2 částí pište do kódu TS1D a samostatně objednejte vybraný regulátor KTX, nebo SS1D a samostatně objednejte regulátor VEO.

WL – Elektrický radiátor uzavřený naplněný olejem s nainstalovanou zvolenou topnou tyčí (např. KTX, MOA, REG i ONE v 8cm profilu)

Konstrukce konfiguračního kódu pouze pro 2 typy Elektrických suchých radiátorů Perla E a Spiro - suché s topným kabelem v celém těle (kód začíná „WS“)

Kódy produktů najdete v tabulkách výrobků v katalogu nebo ceníku a poskytují informace o verzi, názvu a rozměru. Pro další specifikaci produktu jako barva, typ připojení, topná tyč a druh kabelu je třeba kódy produktů doplnit o Vámi vyspecifikovaný KONFIGURAČNÍ KÓD. Konfigurační kód by měl být umístěn v řetězci znaků po kódu produktu, jak uvádí příklad níže:

KONSTRUKCE KÓDU

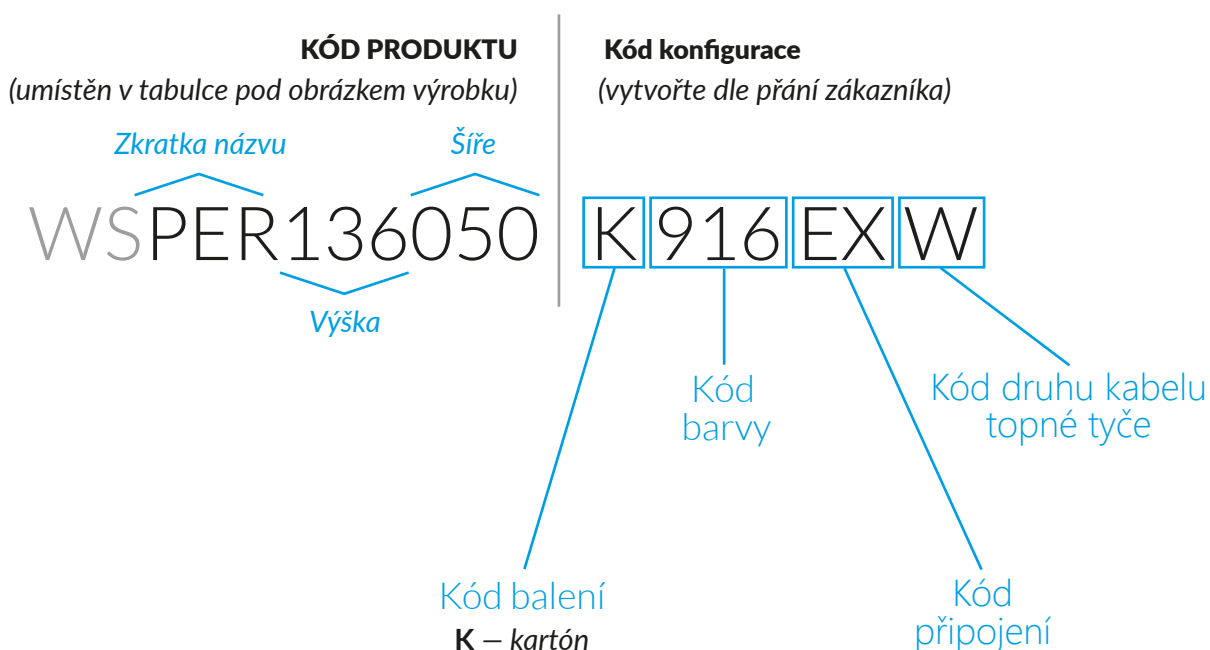

WS – Elektrický radiátor suchý s topným kabelem

Konstrukce konfiguračního kódu konfigurovatelného Příslušenství (kód začíná „WR“)

Kódy produktů najdete v tabulkách výrobků v katalogu nebo ceníku a poskytují informace o verzi, názvu a rozměru. Pro další specifikaci produktu jako barva, typ připojení, topná tyč a druh kabelu je třeba kódy produktů doplnit o Vámi vyspecifikovaný KONFIGURAČNÍ KÓD. Konfigurační kód by měl být umístěn v řetězci znaků po kódu produktu, jak uvádí příklad níže:

KONSTRUKCE KÓDU



WR – Příslušenství konfigurovatelné

Konstrukce konfiguračního kódu Opláštění CASE SLIM s barevným sklem, zrcadlem nebo sklem s potiskem (kód začíná „WR“)

Kódy produktů najdete v tabulkách výrobků v katalogu nebo ceníku a poskytují informace o verzi, názvu a rozměru. Pro další specifikaci produktu jako barva, typ připojení, topná tyč a druh kabelu je třeba kódy produktů doplnit o Vámi vyspecifikovaný KONFIGURAČNÍ KÓD. Konfigurační kód by měl být umístěn v řetězci znaků po kódu produktu, jak uvádí příklad níže:

KONSTRUKCE KÓDU

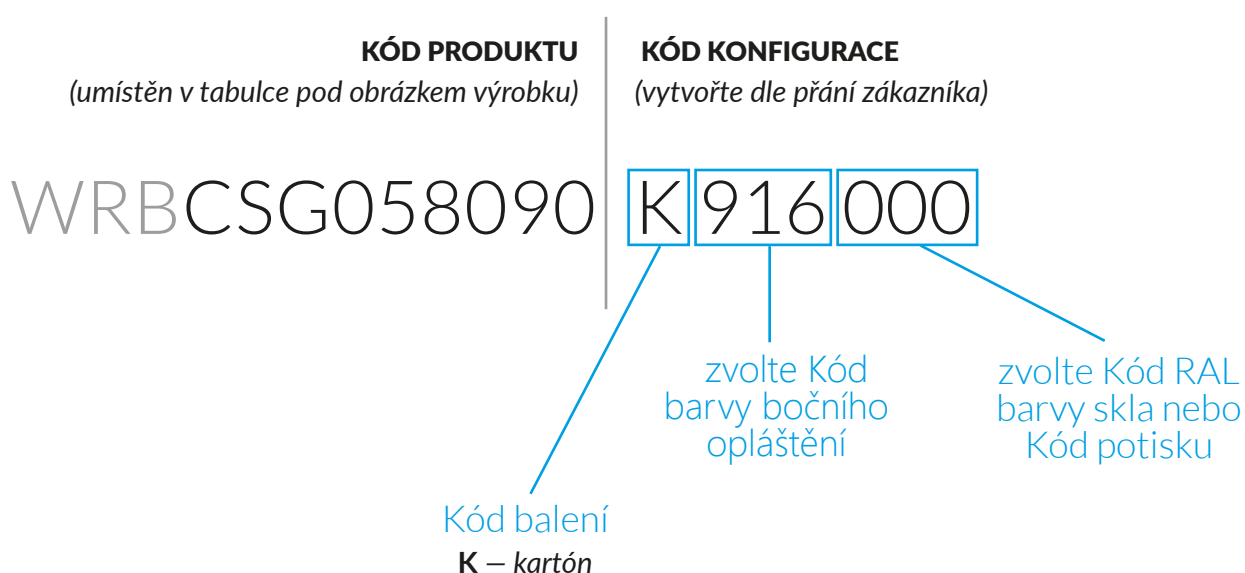

WR – Příslušenství konfigurovatelné

Konstrukce konfiguračního kódu elektrického přímotopu SMART Wi-Fi VOLTAN (kód začíná „WK”)

Kódy produktů najdete v tabulkách výrobků v katalogu nebo ceníku a poskytují informace o verzi, názvu a rozměru. Pro další specifikaci produktu jako barva, typ připojení, topná tyč a druh kabelu je třeba kódy produktů doplnit o Vámi vyspecifikovaný KONFIGURAČNÍ KÓD. Konfigurační kód by měl být umístěn v řetězci znaků po kódu produktu, jak uvádí příklad níže:

KONSTRUKCE KÓDU

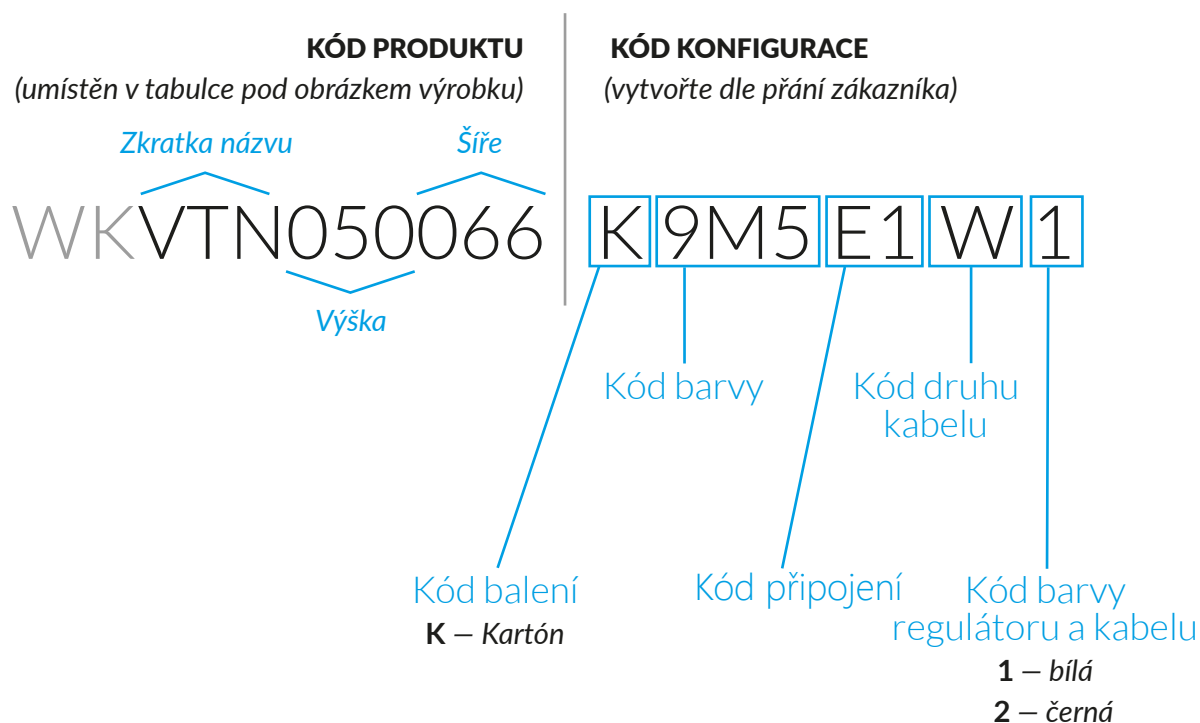

WK – elektrický přímotop Voltan

Konstrukce konfiguračního kódu příslušenství SMART Wi-Fi VAZ, VOS, VTS (kód začíná „WI“)

Kódy produktů najdete v tabulkách výrobků v katalogu nebo ceníku a poskytují informace o verzi, názvu a rozměru. Pro další specifikaci produktu jako barva, typ připojení, topná tyč a druh kabelu je třeba kódy produktů doplnit o Vámi vyspecifikovaný KONFIGURAČNÍ KÓD. Konfigurační kód by měl být umístěn v řetězci znaků po kódu produktu, jak uvádí příklad níže:

KONSTRUKCE KÓDU

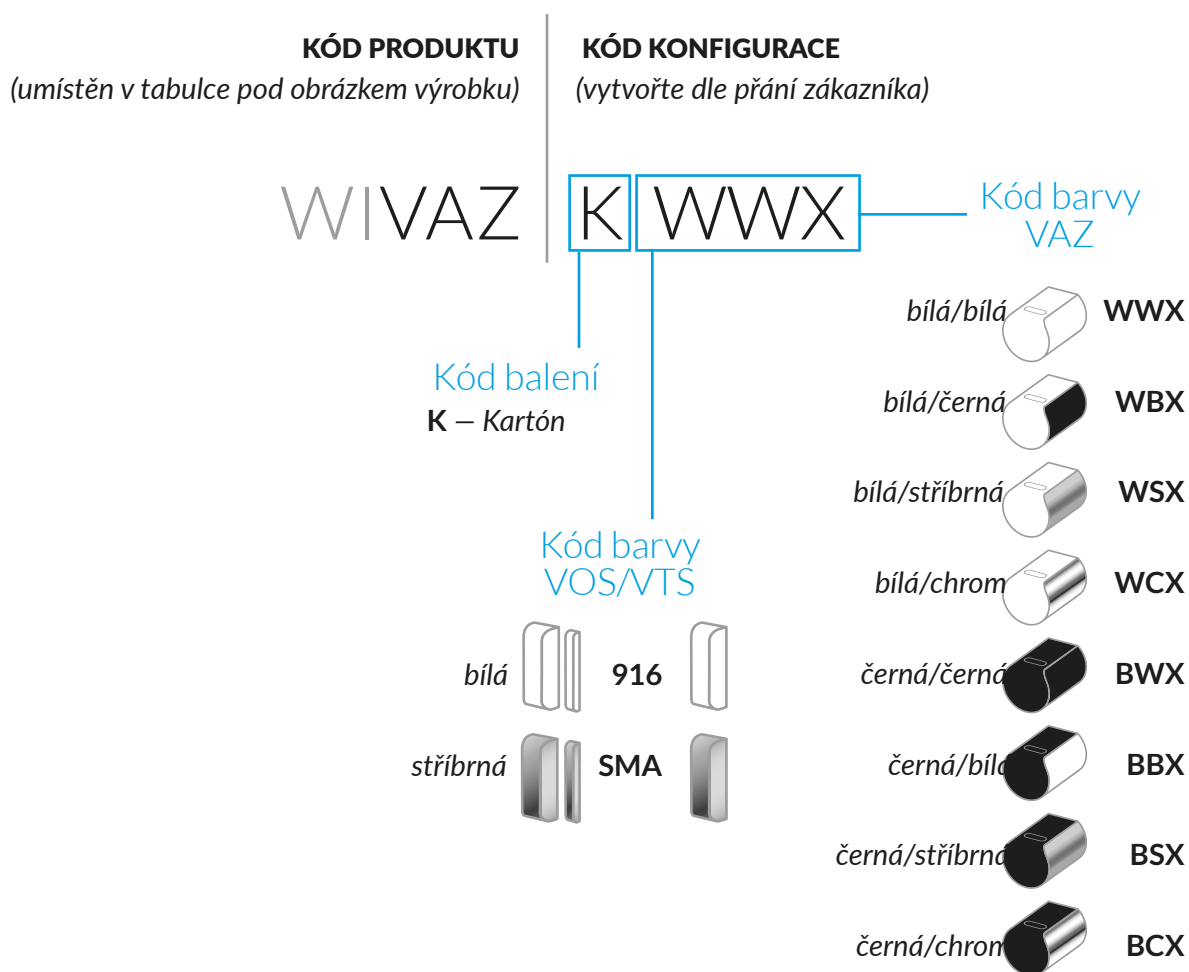

Otázky pro specifikaci radiátoru a tvoření Objednacího kódu

Kódy výrobků najdete v tabulkách výrobků v katalogu nebo ceníku a poskytují informace o verzi, názvu a rozměru.

Pro další specifikaci produktu jako barva, typ připojení, topná tyč a druh kabelu je třeba kódy produktů doplnit o Vámi vyspecifikovaný KONFIGURAČNÍ KÓD. Konfigurační kód by měl být umístěn v řetězci znaků po kódu produktu:

Každopádně pro vytvoření obou kódů je potřeba si s klientem zodpovědět těchto 9 otázek:

1. Potřebuje zákazník radiátor vodní, vodně-elektrický nebo čistě elektrický?
2. Jaký model (název radiátoru) si zákazník vybral?
3. Jaký rozměr z nabídky TERMA daného modelu si zákazník vybral?
4. Jakou barvu ze vzorníku TERMA RAL a TERMA speciální barvy si klient vybral?
5. Jaký typ připojení (na střed, do krajů atd.) si klient po konzultaci s prodejcem nebo svým topenářem vybral (viz možné typy připojení označeny zkratkou a symbolem u všech radiátorů)?
6. Pokud si přál zákazník vodně-elektrický nebo elektrický radiátor, tak jaký typ topné tyče si dle vzhledu, barvy, funkcí, ovládání vybral?
7. Jaký druh kabelu si zákazník vybral od topné tyče (přímý do zdi bez zástrčky, spirální nebo přímý se zástrčkou, přímý do zdi s krytkou kabelu)?
8. Pokud bude radiátor v nebo do 1m od vodního zdroje (umyvadlo, sprcha, záchod) je potřeba pro zachování záruky zvolit epoxidový podklad proti korozi + 39EUR bez DPH, označený jako „E“ za kódem.
9. Jakýkoliv nadstandard nebo atyp požadavek na rozměr, vzhled, uspořádání, barvu, připojení, délku kabelu (pište slovně do závorek za konec kódů a s objednávkou pošlete vždy i obdrženou cenovou nabídku Regionálního manažera na atyp řešení).

Kontakt

Terma Sp. z o.o.

Czaple 100
80-298 Gdańsk
NIP: 583-10-18-844
www.termaheat.com
M: +48 607 451 076

Regionální Manager

Jiří Lakosil
M: +420 774 924 084
Jiri.Lakosil@termagroup.pl

Objednávky zasílejte na:

orders-heating@termagroup.pl

Kontrola a dotazy na stav objednávek:

Agnieszka.Blizniewska@termagroup.pl

Řecko, Slovensko, Česká Republika, Kypr

+420 774 924 084

Německo (Region Jih)

+ 49 171 528 1085

Německo (Region Sever)

+ 49 171 528 1082

Německo (Region Západ)

+ 49 171 528 1090

Rakousko, Německo, Švýcarsko

+ 48 607 451 306
+ 48 887 022 427

Nizozemí, Lucembursko

+ 48 607 451 947

Velká Británie, Irsko, Austrálie, Nový Zéland

+ 44 (0)1942 272 172 (UK Office)
+ 44 (0)7375 519 211
+ 48 607 451 960

Francie

+ 33 6 99 91 01 01
+ 48 607 451 035

Belgie, Portugalsko, Španělsko

+ 48 607 451 035

Itálie

+ 39 347 786 386 0
+ 48 607 451 035

Dánsko, Finsko, Švédsko, Island, Norsko, Turecko

+ 48 607 451 984

Litva, Lotyšsko, Estonsko

+ 48 607 779 066

Bělorusko, Moldávie, Ukrajina, Kazachstán

+ 48 607 451 202

Rusko

МО, Ленинский район, ГП Видное, д. Апаринки,
стр.1, корпус 2, 2 этаж
+7 963 644 34 36
+7 963 644 34 37
+7 963 644 34 38
+7 963 644 34 39

Bosna a Hercegovina, Chorvatsko, Severní Makedonie, Srbsko, Slovinsko, Maďarsko

+420 774 924 084

Uvedené informace byly aktuální v době zveřejnění. Základním principem firmy Terma je neustálé zlepšování kvality výrobku, a proto tyto informace nejsou závazné a mohou se měnit bez předchozího oznámení. Společnost Terma si vyhrazuje právo provést změny ve verzích prezentovaných produktů.
Obrázky použité v tomto ceníku mají pouze ilustrativní charakter a nejsou předmětem nabídky.



Terma Sp. z o.o.
Czaple 100
80-298 Gdańsk
NIP: 583-10-18-844
www.termaheat.com