



**Every week for  
whole year you  
can win a shower  
unit!**

# PRICE LIST 03/2023

For specialised trade outlets only. Suggested retail prices in EUR not including VAT.  
This price list replaces all previous price lists.



# Artweger is celebrating its jubilee!

**And you get the presents!**

**Every week for whole year you can win a shower unit!**

It's so easy: In 2023, you simply need to sell Artweger shower units to your customers. Because with every shower unit ordered, you automatically take part in the next draw! And that's the case for a whole year from 01.01.2023 until 31.12.2023!  
We wish you all the best by taking part and with a little luck, you will be amongst the winners.



**THE MORE OFTEN YOU ORDER AN ARTWEGER SHOWER UNIT,  
THE GREATER THE CHANCE OF WINNING!**

**TIP:**

## **Terms of Participation:**

Eligible are only plumbing companies and bathroom showrooms, ordering an Artweger shower unit from 01.01.2023 until 31.12.2023. Artweger employees are excluded from the competition. The draw takes place weekly, without the possibility of recourse to legal action. The winners will be notified personally and their names will be published at regular intervals (approx. 3 weeks) after consent has been granted. The prize cannot be taken as cash.

## NEW PRODUCTS

see page



## Anniversary Edition Artweger PRO:TECT

68, 98, 170

<b>ARTWEGER 360 folding doors</b> - equipment with glass RW Strip Satin available	36 - 41
<b>ARTWEGER 360 Walk In partially framed</b> - new standard widths 1000, 1200 and 1400 mm	82
<b>ARTWEGER 360 Walk In VARIO partially framed</b> - new standard widths 1300, 1400 and 1500 mm	82
<b>TWISTLINE</b> - equipment with glass SA Satin or RW Strip Satin available	104 - 119
<b>TWISTLINE folding doors</b> - equipment with glass RW Strip Satin available	120 - 123
<b>ARTWEGER 360 bathtub enclosures</b> - equipment with glass RW Strip Satin available	168 - 169
<b>BODY + SOUL</b> - steam box with front side in glass Bordeaux	187
<b>ARTWALL 3.0 - modern wall panels</b>	220 - 223
<b>ARTSTONE</b> - new size 1600 × 1000 and drain set with sealing tape	225

## NO LONGER IN PRODUCT LINE

<b>Glazing RS Strip Satin 1</b> - see successor product glass RW Strip Satin
<b>ARTWEGER 360 Walk In</b> - The assortment has been simplified.
<b>LIFELINE</b> 1/4-round showers
<b>BODY + SOUL</b> - steam box with front side in the color Bordeaux (plastic)
<b>TWINLINE 1</b> - shower bathtubs 1600 × 1000 and 1800 × 1000 rounded
<b>ARTWALL</b> - see successor product ARTWALL 3.0
<b>ARTSTONE</b> - size 900 × 750
<b>ACRYLIC</b> - bathtub BARBARA 1800 × 800

## FURTHER INFORMATION

<b>Price list including WAREHOUSE STOCK</b>	2
<b>ARTWEGER 360, TWISTLINE</b> - Redesigned stabilisers with new article numbers.	
<b>ARTWEGER 360 Walk In</b> - The selection of adjustable foot or edge protection in the floor area is no longer necessary. Both options are now included in the scope of delivery.	

# COMPLETE SHOWER AREA FROM A SINGLE SOURCE

## 1 SHOWER ENCLOSURES

## 2 MODERN WALL PANELS

## 3 SHOWER SYSTEMS

## 4 SHOWER TRAYS



## WAREHOUSE STOCK

### PROMPT DELIVERY

126	DYNAMIC	Swinging doors	partially framed
136	MOVE	Sliding doors	with frame
157	SLIDE	Sliding doors	with frame
200	TWINLINE 2	Shower bathtubs	partially framed
238	ARTSHOWER	Shower systems	
244	ACCESSORIES		

### READY FOR DISPATCH WITHIN 2 DAYS

222	ARTWALL 3.0	Wall panelling	wall panels
-----	-------------	----------------	-------------

### READY FOR DISPATCH WITHIN 3 DAYS

225	ARTSTONE	Shower trays	cast stone
228	SHOWER TRAYS		acrylic
230	BATHTUBS		acrylic



<b>1</b>	<b>WINGED DOORS</b>		
	18	ARTWEGER 360	partially framed
	44	ARTWEGER 360	frameless
	<b>SWINGING DOORS</b>		
	26	ARTWEGER 360	partially framed
	52	ARTWEGER 360	frameless
	68	PROTECT Anniversary Edition	partially framed
	104	TWISTLINE	partially framed
	124	DYNAMIC	partially framed
	162	BASELINE	with frame
	<b>SLIDING DOORS</b>		
	62	ARTWEGER 360	with frame
	138	MOVE	with frame
	142	MOVE	frameless
	146	LIFELINE	with frame
	156	SLIDE	with frame
	160	BASELINE	with frame
	<b>FOLDING DOORS</b>		
	36	ARTWEGER 360	partially framed
120	TWISTLINE	partially framed	
<b>ARTWEGER WALK IN</b>			
82	ARTWEGER 360	partially framed	
86	ARTWEGER 360	frameless	
88	ZERO	partially framed	
94	ZERO BASIC	partially framed	
98	PROTECT Anniversary Edition	partially framed	
100	DYNAMIC	partially framed	
102	MOVE	with frame	
102	MOVE	frameless	
<b>STEAM SHOWERS</b>			
180	BODY+SOUL	partially framed	
184	BODY+SOUL	frameless	
<b>2</b>	<b>MODERN WALL PANELS</b>		
	220	ARTWALL 3.0	wall panels
<b>3</b>	<b>SHOWER SYSTEMS</b>		
	236	ARTSHOWER	
<b>4</b>	<b>SHOWER TRAYS</b>		
	224	ARTSTONE	cast stone
	226	ACRYLIC	
<b>SHOWER BATHTUBS</b>			
	188	TWINLINE 1	partially framed
	196	TWINLINE 2	partially framed
	208	ARTLIFT	partially framed
	232	FREEWAY	partially framed
<b>BATHTUBS</b>			
	230	ACRYLIC	
<b>BATHTUB ENCLOSURES</b>			
	168	ARTWEGER 360	partially framed
	170	PROTECT Anniversary Edition	partially framed
	172	MOVE	with frame
	172	MOVE	frameless
	174	BASELINE	with frame
<b>MISCELLANEOUS</b>			
	244	ACCESSORIES	
	246	SPARE PARTS	

		Bathtub-enclosures																								
	CODE	ARTWEGER 360 partially framed	ARTWEGER 360 frameless	ARTWEGER 360 Sliding doors	PROTECT	ARTWEGER 360 Walk In	Artweger ZERO Walk In	TWISTLINE	DYNAMIC	MOVE	LIFELINE	LIFELINE MOBIL	SLIDE	BASELINE	ARTWEGER 360	PROTECT	BASELINE	BODY+SOUL	ARTWALL	TWINLINE 1	TWINLINE 2	ARTLIFT	ARTSTONE	SHOWER TRAYS, BATHTUBS	FREWAY	
<b>Colours</b>																										
High-gloss metal	MH	●		●	◆	◆	●	●	●	●	◆	●	●	●	●			◆	●	●	●	●				●
Chrome	VC		●			◆												◆								
Natural anodised	NX																									
White	WS	●	●	●		◆		●		●	●	●		●	●		●	◆		●	●					
Silver	LB									●	●	●		●	●		●	◆			●					
Matt black	SM				◆					●	●	●							●		●					
Matt white	WM				◆					●																
High-gloss metal / Matt aluminium	MA				●												●									
High-gloss metal / Graphite	MP				●												●									
Matt white / Graphite	WP				●												●									
Matt black / Graphite	SP				●												●									
Graphite metallic	GF									●																
Champagne	CN									●																
Mokka	MK									●																
Bronze	BZ									●																
Additional colours on request	. .	□	□	□		□	□			□	□	□		□	□	□	□	□	□	□	□	□	□	□	□	□
<b>Glazing</b>																										
Glass thickness in mm	-	6	6	8	6	8	8	6	6	6	6	6	6	3	6	6	3	6		6	8/6	8/6				8/6
Diamond (plastic)	DD													◆			●									
Glass clear (ESG)	EK	●	●	●	●	●	●	●	●	●	●	●	●	●	●	●	●	●	●	●	●	●	●	●	●	●
Satin (ESG)	SA	◆	◆	◆	◆	◆	◆	◆	◆	◆	◆	◆	◆	◆	◆	◆	◆	◆	◆	◆	◆	◆	◆	◆	◆	◆
Strip Satin (ESG)	RW	◆	◆	◆	◆	◆	◆	◆	◆	◆	◆	◆	◆	◆	◆	◆	◆	◆	◆	◆	◆	◆	◆	◆	◆	◆
<b>Glass finishing (ESG)</b>																										
ARTCLEAR GLAZING	C	●	●	●	●	●	●	●	●	●	●	●	●	●	●	●	●	●	●	●	●	●	●	●	●	●
ART-Clean coating													●													
<b>Handle, hinge</b>																										
Chrome	VC	●	●	●							●	●						●	●	●	●	●	●	●	●	●
Same as frame	. .	◆		●	◆					●	●	●				◆	◆	◆	◆	◆	◆	◆	◆	◆	◆	◆
<b>Steam box<sup>1</sup>, seat<sup>2</sup></b>																										
Anthracite/silver RAL 7021/RAL 9006 <sup>1,2</sup>	AT																	●	●	●	●	●	●	●	●	●
Bordeaux/silver RAL 3011/RAL 9006 <sup>2</sup>	BD																	●	●	●	●	●	●	●	●	●
Sand/silver RAL 1015/RAL 9006 <sup>1,2</sup>	SA																	●	●	●	●	●	●	●	●	●
Glass clear/Silver <sup>1</sup>	GH																	●	●	●	●	●	●	●	●	●
Glass Anthracite/silver <sup>1</sup>	GT																	●	●	●	●	●	●	●	●	●
Glass Bordeaux/silver <sup>1</sup>	GB																	●	●	●	●	●	●	●	●	●
<b>Roof element</b>																										
Cover plate and frame white, Overhead showerhead, chrome-plated	-																	●								
<b>Shower tray colours</b>																										
White slate	WF																							●		
Anthracite slate	AF																							●		
White Acrylic	WS																	●			●	●	●	●	●	●
White GRP	WS																			●		●	●	●	●	●
ART-Grip Skid-resistant zone	A																	●		●	●	●	◆	●	●	●
<b>System colour</b>																										
Drain, overflow chrome-plated (as standard)	-																			●	●	●	●	●	●	●
Inlet/drain/overflow chrome-plated (optional)	E																			●						
Inlet set chrome-plated (optional)	E																				●	●				
<b>Seat<sup>1</sup>, neck support<sup>2</sup>, backrest<sup>3</sup> plastic</b>																										
White <sup>1,2</sup>	WS																			●						
Silver <sup>1,2</sup>	SB																			●						
Anthracite <sup>3</sup>	AT																				●	●				
<b>Seat lift plastic</b>																										
Anthracite	AT																						●			
<b>Skirt - door skirt always white</b>																										
Plastic white	WS																						●	●	●	●
Artwall 3.0	. .																						●	●	●	●
Glass clear	GH																						●	●	●	●
Glass Anthracite	AT																						●	●	●	●
Glass Bordeaux	BD																						●	●	●	●

● Available

□ Delivery on request





◆ Not for all products and/or sizes. Available when a price is listed with the corresponding article.

### IMPORTANT



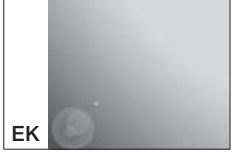



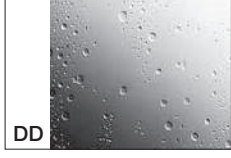





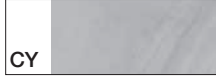

- We reserve differences in colour from ceramic, enamelled steel and plastic bath products. Functional elements made of white plastic. Custom colours and glass on request.

**SINGLE-PANE SAFETY GLASS (ESG)**



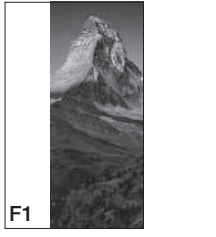
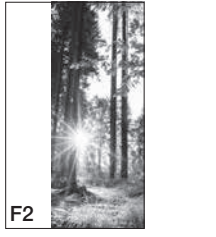



**SYNTHETIC GLAZING**

 <b>EK</b> Glass clear	 <b>SA</b> Satin	 <b>RW</b> Strip Satin State height position H when ordering. The height position always refers to the bottom of the Satin strip.	 <b>C</b> ARTCLEAR GLAZING GLASS FINISHING (ESG)	 <b>DD</b> Diamond
---	---	---	---	---

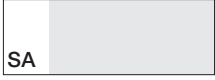
**ARTWALL 3.0 colours and decors for ARTWALL 3.0, TWINLINE 1, TWINLINE 2 and ARTLIFT**

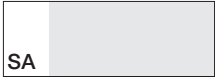
 <b>WM</b> White	 <b>BT</b> Concrete	 <b>RS</b> Rust	 <b>CY</b> Canyon	 <b>SC</b> Slate	Matt surfaces
 <b>NB</b> Stone beige	 <b>NG</b> Grey stone	 <b>NH</b> Light stone colour	 <b>NV</b> Stone Verdello	 <b>EI</b> Oak	
 <b>WG</b> Glossy white	 <b>MB</b> Beige glossy marble	 <b>F1</b> Matterhorn	 <b>F2</b> Forest	 <b>F3</b> Beach	Glossy surfaces
 <b>MG</b> Grey glossy marble	 <b>ML</b> Light glossy marble	Photo motifs only for ARTWALL 3.0 TREND wall panels 2550 x 1000 mm.			

**BODY+SOUL**

 <b>AT</b> Anthracite/silver Plastic	 <b>SA</b> Sand/silver Plastic	 <b>BD</b> Bordeaux/silver Plastic	Seat
 <b>AT</b> Anthracite/silver Plastic	 <b>SA</b> Sand/silver Plastic	 <b>GH</b> Glass clear/Silver	
 <b>GT</b> Glass anthracite/silver	 <b>GB</b> Glass Bordeaux/silver		

**TWINLINE 1, TWINLINE 2, ARTLIFT glass for skirts**

 <b>GH</b> Glass clear	 <b>AT</b> Glass Anthracite	 <b>BD</b> Glass Bordeaux
---	--	--

Colour illustrations can be found on the back cover page.

**IMPORTANT - SINGLE-PANE SAFETY GLASS (ESG)**

• By means of careful heat treatment according to EN 12150, the glass obtains considerably increased resistance to impact, shock and temperature change. Due to these properties, the glass can be used as a structural element for shower enclosures. If the glass breaks, mostly blunt-edge glass granules form that partially remain tightly interlaced with one another. Possible danger of injury is thereby reduced significantly.

Not all shower enclosures are the same. Depending on model and execution different levels of splash protection can be obtained. The basic rule is: The higher the frame and overflow moulding, the better the protection.

**When used on tiled floors a furrow or slant in the floor (toward the drain within the shower area) is necessary.**



### PRONOUNCED FRAME PIECES

The shower spray and accumulated splash water are held in the shower by the high floor frame piece (overflow moulding).

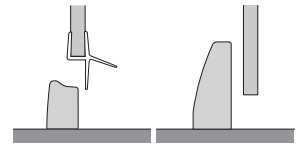

### FLAT FRAMES

A flat overflow moulding (floor frame piece) offers less protection against splashes.

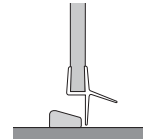

### NO FRAME

If no overflow moulding is installed, splash water can escape more easily. Where the downward incline is insufficient or when mounting on a shower tray, a splash water bar is required for adequate protection.

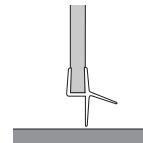

Shower screens with the VARIO sealing system are delivered with an optional surge bar. You can decide when installing – and/or at a later date – if you want to use the surge bar. NOTE: We do point out that installation of the surge bar included in the scope of delivery is necessary to achieve the water tightness required to comply with the standard (DIN 14428). If you go without the surge bar it reduces the water tightness. We do not accept liability for any damage resulting from not installing the surge bar.

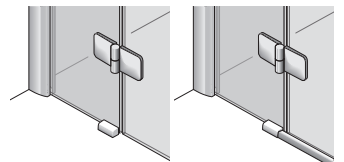

## Shower enclosure left or right

Always make decisions about right or left from in front of the shower.

EXAMPLE 1: 1/4-round shower

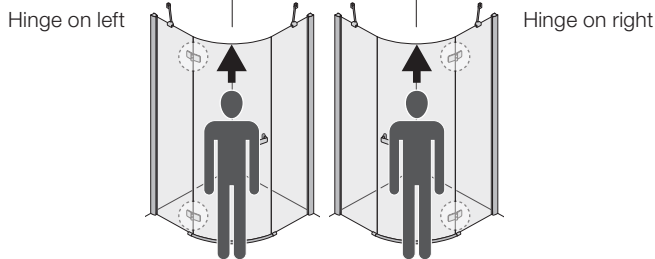

EXAMPLE 2: Shower door with side screen

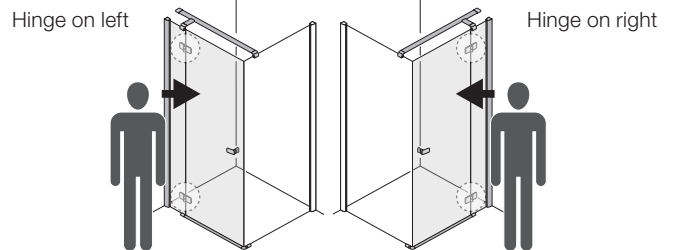

## Available radiuses and centre measurements for quarter-round and pentagonal shower trays

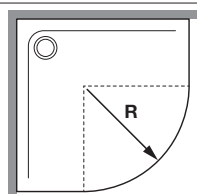

Radius **R**  
 I = 500 mm (R=500)  
 II = 550 mm (R=550)

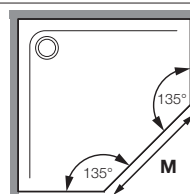

Centre measurement **M**  
 I = 707 mm (M=707)  
 II = 600 mm (M=600)  
 IV = 636 mm (M=636)

## Determining the radius or centre when the shower tray is unknown

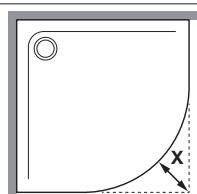

Radius **R**  
 x = 207 mm = 500 mm (R=500)  
 x = 228 mm = 550 mm (R=550)  
 x = 215 mm = 520 mm (R=520)  
 x = 199 mm = 480 mm (R=480)

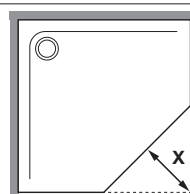

Centre measurement **M**  
 x = 354 mm = 707 mm (M=707)  
 x = 300 mm = 600 mm (M=600)  
 x = 318 mm = 636 mm (M=636)

# STABILIZERS IN DETAIL

ARTWEGER price list 03/2023. For specialised trade outlets only. DIMENSIONS IN MILLIMETRES.

The stabilizers add to the height. See following sketches.

**Installation height = minimum room height required for door mounting and stabiliser.**  
**You will find the required installation height at the respective product.**

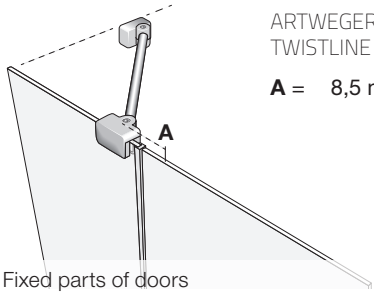
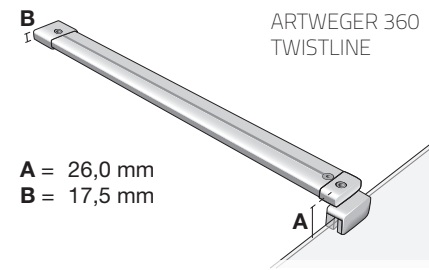
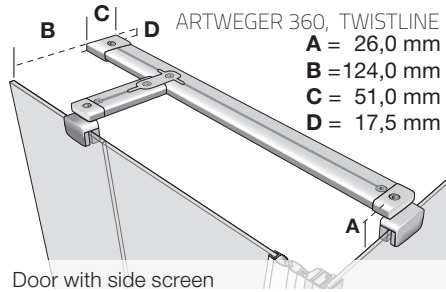
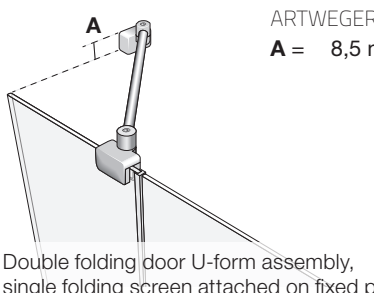
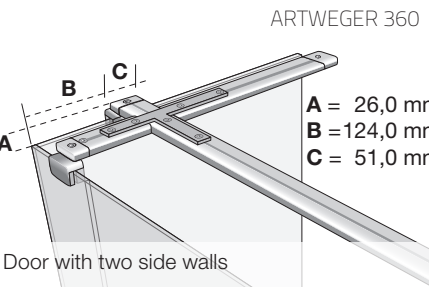
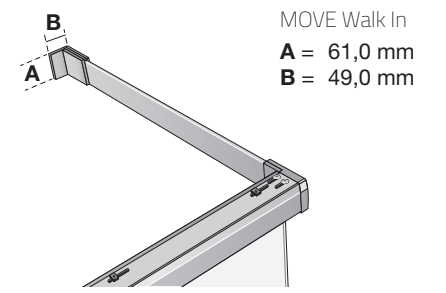
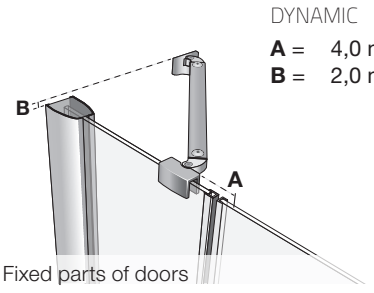
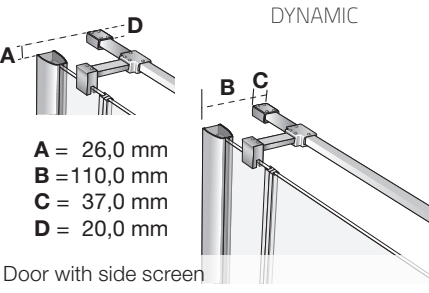
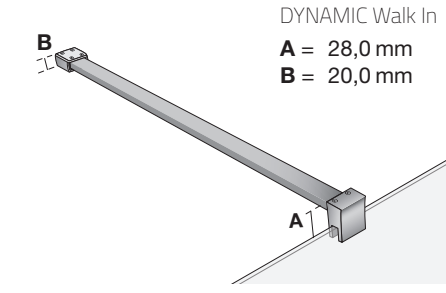
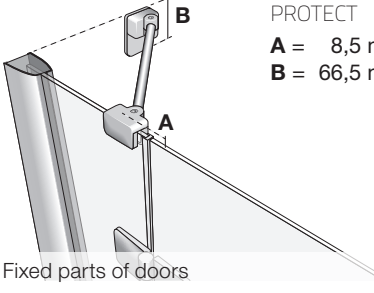
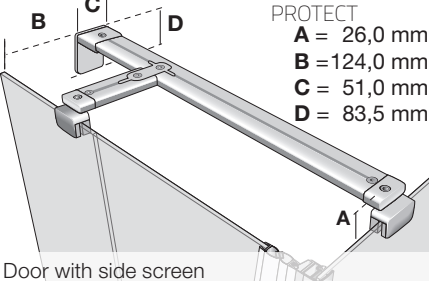
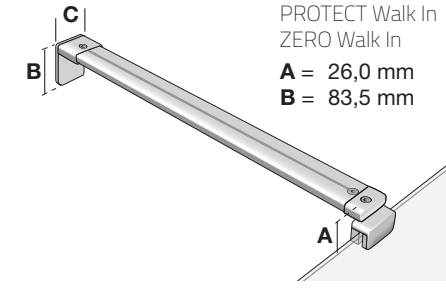
 <p>ARTWEGER 360 TWISTLINE  <b>A = 8,5 mm</b></p> <p>Fixed parts of doors</p>	 <p>ARTWEGER 360 TWISTLINE  <b>A = 26,0 mm</b>  <b>B = 17,5 mm</b></p> <p>ARTWEGER 360 Walk In, side screen and extra-wide fixed parts.</p>	 <p>ARTWEGER 360, TWISTLINE  <b>A = 26,0 mm</b>  <b>B = 124,0 mm</b>  <b>C = 51,0 mm</b>  <b>D = 17,5 mm</b></p> <p>Door with side screen</p>
 <p>ARTWEGER 360  <b>A = 8,5 mm</b></p> <p>Double folding door U-form assembly, single folding screen attached on fixed part extra wide - Special dimensions for when the swinging door swivels underneath the stabilizer</p>	 <p>ARTWEGER 360  <b>A = 26,0 mm</b>  <b>B = 124,0 mm</b>  <b>C = 51,0 mm</b></p> <p>Door with two side walls</p>	 <p>MOVE Walk In  <b>A = 61,0 mm</b>  <b>B = 49,0 mm</b></p>
 <p>DYNAMIC  <b>A = 4,0 mm</b>  <b>B = 2,0 mm</b></p> <p>Fixed parts of doors</p>	 <p>DYNAMIC  <b>A = 26,0 mm</b>  <b>B = 110,0 mm</b>  <b>C = 37,0 mm</b>  <b>D = 20,0 mm</b></p> <p>Door with side screen</p>	 <p>DYNAMIC Walk In  <b>A = 28,0 mm</b>  <b>B = 20,0 mm</b></p>
 <p>PROTECT  <b>A = 8,5 mm</b>  <b>B = 66,5 mm</b></p> <p>Fixed parts of doors</p>	 <p>PROTECT  <b>A = 26,0 mm</b>  <b>B = 124,0 mm</b>  <b>C = 51,0 mm</b>  <b>D = 83,5 mm</b></p> <p>Door with side screen</p>	 <p>PROTECT Walk In          ZERO Walk In  <b>A = 26,0 mm</b>  <b>B = 83,5 mm</b></p>

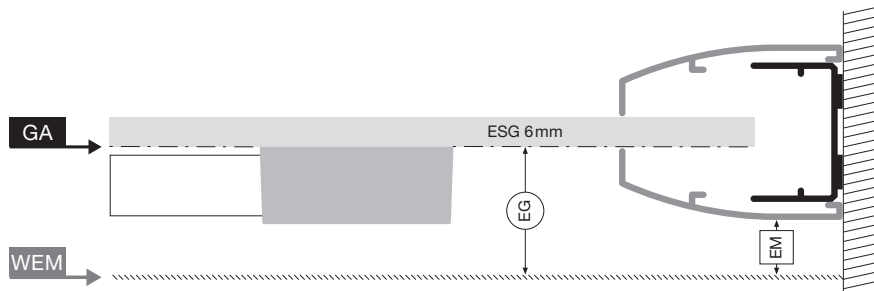

**Application ON SHOWER TRAY**

corner installation or installation on straight wall

**WEM** Outer edge of shower tray

This is the measured reference point for fitting ON THE SHOWER TRAY.

The measurement must be made from the tiled wall to the outer edge of the fully installed shower tray.

**These are the measurements for the tub installation (WEM).**

The adjustment ranges in the price list always refer to the shower tray installation measurement. You will find the exact shower-tray installation dimensions in mm at the respective products.

The adjustment range can only be fully utilised if the walls are vertical. For sloping walls, the adjustment range is used to compensate for the slope.

**EM** Offset measurement on shower tray

Factory determined measurement for the distance between the shower tray outer edge and the shower enclosure.

This enables the shower enclosure to be correctly positioned and sealed on the shower tray.

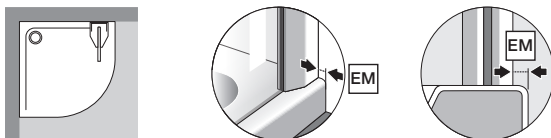

**Application WITHOUT SHOWER TRAY**

corner installation or installation on straight wall

**GA** Glass outer side

This is the measured reference point for fitting WITHOUT A SHOWER TRAY.

The measurement from the tiled wall to the desired position of the outer side of the glass. Measurement sketch needed.

As a rule, fitting WITHOUT A SHOWER TRAY requires a custom made shower enclosure. The width dimensions are always construed centrally in the factory to enable both a narrower and wider adjustment when installing

The adjustment range can only be fully utilised if the walls are vertical. For sloping walls, the adjustment range is used to compensate for the slope.

**EG** OPTIONAL: Offset measurement on the glass outer side of partly framed and framed shower partitions

The tub installation dimension stated for standard sizes applies to fitting ON the shower tray. Whether a standard size is suitable for fitting WITHOUT a shower tray can be determined as follows:

Firstly the on site measurement up to the desired position of the outer side of the glass.

**The distance measured + offset measurement of the outside glass (EG) = tray installation measurement (WEM)**

The calculated tub installation measurement (WEM) should be in the middle range of the tub installation measurements of the appropriate standard size. This allows for both narrower and wider adjustment when assembling.

The adjustment range can only be fully utilised if the walls are vertical. For sloping walls, the adjustment range is used to compensate for the slope.

Frameless shower enclosures are usually made to measure depending on the requirements of each situation. The above measurements are not applicable with these products.

# DETAILED MEASUREMENTS - PARTIALLY FRAMED SHOWER ENCLOSURES

ARTWEGER price list 03/2023. For specialised trade outlets only. DIMENSIONS IN MILLIMETRES.

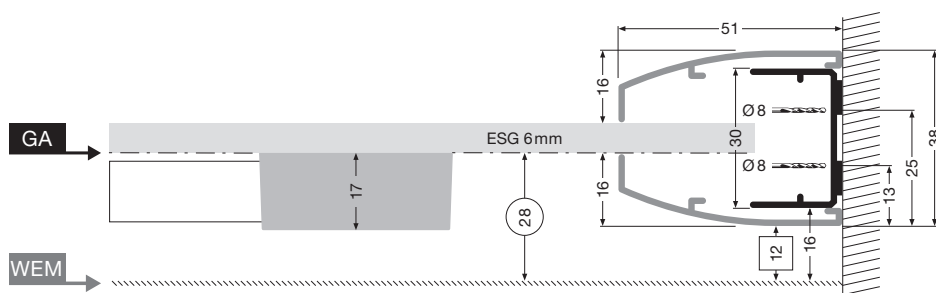

ARTWEGER 360  
partially framed  
with fixed part

Artweger DYNAMIC

BODY+SOUL  
partially framed

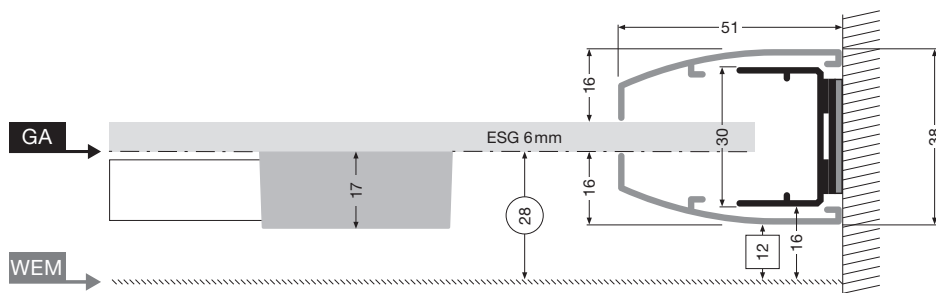

PROTECT

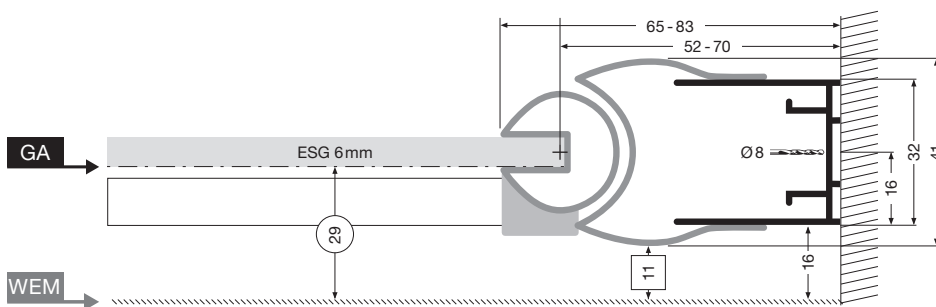

ARTWEGER 360  
partially framed  
without fixed part

TWISTLINE  
without fixed part

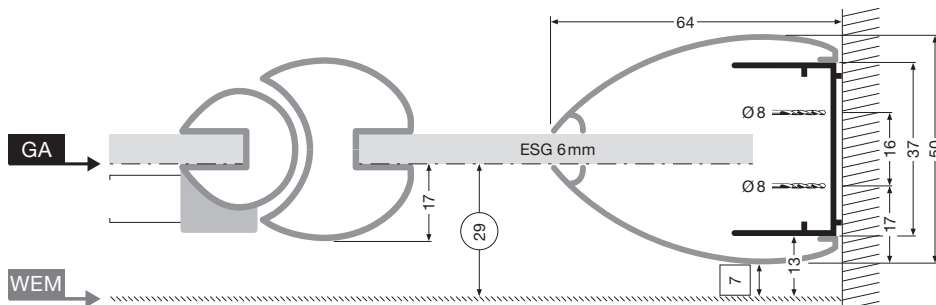

TWISTLINE  
with fixed part

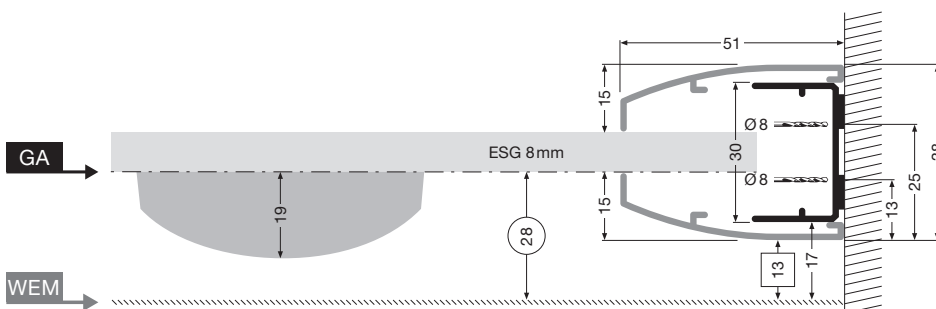

ARTWEGER 360 Walk In  
partially framed

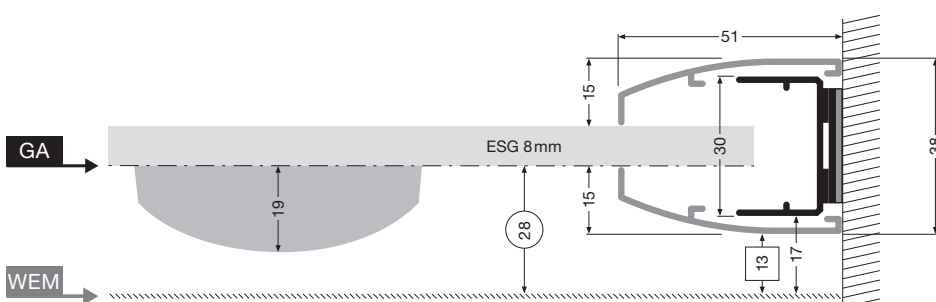

PROTECT Walk In

# Artweger® DETAILED MEASUREMENTS - PARTIALLY FRAMED SHOWER ENCLOSURES

ARTWEGER price list 03/2023. For specialised trade outlets only. DIMENSIONS IN MILLIMETRES.

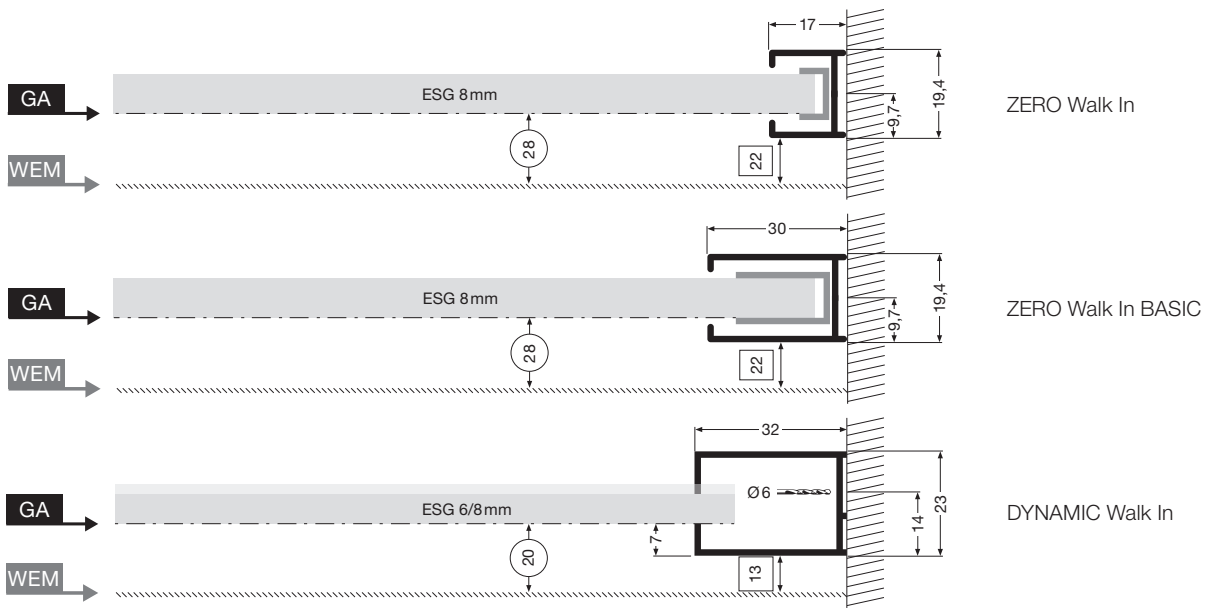

# DETAILED MEASUREMENTS - FRAMELESS SHOWER ENCLOSURES

ARTWEGER price list 03/2023. For specialised trade outlets only. DIMENSIONS IN MILLIMETRES.

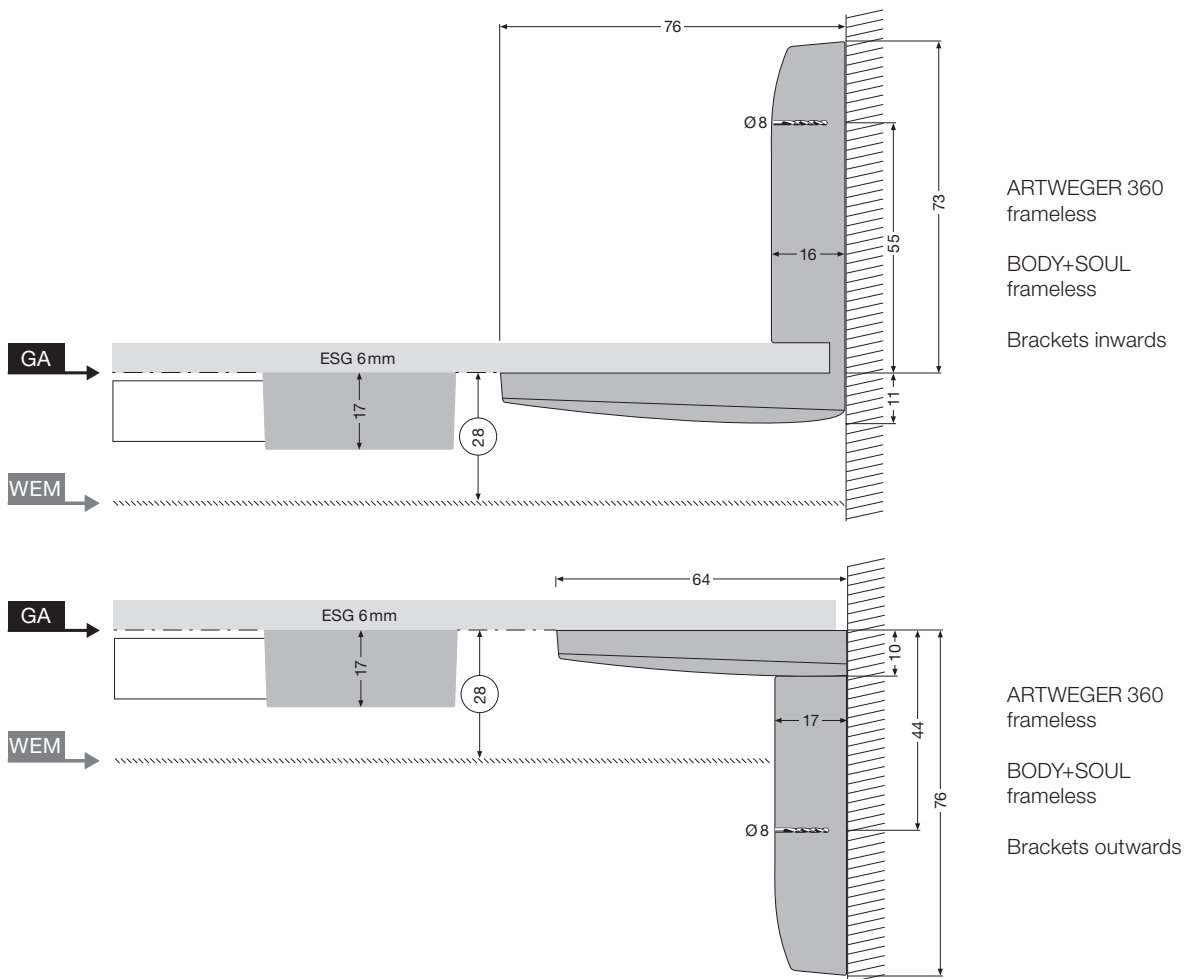



# DETAILED MEASUREMENTS - FRAMELESS SHOWER ENCLOSURES

ARTWEGER price list 03/2023. For specialised trade outlets only. DIMENSIONS IN MILLIMETRES.

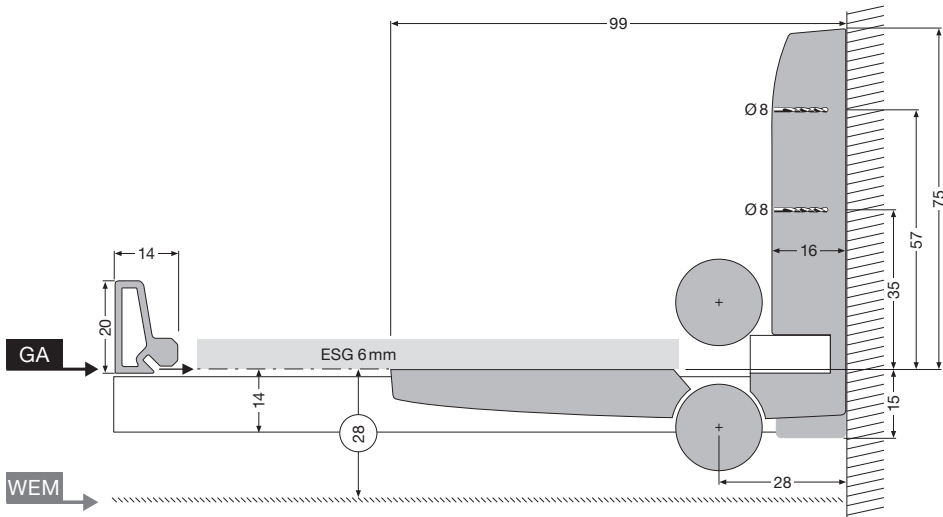

ARTWEGER 360  
frameless  
without fixed part

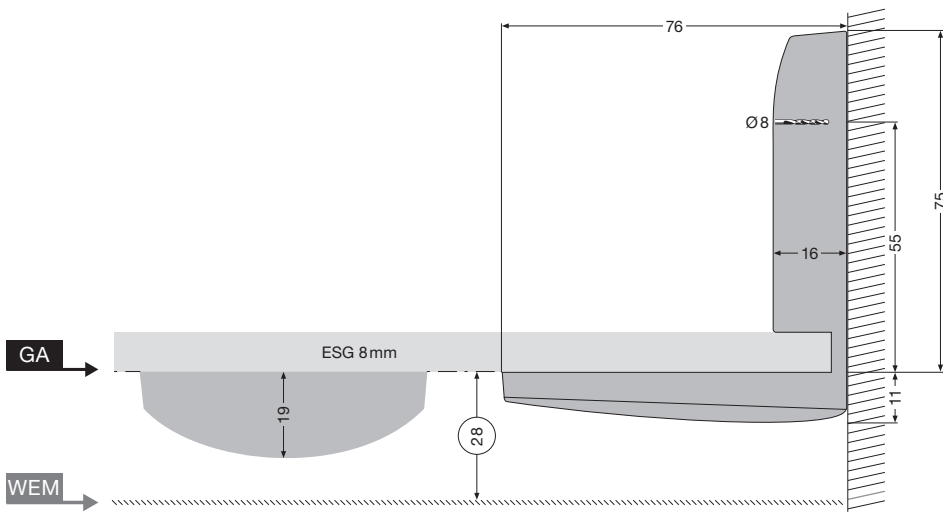

ARTWEGER 360 Walk In  
frameless  
Brackets inwards

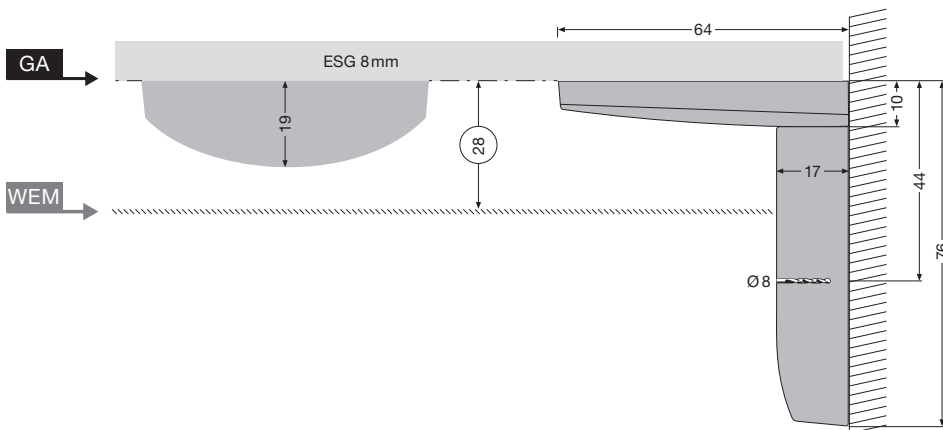

ARTWEGER 360 Walk In  
frameless  
Brackets outwards

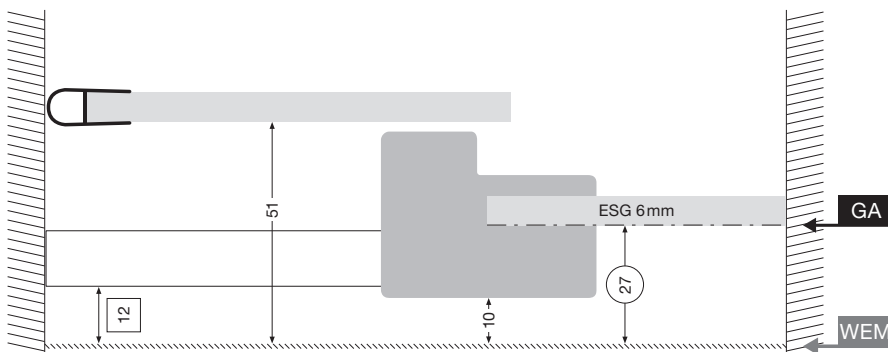

MOVE

# Artweger® DETAILED MEASUREMENTS - FRAMED SHOWER ENCLOSURES

ARTWEGER price list 03/2023. For specialised trade outlets only. DIMENSIONS IN MILLIMETRES.

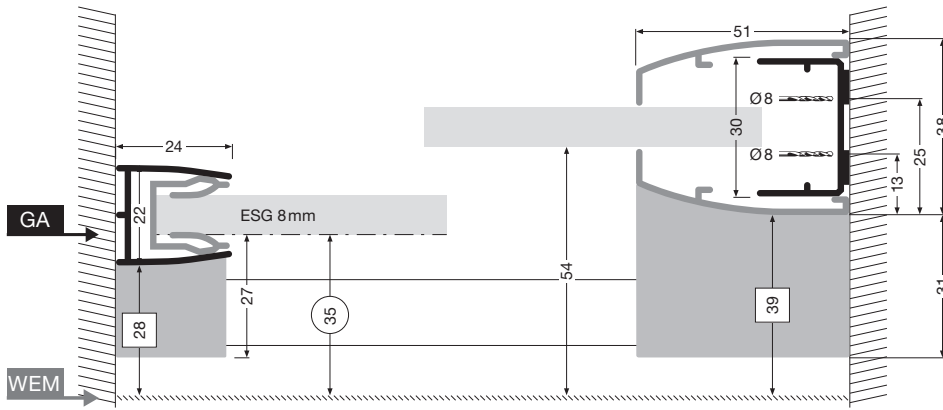

ARTWEGER 360 sliding doors

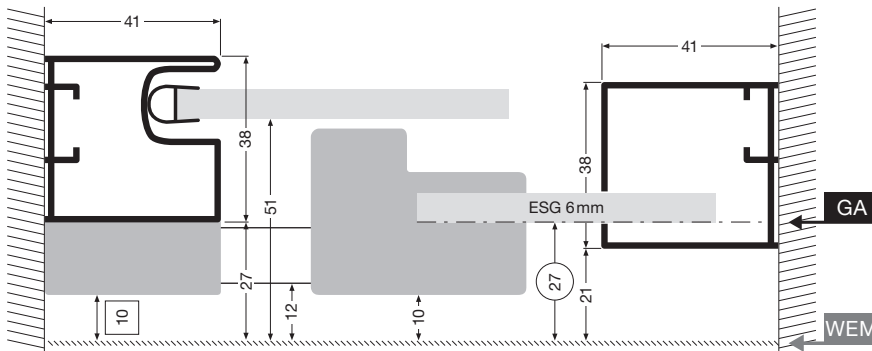

MOVE

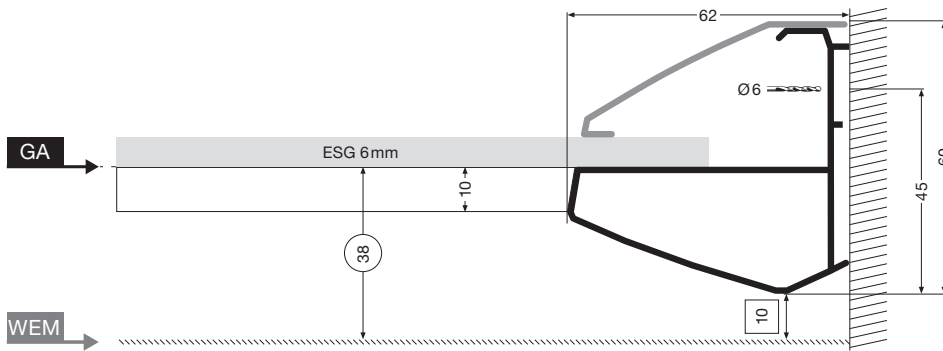

LIFELINE

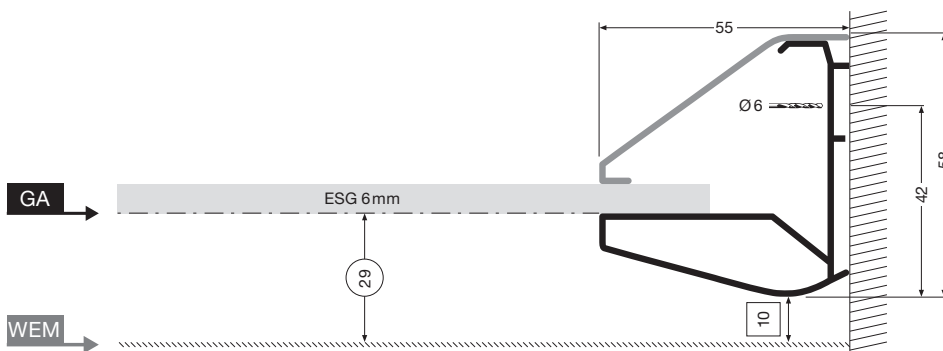

LIFELINE side screen

# DETAILED MEASUREMENTS - FRAMED SHOWER ENCLOSURES

ARTWEGER price list 03/2023. For specialised trade outlets only. DIMENSIONS IN MILLIMETRES.

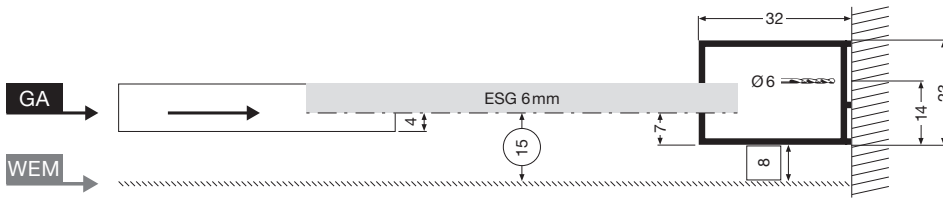

SLIDE  
1/4-round shower, corner entry

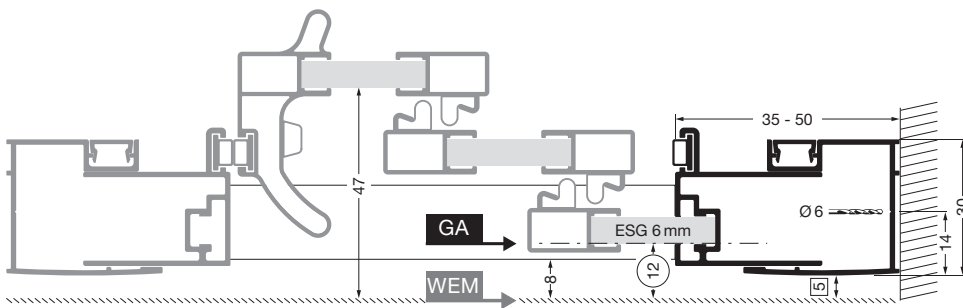

SLIDE  
triple sliding door

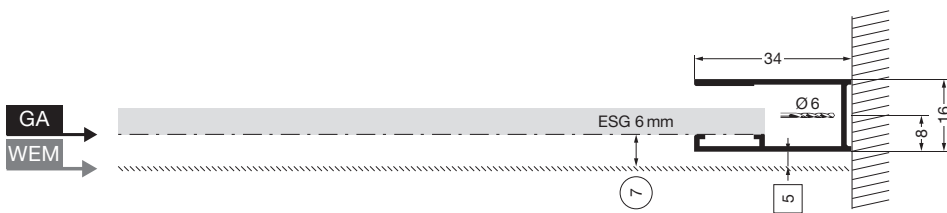

SLIDE  
side screen next to triple sliding door

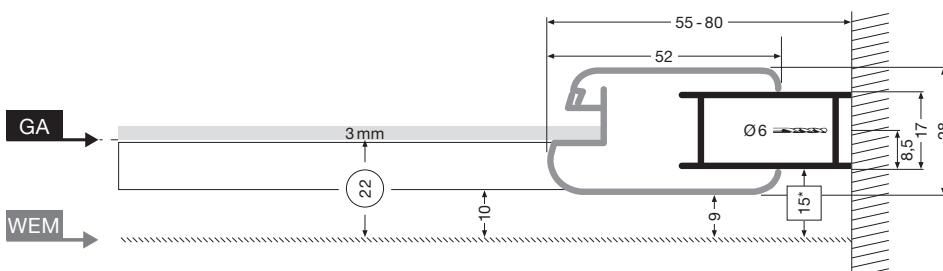

BASELINE  
\*side screen 10mm



# ARTWEGER 360 partially framed

Winged door / Side screen 6 mm ESG

ARTWEGER price list 03/2023. For specialised trade outlets only. Suggested retail prices in EUR not including VAT.  
DIMENSIONS IN MILLIMETRES.

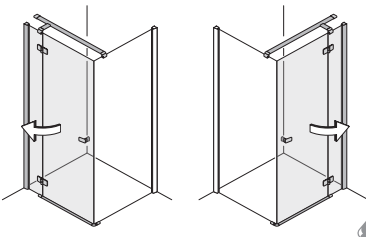
Hinge left	Hinge right	Height	Shower tray measurement (WM)	Shower tray installation measurement	Fixed part width Quantity stabilisers	Entrance width	
<b>Winged door</b> attached on fixed part next to side screen 		<b>2000</b>	800	780 - 800	145 - 165	1	580
			900	880 - 900	145 - 165	1	680
			1000	980 - 1000	245 - 265	1	680
			1200	1180 - 1200	445 - 465	1	680

Hinge always on the wall side. Incl. stabiliser for side screen.

**CUSTOM MEASUREMENTS** - Measurement sketch needed.

Height 1500 - 2200 mm. Shower tray installation measurement 700 - 1300 mm.

Door max. 750 mm.

**Surcharge for triangular and rectangular cut-outs as well as EXTRA WIDTHS up to 1800 mm.**



### Custom measurements

- Please check to see if your shower enclosure is in our standard programme.
- You can find the prices and measurement ranges for custom sizes along with respective product in the line for custom measurements.
- When ordering always state the measurements from outer edge of shower tray to tiled wall.
- For shower enclosures installed without a shower tray we must have a measurement sketch. The standard base installation measurement cannot be used for this installation variant.
- Please do not deduct any measurements, this will be done by us.
- The adjustment range of a custom enclosure is adapted to the respective situation and does not correspond to that of a standard model.
- The surcharges given for sloping and cut-outs are applicable providing they are technically possible. Surcharge added to price of custom sizes.
- Further custom sizes for solving special problem situations on inquiry. Please make a sketch.
- Custom sizes are manufactured to order. Therefore we cannot accept exchanges or returns.

The exact structure of the re-order number and the calculation of the total price is given on each page using a diagram. Here an example for the complete structure of an re-order number. By completely filling in the article number and the desired codes you obtain the entire re-order number.

By adding the base price and surcharge(s) you obtain the total price.



Art. no.	Frame colour	Glazing	Glass finishing (optional)	Handle type	Colour	Handle/hinge
9 T						
Base price			Surcharge			



WM	left	right	MH High-gloss metal WS White . . Additional colours	EK Glass clear RW Strip Satin SA Satin	C ARTCLEAR GLAZING	K Knob R Horizontal H Vertical G Bow-type T Towel holder	. . same as frame <sup>1</sup> VC Chrome
800	9T2F1 49	9T2F2 49	1,323	EK 0	211	K 0 R 0 H 0 G 166 T -	. . 0 VC 0
900	9T2F1 59	9T2F2 59					
1000	9T2F1 69	9T2F2 69	1,396	SA 351			
1200	9T2F1 B9	9T2F2 B9	1,536				
	9T2F1 88	9T2F2 88	1,646				
			322				
	⋮	⋮	⋮	⋮	⋮	⋮	⋮

**Art. no.**

The article number defines the desired article. Often there is a difference between execution on the left and right. If there is only one article number in the column "art. no." then the product can be installed on the left as well as on the right.

**Base price**

Depends on the chosen size and colour. The most common colours and their codes can be found in the column heading of the price group. For additional colours and their codes see page 4. If "-" is entered instead of a price, that means "not available".

**Surcharge**

For the desired equipment variation. Surcharges are to be added to the chosen basic price. The available features and their codes can be found in the column heading. If "-" is entered instead of a price, that means "not available". Various surcharges are allocated to the applicable codes. If one surcharge is valid for all selection possibilities, codes do not apply for prices.

The structure of the re-order number is not the same with every article. You can see which codes are needed for a re-order number on each page, based on the diagram.



# ARTWEGER 360 partially framed

Superior functionality.

- Winged doors and swinging doors with fixed parts
- Swinging doors with 360° TWIN hinge
- Barrier-free with Vario sealing system
- Certified adhesion technique
- Raise and lower mechanism
- Wall profile with 3D adjustment and concealed silicone joint
- 6 mm single-pane safety glass
- Standard height 2000 mm
- Adjustment range 20 mm
- Custom sizes available

## HANDLE TYPES

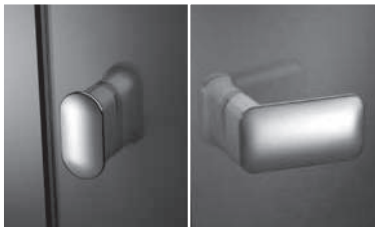

Knob **K**

Horizontal **R**

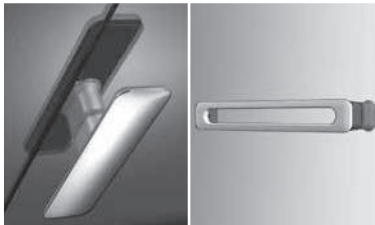

Vertical **H**

Bow-type **G**



Especially **EASY TO CLEAN**.



**SWINGING DOORS:** The doors can be opened up to 180° inwards and outwards.



Stabilizers match the design of the showers and provide great stability even in the case of large showers.



**Artweger**

artclear  
GLASS

**CE**

according to EN 14428

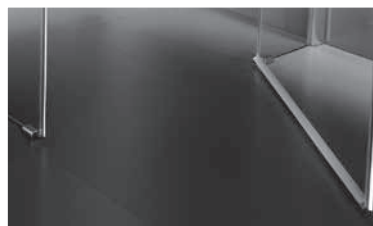

**VARIO sealing system:**  
You decide either for 100 %  
**FLUSH-TO-FLOOR ACCESS** or ...

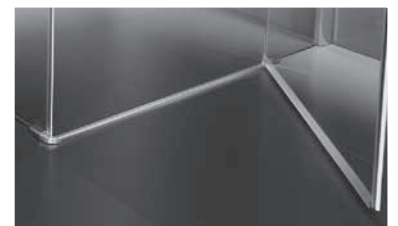

... for an optional surge bar which  
is only 12 mm high and provides  
**IMPROVED SEALING** of the door.

# ACCESSORIES

ARTWEGER price list 03/2023. For specialised trade outlets only.  
Suggested retail prices in EUR not including VAT. DIMENSIONS IN MILLIMETRES.

Art. no.				Colour	
9	0				
Base price					

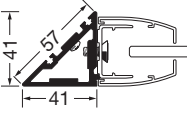
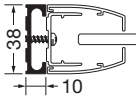
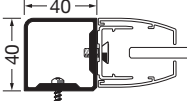
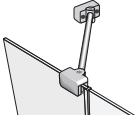
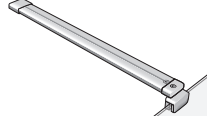
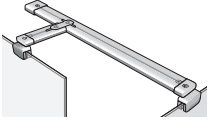
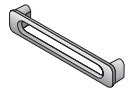
	Height / length	Art. no.	MH High-gloss metal WS White . . Additional colours
 <p><b>Mounting bracket, 45°</b> For installation on tiled walls under 45°. Necessary additional information: article number of the respective shower enclosure.</p>	2000	<b>90P 79</b>	259
	Custom size	<b>90P 78</b>	310
 <p><b>Compound bracket 10 mm</b> Extends adjustment range of all products by 10 mm. Necessary additional information: article number of the respective shower enclosure.</p>	2000	<b>90P 39</b>	162
	Custom size	<b>90P 38</b>	194
 <p><b>Mounting bracket</b> For attaching to wall projections. Necessary additional information: article number of the respective shower enclosure.</p>	2000	<b>90P 19</b>	259
	Custom size	<b>90P 18</b>	310
 <p><b>Stabiliser</b> Fits quarter-round and pentagonal shower, doors and corner entry.</p>	ca. 300	<b>900 41</b>	158
	ca. 430	<b>900 42</b>	172
 <p><b>Side-screen stabiliser</b> Length has to be adjusted on site.</p>	ca. 1200	<b>900 44</b>	183
 <p><b>T-Stabilizer</b> Length has to be adjusted on site.</p>	ca. 1200	<b>900 46</b>	247
	Width	Art. no.	VC Chrome WS White . . Additional colours
 <p><b>Towel holder</b> For installation on tiled walls.</p>	550	<b>900 11</b>	252

ARTWEGER 360  
partially framed

## LEFT/RIGHT in the case of an asymmetric shower tray

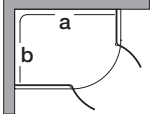
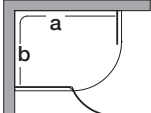
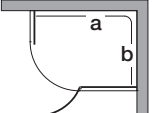
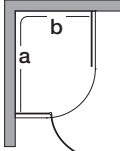
<p>LEFT</p> <p><b>9TRF1 A9</b> <b>9TRF1 C9</b> <b>9TRP1 A9</b> <b>9TRP1 C9</b></p>			<p>RIGHT</p> <p><b>9TRF2 A9</b> <b>9TRF2 C9</b> <b>9TRP2 A9</b> <b>9TRP2 C9</b></p>
<p>LEFT</p> <p><b>9T8F1 B9</b> <b>9T8F1 D9</b></p> <p>Door on wide fixed part</p>			<p>RIGHT</p> <p><b>9T8F2 B9</b> <b>9T8F2 D9</b></p> <p>Door on wide fixed part</p>
	<p>LEFT</p> <p><b>9T8F1 S9</b> <b>9T8F1 T9</b></p> <p>Door on narrow fixed part</p>		<p>RIGHT</p> <p><b>9T8F2 S9</b> <b>9T8F2 T9</b></p> <p>Door on narrow fixed part</p>

### IMPORTANT

- We will gladly send you the documents in hard copy on request.

# ARTWEGER 360 partially framed

Winged door 6 mm ESG

ARTWEGER price list 03/2023. For specialised trade outlets only. Suggested retail prices in EUR not including VAT.  
DIMENSIONS IN MILLIMETRES.

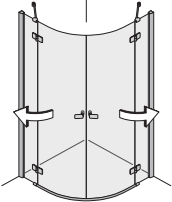
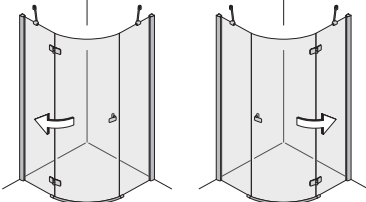
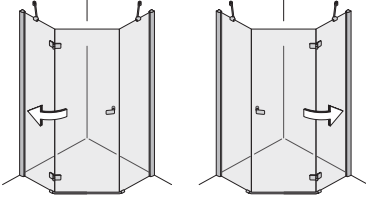
Hinge left	Hinge right	Height	Shower tray measurement (WM) length a x width b	Shower tray installation measurement	Fixed part width Quantity stabilisers	Entrance width
<b>1/4-round shower</b>		<b>2000</b>	800 x 800 I R=500	780 - 800	140 - 160 -	850
			900 x 900 I R=500	880 - 900	240 - 260 2	850
2 winged doors and 2 fixed parts			900 x 900 II R=550	880 - 900	140 - 160 -	990
			1000 x 1000 II R=550	980 - 1000	240 - 260 2	990
			900 x 800 I R=500	880 - 900 x 780 - 800	240 - 260 x 140 - 160 1	850
			1000 x 900 II R=550	980 - 1000 x 880 - 900	240 - 260 x 140 - 160 1	990
<b>CUSTOM MEASUREMENTS</b> - Measurement sketch needed. fixed-part custom width (narrower or wider). Width max. 1200 x 1200 mm. Custom heights not available. <b>Surcharge for triangular and rectangular cut-outs.</b>						
<b>1/4-round shower</b>		<b>2000</b>	800 x 800 I R=500	780 - 800	315 - 335 1	600
			900 x 900 I R=500	880 - 900	415 - 435 1	600
1 winged door and 2 fixed parts			900 x 900 II R=550	880 - 900	375 - 395 1	650
			1000 x 1000 I R=500	980 - 1000	515 - 535 2	600
			1000 x 1000 II R=550	980 - 1000	475 - 495 2	650
			900 x 800 I R=500	880 - 900 x 780 - 800	415 - 435 x 315 - 335 1	600
					Door on wide fixed part	
			900 x 800 I R=500	880 - 900 x 780 - 800	415 - 435 x 315 - 335 1	600
					Door on narrow fixed part	
1000 x 900 II R=550	980 - 1000 x 880 - 900	475 - 495 x 375 - 395 1	650			
		Door on wide fixed part				
1000 x 900 II R=550	980 - 1000 x 880 - 900	475 - 495 x 375 - 395 2	650			
		Door on narrow fixed part				
<b>CUSTOM MEASUREMENTS</b> - Measurement sketch needed. fixed-part custom width (narrower or wider). Width max. 1200 x 1200 mm. Custom heights not available. <b>Surcharge for triangular and rectangular cut-outs.</b>						
<b>Pentagonal shower</b>		<b>2000</b>	900 x 900 I M=707	880 - 900	365 - 385 1	660
			900 x 900 IV M=636	880 - 900	415 - 435 1	590
1 winged door and 2 fixed parts			1000 x 1000 I M=707	980 - 1000	465 - 485 2	660
			1000 x 1000 IV M=636	980 - 1000	515 - 535 2	590
<b>CUSTOM MEASUREMENTS</b> - Measurement sketch needed. Height 1500 - 2200 mm. fixed-part custom width (narrower or wider). <b>Surcharge for triangular and rectangular cut-outs.</b>						

## IMPORTANT

- With stabiliser: required installation height ist total height + 100 mm.  
Without stabiliser: required installation height is total height + 30 mm.
- When ordering please indicate assembly on shower tray or flush with floor.



Art. no.		Frame colour	Glazing	Glass finishing (optional)	Handle type	Colour Handle/hinge
9 T						
Base price			Surcharge			
WM	left	right	MH High-gloss metal WS White . . Additional colours	EK Glass clear RW Strip Satin SA Satin	C ARTCLEAR GLAZING	K Knob R Horizontal H Vertical G Bow-type . . same as frame <sup>1</sup> VC Chrome
800I	9TRF0 49		2,759			
900I	9TRF0 19		2,805			
900II	9TRF0 29		2,805	EK 0	417	K 0 R 0 H 0 G -
1000II	9TRF0 69		2,983	RW -		VC 0
900/800I	9TRF1 A9	9TRF2 A9	2,805	SA -		
1000/900II	9TRF1 C9	9TRF2 C9	2,983			
	9TRF0 88		3,243			
			322			
800I	9T8F1 49	9T8F2 49	2,759			
900I	9T8F1 19	9T8F2 19	2,805			
900II	9T8F1 29	9T8F2 29	2,805			
1000I	9T8F1 E9	9T8F2 E9	2,983			
1000II	9T8F1 69	9T8F2 69	2,983	EK 0	417	K 0 R 0 H 0 G -
900/800I	9T8F1 B9	9T8F2 B9	2,805	RW -		VC 0
900/800I	9T8F1 S9	9T8F2 S9	2,805	SA -		
1000/900II	9T8F1 D9	9T8F2 D9	2,983			
1000/900II	9T8F1 T9	9T8F2 T9	2,983			
	9T8F1 88	9T8F2 88	3,243			
			322			
900I	9T7F1 59	9T7F2 59	2,592			
900IV	9T7F1 39	9T7F2 39	2,592	EK 0	417	K 0 R 0 H 0 G 166
1000I	9T7F1 69	9T7F2 69	2,724	RW 390		VC 0
1000IV	9T7F1 99	9T7F2 99	2,724	SA 677		
	9T7F1 88	9T7F2 88	2,983			
			322			

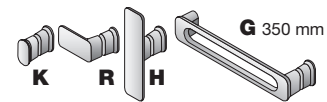

ARTWEGER 360  
partially framed

### IMPORTANT

- The manufacture of individually curved glass is not possible. Dimension tolerances to the tiled shower area are possible for technical reasons.

<sup>1</sup> Only VC chrome-plated available with MH high-gloss metal frames.

# ARTWEGER 360 partially framed

Winged door 6 mm ESG

ARTWEGER price list 03/2023. For specialised trade outlets only. Suggested retail prices in EUR not including VAT.  
DIMENSIONS IN MILLIMETRES.

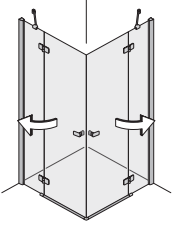
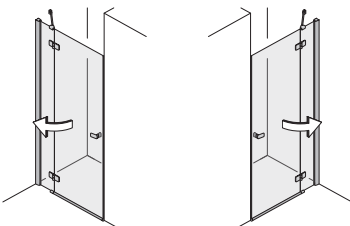
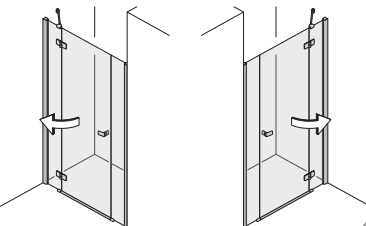
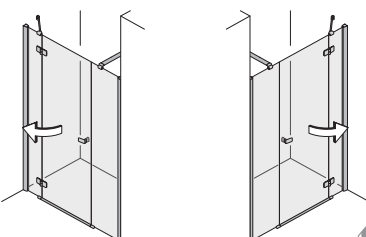
Hinge left	Hinge right	Height	Shower tray measurement (WM) length a x width b	Shower tray installation measurement	Fixed part width Quantity stabilisers	Entrance width	
<b>Corner entry</b> 		2000	800 x 800	780 - 800	240 - 260 2	700	
2 winged doors and 2 fixed parts <b>CUSTOM MEASUREMENTS</b> - Measurement sketch needed. Height 1500 - 2200 mm. Shower tray installation measurement 700 - 1200 mm. Price for combination of custom and standard measurement: (custom price + standard price) / 2. <b>Surcharge for triangular and rectangular cut-outs as well as EXTRA WIDTHS up to 1600x1600 mm.</b>			900 x 900	880 - 900	240 - 260 2	840	
			left	900 x 750	880 - 900 x 730 - 750	240 - 260 x 190 - 210 1	770
				750 x 900	730 - 750 x 880 - 900	190 - 210 x 240 - 260 1	770
			right	900 x 800	880 - 900 x 780 - 800	240 - 260 x 240 - 260 2	770
				800 x 900	780 - 800 x 880 - 900	240 - 260 x 240 - 260 2	770
			1000 x 1000	980 - 1000	340 - 360 2	840	
		<b>Winged door attached on fixed part in alcove</b> 		2000	750	730 - 750	150 - 170 -
1 door part and 1 fixed part <b>CUSTOM MEASUREMENTS</b> - Measurement sketch needed. Height 1500 - 2200 mm. Shower tray installation measurement 700 - 1200 mm. Door max. 750 mm. One stabiliser included with widths 1000 mm and wider. <b>Surcharge for triangular and rectangular cut-outs as well as EXTRA WIDTHS up to 1800 mm.</b>		800	780 - 800		150 - 170 -	580	
		900	880 - 900		150 - 170 -	680	
		1000	980 - 1000		250 - 270 1	680	
		<b>Winged door attached on fixed part in alcove</b> 		2000	900	860 - 900	150 - 170 -
1 door part and 2 fixed parts <b>CUSTOM MEASUREMENTS</b> - Measurement sketch needed. Height 1500 - 2200 mm. Shower tray installation measurement 900 - 1400 mm. Door max. 750 mm. One stabiliser included with widths 1200 mm and wider. <b>Surcharge for triangular and rectangular cut-outs.</b>		1000	960 - 1000		150 - 170 -	630	
		1200	1160 - 1200		250 - 270 1	630	
		<b>Winged door attached on fixed part in alcove extra wide</b> 		2000	1400	1360 - 1400	250 - 270 / 400 - 420 1
1 door part and 2 fixed parts <b>CUSTOM MEASUREMENTS</b> - Measurement sketch needed. Height 1500 - 2200 mm. Shower tray installation measurement 1400 - 2000 mm. Door max. 750 mm. <b>Surcharge for triangular and rectangular cut-outs.</b>		1500	1460 - 1500		250 - 270 / 500 - 520 2	680	
		1600	1560 - 1600		250 - 270 / 600 - 620 2	680	
		1700	1660 - 1700		250 - 270 / 700 - 720 2	680	
		1800	1760 - 1800		250 - 270 / 800 - 820 2	680	
		Stabiliser 1200 mm. Length must be adjusted on site.					

## IMPORTANT

- With stabiliser: required installation height ist total height + 100 mm.  
Without stabiliser: required installation height is total height + 30 mm.

Art. no.		Frame colour	Glazing	Glass finishing (optional)	Handle type	Colour	Handle/hinge
9 T							
Base price				Surcharge			
WM	left	right	MH High-gloss metal WS White . . Additional colours	EK Glass clear RW Strip Satin SA Satin	C ARTCLEAR GLAZING	K Knob R Horizontal H Vertical G Bow-type	. . same as frame <sup>1</sup> VC Chrome
800	9TEF0 49		2,238	EK 0 RW 518 SA 692	417	K 0 R 0 H 0 G 331	. . 0 VC 0
900	9TEF0 59						
900/750	9TEF0 D9						
750/900	9TEF0 C9						
900/800	9TEF0 99						
800/900	9TEF0 79						
1000	9TEF0 69		2,554				
	9TEF0 88		2,765				
			322				
750	9T5F1 39	9T5F2 39	1,363	EK 0 RW 259 SA 351	211	K 0 R 0 H 0 G 166	. . 0 VC 0
800	9T5F1 49	9T5F2 49	1,371				
900	9T5F1 59	9T5F2 59	1,385				
1000	9T5F1 69	9T5F2 69	1,419				
	9T5F1 88	9T5F2 88	1,646				
			322				
900	9T4F1 59	9T4F2 59	1,536	EK 0 RW 259 SA 351	211	K 0 R 0 H 0 G 166	. . 0 VC 0
1000	9T4F1 69	9T4F2 69	1,572				
1200	9T4F1 B9	9T4F2 B9	1,697				
	9T4F1 88	9T4F2 88	1,910				
			322				
1400	9T4F3 E9	9T4F4 E9	1,922	EK 0 RW 461 SA 692	417	K 0 R 0 H 0 G 166	. . 0 VC 0
1500	9T4F3 H9	9T4F4 H9	2,018				
1600	9T4F3 K9	9T4F4 K9	2,210				
1700	9T4F3 M9	9T4F4 M9	2,437				
1800	9T4F3 P9	9T4F4 P9	2,490				
	9T4F3 88	9T4F4 88	2,663				
			322				

ARTWEGER 360  
partially framed

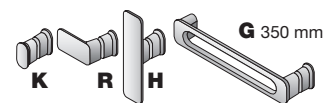

**IMPORTANT**

- When ordering please indicate assembly on shower tray or flush with floor.
- <sup>1</sup> Only VC chrome-plated available with MH high-gloss metal frames.

# ARTWEGER 360 partially framed

Winged door / Side screen 6 mm ESG

ARTWEGER price list 03/2023. For specialised trade outlets only. Suggested retail prices in EUR not including VAT.  
DIMENSIONS IN MILLIMETRES.

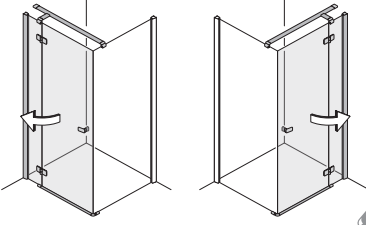
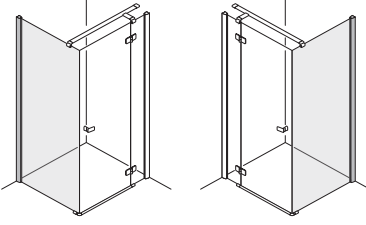
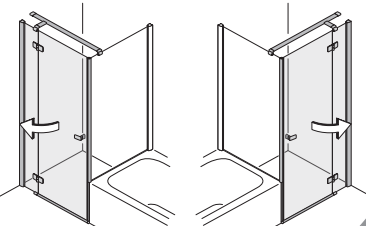
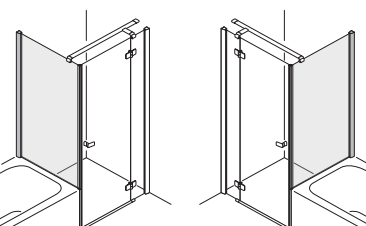
Hinge left	Hinge right	Height	Shower tray measurement (WM)	Shower tray installation measurement	Fixed part width Quantity stabilisers	Entrance width	
<b>Winged door attached on fixed part next to side screen</b>  1 door part and 1 fixed part		<b>2000</b>	800	780 - 800	145 - 165	1	580
	900		880 - 900	145 - 165	1	680	
	1000		980 - 1000	245 - 265	1	680	
	1200		1180 - 1200	445 - 465	1	680	
Hinge always on the wall side. Stabiliser 1200 mm. Length must be adjusted on site.							
<b>CUSTOM MEASUREMENTS</b> - Measurement sketch needed. Height 1500 - 2200 mm. Shower tray installation measurement 700 - 1300 mm. Door max. 750 mm. <b>Surcharge for triangular and rectangular cut-outs as well as EXTRA WIDTHS up to 1800 mm.</b>							
<b>Side screen next to winged door</b> 		<b>2000</b>	800	780 - 800	-	-	-
	900		880 - 900	-	-	-	
	1000		980 - 1000	-	-	-	
<b>CUSTOM MEASUREMENTS</b> - Measurement sketch needed. Height 1500 - 2200 mm. Shower tray installation measurement 200 - 1200 mm. <b>Surcharge for triangular and rectangular cut-outs as well as EXTRA WIDTHS up to 1800 mm.</b>							
<b>Winged door attached on fixed part next to shortened side screen</b>  1 door part and 1 fixed part		<b>2000</b>	800	780 - 800	150 - 170	1	580
	900		880 - 900	150 - 170	1	680	
	1000		980 - 1000	250 - 270	1	680	
Hinge always on the wall side. Stabiliser 1200 mm. Length must be adjusted on site.							
<b>CUSTOM MEASUREMENTS</b> - Measurement sketch needed. Height 1500 - 2200 mm. Shower tray installation measurement 700 - 1300 mm. Door max. 750 mm. <b>Surcharge for triangular and rectangular cut-outs as well as EXTRA WIDTHS up to 1800 mm.</b>							
<b>Shortened side screen</b> 		<b>CUSTOM MEASUREMENTS</b> - Measurement sketch needed. Fits winged door or swinging door. Height 1000 - 2200 mm. Shower tray installation measurement 200 - 1200 mm.			-	-	-
<b>Surcharge for triangular and rectangular cut-outs as well as EXTRA WIDTHS up to 1800 mm.</b>							

**IMPORTANT**

- Required installation height is total height + 100 mm.
- Hinge always on the wall side.

Art. no.		Frame colour	Glazing	Glass finishing (optional)	Handle type/ towel holder	Colour Handle/hinge/ towel holder	
9 T							
Base price			Surcharge				
WM	left	right	MH High-gloss metal WS White . . Additional colours	EK Glass clear RW Strip Satin SA Satin	C ARTCLEAR GLAZING	K Knob R Horizontal H Vertical G Bow-type T Towel holder	. . same as frame <sup>1</sup> VC Chrome
800	9T2F1 49	9T2F2 49	1,323	EK 0 RW 259 SA 351	211	K 0 R 0 H 0 G 166 T -	. . 0 VC 0
900	9T2F1 59	9T2F2 59					
1000	9T2F1 69	9T2F2 69					
1200	9T2F1 B9	9T2F2 B9					
	9T2F1 88	9T2F2 88	1,646				
			322				
800	9T1F1 49	9T1F2 49	882	EK 0 RW 204 SA 351	211	K - R - H - G - T 252	. . 0 VC 0
900	9T1F1 59	9T1F2 59					
1000	9T1F1 69	9T1F2 69					
	9T1F1 88	9T1F2 88	1,087				
			322				
800	9T3F1 49	9T3F2 49	1,385	EK 0 RW 259 SA 351	211	K 0 R 0 H 0 G 166 T -	. . 0 VC 0
900	9T3F1 59	9T3F2 59					
1000	9T3F1 69	9T3F2 69					
	9T3F1 88	9T3F2 88	1,646				
			322				
	9T601 88	9T602 88	989	EK 0 RW 204 SA 351	211	K - R - H - G - T 252	. . 0 VC 0
			322				

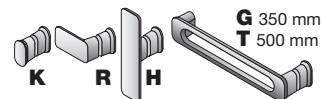

ARTWEGER 360  
partially framed

### IMPORTANT

- When ordering please indicate assembly on shower tray or flush with floor.
- <sup>1</sup> Only VC chrome-plated available with MH high-gloss metal frames.

# ARTWEGER 360 partially framed

Winged door / Side screen 6 mm ESG

ARTWEGER price list 03/2023. For specialised trade outlets only. Suggested retail prices in EUR not including VAT.  
DIMENSIONS IN MILLIMETRES.

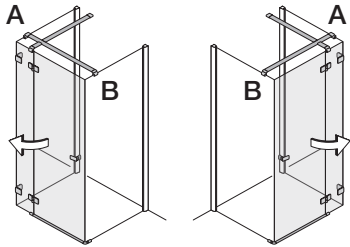
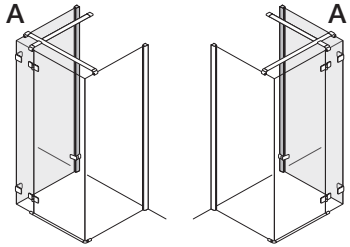
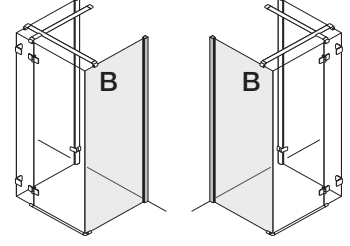
Hinge left	Hinge right	Height	Shower tray measurement (WM)	Shower tray installation measurement	Fixed part width Quantity stabilisers	Entrance width	
<b>Winged door attached on fixed part for two side screens</b> 		<b>2000</b>	900	900	135	1	680
	1000		1000	235	1	680	
Including stabiliser for side screens.							
<b>CUSTOM MEASUREMENTS - Measurement sketch needed.</b> Height 1500 - 2200 mm. Shower tray installation measurement 700 - 1400 mm. Door max. 750 mm.							
<b>1 door part and 1 fixed part</b>							
<b>Side screen A next to winged door</b> 		<b>2000</b>	900	880 - 900	-	-	-
	1000		980 - 1000	-	-	-	
<b>CUSTOM MEASUREMENTS - Measurement sketch needed.</b> Height 1500 - 2200 mm. Shower tray installation measurement 700 - 1200 mm.							
<b>Surcharge for triangular and rectangular cut-outs.</b>							
<b>Side screen B next to winged door</b> 		<b>2000</b>	900	880 - 900	-	-	-
	1000		980 - 1000	-	-	-	
<b>CUSTOM MEASUREMENTS - Measurement sketch needed.</b> Height 1500 - 2200 mm. Shower tray installation measurement 700 - 1200 mm.							
<b>Surcharge for triangular and rectangular cut-outs.</b>							

## IMPORTANT

Art. no.		Frame colour	Glazing	Glass finishing (optional)	Handle type/ towel holder	Colour Handle/hinge/ towel holder	
9 T							
Base price			Surcharge				
WM	left	right	MH High-gloss metal WS White . . Additional colours	EK Glass clear RW Strip Satin SA Satin	C ARTCLEAR GLAZING	K Knob R Horizontal H Vertical G Bow-type T Towel holder	. . same as frame <sup>1</sup> VC Chrome
900	9TGF1 59	9TGF2 59	1,323	EK 0	211	K 0 R 0 H 0	. . 0
1000	9TGF1 69	9TGF2 69	1,396	RW 259 SA 351		G 166 T -	VC 0
	9TGF1 88	9TGF2 88	1,646				
900	9TH01 59	9TH02 59	882	EK 0	211	K - R - H -	. . 0
1000	9TH01 69	9TH02 69	932	RW 204 SA 351		G - T 252	VC 0
	9TH01 88	9TH02 88	1,087				
			322				
900	9T1F2 59	9T1F1 59	882	EK 0	211	K - R - H -	. . 0
1000	9T1F2 69	9T1F1 69	932	RW 204 SA 351		G - T 252	VC 0
	9T1F2 88	9T1F1 88	1,087				
			322				

ARTWEGER 360  
partially framed

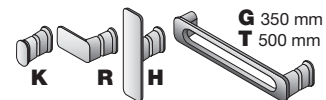

### IMPORTANT

- When ordering please indicate assembly on shower tray or flush with floor.
- <sup>1</sup> Only VC chrome-plated available with MH high-gloss metal frames.

# ARTWEGER 360 partially framed

Swinging door 6 mm ESG

ARTWEGER price list 03/2023. For specialised trade outlets only. Suggested retail prices in EUR not including VAT.  
DIMENSIONS IN MILLIMETRES.

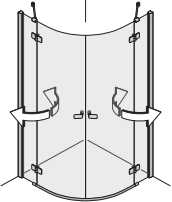
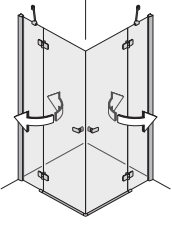
Hinge left	Hinge right	Height	Shower tray measurement (WM) length a x width b	Shower tray installation measurement	Fixed part width Quantity stabilisers	Entrance width
<b>1/4-round shower</b>						
		<b>2000</b>	<b>800 x 800 I</b> R=500	780 - 800	140 - 160 -	860
			<b>900 x 900 I</b> R=500	880 - 900	240 - 260 2	860
			<b>900 x 900 II</b> R=550	880 - 900	140 - 160 -	1000
			<b>1000 x 1000 II</b> R=550	980 - 1000	240 - 260 2	1000
			<b>900 x 800 I</b> R=500	880 - 900 x 780 - 800	240 - 260 x 140 - 160 1	860
			<b>1000 x 900 II</b> R=550	980 - 1000 x 880 - 900	240 - 260 x 140 - 160 1	1000
<p><b>CUSTOM MEASUREMENTS</b> - Measurement sketch needed. fixed-part custom width (narrower or wider). Width max. 1200 x 1200 mm. Custom heights not available.</p> <p><b>Surcharge for triangular and rectangular cut-outs.</b></p>						
<b>Corner entry</b>						
		<b>2000</b>	<b>800 x 800</b>	780 - 800	240 - 260 2	710
			<b>900 x 900</b>	880 - 900	240 - 260 2	850
			<b>900 x 750</b>	880 - 900 x 730 - 750	240 - 260 x 190 - 210 1	780
			<b>750 x 900</b> left	730 - 750 x 880 - 900	190 - 210 x 240 - 260 1	780
			<b>900 x 800</b> right	880 - 900 x 780 - 800	240 - 260 x 240 - 260 2	780
			<b>800 x 900</b>	780 - 800 x 880 - 900	240 - 260 x 240 - 260 2	780
			<b>1000 x 1000</b>	980 - 1000	340 - 360 2	850
<p><b>CUSTOM MEASUREMENTS</b> - Measurement sketch needed. Height 1800 - 2200 mm. Shower tray installation measurement 700 - 1200 mm. Price for combination of custom and standard measurement: (custom price + standard price) / 2.</p> <p><b>Surcharge for triangular and rectangular cut-outs as well as EXTRA WIDTHS up to 1600 x 1600 mm.</b></p>						

## IMPORTANT

- With stabiliser: required installation height ist total height + 100 mm.  
Without stabiliser: required installation height is total height + 30 mm.
- When ordering please indicate assembly on shower tray or flush with floor.



Art. no.		Frame colour	Glazing	Glass finishing (optional)	Handle type	Colour Handle/hinge	
9 T							
Base price			Surcharge				
WM	left right	MH High-gloss metal WS White . . Additional colours	EK Glass clear RW Strip Satin SA Satin	C ARTCLEAR GLAZING	K Knob R Horizontal H Vertical G Bow-type	. . same as frame <sup>1</sup> VC Chrome	
800I	9TRP049	2,816					
900I	9TRP019	2,861	EK 0	417	K 0	. . 0	
900II	9TRP029		RW -		R 0		VC 0
1000II	9TRP069	3,039	SA -		H 0		
900/800I	9TRP1 A9   9TRP2 A9	2,861			G -		
1000/900II	9TRP1 C9   9TRP2 C9	3,039					
	9TRP088	3,299					
		322					
800	9TEP049	2,294	EK 0	417	K 0	. . 0	
900	9TEP059		RW 518		R 0		VC 0
900/750	9TEP0 D9		SA 692		H 0		
750/900	9TEP0 C9				G 331		
900/800	9TEP099						
800/900	9TEP079	2,609					
1000	9TEP069	2,821					
	9TEP088	322					

ARTWEGER 360  
partially framed

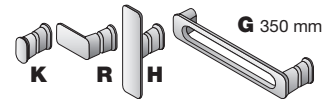

### IMPORTANT

- The manufacture of individually curved glass is not possible. Dimension tolerances to the tiled shower area are possible for technical reasons.

<sup>1</sup> Only VC chrome-plated available with MH high-gloss metal frames.

# ARTWEGER 360 partially framed

Swinging door 6 mm ESG

ARTWEGER price list 03/2023. For specialised trade outlets only. Suggested retail prices in EUR not including VAT.  
DIMENSIONS IN MILLIMETRES.

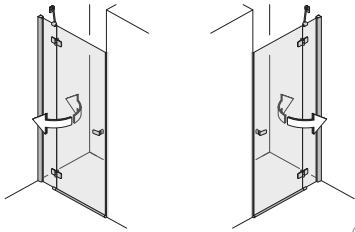
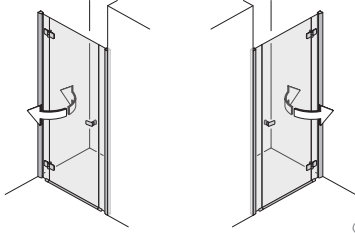
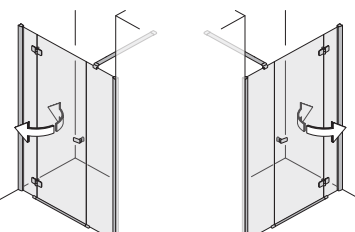
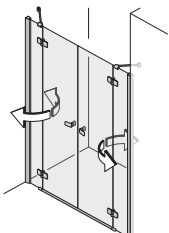
Hinge left	Hinge right	Height	Shower tray measurement (WM)	Shower tray installation measurement	Fixed part width Quantity stabilisers	Entrance width	
<b>Swinging door attached on fixed part in alcove</b> 		<b>2000</b>	750	730 - 750	150 - 170	-	530
			800	780 - 800	150 - 170	-	580
			900	880 - 900	150 - 170	-	680
			1000	980 - 1000	250 - 270	1	680
<b>CUSTOM MEASUREMENTS</b> - Measurement sketch needed. Height 1800 - 2200 mm. Shower tray installation measurement 750 - 1200 mm. Door max. 750 mm. One stabiliser included with widths 1000 mm and wider. <b>Surcharge for triangular and rectangular cut-outs as well as EXTRA WIDTHS up to 1800 mm.</b>							
<b>Swinging door attached on fixed part in alcove</b> 		<b>2000</b>	900	860 - 900	150 - 170	-	530
			1000	960 - 1000	180 - 200	-	580
			1200	1160 - 1200	230 - 250	-	680
<b>CUSTOM MEASUREMENTS</b> - Measurement sketch needed. Height 1500 - 2200 mm. Shower tray installation measurement 900 - 1400 mm. Door max. 750 mm. One stabiliser included with widths 1200 mm and wider. <b>Surcharge for triangular and rectangular cut-outs.</b>							
<b>Swinging door attached on fixed part in alcove extra wide</b> 		<b>2000</b>	1400	1360 - 1400	230 - 250 / 420 - 440	-	680
			1500	1460 - 1500	230 - 250 / 520 - 540	1	680
			1600	1560 - 1600	230 - 250 / 620 - 640	1	680
			1700	1660 - 1700	230 - 250 / 720 - 740	1	680
			1800	1760 - 1800	230 - 250 / 820 - 840	1	680
Stabiliser 1200 mm. Length must be adjusted on site. <b>CUSTOM MEASUREMENTS</b> - Measurement sketch needed. Height 1800 - 2200 mm. Shower tray installation measurement 1400 - 2000 mm. Door max. 750 mm. <b>Surcharge for triangular and rectangular cut-outs.</b>							
<b>Swinging door attached on fixed part in alcove</b> 		<b>2000</b>	1400	1360 - 1400	180 - 200	-	970
			1500	1460 - 1500	230 - 250	-	970
			1600	1560 - 1600	180 - 200	-	1170
			1700	1660 - 1700	230 - 250	-	1170
			1800	1760 - 1800	280 - 300	2	1170
<b>CUSTOM MEASUREMENTS</b> - Measurement sketch needed. Height 1800 - 2200 mm. Shower tray installation measurement 1200 - 2000 mm. Door max. 750 mm. <b>Surcharge for triangular and rectangular cut-outs as well as EXTRA WIDTHS up to 2500 mm.</b>							

Art. no.		Frame colour	Glazing	Glass finishing (optional)	Handle type	Colour	Handle/hinge
9 T							
Base price				Surcharge			
WM	left	right	MH High-gloss metal WS White . . Additional colours	EK Glass clear RW Strip Satin SA Satin	C ARTCLEAR GLAZING	K Knob R Horizontal H Vertical G Bow-type	. . same as frame <sup>1</sup> VC Chrome
750	9T5P1 39	9T5P2 39	1,387				
800	9T5P1 49	9T5P2 49	1,398	EK 0		K 0	
900	9T5P1 59	9T5P2 59	1,412	RW 259	211	R 0	. . 0
1000	9T5P1 69	9T5P2 69	1,448	SA 351		H 0	VC 0
	9T5P1 88	9T5P2 88	1,672			G 166	
			322				
900	9T4P1 59	9T4P2 59	1,566	EK 0		K 0	
1000	9T4P1 69	9T4P2 69	1,598	RW 259	211	R 0	. . 0
1200	9T4P1 B9	9T4P2 B9	1,724	SA 351		H 0	VC 0
	9T4P1 88	9T4P2 88	1,936			G 166	
			322				
1400	9T4P3 E9	9T4P4 E9	1,948				
1500	9T4P3 H9	9T4P4 H9	2,050	EK 0		K 0	
1600	9T4P3 K9	9T4P4 K9	2,239	RW 461	417	R 0	. . 0
1700	9T4P3 M9	9T4P4 M9	2,463	SA 692		H 0	VC 0
1800	9T4P3 P9	9T4P4 P9	2,517			G 166	
	9T4P3 88	9T4P4 88	2,690				
			322				
1400	9TDP0 E9						
1500	9TDP0 H9			EK 0		K 0	
1600	9TDP0 K9		2,294	RW 518	417	R 0	. . 0
1700	9TDP0 M9			SA 692		H 0	VC 0
1800	9TDP0 P9					G 331	
	9TDP0 88		2,821				
			322				

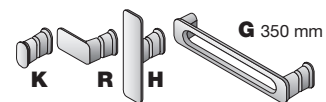

ARTWEGER 360  
partially framed

### IMPORTANT

- When ordering please indicate assembly on shower tray or flush with floor.
- <sup>1</sup> Only VC chrome-plated available with MH high-gloss metal frames.

# ARTWEGER 360 partially framed

Swinging door / Side screen  
6 mm ESG

ARTWEGER price list 03/2023. For specialised trade outlets only. Suggested retail prices in EUR not including VAT.  
DIMENSIONS IN MILLIMETRES.

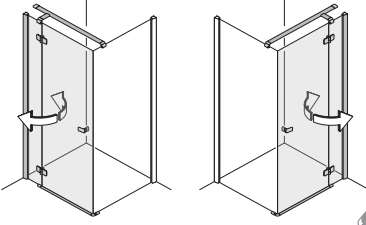
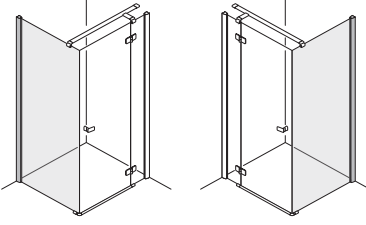
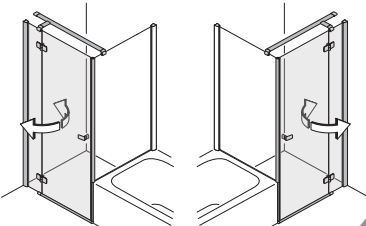
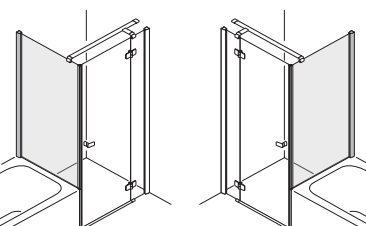
Hinge left	Hinge right	Height	Shower tray measurement (WM)	Shower tray installation measurement	Fixed part width Quantity stabilisers	Entrance width	
<b>Swinging door attached on fixed part next to side screen</b> 		<b>2000</b>	800	780 - 800	180 - 200	1	530
			900	880 - 900	180 - 200	1	630
			1000	980 - 1000	230 - 250	1	680
			1200	1180 - 1200	430 - 450	1	680
Hinge always on the wall side. Stabiliser 1200 mm. Length must be adjusted on site.							
<b>CUSTOM MEASUREMENTS</b> - Measurement sketch needed. Height 1800 - 2200 mm. Shower tray installation measurement 700 - 1300 mm. Door max. 750 mm. <b>Surcharge for triangular and rectangular cut-outs as well as EXTRA WIDTHS up to 1800 mm.</b>							
<b>Side screen next to swinging door</b> 		<b>2000</b>	800	780 - 800	-	-	-
			900	880 - 900	-	-	-
			1000	980 - 1000	-	-	-
<b>CUSTOM MEASUREMENTS</b> - Measurement sketch needed. Height 1800 - 2200 mm. Shower tray installation measurement 200 - 1200 mm. <b>Surcharge for triangular and rectangular cut-outs as well as EXTRA WIDTHS up to 1800 mm.</b>							
<b>Swinging door attached on fixed part next to shortened side screen</b> 		<b>2000</b>	800	780 - 800	150 - 170	1	580
			900	880 - 900	150 - 170	1	680
			1000	980 - 1000	250 - 270	1	680
Hinge always on the wall side. Stabiliser 1200 mm. Length must be adjusted on site.							
<b>CUSTOM MEASUREMENTS</b> - Measurement sketch needed. Height 1800 - 2200 mm. Shower tray installation measurement 700 - 1300 mm. Door max. 750 mm. <b>Surcharge for triangular and rectangular cut-outs as well as EXTRA WIDTHS up to 1800 mm.</b>							
<b>Shortened side screen</b> 		<b>CUSTOM MEASUREMENTS</b> - Measurement sketch needed. Fits winged door or swinging door. Height 1000 - 2200 mm. Shower tray installation measurement 200 - 1200 mm.			-	-	-
<b>Surcharge for triangular and rectangular cut-outs as well as EXTRA WIDTHS up to 1800 mm.</b>							

- Required installation height is total height + 100 mm.
- When ordering please indicate assembly on shower tray or flush with floor.

Art. no.		Frame colour	Glazing	Glass finishing (optional)	Handle type/ towel holder	Colour Handle/hinge/ towel holder	
9 T							
Base price			Surcharge				
WM	left	right	MH High-gloss metal WS White . . Additional colours	EK Glass clear RW Strip Satin SA Satin	C ARTCLEAR GLAZING	K Knob R Horizontal H Vertical G Bow-type T Towel holder	. . same as frame <sup>1</sup> VC Chrome
800	9T2P1 49	9T2P2 49	1,349	EK 0 RW 259 SA 351	211	K 0 R 0 H 0 G 166 T -	. . 0 VC 0
900	9T2P1 59	9T2P2 59					
1000	9T2P1 69	9T2P2 69					
1200	9T2P1 B9	9T2P2 B9					
	9T2P1 88	9T2P2 88	1,672				
			322				
800	9T1P1 49	9T1P2 49	882	EK 0 RW 204 SA 351	211	K - R - H - G - T 252	. . 0 VC 0
900	9T1P1 59	9T1P2 59					
1000	9T1P1 69	9T1P2 69					
	9T1P1 88	9T1P2 88	1,087				
			322				
800	9T3P1 49	9T3P2 49	1,412	EK 0 RW 259 SA 351	211	K 0 R 0 H 0 G 166 T -	. . 0 VC 0
900	9T3P1 59	9T3P2 59					
1000	9T3P1 69	9T3P2 69					
	9T3P1 88	9T3P2 88	1,672				
			322				
	9T601 88	9T602 88	989	EK 0 RW 204 SA 351	211	K - R - H - G - T 252	. . 0 VC 0
			322				

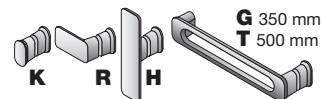

ARTWEGER 360  
partially framed

**IMPORTANT**

<sup>1</sup> Only VC chrome-plated available with MH high-gloss metal frames.

# ARTWEGER 360 partially framed

Swinging door / Side screen  
6 mm ESG

ARTWEGER price list 03/2023. For specialised trade outlets only. Suggested retail prices in EUR not including VAT.  
DIMENSIONS IN MILLIMETRES.

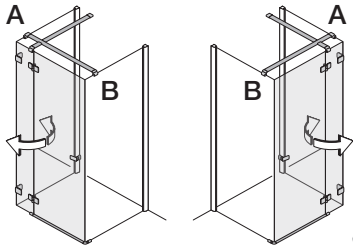
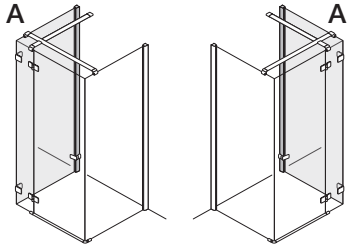
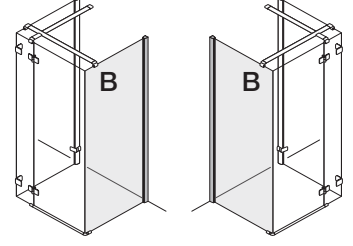
Hinge left	Hinge right	Height	Shower tray measurement (WM)	Shower tray installation measurement	Fixed part width Quantity stabilisers	Entrance width	
<b>Swinging door attached on fixed part for two side screens</b> 		2000	900	900	170	1	630
1 door part and 1 fixed part			1000	1000	220	1	680
Including stabiliser for side screens.							
<b>CUSTOM MEASUREMENTS - Measurement sketch needed.</b> Height 1800 - 2200 mm. Shower tray installation measurement 700 - 1400 mm. Door max. 750 mm.							
<b>Side screen A next to swinging door</b> 		2000	900	880 - 900	-	-	-
Side screen B next to swinging door			1000	980 - 1000	-	-	-
<b>CUSTOM MEASUREMENTS - Measurement sketch needed.</b> Height 1800 - 2200 mm. Shower tray installation measurement 700 - 1200 mm. <b>Surcharge for triangular and rectangular cut-outs.</b>							
		2000	900	880 - 900	-	-	-
			1000	980 - 1000	-	-	-
<b>CUSTOM MEASUREMENTS - Measurement sketch needed.</b> Height 1800 - 2200 mm. Shower tray installation measurement 700 - 1200 mm. <b>Surcharge for triangular and rectangular cut-outs.</b>							

## IMPORTANT

- Required installation height is total height + 100 mm.
- For installing on a straight piece of wall 2 side screens are necessary. (1 x left and 1 x right).

Art. no.		Frame colour	Glazing	Glass finishing (optional)	Handle type/ towel holder	Colour Handle/hinge/ towel holder	
9 T							
Base price			Surcharge				
WM	left	right	MH High-gloss metal WS White . . Additional colours	EK Glass clear RW Strip Satin SA Satin	C ARTCLEAR GLAZING	K Knob R Horizontal H Vertical G Bow-type T Towel holder	. . same as frame <sup>1</sup> VC Chrome
900	9TGP1 59	9TGP2 59	1,349	EK 0	211	K 0 R 0 H 0	. . 0
1000	9TGP1 69	9TGP2 69	1,421	RW 259 SA 351		G 166 T -	VC 0
	9TGP1 88	9TGP2 88	1,672				
900	9TH01 59	9TH02 59	882	EK 0	211	K - R - H -	. . 0
1000	9TH01 69	9TH02 69	932	RW 204 SA 351		G - T 252	VC 0
	9TH01 88	9TH02 88	1,087				
			322				
900	9T1P2 59	9T1P1 59	882	EK 0	211	K - R - H -	. . 0
1000	9T1P2 69	9T1P1 69	932	RW 204 SA 351		G - T 252	VC 0
	9T1P2 88	9T1P1 88	1,087				
			322				

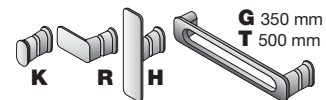

ARTWEGER 360  
partially framed

## IMPORTANT

- When ordering please indicate assembly on shower tray or flush with floor.
- <sup>1</sup> Only VC chrome-plated available with MH high-gloss metal frames.

# ARTWEGER 360 partially framed

Swinging door 6 mm ESG

ARTWEGER price list 03/2023. For specialised trade outlets only. Suggested retail prices in EUR not including VAT.  
DIMENSIONS IN MILLIMETRES.

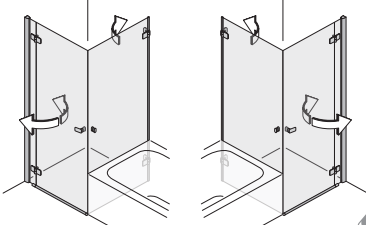
Hinge left	Hinge right	Height	Shower tray measurement (WM)	Shower tray installation measurement	Fixed part width	Entrance width		
<b>Swinging door attached on fixed part with swinging side screen next to bathtub</b> 		<b>2000</b>	800 × 800	780 - 800 × 800	140 - 160	580		
			left	900 × 900	right	880 - 900 × 900	140 - 160	680
				900 × 750		880 - 900 × 750	140 - 160	680
				Door at 900		880 - 900 × 800	140 - 160	680
				Door at 900		880 - 900 × 800	140 - 160	680

In general a scale drawing is required for a swinging side element.

**CUSTOM MEASUREMENTS - Measurement sketch needed.**

Height 1800 - 2200 mm. Shower tray installation measurement: door up to 1200 mm, side screen up to 900 mm.

Price for combination of custom and standard measurement: (custom price + standard price) / 2.

1 door part and 1 fixed part

**Swinging door attached on fixed part with swinging side screen next to bathtub**

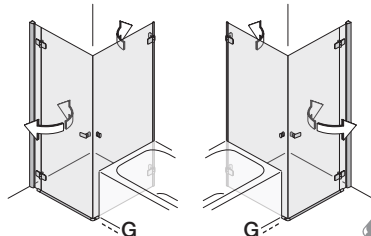

1 door part and 1 fixed part

<b>2000</b>	800 × 800	780 - 800 × 800	140 - 160	580		
	left	900 × 900	right	880 - 900 × 900	140 - 160	680
		900 × 750		880 - 900 × 750	140 - 160	680
		Door at 900		880 - 900 × 800	140 - 160	680
		Door at 900		880 - 900 × 800	140 - 160	680

**Shower tray and bathtub not flush.**

In general a scale drawing is required for a swinging side element.

**CUSTOM MEASUREMENTS - Measurement sketch needed.**

Height 1800 - 2200 mm. Shower tray installation measurement: door up to 1200 mm, side screen up to 900 mm.

Price for combination of custom and standard measurement: (custom price + standard price) / 2.

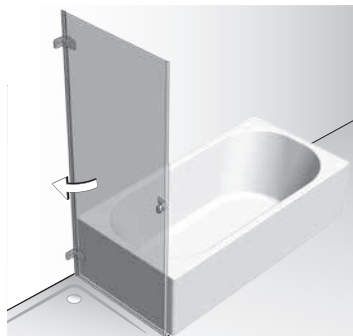

Detail of the swinging side screen when adjoined to the bathtub.

**IMPORTANT**

- Required installation height is total height + 30 mm.
- When ordering please indicate assembly on shower tray or flush with floor.



Art. no.		Frame colour	Glazing	Glass finishing (optional)	Handle type	Colour Handle/hinge	
9 T							
Base price			Surcharge				
WM	left	right	MH High-gloss metal WS White . . Additional colours	EK Glass clear RW Strip Satin SA Satin	C ARTCLEAR GLAZING	K Knob R Horizontal H Vertical G Bow-type	. . same as frame <sup>1</sup> VC Chrome
800	9TAP1 49	9TAP2 49	2,382	EK 0 RW 518 SA -	417	K 0 R 0 H 0 G 166	. . 0 VC 0
900	9TAP1 59	9TAP2 59					
900/750	9TAP1 C9	9TAP2 C9					
900/800	9TAP1 D9	9TAP2 D9					
	9TAP1 88	9TAP2 88	2,937				
800	9TBP1 49	9TBP2 49	2,382	EK 0 RW 518 SA -	417	K 0 R 0 H 0 G 166	. . 0 VC 0
900	9TBP1 59	9TBP2 59					
900/750	9TBP1 C9	9TBP2 C9					
900/800	9TBP1 D9	9TBP2 D9					
	9TBP1 88	9TBP2 88	2,937				

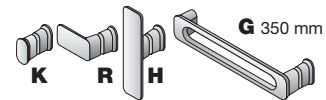

ARTWEGER 360  
partially framed

### IMPORTANT

<sup>1</sup> Only VC chrome-plated available with MH high-gloss metal frames.

# ARTWEGER 360 Folding doors

Fold-away shower.

- Folding doors with or without fixed parts
- Folding doors with fixed part: Wall profile with 3D adjustment and concealed silicone joint, 360° TWIN hinge
- Folding doors without fixed part: 180° rotating-cylinder wall connector, 360° TWIN hinge between the door parts
- Barrier-free
- Raise and lower mechanism
- Certified adhesion technique
- 6 mm single-pane safety glass
- Standard height 2000 mm
- Adjustment range 18 mm without fixed part or 20 mm with fixed part
- Custom sizes available



Especially EASY TO CLEAN.



SWINGING DOORS: The doors can be opened up to 180° inwards and outwards.



100 % FLUSH-TO-FLOOR ACCESS



Artweger®

artclear  
GLASS



Knob K

IMPORTANT

# ACCESSORIES

ARTWEGER price list 03/2023. For specialised trade outlets only.  
Suggested retail prices in EUR not including VAT. DIMENSIONS IN MILLIMETRES.

Art. no. Colour

9	0						
---	---	--	--	--	--	--	--

Base price

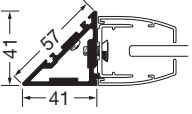
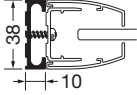
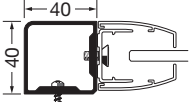
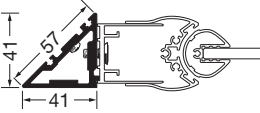
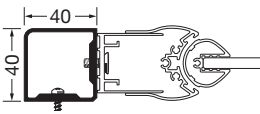
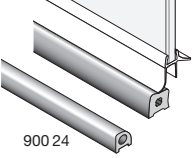
	Height	Art. no.	MH High-gloss metal WS White . . . Additional colours
 <p><b>Mounting bracket, 45°</b> For installation on tiled walls under 45°. Necessary additional information: article number of the respective shower enclosure.</p>	2000	<b>90P 79</b>	259
	Custom size	<b>90P 78</b>	310
 <p><b>Compound bracket 10 mm</b> Extends adjustment range of all products with fixed part by 10 mm. Necessary additional information: article number of the respective shower enclosure.</p>	2000	<b>90P 39</b>	162
	Custom size	<b>90P 38</b>	194
 <p><b>Mounting bracket</b> For attaching to wall projections. Necessary additional information: article number of the respective shower enclosure.</p>	2000	<b>90P 19</b>	259
	Custom size	<b>90P 18</b>	310
 <p><b>Mounting bracket, 45° for folding doors without fixed part</b> For installation on tiled walls under 45°. Necessary additional information: article number of the respective shower enclosure.</p>	2000	<b>90P 99</b>	259
	Custom size	<b>90P 98</b>	310
 <p><b>Mounting bracket for folding doors without fixed part</b> For attaching to wall projections. Necessary additional information: article number of the respective shower enclosure.</p>	2000	<b>90P 29</b>	259
	Custom size	<b>90P 28</b>	310
 <p><b>Overflow moulding</b> To enhance watertightness in the entrance area. Corner entry with folding doors attached on fixed part Double folding door attached on fixed part Quadruple folding door attached on fixed part Corner entry with folding doors without fixed parts</p>	12	<b>900 21</b>	169
	12	<b>900 22</b>	115
	12	<b>900 23</b>	160
	10	<b>900 24</b>	169

ARTWEGER 360  
partially framed

## FOLDING DIRECTION OF ARTWEGER 360 FOLDING DOORS.

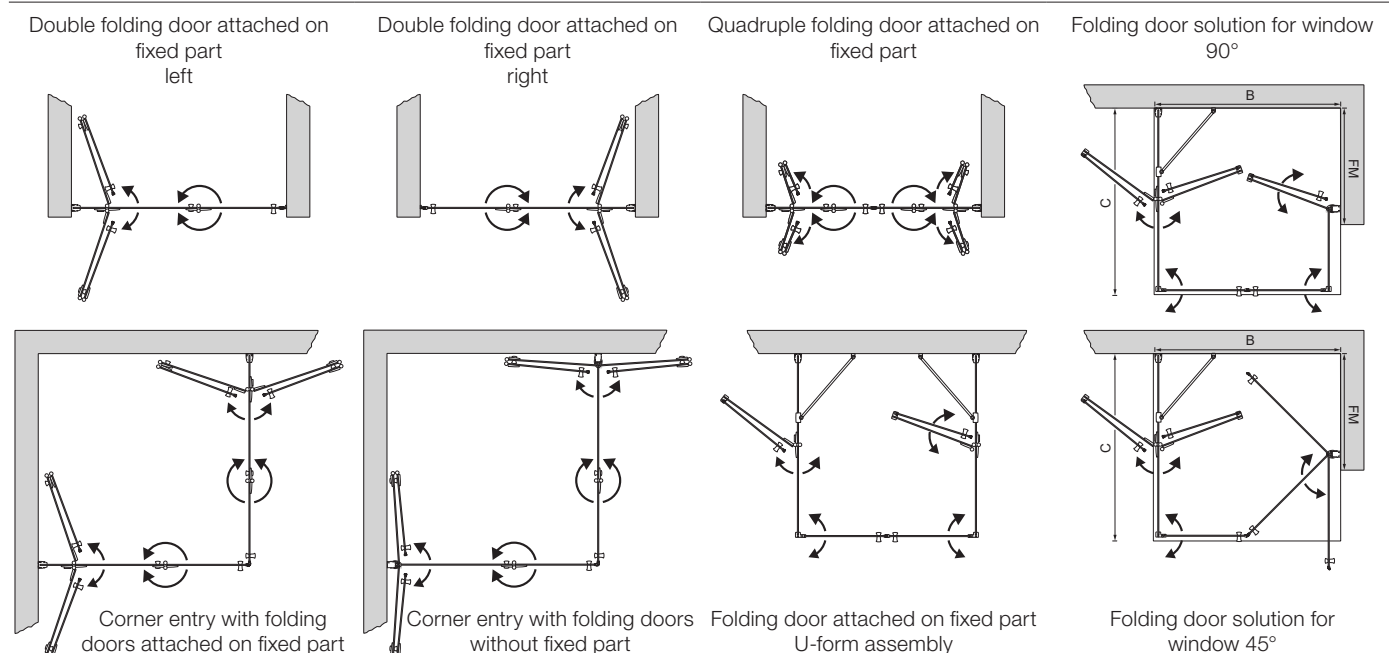

### IMPORTANT

- We will gladly send you the documents in hard copy on request.

# ARTWEGER 360 partially framed

Folding door / Side screen 6 mm ESG

ARTWEGER price list 03/2023. For specialised trade outlets only. Suggested retail prices in EUR not including VAT.  
DIMENSIONS IN MILLIMETRES.

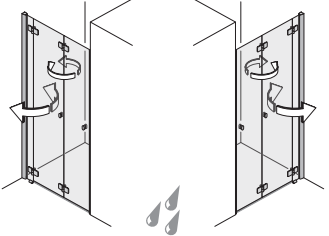
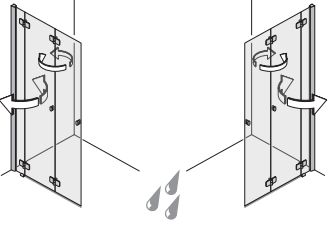
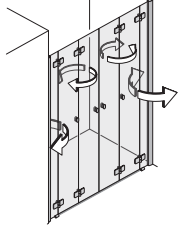
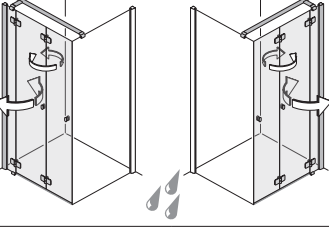
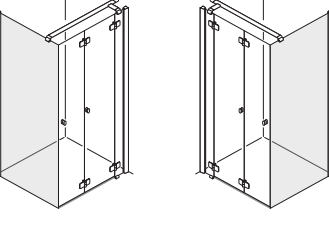
Hinge left	Hinge right	Height	Shower tray measurement (WM)	Shower tray installation measurement	Fixed part width Quantity stabilisers	Entrance width
<b>Double folding door attached on fixed part in alcove</b> 		<b>2000</b>	750	730 - 750	150 - 170 -	560
			800	780 - 800	150 - 170 -	610
			900	880 - 900	150 - 170 -	710
			1000	980 - 1000	150 - 170 -	810
			1200	1180 - 1200	200 - 220 -	960
<b>CUSTOM MEASUREMENTS</b> - Measurement sketch needed. Height 1800 - 2200 mm. Width 750 - 1800 mm. Folding doors max. 950 mm. One stabiliser included with fixed part widths 250 mm and wider.						
<b>Double folding door attached on fixed part free-standing</b> 		<b>2000</b>	1000	980 - 1000	180 - 200 -	800
			1200	1180 - 1200	230 - 250 -	950
			1400	1380 - 1400	430 - 450 1	950
<b>CUSTOM MEASUREMENTS</b> - Measurement sketch needed. Height 1800 - 2200 mm. Width 750 - 1800 mm. Folding doors max. 950 mm. One stabiliser included with fixed part widths 250 mm and wider.						
<b>Quadruple folding door attached on fixed part in alcove</b> 		<b>2000</b>	1500	1460 - 1500	170 - 190 -	1060
			1600	1560 - 1600	170 - 190 -	1130
			1700	1660 - 1700	170 - 190 -	1260
			1800	1760 - 1800	170 - 190 -	1330
			1900	1860 - 1900	170 - 190 -	1460
			2000	1960 - 2000	170 - 190 -	1530
<b>CUSTOM MEASUREMENTS</b> - Measurement sketch needed. Height 1800 - 2200 mm. Width 1500 - 2500 mm. Folding doors max. 1900 mm. One stabiliser included with fixed part widths 250 mm and wider.						
<b>Double folding door attached on fixed part next to side screen</b> 		<b>2000</b>	800	780 - 800	180 - 200 1	550
			900	880 - 900	180 - 200 1	650
			1000	980 - 1000	180 - 200 1	750
			1200	1180 - 1200	180 - 200 1	950
Hinge always on the wall side. Stabiliser 1200 mm. Length must be adjusted on site. <b>CUSTOM MEASUREMENTS</b> - Measurement sketch needed. Height 1800 - 2200 mm. Width up to 1800 mm. Folding doors max. 950 mm.						
<b>Side screen next to double folding door</b> 		<b>2000</b>	800	780 - 800	- -	-
			900	880 - 900	- -	-
			1000	980 - 1000	- -	-
<b>CUSTOM MEASUREMENTS</b> - Measurement sketch needed. Height 1800 - 2200 mm. Shower tray installation measurement 200 - 1200 mm. <b>Surcharge for triangular and rectangular cut-outs as well as EXTRA WIDTHS up to 1800 mm.</b>						

## IMPORTANT

- Height + 30 mm = total height incl. stabiliser. Required installation height is total height + 100 mm.
- Dimensions including dimension sketch required.

Art. no.		Frame colour	Glazing	Glass finishing (optional)	Handle type/ towel holder	Colour Handle/hinge/ towel holder	
9 T							
Base price			Surcharge				
WM	left	right	MH High-gloss metal WS White/chrome . . Additional colours	EK Glass clear RW Strip Satin	C ARTCLEAR GLAZING	K Knob T Towel holder	. . same as frame <sup>1</sup> VC Chrome
750	9T5T1 39	9T5T2 39	1,793	EK 0 RW 351	211	K 0 T -	. . 0 VC 0
800	9T5T1 49	9T5T2 49					
900	9T5T1 59	9T5T2 59					
1000	9T5T1 69	9T5T2 69					
1200	9T5T1 B9	9T5T2 B9					
	9T5T1 88	9T5T2 88	2,035				
1000	9TWT1 69	9TWT2 69	1,793	EK 0 RW 461	211	K 0 T -	. . 0 VC 0
1200	9TWT1 B9	9TWT2 B9					
1400	9TWT1 E9	9TWT2 E9					
	9TWT1 88	9TWT2 88					
1500	9TDT0 H9		3,252	EK 0 RW 518	417	K 0 T -	. . 0 VC 0
1600	9TDT0 K9						
1700	9TDT0 M9						
1800	9TDT0 P9						
1900	9TDT0 S9						
2000	9TDT0 U9						
	9TDT0 88		3,664				
800	9T2T1 49	9T2T2 49	2,061	EK 0 RW 351	211	K 0 T -	. . 0 VC 0
900	9T2T1 59	9T2T2 59					
1000	9T2T1 69	9T2T2 69					
1200	9T2T1 B9	9T2T2 B9					
	9T2T1 88	9T2T2 88					
			2,329				
800	9T1P1 49	9T1P2 49	882	EK 0 RW 204	211	K - T 252	. . 0 VC 0
900	9T1P1 59	9T1P2 59					
1000	9T1P1 69	9T1P2 69					
	9T1P1 88	9T1P2 88	1,087				
			322				

ARTWEGER 360  
partially framed

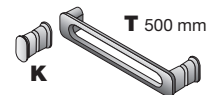

### IMPORTANT







- Execution without overflow moulding. Where the downward incline is insufficient or when mounting on a shower tray, a splash water bar is required for adequate protection. See page 37.

<sup>1</sup> Only VC chrome-plated available with MH high-gloss metal frames.

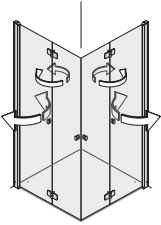
# ARTWEGER 360 partially framed

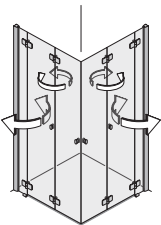
Folding door 6 mm ESG

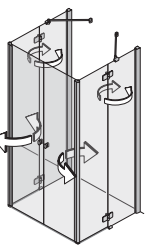
ARTWEGER price list 03/2023. For specialised trade outlets only. Suggested retail prices in EUR not including VAT.  
DIMENSIONS IN MILLIMETRES.

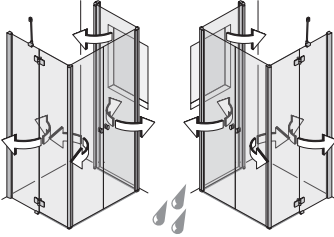
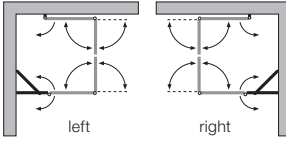
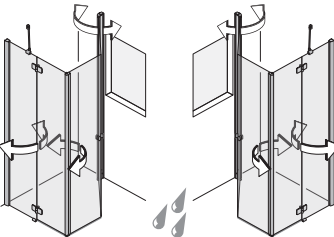
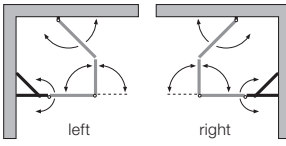
left	right	Height	Shower tray measurement (WM)	Shower tray installation measurement	Fixed part width Quantity stabilisers	Entrance width
<b>Corner entry with folding doors without fixed parts</b> 		<b>2000</b>	800 × 800	782 - 800 × 782 - 800	- -	960
			900 × 900	882 - 900 × 882 - 900	- -	1100
			1000 × 1000	982 - 1000 × 982 - 1000	- -	1240
			1200 × 1200	1182 - 1200 × 1182 - 1200	- -	1520
 <b>CUSTOM MEASUREMENTS</b> - Measurement sketch needed. Height 1800 - 2000 mm. Width up to 1200 × 1200 mm.						
<b>Corner entry with folding doors attached on fixed part</b> 		<b>2000</b>	800 × 800	780 - 800 × 780 - 800	180 - 200 -	790
			900 × 900	880 - 900 × 880 - 900	180 - 200 -	930
			1000 × 1000	980 - 1000 × 980 - 1000	180 - 200 -	1070
			1200 × 1200	1180 - 1200 × 1180 - 1200	180 - 200 -	1360
 <b>CUSTOM MEASUREMENTS</b> - Measurement sketch needed. Height 1800 - 2200 mm. Width up to 1600 × 1600 mm. One stabiliser included with fixed part widths 250 mm and wider.						
<b>Folding door attached on fixed part U-form assembly</b> 		<b>2000</b>	1000 × 1000	Installation on straight wall. Optional overflow molding not available.	custom size 2	custom size
 <b>CUSTOM MEASUREMENTS</b> - Measurement sketch needed. Height 1910 - 2000 mm. Width up to 1000 × 1000 mm.						
<b>Folding door solution for window 90°</b> 		<b>CUSTOM MEASUREMENTS</b> - Measurement sketch needed. Height 1800 - 2000 mm. Width up to 1000 × 1000 mm. Optional overflow molding not available.			custom size 1	custom size
						
<b>Folding door solution for window 45°</b> 		<b>CUSTOM MEASUREMENTS</b> - Measurement sketch needed. Height 1800 - 2000 mm. Width up to 1000 × 1000 mm. Optional overflow molding not available.			custom size 1	custom size
						

## IMPORTANT

- Corner entry without fixed parts, folding door solution for window: Required installation height is total height + 250 mm.
- Corner entry attached on fixed part: Required installation height is total height + 30 mm.
- Folding door U-form assembly: Required installation height is total height + 100 mm.
- Dimensions including dimension sketch required.

Art. no.		Frame colour	Glazing	Glass finishing (optional)	Handle type	Colour	Handle/hinge
9 T							
Base price				Surcharge			
WM	left	right	MH High-gloss metal WS White/chrome . . Additional colours	EK Glass clear RW Strip Satin	C ARTCLEAR GLAZING	K Knob	. . same as frame <sup>1</sup> VC Chrome
800	<div style="border: 1px solid black; border-radius: 10px; padding: 5px; display: inline-block;"> <b>9TETW 49</b>  <b>9TETW 59</b>  <b>9TETW 69</b> </div>		2,908  3,035	<b>EK</b> 0 <b>RW</b> 518	417	0	. . 0 <b>VC</b> 0
900							
1000							
1200							
	<b>9TETW 88</b>		3,346				
800	<div style="border: 1px solid black; border-radius: 10px; padding: 5px; display: inline-block;"> <b>9TETO 49</b>  <b>9TETO 59</b>  <b>9TETO 69</b> </div>		3,183  3,321	<b>EK</b> 0 <b>RW</b> 518	417	0	. . 0 <b>VC</b> 0
900							
1000							
1200							
	<b>9TETO 88</b>		3,664				
up to 1000	<b>9TVP0 69</b>		4,118	<b>EK</b> 0 <b>RW</b> 692	417	0	. . 0 <b>VC</b> 0
	<b>9TVP0 88</b>		4,531				
up to 1000	<b>9TL21 88</b>	<b>9TL22 88</b>	4,118	<b>EK</b> 0 <b>RW</b> 692	417	0	. . 0 <b>VC</b> 0
up to 1000	<b>9TL11 88</b>	<b>9TL12 88</b>	3,929	<b>EK</b> 0 <b>RW</b> 692	417	0	. . 0 <b>VC</b> 0

 ARTWEGER 360  
partially framed

### IMPORTANT

- Execution without overflow moulding. Where the downward incline is insufficient or when mounting on a shower tray, a splash water bar is required for adequate protection. See page 37.

<sup>1</sup> Only VC chrome-plated available with MH high-gloss metal frames.

# ARTWEGER 360 frameless

Unique design.

- Winged doors and swinging doors with or without fixed doors
- Swinging doors with 360° TWIN hinge
- Barrier-free with Vario sealing system
- Raise and lower mechanism
- Optional wall bracket inwards or outwards
- Certified adhesion technique
- 6 mm single-pane safety glass
- Standard height 2000 mm
- Customized solutions
- Custom sizes available

## HANDLE TYPES

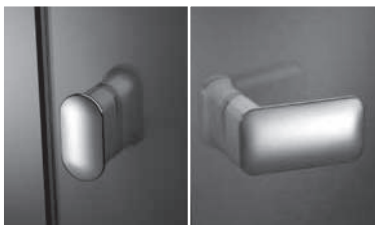

Knob **K**

Horizontal **R**

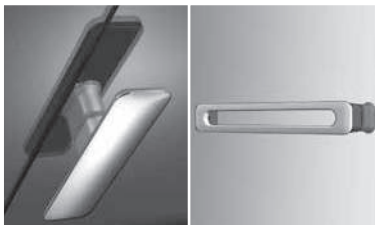

Vertical **H**

Bow-type **G**



The transparent glass elements reach to the wall. Narrow brackets provide strong and safe stability.



WINGED DOOR: Especially EASY TO CLEAN.



Artweger®

artclear  
GLASS

CE

according to EN 14428



SWINGING DOOR: The doors can be opened up to 180° inwards and outwards.

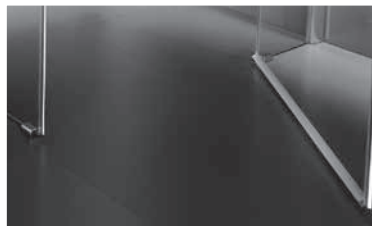

VARIO sealing system:  
You decide either for 100 %  
FLUSH-TO-FLOOR ACCESS or ...

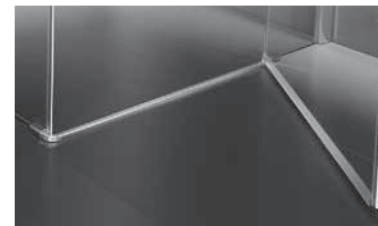

... for an optional surge bar which  
is only 12 mm high and provides  
IMPROVED SEALING of the door.



# ACCESSORIES

ARTWEGER price list 03/2023. For specialised trade outlets only.  
Suggested retail prices in EUR not including VAT. DIMENSIONS IN MILLIMETRES.

Art. no.	Colour
9 0	
	Base price

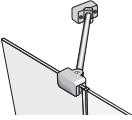
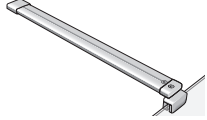
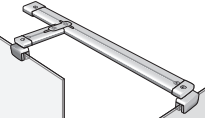
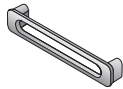
	Length	Art. no.	MH High-gloss metal WS White . . . Additional colours
 <b>Stabiliser</b> Fits quarter-round and pentagonal shower, doors and corner entry.	ca. 300	<b>900 41</b>	158
	ca. 430	<b>900 42</b>	172
 <b>Side-screen stabiliser</b> Length has to be adjusted on site.	ca. 1200	<b>900 44</b>	183
 <b>T-Stabilizer</b> Length has to be adjusted on site.	ca. 1200	<b>900 46</b>	247
	Width	Art. no.	VC Chrome WS White . . . Additional colours
 <b>Towel holder</b> For installation on tiled walls.	550	<b>900 11</b>	252

ARTWEGER 360  
frameless

## EQUIPMENT OF THE ARTWEGER 360 FRAMELESS

### Attachment to the wall Standard

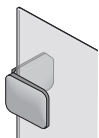

Brackets inwards.  
Attachment to wall is on the interior of the shower.

### Attachment to the wall optional

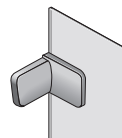

Brackets outwards.  
Wall bracket on the outside of the shower. Not possible for doors without an anchored wall and swivelling side wall.

## LEFT/RIGHT in the case of an asymmetric shower tray

LEFT

**9RRF1 A9**  
**9RRF1 C9**  
**9RRP1 A9**  
**9RRP1 C9**

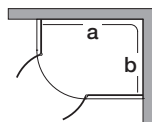
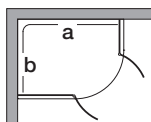

RIGHT

**9RRF2 A9**  
**9RRF2 C9**  
**9RRP2 A9**  
**9RRP2 C9**

LEFT

**9R8F1 B9**  
**9R8F1 D9**

Door on wide fixed part

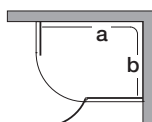
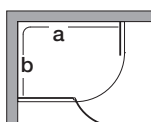

RIGHT

**9R8F2 B9**  
**9R8F2 D9**

Door on wide fixed part

LEFT

**9R8F1 S9**  
**9R8F1 T9**

Door on narrow fixed part

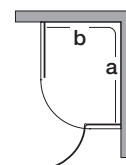
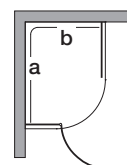

RIGHT

**9R8F2 S9**  
**9R8F2 T9**

Door on narrow fixed part

## IMPORTANT

- We will gladly send you the documents in hard copy on request.

# ARTWEGER 360 frameless

Winged door 6 mm ESG

ARTWEGER price list 03/2023. For specialised trade outlets only. Suggested retail prices in EUR not including VAT.  
DIMENSIONS IN MILLIMETRES.

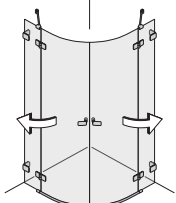
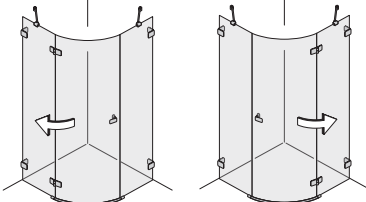
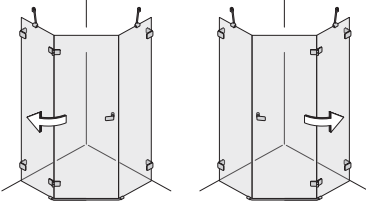
Hinge left	Hinge right	Height	Shower tray measurement (WM) length a x width b	Overview of product features	Quantity stabilisers	Entrance width			
<b>1/4-round shower</b> 		<b>2000</b>	800 x 800 I R=500 900 x 900 I R=500 900 x 900 II R=550 1000 x 1000 II R=550 900 x 800 I R=500 1000 x 900 II R=550	<ul style="list-style-type: none"> <li>According to dimension sketch.</li> </ul>	- 2 - 2 1 1	850 850 990 990 850 990			
2 winged doors and 2 fixed parts			<b>CUSTOM MEASUREMENTS</b> - Measurement sketch needed. fixed-part custom width (narrower or wider). Width max. 1200 x 1200 mm. Custom heights not available. <b>Surcharge for triangular and rectangular cut-outs.</b>						
<b>1/4-round shower</b> 			<b>2000</b>	800 x 800 I R=500 900 x 900 I R=500 900 x 900 II R=550 1000 x 1000 I R=500 1000 x 1000 II R=550 900 x 800 I R=500 Door on wide fixed part 900 x 800 I R=500 Door on narrow fixed part 1000 x 900 II R=550 Door on wide fixed part 1000 x 900 II R=550 Door on narrow fixed part	<ul style="list-style-type: none"> <li>According to dimension sketch.</li> </ul>	1 2 2 2 2 1 2 2 2	600 600 650 650 650 600 600 650 650		
1 winged door and 2 fixed parts				<b>CUSTOM MEASUREMENTS</b> - Measurement sketch needed. fixed-part custom width (narrower or wider). Width max. 1200 x 1200 mm. Custom heights not available. <b>Surcharge for triangular and rectangular cut-outs.</b>					
<b>Pentagonal shower</b> 				<b>2000</b>	900 x 900 I M=707 900 x 900 IV M=636 1000 x 1000 I M=707 1000 x 1000 IV M=636	<ul style="list-style-type: none"> <li>According to dimension sketch.</li> </ul>	2 2 2 2	660 590 660 590	
1 winged door and 2 fixed parts					<b>CUSTOM MEASUREMENTS</b> - Measurement sketch needed. Height 1500 - 2200 mm. fixed-part custom width (narrower or wider). <b>Surcharge for triangular and rectangular cut-outs.</b>				

## IMPORTANT

- With stabiliser: required installation height ist total height + 100 mm.  
Without stabiliser: required installation height is total height + 30 mm.
- ARTWEGER 360 FRAMELESS is individually custom adapted to the exact installation situation. Production can only take place upon presentation of an exact dimension sketch.

Art. no.		Colour	Glazing	Glass finishing (optional)	Handle type	Brackets	
9 R							
Base price			Surcharge				
WM	left	right	VC Chrome WS White . . Additional colours	EK Glass clear RW Strip Satin SA Satin	C ARTCLEAR GLAZING	K Knob R Horizontal H Vertical G Bow-type	I inwards A outwards
800I	9RRF0 49		2,911				
900I	9RRF0 19		2,962	EK 0 RW - SA -	417	K 0 R 0 H 0 G -	I 0 A 0
900II	9RRF0 29						
1000II	9RRF0 69		3,118				
900/800I	9RRF1 A9	9RRF2 A9	2,962				
1000/900II	9RRF1 C9	9RRF2 C9	3,118				
	9RRF0 88		3,424				
			275				
800I	9R8F1 49	9R8F2 49	2,911				
900I	9R8F1 19	9R8F2 19	2,962	EK 0 RW - SA -	417	K 0 R 0 H 0 G -	I 0 A 0
900II	9R8F1 29	9R8F2 29					
1000I	9R8F1 E9	9R8F2 E9	3,118	EK 0 RW - SA -	417	K 0 R 0 H 0 G -	I 0 A 0
1000II	9R8F1 69	9R8F2 69					
900/800I	9R8F1 B9	9R8F2 B9	2,962				
900x800I	9R8F1 S9	9R8F2 S9					
1000/900II	9R8F1 D9	9R8F2 D9	3,118	EK 0 RW - SA -	417	K 0 R 0 H 0 G -	I 0 A 0
1000/900II	9R8F1 T9	9R8F2 T9					
	9R8F1 88	9R8F2 88	3,424				
			275				
900I	9R7F1 59	9R7F2 59	2,743	EK 0 RW 390 SA 677	417	K 0 R 0 H 0 G 166	I 0 A 0
900IV	9R7F1 39	9R7F2 39					
1000I	9R7F1 69	9R7F2 69	2,867	EK 0 RW 390 SA 677	417	K 0 R 0 H 0 G 166	I 0 A 0
1000IV	9R7F1 99	9R7F2 99					
	9R7F1 88	9R7F2 88	3,157				
			275				

ARTWEGER 360  
frameless

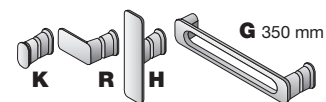

### IMPORTANT

- When ordering please indicate assembly on shower tray or flush with floor.
- The manufacture of individually curved glass is not possible. Dimension tolerances to the tiled shower area are possible for technical reasons.
- Correct installation is only possible if the floor is horizontal and the walls are vertical.

# ARTWEGER 360 frameless

Winged door 6 mm ESG

ARTWEGER price list 03/2023. For specialised trade outlets only. Suggested retail prices in EUR not including VAT.  
DIMENSIONS IN MILLIMETRES.

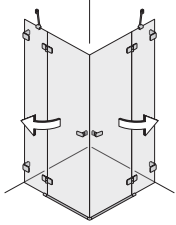
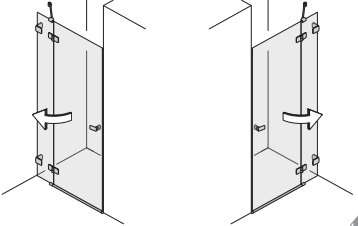
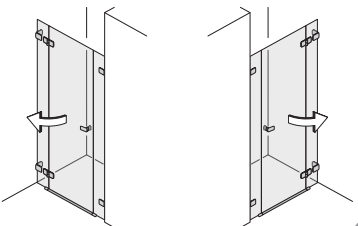
Hinge left	Hinge right	Height	Shower tray measurement (WM)	Overview of product features	Quantity stabilisers depending on fixed part width	Entrance width
<b>Corner entry</b>  2 winged doors and 2 fixed parts		2000	up to 1000 x 1000	<ul style="list-style-type: none"> <li>According to dimension sketch.</li> </ul>	0-2	up to 840
<p><b>CUSTOM MEASUREMENTS</b> - Measurement sketch needed.                      Height 1500 - 2200 mm. Width up to 1200 x 1200 mm. Door max. 750 mm.                      Price for combination of custom and standard measurement:                      (custom price + standard price) / 2.  <b>Surcharge for triangular and rectangular cut-outs as well as EXTRA WIDTHS up to 1600 x 1600 mm.</b></p>						
<b>Winged door attached on fixed part in alcove</b>  1 door part and 1 fixed part		2000	up to 1000	<ul style="list-style-type: none"> <li>According to dimension sketch.</li> </ul>	0-1	up to 680
<p><b>CUSTOM MEASUREMENTS</b> - Measurement sketch needed.                      Height 1500 - 2200 mm. Width up to 1200 mm.                      Door max. 750 mm. One stabiliser included with custom widths 910 mm and wider.  <b>Surcharge for triangular and rectangular cut-outs as well as EXTRA WIDTHS up to 1800 mm.</b></p>						
<b>Winged door attached on fixed part in alcove</b>  1 door part and 2 fixed parts		2000	up to 1000 up to 1400	<ul style="list-style-type: none"> <li>According to dimension sketch.</li> </ul>	- 0-2	up to 630 up to 680
<p><b>CUSTOM MEASUREMENTS</b> - Measurement sketch needed.                      Height 1500 - 2200 mm. Width up to 1600 mm.                      Door max. 750 mm. Stabiliser included with widths 1020 mm and wider.                      Two stabilisers included with widths 1410 mm and wider.  <b>Surcharge for triangular and rectangular cut-outs as well as EXTRA WIDTHS up to 2000 mm.</b></p>						

## IMPORTANT

- With stabiliser: required installation height ist total height + 100 mm.  
Without stabiliser: required installation height is total height + 30 mm.
- Correct installation is only possible if the floor is horizontal and the walls are vertical.

Art.no.		Colour	Glazing	Glass finishing (optional)	Handle type	Brackets	
9 R							
Base price			Surcharge				
WM	left	right	VC Chrome WS White . . Additional colours	EK Glass clear RW Strip Satin SA Satin	C ARTCLEAR GLAZING	K Knob R Horizontal H Vertical G Bow-type	I inwards A outwards
up to 1000	9REF069		2,743	EK 0 RW 518 SA 692	417	K 0 R 0 H 0 G 331	I 0 A 0
	9REF088		3,118				
			275				
up to 1000	9R5F1 69	9R5F2 69	1,698	EK 0 RW 259 SA 351	211	K 0 R 0 H 0 G 166	I 0 A 0
	9R5F1 88	9R5F2 88	1,966				
			275				
up to 1000	9R4F1 69	9R4F2 69	1,899	EK 0 RW 259 SA 351	211	K 0 R 0 H 0 G 166	I 0 A 0
up to 1400	9R4F1 E9	9R4F2 E9	2,040				
	9R4F1 88	9R4F2 88	2,305				
			275				

ARTWEGER 360  
frameless

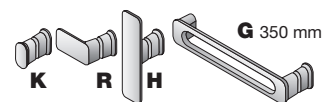

### IMPORTANT

- ARTWEGER 360 FRAMELESS is individually custom adapted to the exact installation situation. Production can only take place upon presentation of an exact dimension sketch.
- When ordering please indicate assembly on shower tray or flush with floor.

# ARTWEGER 360 frameless

Winged door / Side screen 6 mm ESG

ARTWEGER price list 03/2023. For specialised trade outlets only. Suggested retail prices in EUR not including VAT.  
DIMENSIONS IN MILLIMETRES.

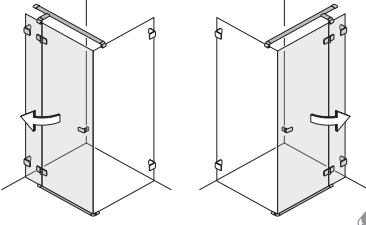
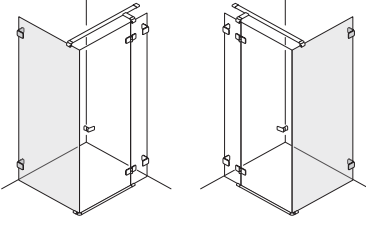
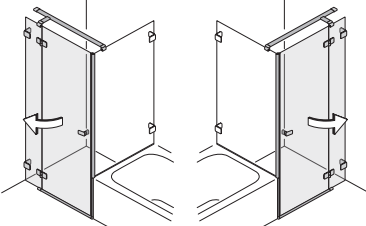
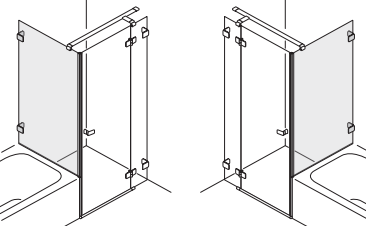
Hinge left	Hinge right	Height	Shower tray measurement (WM)	Overview of product features	Quantity stabilisers	Entrance width	
<b>Winged door attached on fixed part next to side screen</b> 		<b>2000</b>	up to 1000 up to 1200	<ul style="list-style-type: none"> <li>• Hinge always on the wall side.</li> <li>• According to dimension sketch.</li> <li>• Stabiliser 1200 mm. Length must be adjusted on site.</li> </ul>	1  1	up to 680  680	
1 door part and 1 fixed part							
<b>CUSTOM MEASUREMENTS - Measurement sketch needed.</b> Height 1500 - 2200 mm. Width up to 1300 mm. Door max. 750 mm.							
<b>Surcharge for triangular and rectangular cut-outs as well as EXTRA WIDTHS up to 1800 mm.</b>							
<b>Side screen next to winged door</b> 		<b>2000</b>	up to 1000	<ul style="list-style-type: none"> <li>• According to dimension sketch.</li> </ul>	-	-	
1 door part and 1 fixed part							
<b>CUSTOM MEASUREMENTS - Measurement sketch needed.</b> Height 1500 - 2200 mm. Width up to 1200 mm.							
<b>Surcharge for triangular and rectangular cut-outs as well as EXTRA WIDTHS up to 1800 mm.</b>							
<b>Winged door attached on fixed part next to shortened side screen</b> 		<b>2000</b>	up to 1000	<ul style="list-style-type: none"> <li>• Hinge always on the wall side.</li> <li>• According to dimension sketch.</li> <li>• Stabiliser 1200 mm. Length must be adjusted on site.</li> </ul>	1	up to 680	
1 door part and 1 fixed part							
<b>CUSTOM MEASUREMENTS - Measurement sketch needed.</b> Height 1500 - 2200 mm. Width up to 1300 mm. Door max. 750 mm.							
<b>Surcharge for triangular and rectangular cut-outs as well as EXTRA WIDTHS up to 1800 mm.</b>							
<b>Shortened side screen</b> 		<b>CUSTOM MEASUREMENTS - Measurement sketch needed.</b> Fits winged door or swinging door. Height 700 - 2200 mm. Width 200 - 1200 mm.				-	-
<b>Surcharge for triangular and rectangular cut-outs as well as EXTRA WIDTHS up to 1800 mm.</b>							

## IMPORTANT

- Required installation height is total height + 100 mm.
- Correct installation is only possible if the floor is horizontal and the walls are vertical.

Art. no.		Colour	Glazing	Glass finishing (optional)	Handle type/ towel holder	Brackets	
9 R							
Base price			Surcharge				
WM	left	right	VC Chrome WS White . . Additional colours	EK Glass clear RW Strip Satin SA Satin	C ARTCLEAR GLAZING	K Knob R Horizontal H Vertical G Bow-type T Towel holder	I inwards A outwards
up to 1000	9R2F1 69	9R2F2 69	1,698	EK 0 RW 259 SA 351	211	K 0 R 0 H 0 G 166 T -	I 0 A 0
up to 1200	9R2F1 B9	9R2F2 B9	1,828				
	9R2F1 88	9R2F2 88	1,966				
			275				
up to 1000	9R1F1 69	9R1F2 69	1,042	EK 0 RW 204 SA 351	211	K - R - H - G - T 252	I 0 A 0
	9R1F1 88	9R1F2 88	1,167				
			275				
up to 1000	9R3F1 69	9R3F2 69	1,730	EK 0 RW 259 SA 351	211	K 0 R 0 H 0 G 166 T -	I 0 A 0
	9R3F1 88	9R3F2 88	1,966				
			275				
up to 1200	9R601 88	9R602 88	1,066	EK 0 RW 204 SA 351	211	K - R - H - G - T 252	I 0 A 0
			275				

ARTWEGER 360  
frameless

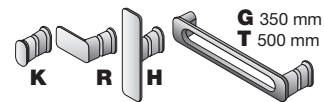

**IMPORTANT**

- ARTWEGER 360 FRAMELESS is individually custom adapted to the exact installation situation. Production can only take place upon presentation of an exact dimension sketch.
- When ordering please indicate assembly on shower tray or flush with floor.

# ARTWEGER 360 frameless

Winged door / Side screen 6 mm ESG

ARTWEGER price list 03/2023. For specialised trade outlets only. Suggested retail prices in EUR not including VAT.  
DIMENSIONS IN MILLIMETRES.

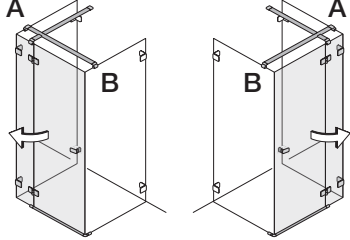
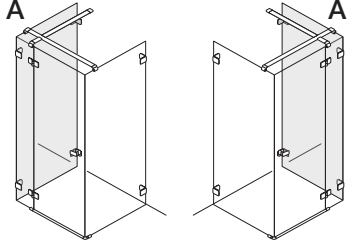
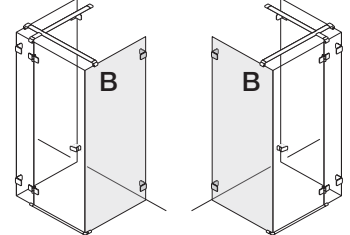
Hinge left	Hinge right	Height	Shower tray measurement (WM)	Overview of product features	Quantity stabilisers	Entrance width
<p><b>Winged door attached on fixed part for two side screens</b></p>  <p>1 door part and 1 fixed part</p>		2000	up to 1000	<ul style="list-style-type: none"> <li>• Installation on straight wall.</li> <li>• According to dimension sketch.</li> <li>• Including stabiliser for side screens.</li> </ul>	1	up to 680
<p><b>CUSTOM MEASUREMENTS</b> - Measurement sketch needed. Height 1500 - 2200 mm. Width up to 1400 mm. Door max. 750 mm.</p>						
<p><b>Side screen A next to winged door</b></p> 		2000	up to 1000	<ul style="list-style-type: none"> <li>• Installation on straight wall.</li> <li>• According to dimension sketch.</li> </ul>	-	-
<p><b>CUSTOM MEASUREMENTS</b> - Measurement sketch needed. Height 1500 - 2200 mm. Width up to 1200 mm.</p> <p><b>Surcharge for triangular and rectangular cut-outs.</b></p>						
<p><b>Side screen B next to winged door</b></p> 		2000	up to 1000	<ul style="list-style-type: none"> <li>• Installation on straight wall.</li> <li>• According to dimension sketch.</li> </ul>	-	-
<p><b>CUSTOM MEASUREMENTS</b> - Measurement sketch needed. Height 1500 - 2200 mm. Width up to 1200 mm.</p> <p><b>Surcharge for triangular and rectangular cut-outs.</b></p>						

## IMPORTANT

- Required installation height is total height + 100 mm.
- Correct installation is only possible if the floor is horizontal and the walls are vertical.
- For installing on a straight piece of wall 2 side screens are necessary. (1 × left and 1 × right).



Art.no.	Colour	Glazing	Glass finishing (optional)	Handle type/ towel holder	Brackets
9 R					

Base price

Surcharge

WM	left	right	VC Chrome WS White . . Additional colours	EK Glass clear RW Strip Satin SA Satin	C ARTCLEAR GLAZING	K Knob R Horizontal H Vertical G Bow-type T Towel holder	I inwards A outwards
up to 1000	9RGF1 69	9RGF2 69	1,698	EK 0 RW 259 SA 351	211	K 0 R 0 H 0 G 166 T -	I 0 A -
	9RGF1 88	9RGF2 88	1,966				
up to 1000	9RH01 69	9RH02 69	1,042	EK 0 RW 204 SA 351	211	K - R - H - G - T 252	I 0 A 0
	9RH01 88	9RH02 88	1,167 275				
up to 1000	9R1F2 69	9R1F1 69	1,042	EK 0 RW 204 SA 351	211	K - R - H - G - T 252	I 0 A 0
	9R1F2 88	9R1F1 88	1,167 275				

ARTWEGER 360  
frameless

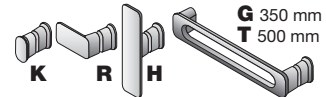

### IMPORTANT

- ARTWEGER 360 FRAMELESS is individually custom adapted to the exact installation situation. Production can only take place upon presentation of an exact dimension sketch.
- When ordering please indicate assembly on shower tray or flush with floor.

# ARTWEGER 360 frameless

Swinging door 6 mm ESG

ARTWEGER price list 03/2023. For specialised trade outlets only. Suggested retail prices in EUR not including VAT.  
DIMENSIONS IN MILLIMETRES.

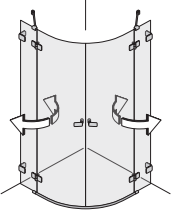
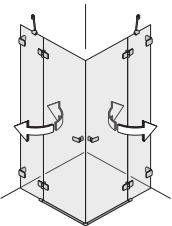
Hinge left	Hinge right	Height	Shower tray measurement (WM) length a x width b	Overview of product features	Quantity stabilisers depending on fixed part width	Entrance width	
<b>1/4-round shower</b> 		<b>2000</b>	800 x 800 I R=500	<ul style="list-style-type: none"> <li>According to dimension sketch.</li> </ul>	0-2	860	
2 swinging doors and 2 fixed parts			900 x 900 I R=500		0-2	860	
			900 x 900 II R=550		0-2	1000	
			1000 x 1000 II R=550		0-2	1000	
			900 x 800 I R=500		0-2	860	
			1000 x 900 II R=550		0-2	1000	
			<b>CUSTOM MEASUREMENTS</b> - Measurement sketch needed. fixed-part custom width (narrower or wider). Width max. 1200 x 1200 mm. Custom heights not available. <b>Surcharge for triangular and rectangular cut-outs.</b>				
		<b>Corner entry</b> 		<b>2000</b>	up to 1000 x 1000	<ul style="list-style-type: none"> <li>According to dimension sketch.</li> </ul>	0-2
2 swinging doors and 2 fixed parts		<b>CUSTOM MEASUREMENTS</b> - Measurement sketch needed. Height 1800 - 2200 mm. Width up to 1200 x 1200 mm. Door max. 750 mm. Price for combination of custom and standard measurement: (custom price + standard price) / 2. <b>Surcharge for triangular and rectangular cut-outs as well as EXTRA WIDTHS up to 1600 x 1600 mm.</b>					

## IMPORTANT

- With stabiliser: required installation height ist total height + 100 mm. Without stabiliser: required installation height is total height + 30 mm.
- ARTWEGER 360 FRAMELESS is individually custom adapted to the exact installation situation. Production can only take place upon presentation of an exact dimension sketch.

Art. no.		Colour	Glazing	Glass finishing (optional)	Handle type	Brackets
9	R					
Base price				Surcharge		

WM	left	right	VC Chrome WS White . . Additional colours	EK Glass clear RW Strip Satin SA Satin	C ARTCLEAR GLAZING	K Knob R Horizontal H Vertical G Bow-type	I inwards A outwards
800I	9RRP049		2,966				
900I	9RRP019		3,015				
900II	9RRP029			EK 0		K 0	I 0
1000II	9RRP069		3,173	RW -	417	R 0	A 0
900/800I	9RRP1 A9	9RRP2 A9	3,015	SA -		H 0	
1000/900II	9RRP1 C9	9RRP2 C9	3,173			G -	
	9RRP088		3,479				
			275				
up to 1000	9REP069		2,797	EK 0	417	K 0	I 0
				RW 518		R 0	A 0
				SA 692		H 0	
	9REP088		3,173			G 331	
			275				

ARTWEGER 360  
frameless

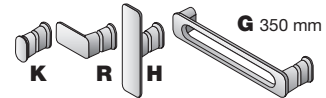

### IMPORTANT

- When ordering please indicate assembly on shower tray or flush with floor.
- The manufacture of individually curved glass is not possible. Dimension tolerances to the tiled shower area are possible for technical reasons.
- Correct installation is only possible if the floor is horizontal and the walls are vertical.

# ARTWEGER 360 frameless

Swinging door 6 mm ESG

ARTWEGER price list 03/2023. For specialised trade outlets only. Suggested retail prices in EUR not including VAT.  
DIMENSIONS IN MILLIMETRES.

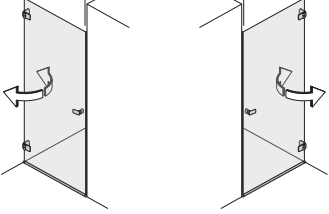
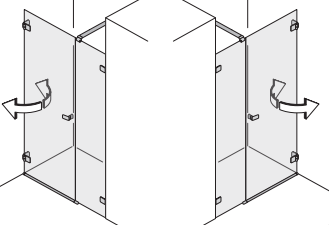
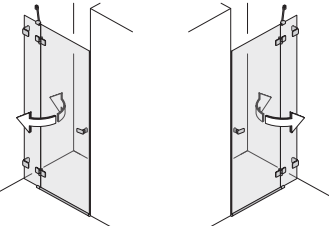
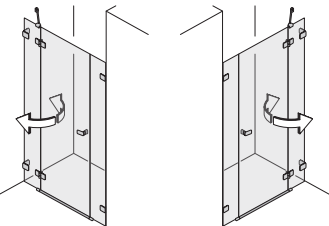
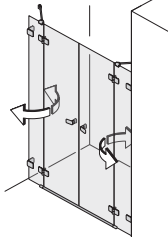
Hinge left	Hinge right	Height	Shower tray measurement (WM)	Overview of product features	Quantity stabilisers	Entrance width
<b>Swinging door in alcove</b>  1 door part without fixed part		2000	up to 900	<ul style="list-style-type: none"> <li>According to dimension sketch.</li> <li>Maximum allowance for sloping on the hinge side is 5 mm.</li> </ul>	-	up to 820
<b>CUSTOM MEASUREMENTS</b> - Measurement sketch needed. Height 1800 - 2200 mm. Width 820 mm. With height 2000 mm only. Width 900 mm. <b>Surcharge for triangular and rectangular cut-outs.</b>						
<b>Swinging door next to fixed part in alcove</b>  1 door part and 1 fixed part		2000	up to 1000 up to 1400	<ul style="list-style-type: none"> <li>According to dimension sketch.</li> <li>Maximum allowance for sloping on the hinge side is 5 mm.</li> <li>Stabiliser 1200 mm. Length must be adjusted on site.</li> </ul>	- 0-1	680 680
<b>CUSTOM MEASUREMENTS</b> - Measurement sketch needed. Height 1800 - 2200 mm. Width up to 1600 mm. door max. 820 mm. <b>Surcharge for triangular and rectangular cut-outs as well as EXTRA WIDTHS up to 2000 mm.</b>						
<b>Swinging door attached on fixed part in alcove</b>  1 door part and 1 fixed part		2000	up to 1000	<ul style="list-style-type: none"> <li>According to dimension sketch.</li> </ul>	0-1	up to 680
<b>CUSTOM MEASUREMENTS</b> - Measurement sketch needed. Height 1800 - 2200 mm. Width up to 1200 mm. One stabiliser included with custom widths 910 mm and wider. Door max. 750 mm. <b>Surcharge for triangular and rectangular cut-outs as well as EXTRA WIDTHS up to 1800 mm.</b>						
<b>Swinging door attached on fixed part in alcove</b>  1 door part and 2 fixed parts		2000	up to 1000 up to 1400	<ul style="list-style-type: none"> <li>According to dimension sketch.</li> </ul>	0-1 1	up to 580 up to 680
<b>CUSTOM MEASUREMENTS</b> - Measurement sketch needed. Height 1800 - 2200 mm. Width up to 1600 mm. Door max. 750 mm. <b>Surcharge for triangular and rectangular cut-outs as well as EXTRA WIDTHS up to 2000 mm.</b>						
<b>Swinging door attached on fixed part in alcove</b>  2 door parts and 2 fixed parts		2000	up to 1400 up to 1600 up to 1800	<ul style="list-style-type: none"> <li>According to dimension sketch.</li> </ul>	2 2 2	up to 970 up to 1170 up to 1170
<b>CUSTOM MEASUREMENTS</b> - Measurement sketch needed. Height 1800 - 2200 mm. Width up to 2000 mm. Door max. 750 mm. <b>Surcharge for triangular and rectangular cut-outs as well as EXTRA WIDTHS up to 2500 mm.</b>						

## IMPORTANT

- With stabiliser: required installation height ist total height + 100 mm.  
Without stabiliser: required installation height is total height + 30 mm.
- Correct installation is only possible if the floor is horizontal and the walls are vertical.

Art. no.		Colour	Glazing	Glass finishing (optional)	Handle type	Brackets	
9 R							
Base price			Surcharge				
WM	left	right	VC Chrome WS White . . Additional colours	EK Glass clear RW Strip Satin SA Satin	C ARTCLEAR GLAZING	K Knob R Horizontal H Vertical G Bow-type	I inwards A outwards
up to 900	9RTP1 59	9RTP2 59	1,478	EK 0 RW 204 SA -	211	K 0 R 0 H 0 G 166	I 0 A -
	9RTP1 88	9RTP2 88	1,695				
			275				
up to 1000	9R9P1 69	9R9P2 69	1,725	EK 0 RW 259 SA -	211	K 0 R 0 H 0 G 166	I 0 A -
up to 1400	9R9P1 E9	9R9P2 E9	1,849				
	9R9P1 88	9R9P2 88	1,992				
			275				
up to 1000	9R5P1 69	9R5P2 69	1,725	EK 0 RW 259 SA 351	211	K 0 R 0 H 0 G 166	I 0 A 0
	9R5P1 88	9R5P2 88	1,992				
			275				
up to 1000	9R4P1 69	9R4P2 69	1,927	EK 0 RW 259 SA 351	211	K 0 R 0 H 0 G 166	I 0 A 0
up to 1400	9R4P1 E9	9R4P2 E9	2,067				
	9R4P1 88	9R4P2 88	2,333				
			275				
up to 1400	9RDP0 E9		2,797	EK 0 RW 518 SA 692	417	K 0 R 0 H 0 G 331	I 0 A 0
up to 1600	9RDP0 K9						
up to 1800	9RDP0 P9						
	9RDP0 88		3,173				
			275				

ARTWEGER 360  
frameless

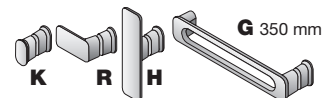

### IMPORTANT

- ARTWEGER 360 FRAMELESS is individually custom adapted to the exact installation situation. Production can only take place upon presentation of an exact dimension sketch.
- When ordering please indicate assembly on shower tray or flush with floor.

# ARTWEGER 360 frameless

Swinging door / Side screen 6 mm ESG

ARTWEGER price list 03/2023. For specialised trade outlets only. Suggested retail prices in EUR not including VAT.  
DIMENSIONS IN MILLIMETRES.

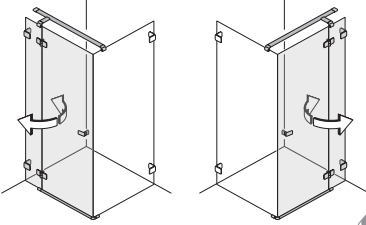
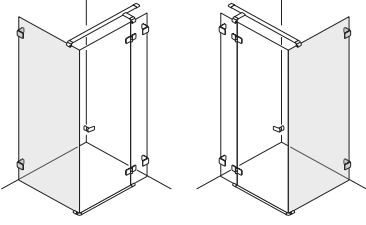
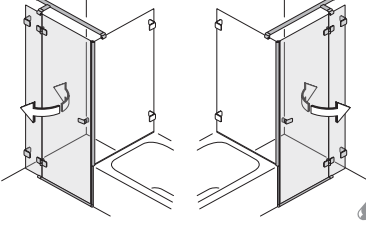
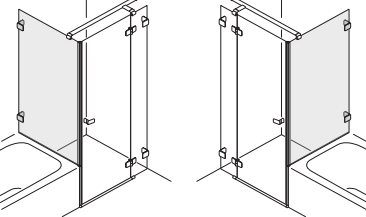
Hinge left	Hinge right	Height	Shower tray measurement (WM)	Overview of product features	Quantity stabilisers	Entrance width
<b>Swinging door attached on fixed part next to side screen</b> 		<b>2000</b>	up to 1000 up to 1200	<ul style="list-style-type: none"> <li>• Hinge always on the wall side.</li> <li>• According to dimension sketch.</li> <li>• Stabiliser 1200 mm. Length must be adjusted on site.</li> </ul>	1  1	up to 680  680
1 door part and 1 fixed part						
<b>CUSTOM MEASUREMENTS</b> - Measurement sketch needed. Height 1800 - 2200 mm. Width up to 1300 mm. Door max. 750 mm.						
<b>Surcharge for triangular and rectangular cut-outs as well as EXTRA WIDTHS up to 1800 mm.</b>						
<b>Side screen next to swinging door</b> 		<b>2000</b>	up to 1000	<ul style="list-style-type: none"> <li>• According to dimension sketch.</li> </ul>	-	-
1 door part and 1 fixed part						
<b>CUSTOM MEASUREMENTS</b> - Measurement sketch needed. Height 1800 - 2200 mm. Width up to 1200 mm.						
<b>Surcharge for triangular and rectangular cut-outs as well as EXTRA WIDTHS up to 1800 mm.</b>						
<b>Swinging door attached on fixed part next to shortened side screen</b> 		<b>2000</b>	up to 1000	<ul style="list-style-type: none"> <li>• Hinge always on the wall side.</li> <li>• According to dimension sketch.</li> <li>• Stabiliser 1200 mm. Length must be adjusted on site.</li> </ul>	1	up to 680
1 door part and 1 fixed part						
<b>CUSTOM MEASUREMENTS</b> - Measurement sketch needed. Height 1800 - 2200 mm. Width up to 1300 mm. Door max. 750 mm.						
<b>Surcharge for triangular and rectangular cut-outs as well as EXTRA WIDTHS up to 1800 mm.</b>						
<b>Shortened side screen</b> 		<b>CUSTOM MEASUREMENTS</b> - Measurement sketch needed. Fits winged door or swinging door. Height 700 - 2200 mm. Width 200 - 1200 mm.			-	-
<b>Surcharge for triangular and rectangular cut-outs as well as EXTRA WIDTHS up to 1800 mm.</b>						

## IMPORTANT

- Required installation height is total height + 100 mm.
- Correct installation is only possible if the floor is horizontal and the walls are vertical.

Art. no.		Colour	Glazing	Glass finishing (optional)	Handle type/ towel holder	Brackets	
9 R							
Base price			Surcharge				
WM	left	right	VC Chrome WS White . . Additional colours	EK Glass clear RW Strip Satin SA Satin	C ARTCLEAR GLAZING	K Knob R Horizontal H Vertical G Bow-type T Towel holder	I inwards A outwards
up to 1000	9R2P1 69	9R2P2 69	1,725	EK 0 RW 259 SA 351	211	K 0 R 0 H 0 G 166 T -	I 0 A 0
up to 1200	9R2P1 B9	9R2P2 B9	1,855				
	9R2P1 88	9R2P2 88	1,992 275				
up to 1000	9R1P1 69	9R1P2 69	1,042	EK 0 RW 204 SA 351	211	K - R - H - G - T 252	I 0 A 0
	9R1P1 88	9R1P2 88	1,167 275				
up to 1000	9R3P1 69	9R3P2 69	1,756	EK 0 RW 259 SA 351	211	K 0 R 0 H 0 G 166 T -	I 0 A 0
	9R3P1 88	9R3P2 88	1,992 275				
	9R601 88	9R602 88	1,066	EK 0 RW 204 SA 351	211	K - R - H - G - T 252	I 0 A 0
			275				

ARTWEGER 360  
frameless

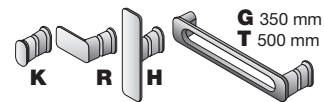

### IMPORTANT

- ARTWEGER 360 FRAMELESS is individually custom adapted to the exact installation situation. Production can only take place upon presentation of an exact dimension sketch.
- When ordering please indicate assembly on shower tray or flush with floor.

# ARTWEGER 360 frameless

Swinging door / Side screen 6 mm ESG

ARTWEGER price list 03/2023. For specialised trade outlets only. Suggested retail prices in EUR not including VAT.  
DIMENSIONS IN MILLIMETRES.

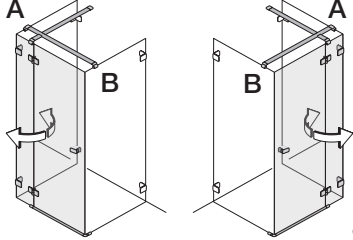
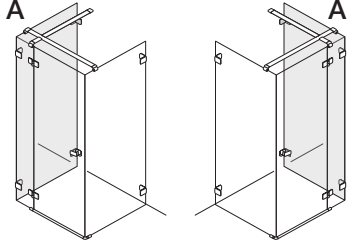
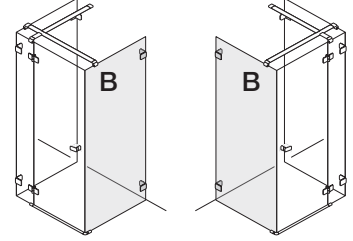
Hinge left	Hinge right	Height	Shower tray measurement (WM)	Overview of product features	Quantity stabilisers	Entrance width
<b>Swinging door attached on fixed part for two side screens</b> 		2000	up to 1000	<ul style="list-style-type: none"> <li>• Installation on straight wall.</li> <li>• According to dimension sketch.</li> <li>• Including stabiliser for side screens.</li> </ul>	1	up to 680
<b>CUSTOM MEASUREMENTS</b> - Measurement sketch needed. Height 1800 - 2200 mm. Width up to 1400 mm. Door max. 750 mm.						
<b>Side screen A next to swinging door</b> 		2000	up to 1000	<ul style="list-style-type: none"> <li>• Installation on straight wall.</li> <li>• According to dimension sketch.</li> </ul>	-	-
<b>CUSTOM MEASUREMENTS</b> - Measurement sketch needed. Height 1800 - 2200 mm. Width up to 1200 mm. <b>Surcharge for triangular and rectangular cut-outs.</b>						
<b>Side screen B next to swinging door</b> 		2000	up to 1000	<ul style="list-style-type: none"> <li>• Installation on straight wall.</li> <li>• According to dimension sketch.</li> </ul>	-	-
<b>CUSTOM MEASUREMENTS</b> - Measurement sketch needed. Height 1800 - 2200 mm. Width up to 1200 mm. <b>Surcharge for triangular and rectangular cut-outs.</b>						

## IMPORTANT

- Required installation height is total height + 100 mm.
- Correct installation is only possible if the floor is horizontal and the walls are vertical.
- For installing on a straight piece of wall 2 side screens are necessary. (1 × left and 1 × right).



Art. no.		Colour	Glazing	Glass finishing (optional)	Handle type/ towel holder	Brackets
9	R					

Base price

Surcharge

WM	left	right	VC Chrome WS White . . Additional colours	EK Glass clear RW Strip Satin SA Satin	C ARTCLEAR GLAZING	K Knob R Horizontal H Vertical G Bow-type T Towel holder	I inwards A outwards
up to 1000	9RGP1 69	9RGP2 69	1,725	EK 0 RW 259 SA 351	211	K 0 R 0 H 0 G 166 T -	I 0 A -
	9RGP1 88	9RGP2 88	1,992				
up to 1000	9RH01 69	9RH02 69	1,042	EK 0 RW 204 SA 351	211	K - R - H - G - T 252	I 0 A 0
	9RH01 88	9RH02 88	1,167 275				
up to 1000	9R1P2 69	9R1P1 69	1,042	EK 0 RW 204 SA 351	211	K - R - H - G - T 252	I 0 A 0
	9R1P2 88	9R1P1 88	1,167 275				

ARTWEGER 360  
frameless

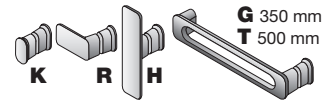

**IMPORTANT**

- ARTWEGER 360 FRAMELESS is individually custom adapted to the exact installation situation. Production can only take place upon presentation of an exact dimension sketch.
- When ordering please indicate assembly on shower tray or flush with floor.

# ARTWEGER 360 frameless

Swinging door 6 mm ESG

ARTWEGER price list 03/2023. For specialised trade outlets only. Suggested retail prices in EUR not including VAT.  
DIMENSIONS IN MILLIMETRES.

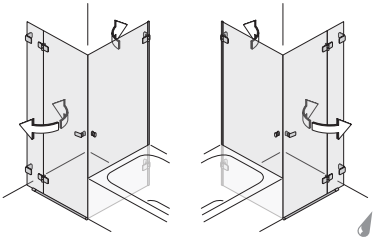
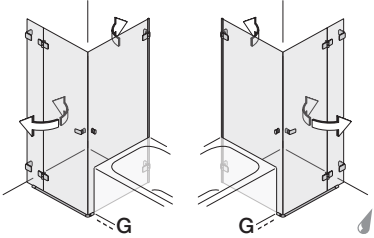
Hinge left	Hinge right	Height	Shower tray measurement (WM)	Overview of product features	Entrance width
<p><b>Swinging door attached on fixed part with swinging side screen next to bathtub</b></p>  <p>1 door part and 1 fixed part</p>		2000	up to 900 x 900	<ul style="list-style-type: none"> <li>According to dimension sketch.</li> </ul>	up to 680
<p><b>CUSTOM MEASUREMENTS</b> - Measurement sketch needed. Height 1800 - 2200 mm. Width: door up to 1200 mm, side screen up to 900 mm. Door max. 750 mm. Price for combination of custom and standard measurement: (custom price + standard price) / 2.</p>					
<p><b>Swinging door attached on fixed part with swinging side screen next to bathtub</b></p>  <p>1 door part and 1 fixed part</p>		2000	up to 900 x 900	<ul style="list-style-type: none"> <li>Shower tray and bathtub not flush.</li> <li>According to dimension sketch.</li> </ul>	up to 680
<p><b>CUSTOM MEASUREMENTS</b> - Measurement sketch needed. Height 1800 - 2200 mm. Width: door up to 1200 mm, side screen up to 900 mm. Door max. 750 mm. Price for combination of custom and standard measurement: (custom price + standard price) / 2.</p>					

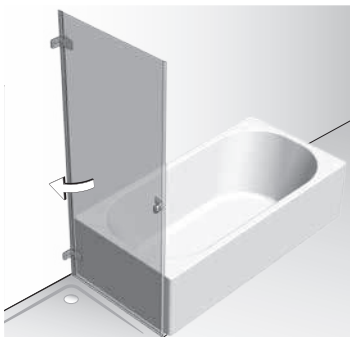

Detail of the swinging side screen when adjoined to the bathtub.

## IMPORTANT

- Required installation height is total height + 100 mm.
- Correct installation is only possible if the floor is horizontal and the walls are vertical.

Art. no.		Colour	Glazing	Glass finishing (optional)	Handle type/ towel holder	Brackets
9	R					
Base price			Surcharge			

WM	left	right	VC Chrome WS White . . Additional colours	EK Glass clear RW Strip Satin SA Satin	C ARTCLEAR GLAZING	K Knob R Horizontal H Vertical G Bow-type	I inwards A outwards
up to 900	9RAP1 59	9RAP2 59	2,914	EK 0 RW 518 SA -	417	K 0 R 0 H 0 G 166	I 0 A 0
	9RAP1 88	9RAP2 88	3,308				
up to 900	9RBP1 59	9RBP2 59	2,914	EK 0 RW 518 SA -	417	K 0 R 0 H 0 G 166	I 0 A 0
	9RBP1 88	9RBP2 88	3,308				

ARTWEGER 360  
frameless

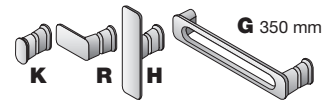

### IMPORTANT

- ARTWEGER 360 FRAMELESS is individually custom adapted to the exact installation situation. Production can only take place upon presentation of an exact dimension sketch.
- When ordering please indicate assembly on shower tray or flush with floor.

# ARTWEGER 360 Sliding doors

Incomparable smooth running.

- Floor-guided sliding doors
- 4-point guidance
- Lower guidance rail only 6 mm high with Vario sealing system
- A well-designed range of grips and handles in a variety of materials
- Wall profile with 3D adjustment and concealed silicone joint
- Certified adhesion technique
- 8 mm single-pane safety glass
- Standard height 2000 mm
- Adjustment range 20 mm
- Custom sizes available

## HANDLE TYPES

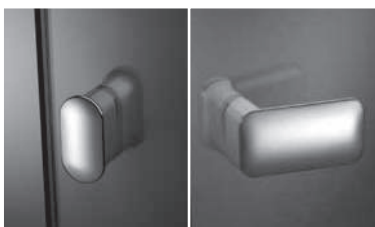

Knob **K**

Horizontal **R**

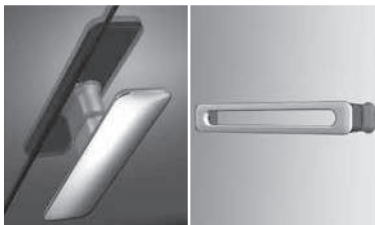

Vertical **H**

Bow-type **G**



**FLOOR-GUIDED DOORS:** Rollers on ball bearings glide softly and safely like on tracks. Due to the 4-point guidance of the doors, larger door widths are enabled.

Overflow moulding is always in the color **METAL HIGH GLOSS**.



**ROLLERSYSTEM INSIDE:** Easy cleaning due to the roller system adhered to the outside.



The ARTWEGER 360 SLIDING DOOR distinguishes itself due to its special stability and water-tightness. These are achieved by means of the floor guidance of the doors. In this way a four point fixation of the sliding doors is enabled - and therefore incomparable stability and smooth running.

**Artweger**

**artclear**  
GLASS

**CE**

according to EN 14428

# ACCESSORIES

ARTWEGER price list 03/2023. For specialised trade outlets only.  
Suggested retail prices in EUR not including VAT. DIMENSIONS IN MILLIMETRES.

Art. no.				Colour	
9	0				
Base price					

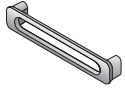

	Width	Art. no.	VC Chrome WS White . . Additional colours
<b>Towel holder</b> For installation on tiled walls.	550	<b>90011</b>	252

## IMPORTANT

- We will gladly send you the documents in hard copy on request.

# ARTWEGER 360 Sliding doors

with frame 8 mm ESG

ARTWEGER price list 03/2023. For specialised trade outlets only. Suggested retail prices in EUR not including VAT.  
DIMENSIONS IN MILLIMETRES.

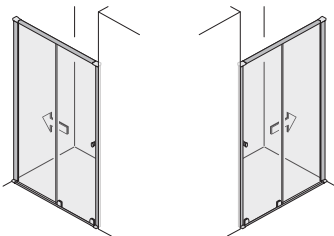
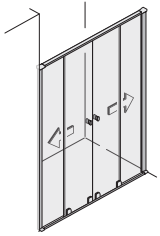
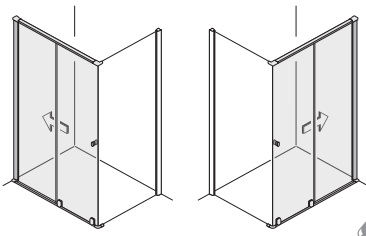
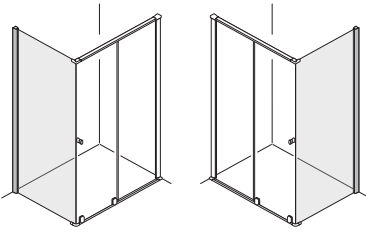
Fixed part left	Fixed part right	Height	Shower tray measurement (WM)	Shower tray installation measurement	Fixed part width	Entrance width
<b>Double sliding door in alcove</b>  1 door part and 1 fixed part		<b>2000</b>	1000	970 - 1010	470 - 490	390 - 410
			1200	1170 - 1210	570 - 590	490 - 510
			1400	1370 - 1410	670 - 690	590 - 610
			1600	1570 - 1610	770 - 790	690 - 710
			<b>CUSTOM MEASUREMENTS</b> - Measurement sketch needed. Height 1800 - 2200 mm. Shower tray installation measurement 1000 - 1800 mm.			
<b>Quadruple sliding door in alcove</b>  2 door parts and 2 fixed parts		<b>2000</b>	1600	1560 - 1610	370 - 390	610 - 660
			1800	1760 - 1810	420 - 440	710 - 760
			2000	1960 - 2010	470 - 490	810 - 860
		<b>CUSTOM MEASUREMENTS</b> - Measurement sketch needed. Height 1800 - 2200 mm. Shower tray installation measurement 1400 - 2000 mm.				
<b>Double sliding door next to side screen</b>  1 door part and 1 fixed part		<b>2000</b>	1000	980 - 1000	450 - 470	380 - 400
			1200	1180 - 1200	550 - 570	480 - 500
			1400	1380 - 1400	650 - 670	580 - 600
		<b>CUSTOM MEASUREMENTS</b> - Measurement sketch needed. Height 1800 - 2200 mm. Shower tray installation measurement 1000 - 1800 mm.				
<b>Side screen</b>  1 door part and 1 fixed part		<b>2000</b>	800	780 - 800	-	-
			900	880 - 900	-	-
			1000	980 - 1000	-	-
			1200	1180 - 1200	-	-
		<b>CUSTOM MEASUREMENTS</b> - Measurement sketch needed. Height 1800 - 2200 mm. Shower tray installation measurement 700 - 1200 mm. <b>Surcharge for triangular and rectangular cut-outs as well as EXTRA WIDTHS up to 1800 mm.</b>				

## IMPORTANT

- Required installation height is total height + 100 mm.
- Our track is always in the color METAL HIGH GLOSS.

Art. no.		Frame colour	Glazing	Glass finishing (optional)	Handle type/ towel holder	Colour Handle/towel holder	
9 G							
Base price			Surcharge				
WM	left	right	MH High-gloss metal WS White . . Additional colours	EK Glass clear RW Strip Satin	C ARTCLEAR GLAZING	K Knob R Horizontal H Vertical G Bow-type T Towel holder	WS White <sup>1</sup> VC Chrome
1000	9G5S1 69	9G5S2 69	1,711			K 0	
1200	9G5S1 B9	9G5S2 B9	1,771	EK 0		R 0	WS 0
1400	9G5S1 E9	9G5S2 E9	1,851	RW 259	316	H 0	VC 0
1600	9G5S1 K9	9G5S2 K9	1,984			G 166	
						T -	
	9G5S1 88	9G5S2 88	2,298				
1600	9GDS0 K9		2,782	EK 0		K 0	WS 0
1800	9GDS0 P9		2,836	RW 461	417	R 0	VC 0
2000	9GDS0 U9		2,904			H 0	
						G 331	
						T -	
	9GDS0 88		3,103				
1000	9G2S1 69	9G2S2 69	1,683	EK 0		K 0	WS 0
1200	9G2S1 B9	9G2S2 B9	1,719	RW 259	211	R 0	VC 0
1400	9G2S1 E9	9G2S2 E9	1,767			H 0	
						G 166	
						T -	
	9G2S1 88	9G2S2 88	2,049				
800	9G1S1 49	9G1S2 49	970	EK 0		K -	WS 0
900	9G1S1 59	9G1S2 59		RW 204	211	R -	VC 0
1000	9G1S1 69	9G1S2 69	1,026			H -	
1200	9G1S1 B9	9G1S2 B9	1,113			G -	
						T 252	
	9G1S1 88	9G1S2 88	1,197				
			322				

ARTWEGER 360  
Sliding doors

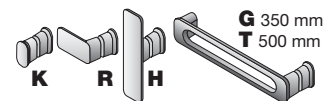

### IMPORTANT

• When ordering please indicate assembly on shower tray or flush with floor.

<sup>1</sup> Only in combination with the color WS white. For all the other colors VC chrome is standard.

# ARTWEGER 360 Sliding doors

with frame 8 mm ESG

ARTWEGER price list 03/2023. For specialised trade outlets only. Suggested retail prices in EUR not including VAT.  
DIMENSIONS IN MILLIMETRES.

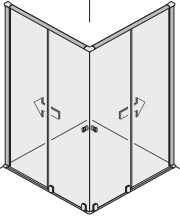
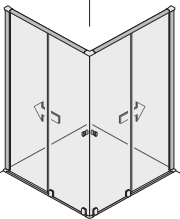
	Height	Shower tray measurement (WM)	Shower tray installation measurement	Fixed part width	Entrance width
<b>Corner entry</b>  2 Sliding doors and 2 fixed parts	<b>2000</b>	800 × 800	780 - 800	350 - 370	400 - 430
		900 × 800	880 - 900 × 780 - 800	400 - 420 × 350 - 370	435 - 465
		left 800 × 900 right	780 - 800 × 880 - 900	350 - 370 × 400 - 420	435 - 465
		1000 × 800	980 - 1000 × 780 - 800	450 - 470 × 350 - 370	470 - 500
		800 × 1000	780 - 800 × 980 - 1000	350 - 370 × 450 - 470	470 - 500
		<b>CUSTOM MEASUREMENTS</b> - Measurement sketch needed. Height 1800 - 2200 mm. Shower tray installation measurement 750 - 1200 mm. Price for combination of custom and standard measurement: (custom price + standard price) / 2.			
<b>Corner entry</b>  2 Sliding doors and 2 fixed parts	<b>2000</b>	900 × 900	880 - 900	400 - 420	470 - 500
		1000 × 1000	980 - 1000	450 - 470	540 - 570
		1200 × 1200	1180 - 1200	550 - 570	680 - 710
		<b>CUSTOM MEASUREMENTS</b> - Measurement sketch needed. Height 1800 - 2200 mm. Shower tray installation measurement 900 - 1200 mm. Price for combination of custom and standard measurement: (custom price + standard price) / 2.			

## IMPORTANT

- Required installation height is total height + 100 mm.
- Our track is always in the color METAL HIGH GLOSS.



Art. no.	Frame colour	Glazing	Glass finishing (optional)	Handle type	Handle colour
9 G					
Base price			Surcharge		

WM	Art. no.	MH High-gloss metal WS White . . Additional colours	EK Glass clear RW Strip Satin	C ARTCLEAR GLAZING	K Knob R Horizontal H Vertical G Bow-type	WS White <sup>1</sup> VC Chrome
800	<b>9GES0 49</b>	2,811				
900/800	<b>9GES0 99</b>	2,837	EK 0 RW 518	417	K 0 R 0 H 0 G -	WS 0 VC 0
800/900	<b>9GES0 79</b>					
1000/800	<b>9GES0 F9</b>	2,876				
800/1000	<b>9GES0 E9</b>					
	<b>9GES0 88</b>	3,108			Installation of bow-type handles only possible as of size 900 x 900 mm. See below.	
900	<b>9GESH 59</b>	2,868	EK 0 RW 518	417	K 0 R 0 H 0 G 331	WS 0 VC 0
1000	<b>9GESH 69</b>	2,929				
1200	<b>9GESH B9</b>	2,969				
	<b>9GESH 88</b>	3,206				

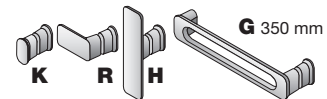

ARTWEGER 360  
Sliding doors

**Did you not find a suitable model?**  
**We have the right solution for your very special wishes for your own bathroom.**  
**Contact us!**  
**ARTWEGER – Your specialist for customized, individual solutions!**

**IMPORTANT**

- When ordering please indicate assembly on shower tray or flush with floor.
- <sup>1</sup> Only in combination with the color WS white. For all the other colors VC chrome is standard.

# Anniversary Edition Artweger PRO:TECT



- **Mounting without drilling**
- Swinging doors with fixed parts
- Swinging doors with 360° TWIN hinge
- Barrier-free with Vario sealing system
- Certified adhesion technique
- Raise and lower mechanism

- Wall profile with 3D adjustment
- 6 mm single-pane safety glass, Artweger PROTECT Walk In 8 mm
- Standard height 2000 mm
- Adjustment range 20 mm
- Custom sizes available

## Colour combinations:

- Wall profile, hinge and handle base colour
- hinge and handle front colour



- High-gloss metal
- Matt aluminium



- High-gloss metal
- Graphite



- Matt white
- Graphite



- Matt black
- Graphite



Artweger®

artclear  
GLASS

CE

according to EN 14428



**Mounting without drilling.**  
Quick and safe with adhesive technique.

**Le système de collage ART-FIX**  
is universally applicable for all

substrates that are fully load-bearing, flat, dry, free of dust and grease, sealed against moisture and free of adhesion-reducing substances.



VARIO sealing system:  
You decide either for 100 %  
FLUSH-TO-FLOOR ACCESS or ...

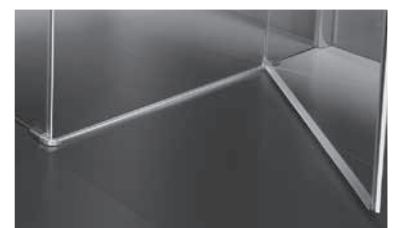

... for an optional surge bar which  
is only 12 mm high and provides  
IMPROVED SEALING of the door.

# ACCESSORIES

ARTWEGER price list 03/2023. For specialised trade outlets only.  
Suggested retail prices in EUR not including VAT. DIMENSIONS IN MILLIMETRES.

Art. no.				Colour	
P	R				
Base price					

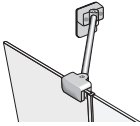
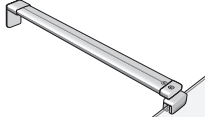
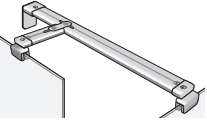
	Length	Art. no.	MH High-gloss metal	WM Matt white SM Matt black
 <p><b>Stabiliser 45°</b> Fits quarter-round shower, doors and corner entry.</p>	ca. 300	<b>PR00 01</b>	171	197
	ca. 430	<b>PR00 02</b>	186	214
 <p><b>Side-screen stabiliser 90°</b> Length has to be adjusted on site.</p>	ca. 1200	<b>PR00 03</b>	198	228
 <p><b>T-Stabilizer</b> Length has to be adjusted on site.</p>	ca. 1200	<b>PR00 04</b>	267	307



Artweger  
PROTECT

LEFT/RIGHT in the case of an asymmetric shower tray

LEFT  
PRR1 A9  
PRR1 C9

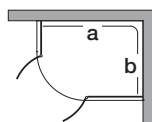
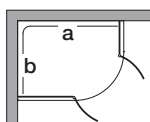

RIGHT  
PRR2 A9  
PRR2 C9

## IMPORTANT

- We will gladly send you the documents in hard copy on request.

# Anniversary Edition Artweger PRO:TECT swinging door partially framed

6 mm ESG

ARTWEGER price list 03/2023. For specialised trade outlets only. Suggested retail prices in EUR not including VAT.  
DIMENSIONS IN MILLIMETRES.

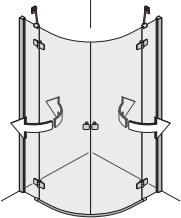
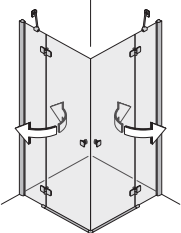
Hinge left	Hinge right	Height	Shower tray measurement (WM) length a x width b	Shower tray installation measurement	Fixed part width Quantity stabilisers	Entrance width
<b>1/4-round shower</b>						
						
2 swinging doors and 2 fixed parts						
		<b>2000</b>	<b>800 x 800 I</b> R=500	783 - 803	143 - 163 -	860
			<b>900 x 900 I</b> R=500	883 - 903	243 - 263 2	860
			<b>900 x 900 II</b> R=550	883 - 903	143 - 163 -	1000
			<b>1000 x 1000 II</b> R=550	983 - 1003	243 - 263 2	1000
			<b>900 x 800 I</b> R=500	883 - 903 x 783 - 803	243 - 263 x 143 - 163 1	860
			<b>1000 x 900 II</b> R=550	983 - 1003 x 883 - 903	243 - 263 x 143 - 163 1	1000
<b>CUSTOM MEASUREMENTS</b> - Measurement sketch needed. fixed-part custom width (narrower or wider). Width max. 1200 x 1200 mm. Custom heights not available. <b>Surcharge for triangular and rectangular cut-outs.</b>						
<b>Corner entry</b>						
						
2 swinging doors and 2 fixed parts						
		<b>2000</b>	<b>800 x 800</b>	783 - 803	243 - 263 2	710
			<b>900 x 900</b>	883 - 903	243 - 263 2	850
			<b>900 x 750</b>	883 - 903 x 733 - 753	243 - 263 x 193 - 213 1	780
	left		<b>750 x 900</b>	733 - 753 x 883 - 903	193 - 213 x 243 - 263 1	780
	right		<b>900 x 800</b>	883 - 903 x 783 - 803	243 - 263 x 243 - 263 2	780
			<b>800 x 900</b>	783 - 803 x 883 - 903	243 - 263 x 243 - 263 2	780
			<b>1000 x 1000</b>	983 - 1003	343 - 363 2	850
<b>CUSTOM MEASUREMENTS</b> - Measurement sketch needed. Height 1800 - 2200 mm. Shower tray installation measurement 700 - 1200 mm. Door max. 690 mm. Price for combination of custom and standard measurement: (custom price + standard price) / 2. <b>Surcharge for triangular and rectangular cut-outs as well as EXTRA WIDTHS up to 1600 x 1600 mm.</b>						





## IMPORTANT

- With stabiliser: required installation height ist total height + 100 mm.  
Without stabiliser: required installation height is total height + 30 mm.
- When ordering please indicate assembly on shower tray or flush with floor.

Art. no.		Colour		Glazing		Glass finishing (optional)	
P	R						

Base price

Surcharge

WM	left	right	MA High-gloss metal Matt aluminium	WP Matt white Graphite	EK Glass clear RW Strip Satin SA Satin	C ARTCLEAR GLAZING  ANNIVERSARY EDITION: ARTCLEAR GLAS including ARTSHOWER Softedge hand shower PLUS.
800I	PRR0 49		2,924	3,149		
900I	PRR0 19		2,969	3,194	EK 0 RW - SA -	417 + 
900II	PRR0 29					
1000II	PRR0 69					
900/800I	PRR1 A9	PRR2 A9	2,969	3,194		
1000/900II	PRR1 C9	PRR2 C9	3,148	3,373		
	PRR0 88		3,407	3,632		
			322	322		
800	PRE0 49		2,403	2,628	EK 0 RW 518 SA 692	417 + 
900	PRE0 59					
900/750	PRE0 D9					
750/900	PRE0 C9					
900/800	PRE0 99					
800/900	PRE0 79		2,718	2,943		
1000	PRE0 69		2,930	3,155		
	PRE0 88		322	322		



Artweger  
PROTECT

### IMPORTANT

- The manufacture of individually curved glass is not possible. Dimension tolerances to the tiled shower area are possible for technical reasons.

# Anniversary Edition Artweger PRO:TECT swinging door partially framed

6 mm ESG

ARTWEGER price list 03/2023. For specialised trade outlets only. Suggested retail prices in EUR not including VAT.  
DIMENSIONS IN MILLIMETRES.

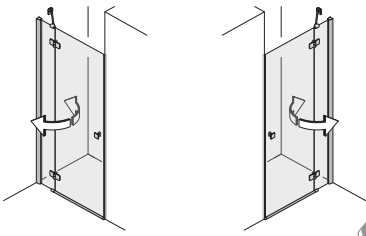
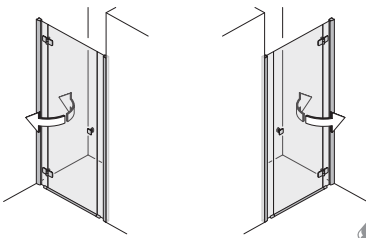
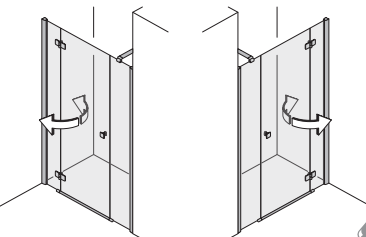
Hinge left	Hinge right	Height	Shower tray measurement (WM)	Shower tray installation measurement	Fixed part width Quantity stabilisers	Entrance width	
<b>Swinging door attached on fixed part in alcove</b> 		<b>2000</b>	750	733 - 753	153 - 173	-	530
1 door part and 1 fixed part			800	783 - 803	153 - 173	-	580
			900	883 - 903	153 - 173	-	680
			1000	983 - 1003	253 - 273	1	680
<b>CUSTOM MEASUREMENTS</b> - Measurement sketch needed. Height 1800 - 2200 mm. Shower tray installation measurement 750 - 1200 mm. Door max. 690 mm. One stabiliser included with widths 1000 mm and wider. <b>Surcharge for triangular and rectangular cut-outs as well as EXTRA WIDTHS up to 1800 mm.</b>							
<b>Swinging door attached on fixed part in alcove</b> 		<b>2000</b>	900	863 - 903	153 - 173	-	530
1 door part and 2 fixed parts			1000	963 - 1003	183 - 203	-	580
			1200	1163 - 1203	233 - 253	-	680
<b>CUSTOM MEASUREMENTS</b> - Measurement sketch needed. Height 1500 - 2200 mm. Shower tray installation measurement 900 - 1400 mm. Door max. 690 mm. One stabiliser included with widths 1200 mm and wider. <b>Surcharge for triangular and rectangular cut-outs.</b>							
<b>Swinging door attached on fixed part in alcove extra wide</b> 		<b>2000</b>	1400	1363 - 1403	233 - 253 / 423 - 443	-	680
1 door part and 2 fixed parts			1500	1463 - 1503	233 - 253 / 523 - 543	1	680
			1600	1563 - 1603	233 - 253 / 623 - 643	1	680
			1700	1663 - 1703	233 - 253 / 723 - 743	1	680
			1800	1763 - 1803	233 - 253 / 823 - 843	1	680
Stabiliser 1200 mm. Length must be adjusted on site. <b>CUSTOM MEASUREMENTS</b> - Measurement sketch needed. Height 1800 - 2200 mm. Shower tray installation measurement 1400 - 2000 mm. Door max. 690 mm. <b>Surcharge for triangular and rectangular cut-outs.</b>							





## IMPORTANT

- With stabiliser: required installation height ist total height + 100 mm.  
Without stabiliser: required installation height is total height + 30 mm.

Art. no.		Colour		Glazing		Glass finishing (optional)	
P	R						

Base price

Surcharge

WM	left	right	MA High-gloss metal Matt aluminium	WP Matt white Graphite	EK Glass clear RW Strip Satin SA Satin	C ARTCLEAR GLAZING  ANNIVERSARY EDITION: ARTCLEAR GLAS including ARTSHOWER Softedge hand shower PLUS.
750	PR51 39	PR52 39	1,441	1,666		211 + 
800	PR51 49	PR52 49	1,453	1,678	EK 0	
900	PR51 59	PR52 59	1,466	1,691	RW 259	
1000	PR51 69	PR52 69	1,502	1,727	SA 351	
	PR51 88	PR52 88	1,727	1,952		
			322	322		
900	PR41 59	PR42 59	1,674	1,899	EK 0	211 + 
1000	PR41 69	PR42 69	1,707	1,932	RW 259	
1200	PR41 B9	PR42 B9	1,832	2,057	SA 351	
	PR41 88	PR42 88	2,044	2,269		
			322	322		
1400	PR43 E9	PR44 E9	2,057	2,282	EK 0	417 + 
1500	PR43 H9	PR44 H9	2,158	2,383	RW 461	
1600	PR43 K9	PR44 K9	2,348	2,573	SA 692	
1700	PR43 M9	PR44 M9	2,571	2,796		
1800	PR43 P9	PR44 P9	2,626	2,851		
	PR43 88	PR44 88	2,799	3,024		
			322	322		

Artweger  
PROTECT



**IMPORTANT**

- When ordering please indicate assembly on shower tray or flush with floor.

# Anniversary Edition Artweger PRO:TECT swinging door partially framed

6 mm ESG

ARTWEGER price list 03/2023. For specialised trade outlets only. Suggested retail prices in EUR not including VAT.  
DIMENSIONS IN MILLIMETRES.

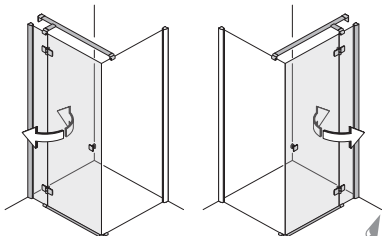
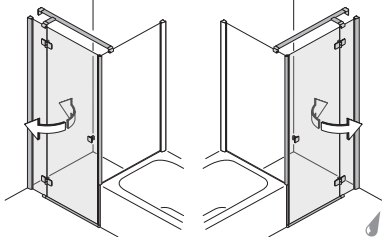
Hinge left	Hinge right	Height	Shower tray measurement (WM)	Shower tray installation measurement	Fixed part width Quantity stabilisers	Entrance width	
<b>Swinging door attached on fixed part next to side screen</b>  1 door part and 1 fixed part		<b>2000</b>	800	783 - 803	183 - 203	1	530
	900		883 - 903	183 - 203	1	630	
	1000		983 - 1003	233 - 253	1	680	
	1200		1183 - 1203	433 - 453	1	680	
Hinge always on the wall side. Incl. stabiliser for side screen. Length has to be adjusted on site.							
<b>CUSTOM MEASUREMENTS</b> - Measurement sketch needed. Height 1800 - 2200 mm. Shower tray installation measurement 700 - 1300 mm. Door max. 690 mm.							
<b>Surcharge for triangular and rectangular cut-outs as well as EXTRA WIDTHS up to 1800 mm.</b>							
<b>Swinging door attached on fixed part next to shortened side screen</b>  1 door part and 1 fixed part		<b>2000</b>	800	783 - 803	153 - 173	1	580
	900		883 - 903	153 - 173	1	680	
	1000		983 - 1003	253 - 273	1	680	
Incl. stabiliser for side screen. Length has to be adjusted on site.							
<b>CUSTOM MEASUREMENTS</b> - Measurement sketch needed. Height 1800 - 2200 mm. Shower tray installation measurement 700 - 1300 mm. Door max. 690 mm.							
<b>Surcharge for triangular and rectangular cut-outs as well as EXTRA WIDTHS up to 1800 mm.</b>							

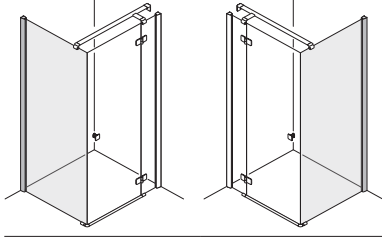
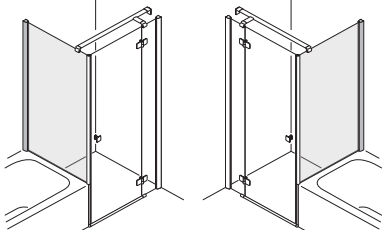

Hinge left	Hinge right	Height	Shower tray measurement (WM)	Shower tray installation measurement	Fixed part width Quantity stabilisers	Entrance width
<b>Side screen next to swinging door</b> 		<b>2000</b>	800	783 - 803	-	-
	900		883 - 903	-	-	
	1000		983 - 1003	-	-	
<b>CUSTOM MEASUREMENTS</b> - Measurement sketch needed. Height 1800 - 2200 mm. Shower tray installation measurement 200 - 1200 mm.						
<b>Surcharge for triangular and rectangular cut-outs as well as EXTRA WIDTHS up to 1800 mm.</b>						
<b>Shortened side screen</b> 					-	-
<b>CUSTOM MEASUREMENTS</b> - Measurement sketch needed. Height 1000 - 2200 mm. Shower tray installation measurement 200 - 1200 mm.						
<b>Surcharge for triangular and rectangular cut-outs as well as EXTRA WIDTHS up to 1800 mm.</b>						

**IMPORTANT**



• Required installation height is total height + 100 mm.



Art. no.		Colour		Glazing		Glass finishing (optional)	
P	R						

Base price

Surcharge

WM	left	right	MA High-gloss metal Matt aluminium	WP Matt white Graphite	EK Glass clear RW Strip Satin SA Satin	C ARTCLEAR GLAZING
			MP High-gloss metal Graphite	SP Matt black Graphite		ANNIVERSARY EDITION: ARTCLEAR GLAS including ARTSHOWER Softedge hand shower PLUS.
800	PR21 49	PR22 49	1,404	1,629	EK 0	211 + 
900	PR21 59	PR22 59			RW 259	
1000	PR21 69	PR22 69	1,476	1,701	SA 351	
1200	PR21 B9	PR22 B9	1,620	1,845		
	PR21 88	PR22 88	1,727	1,952		
			322	322		
800	PR31 49	PR32 49	1,466	1,691	EK 0	211 + 
900	PR31 59	PR32 59			RW 259	
1000	PR31 69	PR32 69	1,502	1,727	SA 351	
	PR31 88	PR32 88	1,727	1,952		
			322	322		

Artweger  
PROTECT

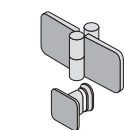

High-gloss metal  
Matt aluminium

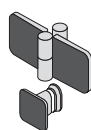

High-gloss metal  
Graphite



Matt white  
Graphite



Matt black  
Graphite



WM	left	right	MH High-gloss metal	WM Matt white SM Matt black	EK Glass clear RW Strip Satin SA Satin	C ARTCLEAR GLAZING
800	PR11 49	PR12 49	937	960	EK 0	211
900	PR11 59	PR12 59			RW 204	
1000	PR11 69	PR12 69	987	1,010	SA 351	
	PR11 88	PR12 88	1,141	1,164		
			322	322		
	PR61 88	PR62 88	1,043	1,066	EK 0	211
			322	322	RW 204 SA 351	

**IMPORTANT**

- When ordering please indicate assembly on shower tray or flush with floor.

# Anniversary Edition Artweger PRO:TECT Walk In

8 mm / Splashguard 6 mm ESG

ARTWEGER price list 03/2023. For specialised trade outlets only. Suggested retail prices in EUR not including VAT.  
DIMENSIONS IN MILLIMETRES.

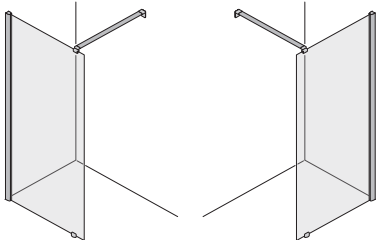
Installation left	Installation right	Height of glass	Width of glass	Overview of product features
		2000	303 - 1503	<ul style="list-style-type: none"> <li>• Wall bracket with 20 mm adjustment range.</li> <li>• Including stabiliser, length 1200 mm. Length has to be adjusted on site.</li> </ul>
<p><b>CUSTOM MEASUREMENTS</b> - Measurement sketch needed. Height of glass 700 - 2200 mm. Width of glass 300 - 1800 mm. <b>Surcharge for triangular and rectangular cut-outs.</b></p>				

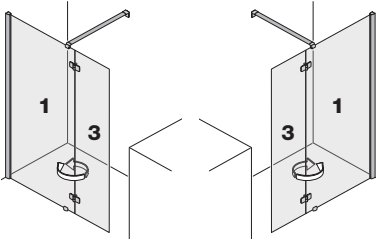

Installation left	Installation right	Height of glass	Width of glass	Overview of product features
		2000	<b>1</b> 303 - 1503 <b>3</b> 500	<ul style="list-style-type: none"> <li>• Wall bracket with 20 mm adjustment range.</li> <li>• <b>One mounted part and one 360° revolving glass part.</b></li> <li>• Suitable for smaller rooms.</li> <li>• <b>Only watertight when fully extended.</b></li> <li>• Including stabiliser, length 1200 mm. Length has to be adjusted on site.</li> </ul>
<p><b>CUSTOM MEASUREMENTS</b> - Measurement sketch needed. Height of glass 1800 - 2200 mm. Width of glass <b>1</b>: 300 - 1500 mm, <b>3</b>: 240 - 690 mm. <b>Surcharge for triangular and rectangular cut-outs.</b></p>				



## IMPORTANT

- Height of glass + 30 mm = total height incl. stabiliser. Required installation height is total height + 100 mm.
  - Stabiliser up to max. 1600 mm.
- Further custom sizes on request. Measurement sketch needed.
- Artweger Protect Walk In is individually custom adapted to the exact installation situation.

Art. no.		Colour		Glazing		Glass finishing (optional)	
P	R						
Base price				Surcharge			

left	right	MH High-gloss metal	WM Matt white SM Matt black	EK Glass clear RW Strip Satin SA Satin	C ARTCLEAR GLAZING  ANNIVERSARY EDITION: ARTCLEAR GLAS including ARTSHOWER Softedge hand shower PLUS.
PRW11 89	PRW12 89	1,611	1,836	EK 0 RW 204 SA 351	256 + 
PRW11 88	PRW12 88	1,773	1,998		
		322	322		



left	right	MA High-gloss metal Matt aluminium	WP Matt white Graphite	EK Glass clear RW Strip Satin SA Satin	C ARTCLEAR GLAZING  ANNIVERSARY EDITION: ARTCLEAR GLAS including ARTSHOWER Softedge hand shower PLUS.
PRWV1 89	PRWV2 89	2,304	2,529	EK 0 RW 250 SA 388	256 + 
PRWV1 88	PRWV2 88	2,467	2,692		
		322	322		



Artweger  
PROTECT

## EQUIPMENT OF THE ARTWEGER PROTECT Walk In

### Attachment to the wall

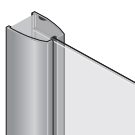

With wall profile.  
Adjustment of up to 20 mm  
(±10 mm) to allow for uneven or  
sloped walls.

### Connection to floor

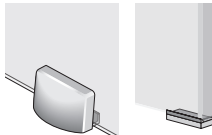

With adjustable foot  
or edge protector of  
transparent plastic.  
**Both variants are  
included.**

### Stabiliser

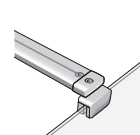

Horizontal stabilizer

## IMPORTANT

- Due to the open entrance area, watertightness cannot be obtained.
- When ordering please indicate assembly on shower tray or flush with floor. The total dimensions of the shower enclosure always refer to the outer edge of the glass. The fixation elements add to the overall dimensions. See page 9.

# Artweger WALK IN – overview

ARTWEGER price list 03/2023. For specialised trade outlets only. Suggested retail prices in EUR not including VAT.

## ARTWEGER 360 Walk In

- 8 mm ESG
- Partially framed or frameless design
- Custom heights, custom widths
- Triangular cut-outs, rectangular cut-outs
- **starting from page 80**

starting from  
EUR

**1,089**



## PROTECT Walk In

- 8 mm ESG
- **Mounting without drilling**
- Partially framed design
- Custom heights, custom widths
- Triangular cut-outs, rectangular cut-outs
- **starting from page 98**

starting from  
EUR

**1,611**



## Models especially for small rooms

with VARIO glass element



**ARTWEGER 360 Walk In**  
partially framed  
starting from EUR **1,628** page 82

**ARTWEGER 360 Walk In**  
frameless  
starting from EUR **2,151** page 86



**PROTECT Walk In**  
partially framed  
starting from EUR **2,304** page 98



**ZERO Walk In**  
partially framed  
starting from EUR **2,063** page 92

**ZERO Walk In BASIC**  
partially framed  
starting from EUR **1,648** page 94

# Artweger WALK IN – overview

ARTWEGER price list 03/2023. For specialised trade outlets only. Suggested retail prices in EUR not including VAT.

## DYNAMIC Walk In

- 6 mm or 8 mm ESG
- Partially framed design
- Custom widths
- **starting from page 100**

starting from  
EUR

**645**



## ZERO Walk In

- 8 mm ESG
- **Mounting without drilling**
- Silicone-free glass sealing
- Recessible U-profile 17 mm
- Custom heights, custom widths
- Triangular cut-outs, rectangular cut-outs
- **starting from page 88**

starting from  
EUR

**1,390**



## ZERO Walk In BASIC

- 8 mm ESG
- **Mounting without drilling**
- Silicone-free glass sealing
- U-profile 30 mm, adjustment range 15 mm
- No custom measurements
- **starting from page 94**

starting from  
EUR

**998**



Artweger  
WALK IN

as FREE-STANDING FOLDING DOOR



### ARTWEGER 360

partially framed  
starting from EUR **1,793** page 38

as SLIDING DOOR



### MOVE

with frame  
starting from EUR **1,386** page 138

### MOVE

frameless  
starting from EUR **1,735** page 142

# ARTWEGER 360 Walk In

Well-planned design

- Large model variety
- Barrier-free
- Optionally wall mounting profile or wall brackets
- Wall profile with 3D adjustment and concealed silicone joint
- Optional wall bracket inwards or outwards
- Safe glass supports with the option of adjustable foot or edge protection
- ARTWEGER 360 Walk In VARIO for small rooms
- 8 mm single-pane safety glass, (6 mm for free-standing double folding door attached on fixed part)
- Standard height 2000 mm
- Adjustment range 20 mm (models with wall profile)
- Customized solutions
- Custom sizes available



In the case of frameless models the transparent glass elements reach to the wall. Narrow brackets provide strong and safe stability.



ARTWEGER 360 Walk In VARIO:  
Makes modern shower solutions possible in small rooms. The moving element can be opened 180° inwards or outwards.



Accessories: Pivoting splashguard.  
Can also be retro-fitted.

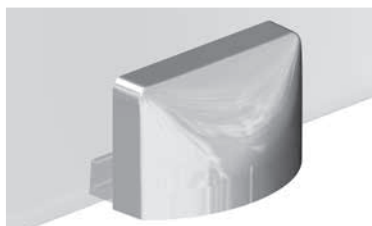

Adjustable feet prevent the glass from direct contact with the floor. This prevents damage to the glass and provides you with additional safety.



As an alternative to the adjustable feet a transparent edge protector can be installed.

Artweger®

artclear  
GLASS

CE

according to EN 14428

IMPORTANT

# ACCESSORIES

ARTWEGER price list 03/2023. For specialised trade outlets only.  
Suggested retail prices in EUR not including VAT. DIMENSIONS IN MILLIMETRES.

Art. no.				Colour	
9	0				
Base price					

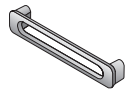

**Towel holder**  
For installation on tiled walls.

Width	Art. no.	VC Chrome WS White . . Additional colours
550	<b>900 11</b>	252

## EQUIPMENT OF THE ARTWEGER 360 Walk In

### Attachment to the wall

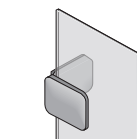

**FRAMELESS**  
Brackets  
inwards

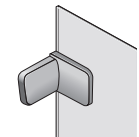

**FRAMELESS**  
Brackets  
outwards  
(optional)

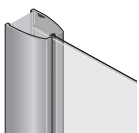

**PARTIALLY FRAMED**  
With wall profile.  
Adjustment of up to 20 mm  
(±10 mm) to allow for uneven or  
sloped walls.

### Connection to floor

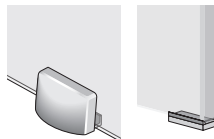

With adjustable foot  
or edge protector of  
transparent plastic.  
**Both variants are  
included.**

### Stabiliser

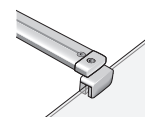

Horizontal stabilizer



Holding rod/ceiling  
support.  
Only article numbers  
9WA1 ../9WA2 ..  
9WTA1 ../9WTA2 ..

### IMPORTANT

- We will gladly send you the documents in hard copy on request.

# ARTWEGER 360 Walk In partially framed

ARTWEGER price list 03/2023. For specialised trade outlets only. Suggested retail prices in EUR not including VAT.  
DIMENSIONS IN MILLIMETRES.

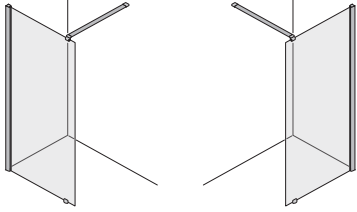
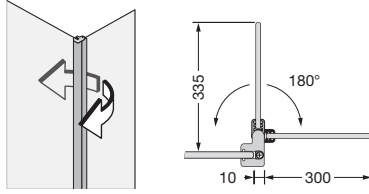
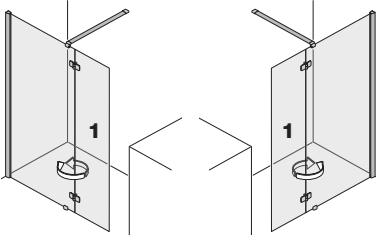
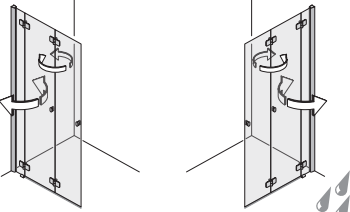
Installation left	Installation right	Height of glass	Shower tray measurement (WM)	Width of glass	Fixed part width Quantity stabilisers	Entrance width
<b>ARTWEGER 360 Walk In</b> without side screen  		<b>2000</b>	1000	980 - 1000	960 - 980 1	-
			1200	1180 - 1200	1160 - 1180 1	-
			1400	1380 - 1400	1360 - 1380 1	-
Including stabiliser, length 1200 mm. Length has to be adjusted on site. Version with rod fastened to ceiling. See page 84.						
<b>CUSTOM MEASUREMENTS</b> - Measurement sketch needed. Height of glass 700 - 2200 mm. Width of glass 300 - 1500 mm. <b>Surcharge for triangular and rectangular cut-outs as well as EXTRA WIDTHS up to 1800 mm.</b>						
<b>ARTWEGER 360 Walk In</b> Pivoting splashguard  		<b>2000</b>	300	<ul style="list-style-type: none"> <li>• <b>Accessories (optional)</b></li> <li>• <b>Can also be installed later.</b></li> <li>• Single-pane safety glass 6 mm</li> <li>• Can be mounted on the left or right.</li> </ul>		
<b>CUSTOM MEASUREMENTS</b> - Measurement sketch needed. Height 700 - 2000 mm. Width 200 - 500 mm. <b>Surcharge for triangular cut-outs.</b>						
<b>ARTWEGER 360 Walk In VARIO</b> without side screen  		<b>2000</b>	1300	1280 - 1300 ( <b>1</b> = 500)	760 - 780 1	-
			1400	1380 - 1400 ( <b>1</b> = 500)	860 - 880 1	-
			1500	1480 - 1500 ( <b>1</b> = 500)	960 - 980 1	-
Only watertight when fully extended. Including stabiliser, length 1200 mm. Length has to be adjusted on site.						
<b>CUSTOM MEASUREMENTS</b> - Measurement sketch needed. Height of glass 1800 - 2200 mm. Width of glass 300 - 1500 mm, <b>1</b> : 240 - 750 mm. <b>Surcharge for triangular and rectangular cut-outs.</b>						
<b>Double folding door</b> attached on fixed part free-standing  		<b>2000</b>	1000	980 - 1000	180 - 200 -	800
			1200	1180 - 1200	230 - 250 -	950
			1400	1380 - 1400	430 - 450 1	950
Execution without overflow moulding. Where the downward incline is insufficient or when mounting on a shower tray, a splash water bar is required for adequate protection. See page 37.						
<b>CUSTOM MEASUREMENTS</b> - Measurement sketch needed. Height 1800 - 2200 mm. Width 750 - 1800 mm. Folding doors max. 950 mm. One stabiliser included with fixed part widths 250 mm and wider.						

## IMPORTANT

- Height of glass + 30 mm = total height incl. stabiliser. Required installation height is total height + 100 mm.
  - Stabiliser up to max. 1600 mm.
- Further custom sizes on request. Measurement sketch needed.
- Due to the open entrance area, watertightness cannot be obtained.



Art. no.		Colour	Glazing	Glass finishing (optional)	Handle type	Colour	Handle/hinge
9							
Base price			Surcharge				
WM	left	right	MH High-gloss metal WS White . . Additional colours	EK Glass clear RW Strip Satin SA Satin	C ARTCLEAR GLAZING	K Knob	. . same as frame <sup>1</sup> VC Chrome
1000	9WT11 69	9WT12 69	1,089	EK 0			
1200	9WT11 B9	9WT12 B9	1,186	RW 204	256	-	-
1400	9WT11 E9	9WT12 E9	1,259	SA 351			
	9WT11 88	9WT12 88	1,624				
			322				
	9WL0 Z9		623	EK 0 RW - SA -	67	-	-
	9WL0 88		689				
			275				
1300	9WTV1 D9	9WTV2 D9	1,628	EK 0			
1400	9WTV1 E9	9WTV2 E9	1,674	RW 250	256	-	-
1500	9WTV1 H9	9WTV2 H9	1,719	SA 388			
	9WTV1 88	9WTV2 88	2,019				
			322				
1000	9TWT1 69	9TWT2 69	1,793	EK 0			
1200	9TWT1 B9	9TWT2 B9	1,861	RW 461	211	0	. . 0
1400	9TWT1 E9	9TWT2 E9	1,963	SA -			VC 0
	9TWT1 88	9TWT2 88	2,035				

Artweger  
WALK IN



## IMPORTANT

<sup>1</sup> Only VC chrome-plated available with MH high-gloss metal frames.

- When ordering please indicate assembly on shower tray or flush with floor. The total dimensions of the shower enclosure always refer to the outer edge of the glass. The fixation elements add to the overall dimensions. See page 9.

# ARTWEGER 360 Walk In partially framed

ARTWEGER price list 03/2023. For specialised trade outlets only. Suggested retail prices in EUR not including VAT.  
DIMENSIONS IN MILLIMETRES.

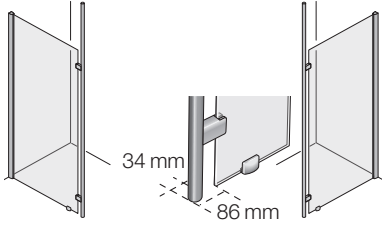
Installation left	Installation right	Height of glass	Width of glass	Overview of product features
<p><b>ARTWEGER 360 Walk In</b> with rod fastened to ceiling</p> 		<p><b>2000</b></p>	<p>300 - 1500</p>	<ul style="list-style-type: none"> <li>• Wall bracket with 20 mm adjustment range.</li> <li>• Overall width = measured on the outer edge of the holding bar.</li> <li>• With rod fastened to ceiling 2600 mm. Length has to be adjusted on site.</li> <li>• Attachment for the handrail to secure it to ceiling and floor.</li> </ul> <p><b>CUSTOM MEASUREMENTS</b> - Measurement sketch needed. Height of glass 700 - 2200 mm. Overall width 300 - 1500 mm.</p> <p><b>Surcharge for triangular and rectangular cut-outs as well as EXTRA WIDTHS up to 1800 mm.</b></p>

## IMPORTANT

- Further custom sizes on request. Measurement sketch needed.
- ARTWEGER 360 Walk In is individually custom adapted to the exact installation situation.

Art. no.		Colour	Glazing	Glass finishing (optional)
9	W			
Base price			Surcharge	

left	right	MH High-gloss metal	EK Glass clear RW Strip Satin SA Satin	C ARTCLEAR GLAZING
9WTA1 89	9WTA2 89	1,946	EK 0 RW 204 SA 351	256
9WTA1 88	9WTA2 88	2,111 322		

### IMPORTANT

- Due to the open entrance area, watertightness cannot be obtained.
- When ordering please indicate assembly on shower tray or flush with floor.

# ARTWEGER 360 Walk In frameless

ARTWEGER price list 03/2023. For specialised trade outlets only. Suggested retail prices in EUR not including VAT.  
DIMENSIONS IN MILLIMETRES.

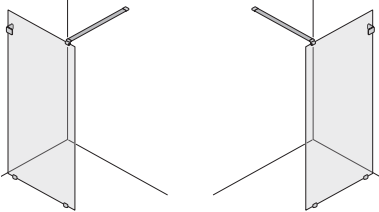
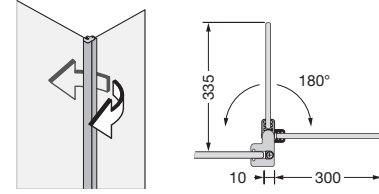
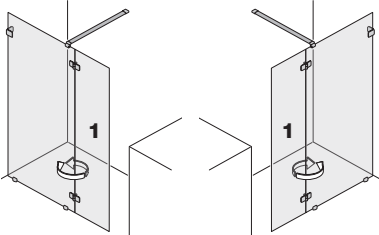
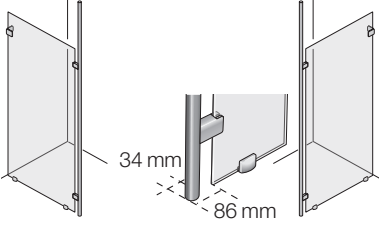
Installation left	Installation right	Height of glass	Width of glass	Overview of product features
<b>ARTWEGER 360 Walk In</b> without side screen 		2000	300 - 1500	<ul style="list-style-type: none"> <li>Including stabiliser, length 1200 mm. Length has to be adjusted on site.</li> </ul>
<b>CUSTOM MEASUREMENTS</b> - Measurement sketch needed. Height of glass 700 - 2200 mm. Width of glass 300 - 1500 mm. <b>Surcharge for triangular and rectangular cut-outs as well as EXTRA WIDTHS up to 1800 mm.</b>				
<b>ARTWEGER 360 Walk In</b> pivoting splashguard 		2000	300	<ul style="list-style-type: none"> <li><b>Accessories (optional)</b></li> <li><b>Can also be installed later.</b></li> <li>Single-pane safety glass 6 mm.</li> <li>Can be mounted on the left or right.</li> </ul>
<b>CUSTOM MEASUREMENTS</b> - Measurement sketch needed. Height 700 - 2000 mm. Width 200 - 500 mm. <b>Surcharge for triangular cut-outs.</b>				
<b>ARTWEGER 360 Walk In VARIO</b> without side screen 		2000	300 - 1500 (1 = 500)	<ul style="list-style-type: none"> <li><b>One mounted part and one 360° revolving glass part.</b></li> <li>Suitable for smaller rooms.</li> <li><b>Only watertight when fully extended.</b></li> <li>Including stabiliser, length 1200 mm. Length has to be adjusted on site.</li> </ul>
<b>CUSTOM MEASUREMENTS</b> - Measurement sketch needed. Height of glass 1800 - 2200 mm. Width of glass 300 - 1500 mm, <b>1</b> : 240 - 750 mm. <b>Surcharge for triangular and rectangular cut-outs.</b>				
<b>ARTWEGER 360 Walk In</b> with rod fastened to ceiling 		2000	300 - 1500	<ul style="list-style-type: none"> <li>Overall width = measured on the outer edge of the holding bar.</li> <li>With rod fastened to ceiling 2600 mm. Length has to be adjusted on site.</li> <li>Attachment for the handrail to secure it to ceiling and floor.</li> </ul>
<b>CUSTOM MEASUREMENTS</b> - Measurement sketch needed. Height of glass 700 - 2200 mm. Overall width 300 - 1500 mm. <b>Surcharge for triangular and rectangular cut-outs as well as EXTRA WIDTHS up to 1800 mm.</b>				

## IMPORTANT

- Height of glass + 30 mm = total height incl. stabiliser. Required installation height is total height + 100 mm.
  - Stabiliser up to max. 1600 mm.
- Further custom sizes on request. Measurement sketch needed.
- ARTWEGER 360 Walk In is individually custom adapted to the exact installation situation.

Art. no.		Colour	Glazing	Glass finishing (optional)	Brackets
9	W				
Base price			Surcharge		
left	right	VC Chrome WS White	EK Glass clear RW Strip Satin SA Satin	C ARTCLEAR GLAZING	I inwards A outwards
9W11 89	9W12 89	1,456	EK 0 RW 204 SA 351	256	I 0 A 0
9W11 88	9W12 88	1,619			
		275			
9WL0 Z9		623	EK 0 RW - SA -	67	-
9WL0 88		689			
		275			
9WV1 89	9WV2 89	2,151	EK 0 RW 250 SA 388	256	I 0 A 0
9WV1 88	9WV2 88	2,311			
		275			
9WA1 89	9WA2 89	VC 1,849 WS -	EK 0 RW 204 SA 351	256	I 0 A 0
9WA1 88	9WA2 88	2,010			
		275			

### IMPORTANT

- Due to the frameless construction and open entrance area, watertightness cannot be obtained.
- When ordering please indicate assembly on shower tray or flush with floor. The total dimensions of the shower enclosure always refer to the outer edge of the glass. The fixation elements add to the overall dimensions. See page 11.
- Correct installation is only possible if the floor is horizontal and the walls are vertical.

# Artweger ZERO Walk In

Less silicone. More perfection.

## • Mounting without drilling

- Barrier-free
- High quality seals replace silicone joints between glass and profile
- Depending on the type of installation it is possible to install without the use of any silicone at all
- Safe glass supports with transparent edge protection

- Mounting on the tiles or in the junction of the tiles
- Artweger ZERO VARIO for small rooms
- 8 mm single-pane safety glass
- Customized solutions
- Artweger Zero BASIC in standard height 2000 mm and fixed widths with an adjustment range of 15 mm



**Perfect appearance for many years:**  
High quality discreet seals replace the silicone joints.

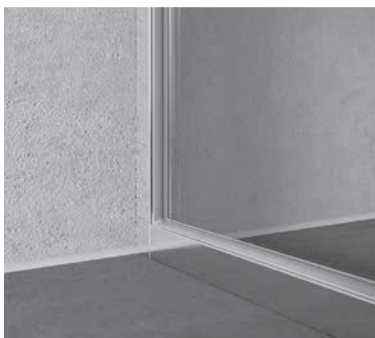

The wall profile is mounted ON the existing base surface.



**Mounting without drilling.**  
Quick and safe with adhesive technique.

**Le système de collage ART-FIX** is universally applicable for all substrates that are fully load-bearing, flat, dry, free of dust and grease, sealed against moisture and free of adhesion-reducing substances.



Artweger®

artclear  
GLASS

CE

according to EN 14428



**Can be freely combined:**  
The floor profile mounted ONTO the tiles, the wall profile integrated INTO the wall.



**100 % transparent:**  
The profiles are integrated INTO the wall and floor.

IMPORTANT

# Artweger ZERO Walk In Measurements for glass element

ARTWEGER price list 03/2023. For specialised trade outlets only.

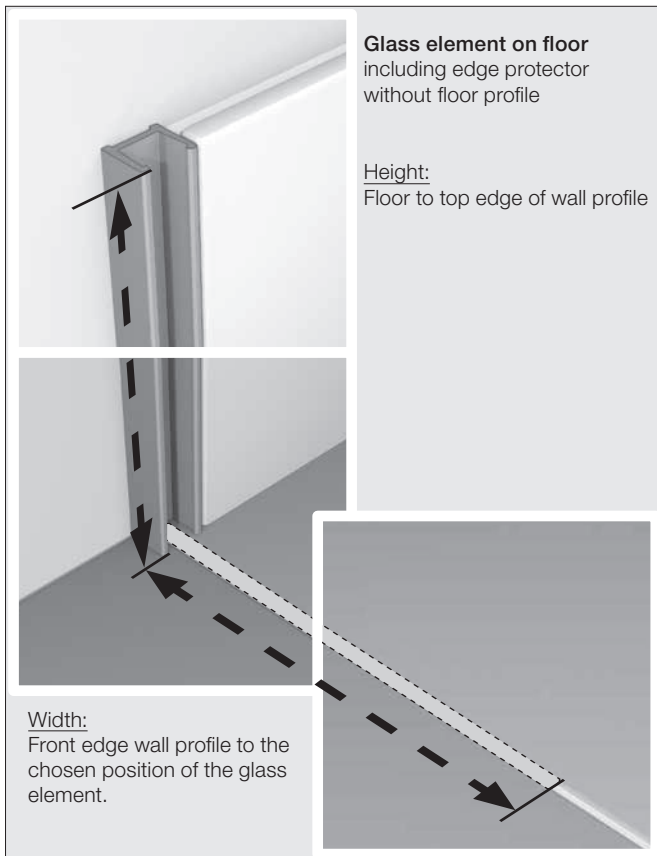
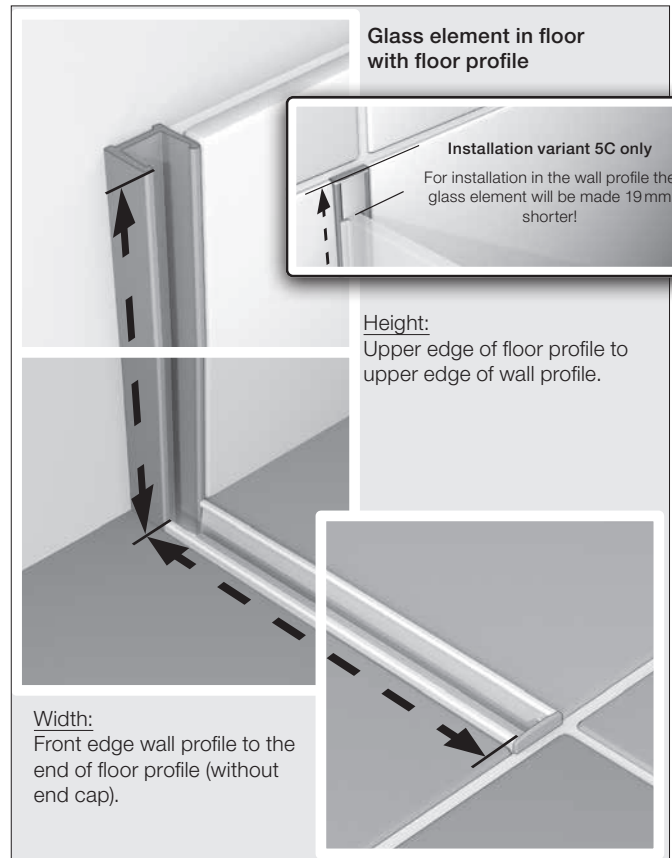
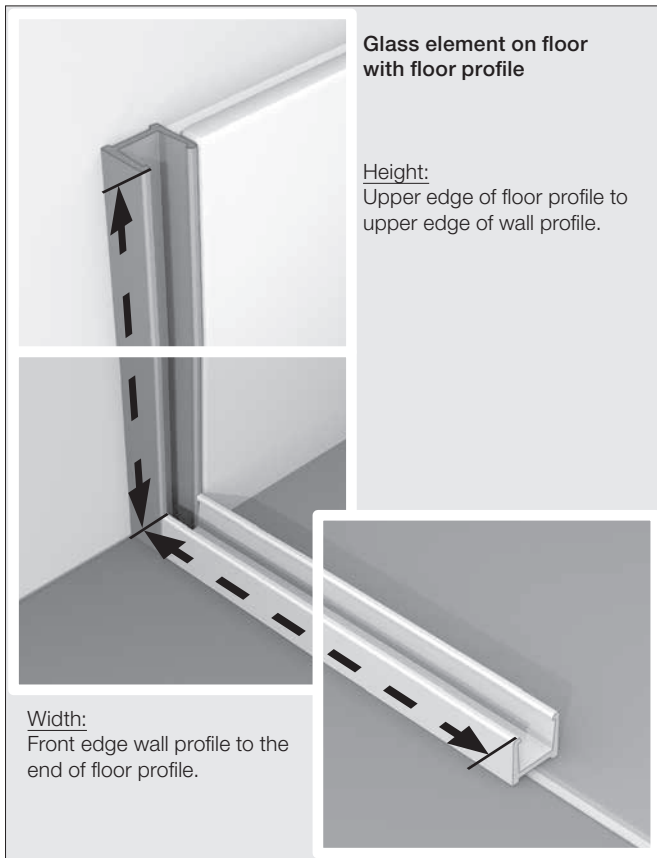

## For measurements please use only Artweger Zero Walk In measurement sheets.

You can find dimensions- and assembly- documents at: [www.artweger.at/aufmass](http://www.artweger.at/aufmass).

## Allowances in measurements for the glass elements in the wall and floor profiles are made at the factory.

The made to measure glass sheets are fitted into the mounting profiles and fixed using the sealant provided. No silicon needed.





Technical and safety data sheets for the high performance adhesive provided can be found under: [www.artweger.at/ZEROkleber](http://www.artweger.at/ZEROkleber)





### IMPORTANT

- We will gladly send you the documents in hard copy on request.

# Artweger ZERO Walk In INSTALLATION VERSIONS 1A - 5C

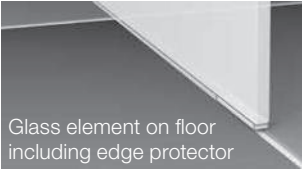
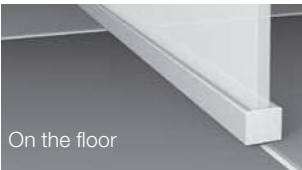
ARTWEGER price list 03/2023. For specialised trade outlets only. DIMENSIONS IN MILLIMETRES.

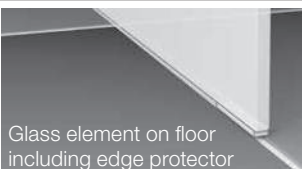
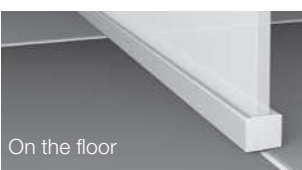
WALL PROFILE choose type of installation	
1	On the tiles 
2	Next to tiles 
3	Flush with tiled surface Profile upper edge flush with tile. 
4	Flush with tiled surface where there are tiles above the upper edge of the profile. 
5	Flush with tiled surface with covered mounting where there are tiles above the upper edge of the profile. 

FLOOR FIXATION choose type of installation	
A	 Glass element on floor including edge protector
B	 On the floor
C	 In floor
A	 Glass element on floor including edge protector
B	 On the floor
C	 In floor

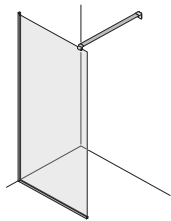
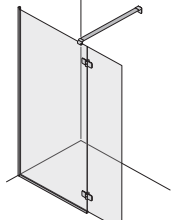
GLASS ELEMENT choose model
 ZERO Walk In
 ZERO Walk In VARIO

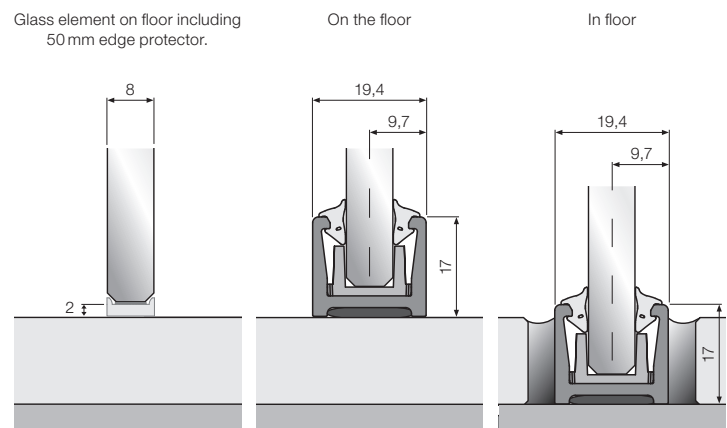
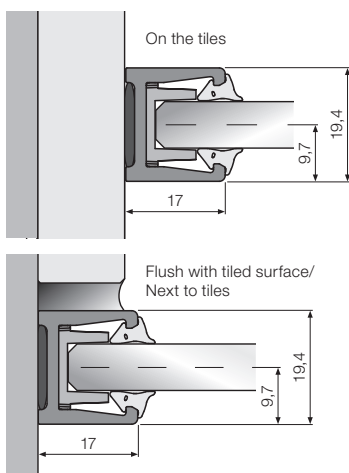

## IMPORTANT

- Tiles, ARTWALL wall panels and other wall coverings possible.
- Including transparent edge protection. The seal to the tiles to be made with silicon.



# RECOMMENDED ORDERING AND MOUNTING PROCEDURE

ARTWEGER price list 03/2023. For specialised trade outlets only.



	ORDER profile given	PRE-INSTALLATION profile given	MEASUREMENTS FOR	ORDER	FINAL ASSEMBLY
1 A	-	-	Glass element	Wall profile Glass element	Wall profile Glass element
1 B	-	-	Glass element	Wall profile Floor profile Glass element	Wall profile Floor profile Glass element
1 C	Wall profile Floor profile	Wall profile Floor profile	Glass element	Glass element	Glass element
2 A	Wall profile	Wall profile	Glass element	Glass element	Glass element
2 B	Wall profile Floor profile	Wall profile Floor profile	Glass element	Glass element	Glass element
2 C	Wall profile floor profile	Wall profile Floor profile	Glass element	Glass element	Glass element
3 A	Wall profile	Wall profile	Glass element	Glass element	Glass element
3 B	Wall profile Floor profile	Wall profile Floor profile	Glass element	Glass element	Glass element
3 C	Wall profile Floor profile	Wall profile Floor profile	Glass element	Glass element	Glass element
4 A	Wall profile	Wall profile	Glass element	Glass element	Glass element
4 B	Wall profile Floor profile	Wall profile Floor profile	Glass element	Glass element	Glass element
5 C	Wall profile Floor profile	Wall profile Floor profile	Glass element  For installation in the wall profile the glass element will be made 19 mm shorter!	Glass element	Glass element

Artweger  
WALK IN

## Artweger ZERO Walk In DESIGN RECOMMENDATION



- Wall profile flush with tiles
- Glass element on floor

= 3  
= A

installation version = 3 A

Components	Art. no.	Pieces	Prices in EUR
• Wall profile	RWP001 MH	1	184
• Glass element, left Height 2000 mm, width 1200 mm	RW11 89 MHEK	1	1,206
<b>Total price in EUR:</b>			<b>1,390</b>
High performance adhesive is included in the delivery.			

### IMPORTANT

- Wall and floor profiles can be cut to the required length on site. Therefore it is necessary to determine the measurements of the glass elements after the profiles are mounted according to each mounting situation.

# Artweger ZERO Walk In

8 mm ESG

ARTWEGER price list 03/2023. For specialised trade outlets only. Suggested retail prices in EUR not including VAT.  
DIMENSIONS IN MILLIMETRES.

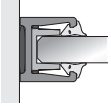
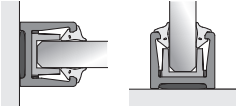
	Height/ length	Overview of product features
<b>Wall profile</b> installation versions 1A, 2A, 3A, 4A 	2200	<ul style="list-style-type: none"> <li>• Including high performance adhesive. Suitable for use on tiles, concrete, plaster, plasterboard, gypsum fiber plate, wood and metal as well as all standard shower trays.</li> <li>• When mounting flush with tiles or in the floor, bonding is on the sealant</li> <li>• Drilling the wall is not necessary.</li> <li>• The exact fitting of the profiles is carried out at the installation site.</li> <li>• <b>The installation profile is permanently fixed to the wall and floor with a rapid-curing, high performance adhesive that also acts as a sealant (also for corner profile joints).</b></li> <li>• High performance hybrid adhesive: The top quality adhesive can be used on various surfaces and complies with the requirements of IVD guideline sheet number 30 for adhesives and sealants For detailed information see <a href="http://www.artweger.at/ZEROkleber">www.artweger.at/ZEROkleber</a>.</li> </ul>
<b>Wall profile + floor profile</b> installation versions 1B, 1C, 2B, 2C, 3B, 3C, 4B, 5C 	2200	

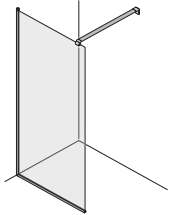
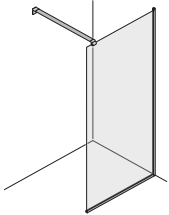
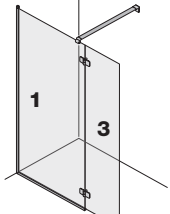
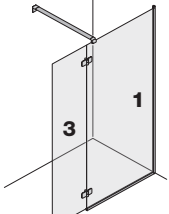
Installation left	Installation right	Height	Width	Overview of product features
		1900 - 2050	300 - 1400	<ul style="list-style-type: none"> <li>• Including stabiliser, length 1200 mm. Length has to be adjusted on site.</li> <li>• Including sealant for wall or floor profile</li> <li>• <b>Please order profiles extra.</b></li> </ul>
<b>CUSTOM MEASUREMENTS</b> - Measurement sketch needed. Height of glass 1600 - 2200 mm. Width of glass 300 - 1500 mm.				
<b>Surcharge for triangular and rectangular cut-outs as well as EXTRA WIDTHS up to 1800 mm.</b>				
		1900 - 2050	<b>1</b> 550 - 1300 <b>3</b> 300 - 500	<ul style="list-style-type: none"> <li>• <b>One mounted part and one 360° revolving glass part.</b></li> <li>• Suitable for smaller rooms.</li> <li>• <b>Only watertight when fully extended.</b></li> <li>• Including stabiliser, length 1200 mm. Length has to be adjusted on site.</li> <li>• Including sealant for wall or floor profile</li> <li>• <b>Please order profiles extra.</b></li> </ul>
<b>CUSTOM MEASUREMENTS</b> - Measurement sketch needed. Height of glass 1600 - 2200 mm. Width of glass <b>1</b> : 550 - 1500 mm, <b>3</b> : 300 - 750 mm.				
<b>Surcharge for triangular and rectangular cut-outs as well as EXTRA WIDTHS up to 1800 mm.</b>				

## IMPORTANT

- Height of glass + 30 mm = total height incl. stabiliser. Required installation height is total height + 100 mm.
  - Width over 1600 mm on request. Stabiliser up to max. 1600 mm.
  - Further custom sizes on request. Measurement sketch needed.
- Artweger Zero Walk In is individually custom adapted to the exact installation situation. Production can only take place upon presentation of an exact sketch with measurements.

Art. no.		Colour	
R	W		
Base price			

Art. no.	MH High-gloss metal
RWP001	184
RWP002	299

Art. no.		Colour	Glazing	Glass finishing (optional)
R	W			
Base price		Surcharge		

left	right	MH High-gloss metal	EK Glass clear RW Strip Satin SA Satin	C ARTCLEAR GLAZING
RW11 89	RW12 89	1,206	EK 0 RW 204 SA 351	256
RW11 88	RW12 88	1,362		
		267		
RWV1 89	RWV2 89	1,879	EK 0 RW 250 SA 388	256
RWV1 88	RWV2 88	2,034		
		267		

### IMPORTANT

- Due to the open entrance area, watertightness cannot be obtained.
- When ordering please indicate assembly on shower tray or flush with floor.  
The total dimensions of the shower enclosure always refer to the outer edge of the glass. The fixation elements add to the overall dimensions. See page 90.
- Correct installation is only possible if the floor is horizontal and the walls are vertical.

# Artweger ZERO Walk In BASIC

8 mm ESG

ARTWEGER price list 03/2023. For specialised trade outlets only. Suggested retail prices in EUR not including VAT.  
DIMENSIONS IN MILLIMETRES.

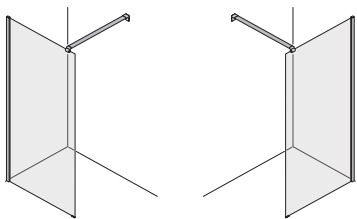
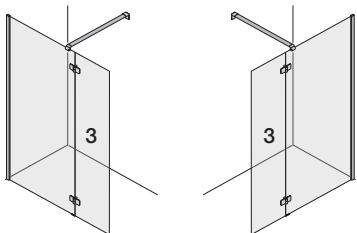
Installation left	Installation right	Height	Shower tray installation measurement	Width of glass	Overview of product features
<b>ZERO Walk In BASIC</b>		<b>2000</b>	785 - 800	765 - 780	<ul style="list-style-type: none"> <li>• Including high performance adhesive.</li> <li>• Including stabiliser, length 1200 mm. Length has to be adjusted on site.</li> </ul>
			885 - 900	865 - 880	
			985 - 1000	965 - 980	
			1085 - 1100	1065 - 1080	
			1185 - 1200	1165 - 1180	
			1285 - 1300	1265 - 1280	
			1385 - 1400	1365 - 1380	
<b>CUSTOM MEASUREMENTS - Not available.</b>					
<b>ZERO Walk In BASIC VARIO</b>		<b>2000</b>	1285 - 1300	1265 - 1280	<ul style="list-style-type: none"> <li>• <b>One mounted part and one 360° revolving glass part.</b></li> <li>• Suitable for smaller rooms.</li> <li>• <b>Only watertight when fully extended.</b></li> <li>• Including high performance adhesive.</li> <li>• Including stabiliser, length 1200 mm. Length has to be adjusted on site.</li> </ul>
			1385 - 1400	1365 - 1380	
			1485 - 1500	1465 - 1480	
			1585 - 1600	1565 - 1580	
			1685 - 1700	1665 - 1680	
				<b>3 = 500</b>	
<b>CUSTOM MEASUREMENTS - Not available.</b>					

The installation profile is permanently fixed to the wall with a rapid-curing, high performance adhesive that also acts as a sealant.

High performance hybrid adhesive: The top quality adhesive can be used on various surfaces and complies with the requirements of IVD guideline sheet number 30 for adhesives and sealants

## Equipment of the ZERO Walk In BASIC

### Attachment to the wall ZERO BASIC

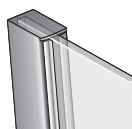

Wall bracket with 15 mm adjustment range.

### Connection to floor ZERO BASIC



With edge protector of transparent plastic.

### Stabiliser ZERO BASIC

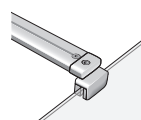

Horizontal stabilizer

## IMPORTANT

- Height + 30 mm = total height incl. stabiliser. Required installation height is total height + 100 mm.
- Due to the open entrance area, watertightness cannot be obtained.

Art. no.	Colour	Glazing	Glass finishing (optional)
RW			
Base price		Surcharge	

WM	left	right	MH High-gloss metal . . Additional colours	EK Glass clear	C ARTCLEAR GLAZING
785 - 800	<b>RWB0 49</b>		998		
885 - 900	<b>RWB0 59</b>		1,031		
985 - 1000	<b>RWB0 69</b>		1,064		
1085 - 1100	<b>RWB0 09</b>		1,095	0	256
1185 - 1200	<b>RWB0 B9</b>		1,131		
1285 - 1300	<b>RWB0 D9</b>		1,166		
1385 - 1400	<b>RWB0 E9</b>		1,196		
1285 - 1300	<b>RWC1 D9</b>	<b>RWC2 D9</b>	1,648		
1385 - 1400	<b>RWC1 E9</b>	<b>RWC2 E9</b>	1,675		
1485 - 1500	<b>RWC1 H9</b>	<b>RWC2 H9</b>	1,705	0	256
1585 - 1600	<b>RWC1 K9</b>	<b>RWC2 K9</b>	1,735		
1685 - 1700	<b>RWC1 M9</b>	<b>RWC2 M9</b>	1,762		

## IMPORTANT

- When ordering please indicate assembly on shower tray or flush with floor. The total dimensions of the shower enclosure always refer to the outer edge of the glass. The fixation elements add to the overall dimensions. See page 10.
- Correct installation is only possible if the floor is horizontal and the walls are vertical.

# Anniversary Edition PRO:TECT Walk In

# DYNAMIC Walk In

## • Mounting without drilling

- Barrier-free
- Wall profile with 3D adjustment
- 8 mm single-pane safety glass
- Standard height 2000 mm
- Adjustment range 20 mm
- Custom sizes available

## • Barrier-free

- Safe glass supports with edge protection
- 6 mm and 8 mm single-pane safety glass
- Standard height 2000 mm
- Adjustment range 15 mm
- Custom widths available



**Mounting without drilling.**  
Quick and safe with adhesive technique.

**Le système de collage ART-FIX** is universally applicable for all substrates that are fully load-bearing, flat, dry, free of dust and grease, sealed against moisture and free of adhesion-reducing substances.

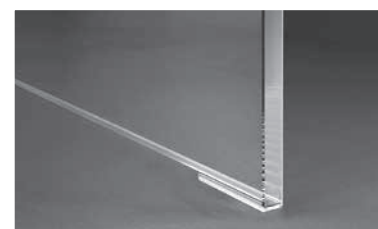

The floor support is made without a profile with a transparent edge protector.

**Artweger**



according to EN 14428

**IMPORTANT**

# MOVE Walk In

- Barrier free entry
- 6 mm single-pane safety glass
- Standard height 2000 mm
- Framed models including a 20 mm adjustment range
- Frameless models made to measure according to requirements
- Custom sizes available



With SOFT OPEN / SOFT CLOSE (optional) the most up to date technology is hidden behind the elegant inside panel. The door is gently slowed down just before the end and then glides smoothly into the stop position.



The patent pending magnetic closure enables the door to swing open by lightly pressing it. This makes cleaning much easier.

Artweger  
WALK IN

## ACCESSORIES

ARTWEGER price list 03/2023. For specialised trade outlets only.  
Suggested retail prices in EUR not including VAT. DIMENSIONS IN MILLIMETRES.

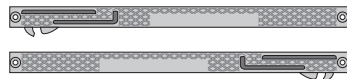

**Comfort system SOFT OPEN/SOFT CLOSE**  
Upgrade for existing Artweger MOVE sliding doors.

Art. no.
M 0 1 1 1
Base price

Art. no.	Base price
M0001	141

Artweger®

artclear  
GLASS

CE

according to EN 14428

### IMPORTANT

- We will gladly send you the documents in hard copy on request.

# Anniversary Edition Artweger PRO:TECT Walk In

8 mm / Splashguard 6 mm ESG

ARTWEGER price list 03/2023. For specialised trade outlets only. Suggested retail prices in EUR not including VAT.  
DIMENSIONS IN MILLIMETRES.

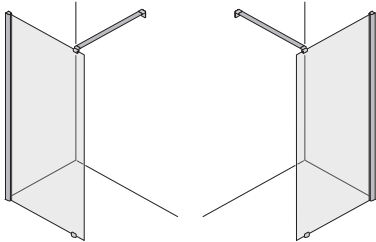
Installation left	Installation right	Height of glass	Width of glass	Overview of product features
		2000	303 - 1503	<ul style="list-style-type: none"> <li>• Wall bracket with 20 mm adjustment range.</li> <li>• Including stabiliser, length 1200 mm. Length has to be adjusted on site.</li> </ul>
<p><b>CUSTOM MEASUREMENTS</b> - Measurement sketch needed. Height of glass 700 - 2200 mm. Width of glass 300 - 1800 mm. <b>Surcharge for triangular and rectangular cut-outs.</b></p>				

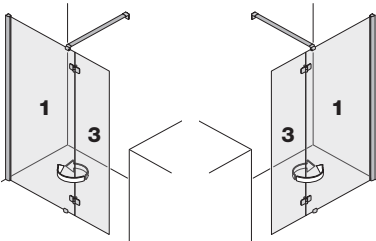

Installation left	Installation right	Height of glass	Width of glass	Overview of product features
		2000	<b>1</b> 303 - 1503 <b>3</b> 500	<ul style="list-style-type: none"> <li>• Wall bracket with 20 mm adjustment range.</li> <li>• <b>One mounted part and one 360° revolving glass part.</b></li> <li>• Suitable for smaller rooms.</li> <li>• <b>Only watertight when fully extended.</b></li> <li>• Including stabiliser, length 1200 mm. Length has to be adjusted on site.</li> </ul>
<p><b>CUSTOM MEASUREMENTS</b> - Measurement sketch needed. Height of glass 1800 - 2200 mm. Width of glass <b>1</b>: 300 - 1500 mm, <b>3</b>: 240 - 690 mm. <b>Surcharge for triangular and rectangular cut-outs.</b></p>				



## IMPORTANT

- Height of glass + 30 mm = total height incl. stabiliser. Required installation height is total height + 100 mm.
  - Stabiliser up to max. 1600 mm.
- Further custom sizes on request. Measurement sketch needed.
- Artweger Protect Walk In is individually custom adapted to the exact installation situation.



Art. no.		Colour		Glazing		Glass finishing (optional)	
P	R						
Base price				Surcharge			

left	right	MH High-gloss metal	WM Matt white SM Matt black	EK Glass clear RW Strip Satin SA Satin	C ARTCLEAR GLAZING  ANNIVERSARY EDITION: ARTCLEAR GLAS including ARTSHOWER Softedge hand shower PLUS.
PRW11 89	PRW12 89	1,611	1,836	EK 0 RW 204 SA 351	256 + 
PRW11 88	PRW12 88	1,773	1,998		
		322	322		



left	right	MA High-gloss metal Matt aluminium	WP Matt white Graphite	EK Glass clear RW Strip Satin SA Satin	C ARTCLEAR GLAZING  ANNIVERSARY EDITION: ARTCLEAR GLAS including ARTSHOWER Softedge hand shower PLUS.
PRWV1 89	PRWV2 89	2,304	2,529	EK 0 RW 250 SA 388	256 + 
PRWV1 88	PRWV2 88	2,467	2,692		
		322	322		



Artweger  
WALK IN

## EQUIPMENT OF THE ARTWEGER PROTECT Walk In

### Attachment to the wall

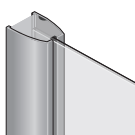

With wall profile.  
Adjustment of up to 20 mm  
(±10 mm) to allow for uneven or  
sloped walls.

### Connection to floor

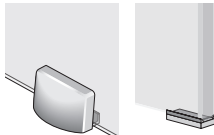

With adjustable foot  
or edge protector of  
transparent plastic.  
**Both variants are  
included.**

### Stabiliser

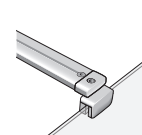

Horizontal stabilizer

## IMPORTANT

- Due to the open entrance area, watertightness cannot be obtained.
- When ordering please indicate assembly on shower tray or flush with floor. The total dimensions of the shower enclosure always refer to the outer edge of the glass. The fixation elements add to the overall dimensions. See page 9.

# Artweger DYNAMIC Walk In

6 mm ESG  
8 mm ESG

ARTWEGER price list 03/2023. For specialised trade outlets only. Suggested retail prices in EUR not including VAT.  
DIMENSIONS IN MILLIMETRES.

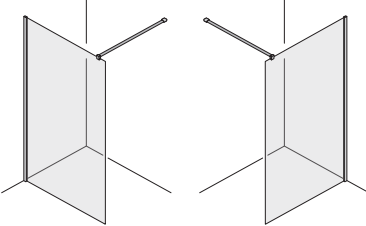
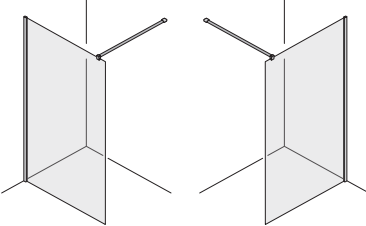
Installation left	Installation right	Height	Shower tray measurement (WM) length a x width b	Shower tray installation measurement	Fixed part width Quantity stabilisers	Entrance width
<b>DYNAMIC Walk In 6 mm ESG</b>		<b>2000</b>	800	785 - 800	765 - 780	1 -
			900	885 - 900	865 - 880	1 -
			1000	985 - 1000	965 - 980	1 -
			1100	1085 - 1100	1065 - 1080	1 -
			1200	1185 - 1200	1165 - 1180	1 -
			1300	1285 - 1300	1265 - 1280	1 -
			1400	1385 - 1400	1365 - 1380	1 -
Including stabiliser, length 1200 mm. Length has to be adjusted on site.						
<b>CUSTOM WIDTH</b> - Measurement sketch needed. Shower tray installation measurement 500 - 1400 mm. Custom heights not available.						
<b>DYNAMIC Walk In 8 mm ESG</b>		<b>2000</b>	800	785 - 800	765 - 780	1 -
			900	885 - 900	865 - 880	1 -
			1000	985 - 1000	965 - 980	1 -
			1100	1085 - 1100	1065 - 1080	1 -
			1200	1185 - 1200	1165 - 1180	1 -
			1300	1285 - 1300	1265 - 1280	1 -
			1400	1385 - 1400	1365 - 1380	1 -
Including stabiliser, length 1200 mm. Length has to be adjusted on site.						
<b>CUSTOM WIDTH</b> - Measurement sketch needed. Shower tray installation measurement 500 - 1400 mm. Custom heights not available.						

## IMPORTANT

- Required installation height is total height + 100 mm.
- When ordering please indicate assembly on shower tray or flush with floor.

Art. no.	Frame colour	Glazing	Glass finishing (optional)
6			
Base price		Surcharge	

WM	Art. no.	MH High-gloss metal	EK Glass clear	C ARTCLEAR GLAZING
800	<b>6W0 49</b>	645		
900	<b>6W0 59</b>	663		
1000	<b>6W0 69</b>	680		
1100	<b>6W0 09</b>	698	0	256
1200	<b>6W0 B9</b>	717		
1300	<b>6W0 D9</b>	735		
1400	<b>6W0 E9</b>	754		
	<b>6W0 89</b>	850		
800	<b>6WA 49</b>	827		
900	<b>6WA 59</b>	843		
1000	<b>6WA 69</b>	860		
1100	<b>6WA 09</b>	878	0	256
1200	<b>6WA B9</b>	896		
1300	<b>6WA D9</b>	922		
1400	<b>6WA E9</b>	950		
	<b>6WA 89</b>	1,073		

# Artweger MOVE Walk In

6 mm ESG

ARTWEGER price list 03/2023. For specialised trade outlets only. Suggested retail prices in EUR not including VAT.  
DIMENSIONS IN MILLIMETRES.

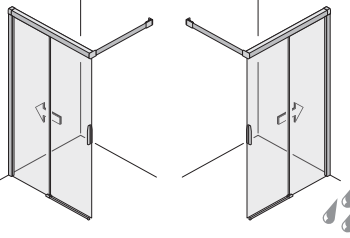
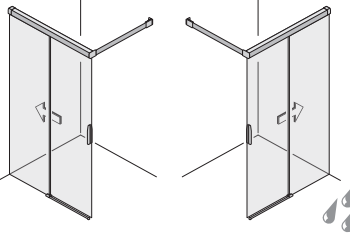
Fixed part left	Fixed part right	Height	Shower tray measurement (WM)	Width	Fixed part width	Entrance width
<b>MOVE Double sliding door Walk In with frame</b> 		<b>2000</b>	1000	970 - 990	457 - 477	-
1 door part and 1 fixed part			1100	1070 - 1090	512 - 532	-
			1200	1170 - 1190	557 - 577	-
			1400	1370 - 1390	657 - 677	-
			1600	1570 - 1590	757 - 777	-
		Incl. stabiliser, length 1250 mm. Length has to be adjusted on site.			<b>CUSTOM MEASUREMENTS</b> - Measurement sketch needed. Height 1800 - 2200 mm. Shower tray installation measurement 1000 - 1600 mm.	
<b>MOVE Double sliding door Walk In frameless</b> 		<b>2000</b>	1000 - 1200	According to dimension sketch. Incl. stabiliser, length 1250 mm. Length has to be adjusted on site.		
1 door part and 1 fixed part			1201 - 1400			
			1401 - 1600			
		<b>CUSTOM MEASUREMENTS</b> - Measurement sketch needed. Height 1800 - 2200 mm. Shower tray installation measurement 1000 - 1600 mm.				

**IMPORTANT**

- Required installation height is total height + 100 mm.

Art. no.		Frame colour			Glazing		Glass finishing (optional)	Comfort system
M								
Base price					Surcharge			
left	right	MH High-gloss metal	WS White SM Matt black LB Silver	WM Matt white GF Graphite metallic CN Champagne MK Mokka BZ Bronze . . Additional colours	EK Glass clear RW Strip Satin SA Satin	C ARTCLEAR GLAZING	S SOFT OPEN SOFT CLOSE	
MGF1 69	MGF2 69	1,386	1,611	1,846	EK 0 RW 259 SA 388	256	116	
MGF1 09	MGF2 09	1,416	1,641	1,876				
MGF1 B9	MGF2 B9	1,447	1,672	1,907				
MGF1 E9	MGF2 E9	1,505	1,730	1,965				
MGF1 K9	MGF2 K9	1,568	1,793	2,028				
MGF1 88	MGF2 88	1,611	1,836	2,071				
MRF1 B9	MRF2 B9	1,735	1,960	2,195	EK 0 RW 259 SA 388	256	116	
MRF1 E9	MRF2 E9	1,807	2,032	2,267				
MRF1 K9	MRF2 K9	1,882	2,107	2,342				
MRF1 88	MRF2 88	1,933	2,158	2,393				

### IMPORTANT

- When ordering please indicate assembly on shower tray or flush with floor.

# TWISTLINE

Twist more space into the bathroom.

- Rotating-cylinder swing doors with or without fixed doors
- Swinging door can be opened 90° outwards as well as inwards
- Barrier-free with Vario sealing system
- Raise and lower mechanism
- Wall profile with 3D adjustment and concealed silicone joints in models with fixed parts
- 6 mm single-pane safety glass
- Standard height 1900 mm or 2040 mm
- Adjustment range 18 mm
- Custom sizes available



With swinging doors which can be opened inwards as well as outwards.



The RAISE-LOWER hinge provides simple opening and closing of the doors. When opening, the swinging door is raised gently. When closed, the door is lowered again.



LOVELY COMBINATION:  
Elegant straight handle on the outside and a knob inside. Colour chrome.



Artweger®

artclear  
GLASS

CE

according to EN 14428



VARIO sealing system:  
You decide either for 100 %  
FLUSH-TO-FLOOR ACCESS or ...



... for an optional surge bar which  
is only 10 mm high and provides  
IMPROVED SEALING of the door.

IMPORTANT

# ACCESSORIES

ARTWEGER price list 03/2023. For specialised trade outlets only.  
Suggested retail prices in EUR not including VAT. DIMENSIONS IN MILLIMETRES.

Art. no.				Colour	
5	T				
Base price					

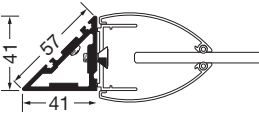
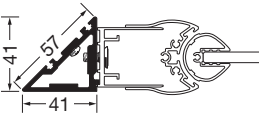
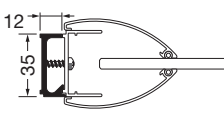
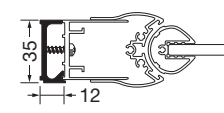
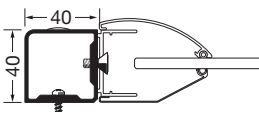
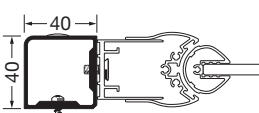
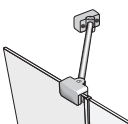
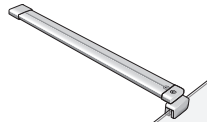
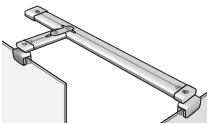
	Height / length	Art. no.	MH High-gloss metal	WS White
 <p><b>Mounting bracket, 45°</b> For installation on tiled walls under 45°. Required additional information: article number of the respective shower enclosure.</p>	2040	<b>5T0P 7H</b>	259	290
	1900	<b>5T0P 77</b>	253	283
	Custom size	<b>5T0P 78</b>	310	347
 <p><b>Mounting bracket, 45° for swinging doors without fixed part.</b> For installation on tiled walls under 45°. Necessary additional information: article number of the respective shower enclosure.</p>	2040	<b>5T0P 9H</b>	259	290
	1900	<b>5T0P 97</b>	253	283
	Custom size	<b>5T0P 98</b>	310	347
 <p><b>Compound bracket 12 mm for side screen and swinging doors attached on fixed part.</b> Extends adjustment range by 12 mm. Required additional information: article number of the respective shower enclosure.</p>	2040	<b>5T0P 3H</b>	124	139
	1900	<b>5T0P 37</b>	122	137
	Custom size	<b>5T0P 38</b>	147	165
 <p><b>Compound bracket 12 mm for swinging doors without fixed part.</b> Extends adjustment range by 12 mm. Required additional information: article number of the respective shower enclosure.</p>	2040	<b>5T0P 5H</b>	124	139
	1900	<b>5T0P 57</b>	122	137
	Custom size	<b>5T0P 58</b>	147	165
 <p><b>Mounting bracket</b> For attaching to wall projections. Required additional information: article number of the respective shower enclosure.</p>	2040	<b>5T0P 1H</b>	259	290
	1900	<b>5T0P 17</b>	253	283
	Custom size	<b>5T0P 18</b>	310	347
 <p><b>Mounting bracket for swinging doors without fixed part.</b> For attaching to wall projections. Necessary additional information: article number of the respective shower enclosure.</p>	2040	<b>5T0P 2H</b>	259	290
	1900	<b>5T0P 27</b>	253	283
	Custom size	<b>5T0P 28</b>	310	347
 <p><b>Stabiliser</b> Fits quarter-round and pentagonal shower, doors and corner entry.</p>	ca. 300	<b>5T00 31</b>	142	163
	ca. 430	<b>5T00 32</b>	155	178
 <p><b>Side-screen stabiliser</b> Length has to be adjusted on site.</p>	ca. 1200	<b>5T00 34</b>	165	190
 <p><b>T-Stabilizer</b> Length has to be adjusted on site.</p>	ca. 1200	<b>5T00 36</b>	222	255

TWISTLINE

LEFT/RIGHT in the case of an asymmetric shower tray

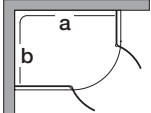
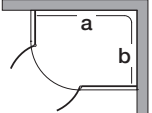
LEFT		RIGHT
5TR1AH 5TR1GH 5TR1A7 5TR1G7		
		5TR2AH 5TR2GH 5TR2A7 5TR2G7

## IMPORTANT

- We will gladly send you the documents in hard copy on request.

# TWISTLINE

Swinging door 6 mm ESG

ARTWEGER price list 03/2023. For specialised trade outlets only. Suggested retail prices in EUR not including VAT.  
DIMENSIONS IN MILLIMETRES.

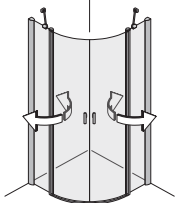
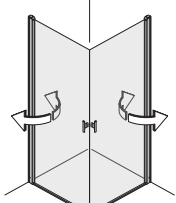
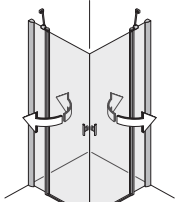
	Height	Shower tray measurement (WM) length a x width b	Shower tray installation measurement	Fixed part width Quantity stabilisers	Entrance width	
<b>1/4-round shower</b>    2 swinging doors and 2 fixed parts	<b>2040</b>	<b>800 x 800 I</b> R=500	782 - 800	260 - 280    2	670	
		<b>900 x 900 II</b> R=550	882 - 900	310 - 330    2	740	
		<b>1000 x 1000 II</b> R=550	982 - 1000	410 - 430    2	740	
		<b>900 x 800 I</b> R=500	882 - 900 x 782 - 800	360 - 380 x 260 - 280    2	670	
		<b>1200 x 900 II</b> R=550	1182 - 1200 x 882 - 900	610 - 630 x 310 - 330    2	740	
	<b>1900</b>	<b>800 x 800 I</b> R=500	782 - 800	260 - 280    2	670	
		<b>900 x 900 II</b> R=550	882 - 900	310 - 330    2	740	
		<b>1000 x 1000 II</b> R=550	982 - 1000	410 - 430    2	740	
		<b>900 x 800 I</b> R=500	882 - 900 x 782 - 800	360 - 380 x 260 - 280    2	670	
		<b>1200 x 900 II</b> R=550	1182 - 1200 x 882 - 900	610 - 630 x 310 - 330    2	740	
<b>CUSTOM MEASUREMENTS</b> - Measurement sketch needed. fixed-part custom width (narrower or wider). Width max. 1200 x 1200 mm. Custom heights not available. <b>Surcharge for triangular and rectangular cut-outs.</b>						
<b>Corner entry</b>    2 swinging doors	<b>2040</b>	<b>800 x 800</b>	782 - 800	-    -	970	
		<b>900 x 900</b>	882 - 900	-    -	1120	
		<b>900 x 750</b> left    right	882 - 900 x 732 - 750	-    -	1020	
		<b>750 x 900</b>	732 - 750 x 882 - 900	-    -	1020	
		<b>900 x 800</b>	882 - 900 x 782 - 800	-    -	1050	
		<b>800 x 900</b>	782 - 800 x 882 - 900	-    -	1050	
	<b>1900</b>	<b>800 x 800</b>	782 - 800	-    -	970	
		<b>900 x 900</b>	882 - 900	-    -	1120	
		<b>900 x 750</b> left    right	882 - 900 x 732 - 750	-    -	1020	
		<b>750 x 900</b>	732 - 750 x 882 - 900	-    -	1020	
		<b>900 x 800</b>	882 - 900 x 782 - 800	-    -	1050	
		<b>800 x 900</b>	782 - 800 x 882 - 900	-    -	1050	
	<b>CUSTOM MEASUREMENTS</b> - Measurement sketch needed. Height 1500 - 2100 mm. Shower tray installation measurement 700 - 1000 mm. Price for combination of custom and standard measurement: (custom price + standard price) / 2.					
<b>Corner entry attached on fixed part</b>    2 swinging doors and 2 fixed parts	<b>2040</b>	<b>800 x 800</b>	782 - 800	220 - 240    -	750	
		<b>900 x 900</b>	882 - 900	270 - 290    -	820	
		<b>1000 x 1000</b>	982 - 1000	370 - 390    2	820	
		<b>1200 x 1200</b>	1182 - 1200	470 - 490    2	960	
	<b>1900</b>	<b>800 x 800</b>	782 - 800	220 - 240    -	750	
		<b>900 x 900</b>	882 - 900	270 - 290    -	820	
		<b>1000 x 1000</b>	982 - 1000	370 - 390    2	820	
		<b>1200 x 1200</b>	1182 - 1200	470 - 490    2	960	
	<b>CUSTOM MEASUREMENTS</b> - Measurement sketch needed. Height 1500 - 2100 mm. Shower tray installation measurement 750 - 1300 mm. One stabiliser included with custom widths 900 mm and wider. Price for combination of custom and standard measurement: (custom price + standard price) / 2. <b>Surcharge for triangular and rectangular cut-outs.</b>					



Art. no.	Frame colour	Glazing	Glass finishing (optional)
5			

Base price

Surcharge

WM	left	right	MH High-gloss metal	WS White/chrome	EK Glass clear RW Strip Satin SA Satin	C ARTCLEAR GLAZING
800I	5TR0 4H		1,898	2,126		
900II	5TR0 2H		1,933	2,165		
1000II	5TR0 6H		1,967	2,203		
900/800I	5TR1 AH	5TR2 AH	1,933	2,165		
1200/900II	5TR1 GH	5TR2 GH	1,985	2,223		
					EK 0 RW - SA -	417
800I	5TR0 47		1,843	2,064		
900II	5TR0 27		1,877	2,102		
1000II	5TR0 67		1,911	2,140		
900/800I	5TR1 A7	5TR2 A7	1,877	2,102		
1200/900II	5TR1 G7	5TR2 G7	1,928	2,159		
	5TR0 88		2,157	2,416		
			322	322		
800	5WE0 4H		1,672	1,873		
900	5WE0 5H		1,701	1,905		
900/750	5WE0 DH		▶ 1,679	1,880		
750/900	5WE0 CH		▶ 1,687	1,889		
900/800	5WE0 9H		▶ 1,687	1,889		
800/900	5WE0 7H		▶ 1,687	1,889		
					EK 0 RW 518 SA 692	417
800	5WE0 47		1,620	1,814		
900	5WE0 57		1,650	1,848		
900/750	5WE0 D7		▶ 1,627	1,822		
750/900	5WE0 C7		▶ 1,635	1,831		
900/800	5WE0 97		▶ 1,635	1,831		
800/900	5WE0 77		▶ 1,635	1,831		
	5WE0 88		2,041	2,286		
800	5TE0 4H		1,648	1,846		
900	5TE0 5H		1,681	1,883		
1000	5TE0 6H		1,718	1,924		
1200	5TE0 BH		1,789	2,004		
					EK 0 RW 518 SA 692	417
800	5TE0 47		1,597	1,789		
900	5TE0 57		1,632	1,828		
1000	5TE0 67		1,669	1,869		
1200	5TE0 B7		1,740	1,949		
	5TE0 88		2,020	2,262		
			322	322		

TWISTLINE

## IMPORTANT

- When ordering please indicate assembly on shower tray or flush with floor.

# TWISTLINE

Swinging door 6 mm ESG

ARTWEGER price list 03/2023. For specialised trade outlets only. Suggested retail prices in EUR not including VAT.  
DIMENSIONS IN MILLIMETRES.

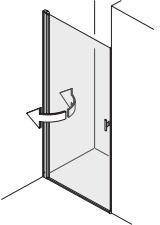
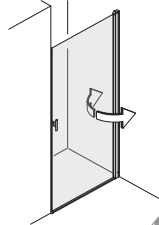
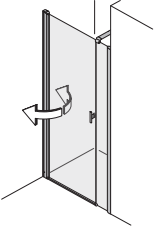
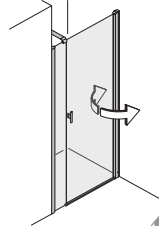
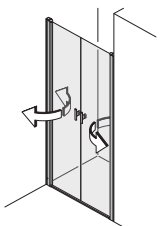
Hinge left	Hinge right	Height	Shower tray measurement (WM)	Shower tray installation measurement	Fixed part width Quantity stabilisers	Entrance width	
<b>Swinging door in alcove</b>		<b>2040</b>	800	782 - 800	-	700	
			900	882 - 900	-	800	
			1000	982 - 1000	-	900	
1 door part without fixed part			<b>1900</b>	800	782 - 800	-	700
				900	882 - 900	-	800
				1000	982 - 1000	-	900
<b>CUSTOM MEASUREMENTS</b> - Measurement sketch needed. Height 1500 - 2100 mm. Shower tray installation measurement 700 - 1000 mm. <b>Surcharge for triangular cut-outs.</b>							
<b>Swinging door next to fixed part in alcove</b>		<b>2040</b>	800	764 - 800	125 - 145	580	
			900	864 - 900	115 - 135	690	
			1000	964 - 1000	215 - 235	690	
1 door part and 1 fixed part			<b>1900</b>	1200	1164 - 1200	415 - 435	1 690
				1400	1364 - 1400	615 - 635	1 690
				1600	1564 - 1600	815 - 835	1 690
Stabiliser 1200 mm. Length must be adjusted on site.							
<b>CUSTOM MEASUREMENTS</b> - Measurement sketch needed. Height 1500 - 2100 mm. Shower tray installation measurement 750 - 1800 mm. door max. 1000 mm. One stabiliser included with widths 1200 mm and wider. <b>Surcharge for triangular and rectangular cut-outs.</b>							
<b>Double swinging door in alcove</b>		<b>2040</b>	800	764 - 800	-	650	
			900	864 - 900	-	750	
2 door parts			<b>1900</b>	1000	964 - 1000	-	850
				1200	1164 - 1200	-	1050
<b>CUSTOM MEASUREMENTS</b> - Measurement sketch needed. Height 1500 - 2100 mm. Shower tray installation measurement 750 - 1800 mm.							

**IMPORTANT**

Art. no.		Frame colour		Glazing		Glass finishing (optional)	
5							
Base price				Surcharge			
WM	left	right	MH High-gloss metal	WS White/chrome	EK Glass clear RW Strip Satin SA Satin	C ARTCLEAR GLAZING	
800	5W51 4H	5W52 4H	1,112	1,245	EK 0 RW 259 SA 351	211	
900	5W51 5H	5W52 5H	1,128	1,263			
1000	5W51 6H	5W52 6H	1,141	1,278			
800	5W51 47	5W52 47	1,078	1,207	EK 0 RW 259 SA 351	211	
900	5W51 57	5W52 57	1,092	1,223			
1000	5W51 67	5W52 67	1,111	1,244			
	5W51 88	5W52 88	1,351	1,513			
			322	322			
800	5W41 4H	5W42 4H	1,268	1,420	EK 0 RW 259 SA 351	211	
900	5W41 5H	5W42 5H	1,278	1,431			
1000	5W41 6H	5W42 6H	1,298	1,454			
1200	5W41 BH	5W42 BH	1,322	1,481	EK 0 RW 259 SA 351	211	
1400	5W41 EH	5W42 EH	1,349	1,511			
1600	5W41 KH	5W42 KH	1,378	1,543			
800	5W41 47	5W42 47	1,231	1,379	EK 0 RW 259 SA 351	211	
900	5W41 57	5W42 57	1,242	1,391			
1000	5W41 67	5W42 67	1,257	1,408			
1200	5W41 B7	5W42 B7	1,280	1,434	EK 0 RW 259 SA 351	211	
1400	5W41 E7	5W42 E7	1,309	1,466			
1600	5W41 K7	5W42 K7	1,334	1,494			
	5W41 88	5W42 88	1,536	1,720			
			322	322			
800	5WD0 4H		1,551	1,737	EK 0 RW 259 SA 351	211	
900	5WD0 5H		1,567	1,755			
1000	5WD0 6H		1,585	1,775			
1200	5WD0 BH		1,614	1,808	EK 0 RW 259 SA 351	211	
800	5WD0 47		1,506	1,687			
900	5WD0 57		1,522	1,705			
1000	5WD0 67		1,534	1,718	EK 0 RW 259 SA 351	211	
1200	5WD0 B7		1,566	1,754			
	5WD0 88		1,882	2,108			

TWISTLINE

### IMPORTANT

- When ordering please indicate assembly on shower tray or flush with floor.

# TWISTLINE

Swinging door 6 mm ESG

ARTWEGER price list 03/2023. For specialised trade outlets only. Suggested retail prices in EUR not including VAT.  
DIMENSIONS IN MILLIMETRES.

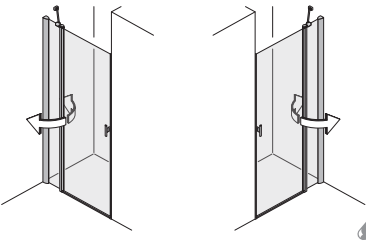
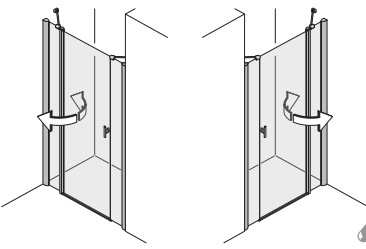
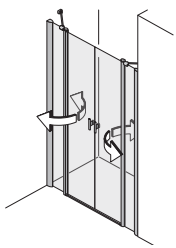
Hinge left	Hinge right	Height	Shower tray measurement (WM)	Shower tray installation measurement	Fixed part width Quantity stabilisers	Entrance width		
<p><b>Swinging door attached on fixed part in alcove</b></p>  <p>1 door part and 1 fixed part</p>		<b>2040</b>	800	782 - 800	230 - 250	-	530	
			900	882 - 900	280 - 300	1	580	
			1000	982 - 1000	280 - 300	1	680	
			1200	1182 - 1200	480 - 500	1	680	
		<b>1900</b>	800	782 - 800	230 - 250	-	530	
			900	882 - 900	280 - 300	1	580	
			1000	982 - 1000	280 - 300	1	680	
			1200	1182 - 1200	480 - 500	1	680	
		<p><b>CUSTOM MEASUREMENTS</b> - Measurement sketch needed. Height 1500 - 2100 mm. Shower tray installation measurement 750 - 1300 mm. One stabiliser included with custom widths 900 mm and wider. <b>Surcharge for triangular and rectangular cut-outs.</b></p>						
		<p><b>Swinging door attached on fixed part in alcove</b></p>  <p>1 door part and 2 fixed parts</p>		<b>2040</b>	900	864 - 900	180 - 200	-
1000	964 - 1000				205 - 225	-	580	
1200	1164 - 1200				255 - 275	-	680	
1400	1364 - 1400				355 - 375	2	680	
<b>1900</b>	900			864 - 900	180 - 200	-	530	
	1000			964 - 1000	205 - 225	-	580	
	1200			1164 - 1200	255 - 275	-	680	
	1400			1364 - 1400	355 - 375	2	680	
<p><b>CUSTOM MEASUREMENTS</b> - Measurement sketch needed. Height 1500 - 2100 mm. Shower tray installation measurement 900 - 1800 mm. One stabiliser included with widths 1210 mm and wider. <b>Surcharge for triangular and rectangular cut-outs.</b></p>								
<p><b>Double swinging door attached on fixed part in alcove</b></p>  <p>2 door parts and 2 fixed parts</p>				<b>2040</b>	1200	1164 - 1200	185 - 205	-
		1400	1364 - 1400		285 - 305	2	790	
		<b>1900</b>	1200	1164 - 1200	185 - 205	-	790	
			1400	1364 - 1400	285 - 305	2	790	
		<p><b>CUSTOM MEASUREMENTS</b> - Measurement sketch needed. Height 1500 - 2100 mm. Shower tray installation measurement 1100 - 2000 mm. Two stabilisers included with widths over 1350 mm and wider. <b>Surcharge for triangular and rectangular cut-outs.</b></p>						

**IMPORTANT**

Art. no.		Frame colour		Glazing		Glass finishing (optional)				
5										
Base price				Surcharge						
WM	left	right	MH High-gloss metal	WS White/chrome	EK Glass clear RW Strip Satin SA Satin	C ARTCLEAR GLAZING				
800	5T51 4H	5T52 4H	1,084	1,214	EK 0 RW 259 SA 351	211				
900	5T51 5H	5T52 5H	1,094	1,225						
1000	5T51 6H	5T52 6H	1,110	1,243						
1200	5T51 BH	5T52 BH	1,133	1,269						
800	5T51 47	5T52 47	1,049	1,175						
900	5T51 57	5T52 57	1,064	1,192						
1000	5T51 67	5T52 67	1,076	1,205						
1200	5T51 B7	5T52 B7	1,101	1,233						
	5T51 88	5T52 88	1,314	1,472						
			322	322						
900	5T41 5H	5T42 5H	1,315	1,473				EK 0 RW 259 SA 351	211	
1000	5T41 6H	5T42 6H	1,331	1,491						
1200	5T41 BH	5T42 BH	1,363	1,527						
1400	5T41 EH	5T42 EH	1,387	1,553						
900	5T41 57	5T42 57	1,275	1,428						
1000	5T41 67	5T42 67	1,292	1,447						
1200	5T41 B7	5T42 B7	1,320	1,478						
1400	5T41 E7	5T42 E7	1,350	1,512						
	5T41 88	5T42 88	1,598	1,790						
			322	322						
1200	5TD0 BH		1,595	1,786	EK 0 RW 461 SA 692	316				
1400	5TD0 EH		1,631	1,827						
1200	5TD0 B7		1,546	1,732						
1400	5TD0 E7		1,583	1,773						
	5TD0 88		1,914	2,144						
			322	322						

TWISTLINE

### IMPORTANT

- When ordering please indicate assembly on shower tray or flush with floor.

# TWISTLINE

Swinging door / Side screen 6 mm ESG

ARTWEGER price list 03/2023. For specialised trade outlets only. Suggested retail prices in EUR not including VAT.  
DIMENSIONS IN MILLIMETRES.

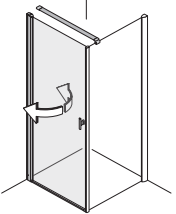
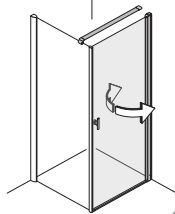
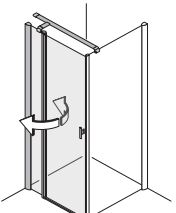
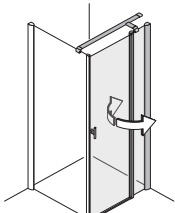
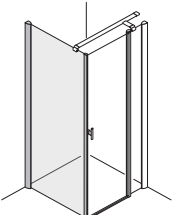
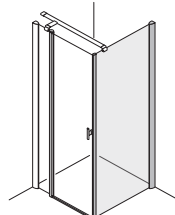
Hinge left	Hinge right	Height	Shower tray measurement (WM)	Shower tray installation measurement	Fixed part width Quantity stabilisers	Entrance width
<b>Swinging door next to side screen</b>		<b>2040</b>	800	782 - 800	- 1	680
			900	882 - 900	- 1	780
			1000	982 - 1000	- 1	880
<b>1 door part</b>		<b>1900</b>	800	782 - 800	- 1	680
			900	882 - 900	- 1	780
			1000	982 - 1000	- 1	880
Rotating tube always on the wall side. Stabiliser 1200 mm. Length must be adjusted on site.						
<b>CUSTOM MEASUREMENTS - Measurement sketch needed.</b>						
Height 1500 - 2100 mm. Shower tray installation measurement 700 - 1000 mm.						
<b>Surcharge for triangular cut-outs.</b>						
<b>Swinging door attached on fixed part next to side screen</b>		<b>2040</b>	800	782 - 800	210 - 230 1	530
			900	882 - 900	260 - 280 1	580
			1000	982 - 1000	260 - 280 1	680
<b>1 door part and 1 fixed part</b>			1200	1182 - 1200	460 - 480 1	680
		<b>1900</b>	800	782 - 800	210 - 230 1	530
900	882 - 900		260 - 280 1	580		
1000	982 - 1000		260 - 280 1	680		
1200	1182 - 1200		460 - 480 1	680		
Rotating tube always on the wall side. Stabiliser 1200 mm. Length must be adjusted on site.						
<b>CUSTOM MEASUREMENTS - Measurement sketch needed.</b>						
Height 1500 - 2100 mm. Shower tray installation measurement 750 - 1300 mm.						
<b>Surcharge for triangular and rectangular cut-outs.</b>						
<b>Side screen</b>		<b>2040</b>	800	782 - 800	- -	-
			900	882 - 900	- -	-
			1000	982 - 1000	- -	-
<b>1 door part and 1 fixed part</b>		<b>1900</b>	800	782 - 800	- -	-
			900	882 - 900	- -	-
			1000	982 - 1000	- -	-
<b>CUSTOM MEASUREMENTS - Measurement sketch needed.</b>						
Height 1500 - 2100 mm. Shower tray installation measurement 200 - 1200 mm.						
<b>Surcharge for triangular and rectangular cut-outs.</b>						

Art. no.		Frame colour		Glazing		Glass finishing (optional)	
5							
Base price				Surcharge			
WM	left	right	MH High-gloss metal	WS White/chrome	EK Glass clear RW Strip Satin SA Satin	C ARTCLEAR GLAZING	
800	5W21 4H	5W22 4H	1,112	1,245	EK 0 RW 259 SA 351	211	
900	5W21 5H	5W22 5H	1,128	1,263			
1000	5W21 6H	5W22 6H	1,141	1,278			
800	5W21 47	5W22 47	1,078	1,207	EK 0 RW 259 SA 351	211	
900	5W21 57	5W22 57	1,092	1,223			
1000	5W21 67	5W22 67	1,111	1,244			
	5W21 88	5W22 88	1,351	1,513			
			322	322			
800	5T21 4H	5T22 4H	1,112	1,245	EK 0 RW 259 SA 351	211	
900	5T21 5H	5T22 5H	1,128	1,263			
1000	5T21 6H	5T22 6H	1,141	1,278			
1200	5T21 BH	5T22 BH	1,174	1,315			
800	5T21 47	5T22 47	1,078	1,207	EK 0 RW 259 SA 351	211	
900	5T21 57	5T22 57	1,092	1,223			
1000	5T21 67	5T22 67	1,111	1,244			
1200	5T21 B7	5T22 B7	1,139	1,276			
	5T21 88	5T22 88	1,351	1,513			
			322	322			
800	5T10 4H		621	696	EK 0 RW 204 SA 351	211	
900	5T10 5H		638	715			
1000	5T10 6H		654	732			
800	5T10 47		600	672	EK 0 RW 204 SA 351	211	
900	5T10 57		622	697			
1000	5T10 67		638	715			
	5T10 88		767	859			
			322	322			

TWISTLINE

### IMPORTANT

- When ordering please indicate assembly on shower tray or flush with floor.

# TWISTLINE

Swinging door / Side screen 6 mm ESG

ARTWEGER price list 03/2023. For specialised trade outlets only. Suggested retail prices in EUR not including VAT.  
DIMENSIONS IN MILLIMETRES.

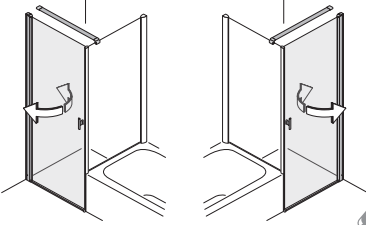
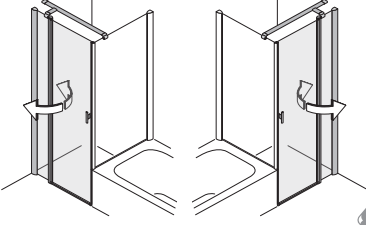
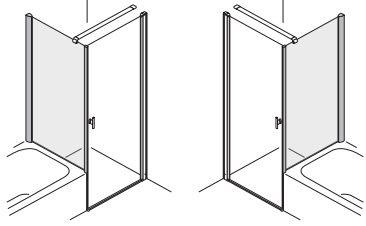
Hinge left	Hinge right	Height	Shower tray measurement (WM)	Shower tray installation measurement	Fixed part width Quantity stabilisers	Entrance width	
<b>Swinging door next to shortened side screen</b>  1 door part		<b>2040</b>	800	782 - 800	-	1	700
			900	882 - 900	-	1	800
			1000	982 - 1000	-	1	900
		<b>1900</b>	800	782 - 800	-	1	700
			900	882 - 900	-	1	800
			1000	982 - 1000	-	1	900
Rotating tube always on the wall side. Stabiliser 1200 mm. Length must be adjusted on site.							
<b>CUSTOM MEASUREMENTS - Measurement sketch needed.</b> Height 1500 - 2100 mm. Shower tray installation measurement 700 - 1000 mm. <b>Surcharge for triangular cut-outs.</b>							
<b>Swinging door attached on fixed part next to shortened side screen</b>  1 door part and 1 fixed part		<b>2040</b>	800	782 - 800	230 - 250	1	530
			900	882 - 900	280 - 300	1	580
			1000	982 - 1000	280 - 300	1	680
		<b>1900</b>	800	782 - 800	230 - 250	1	530
			900	882 - 900	280 - 300	1	580
			1000	982 - 1000	280 - 300	1	680
Rotating tube always on the wall side. Stabiliser 1200 mm. Length must be adjusted on site.							
<b>CUSTOM MEASUREMENTS - Measurement sketch needed.</b> Height 1500 - 2100 mm. Shower tray installation measurement 750 - 1300 mm. <b>Surcharge for triangular and rectangular cut-outs.</b>							
<b>Shortened side screen</b> 		<b>CUSTOM MEASUREMENTS - Measurement sketch needed.</b> Height 1000 - 2100 mm. Shower tray installation measurement 200 - 1000 mm.			-	-	-
		<b>Surcharge for triangular and rectangular cut-outs.</b>					

**IMPORTANT**



Art. no.		Frame colour		Glazing		Glass finishing (optional)	
5							
Base price				Surcharge			
WM	left	right	MH High-gloss metal	WS White/chrome	EK Glass clear RW Strip Satin SA Satin	C ARTCLEAR GLAZING	
800	5W31 4H	5W32 4H	1,112	1,245	EK 0 RW 259 SA 351	211	
900	5W31 5H	5W32 5H	1,128	1,263			
1000	5W31 6H	5W32 6H	1,141	1,278			
800	5W31 47	5W32 47	1,078	1,207	EK 0 RW 259 SA 351	211	
900	5W31 57	5W32 57	1,092	1,223			
1000	5W31 67	5W32 67	1,111	1,244			
	5W31 88	5W32 88	1,351	1,513			
			322	322			
800	5T31 4H	5T32 4H	1,112	1,245	EK 0 RW 259 SA 351	211	
900	5T31 5H	5T32 5H	1,128	1,263			
1000	5T31 6H	5T32 6H	1,141	1,278			
800	5T31 47	5T32 47	1,078	1,207	EK 0 RW 259 SA 351	211	
900	5T31 57	5T32 57	1,092	1,223			
1000	5T31 67	5T32 67	1,111	1,244			
	5T31 88	5T32 88	1,351	1,513			
			322	322			
	5T61 88	5T62 88	841	942	EK 0 RW 204 SA 351	211	
			322	322			

TWISTLINE

### IMPORTANT

- When ordering please indicate assembly on shower tray or flush with floor.

# TWISTLINE

Swinging door / Side screen 6 mm ESG

ARTWEGER price list 03/2023. For specialised trade outlets only. Suggested retail prices in EUR not including VAT.  
DIMENSIONS IN MILLIMETRES.

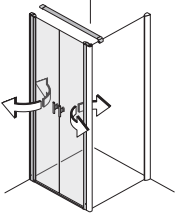
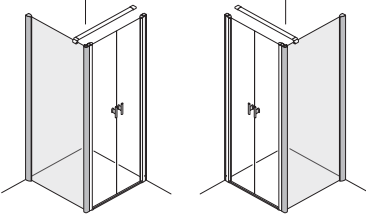
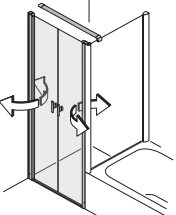
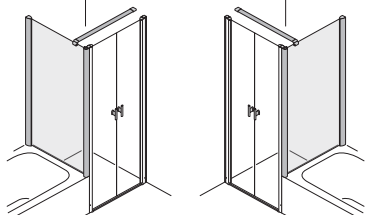
left	right	Height	Shower tray measurement (WM)	Shower tray installation measurement	Fixed part width Quantity stabilisers	Entrance width	
<b>Double swinging door next to side screen</b> 		<b>2040</b>	800	764 - 800	-	1	620
			900	864 - 900	-	1	720
			1000	964 - 1000	-	1	820
		<b>1900</b>	800	764 - 800	-	1	620
			900	864 - 900	-	1	720
			1000	964 - 1000	-	1	820
Rotating tube always on the wall side. Stabiliser 1200 mm. Length must be adjusted on site.							
<b>CUSTOM MEASUREMENTS</b> - Measurement sketch needed. Height 1500 - 2100 mm. Shower tray installation measurement 750 - 1200 mm.							
<b>Side screen fits double swinging door</b> 		<b>2040</b>	800	782 - 800	-	-	-
			900	882 - 900	-	-	-
			1000	982 - 1000	-	-	-
		<b>1900</b>	800	782 - 800	-	-	-
			900	882 - 900	-	-	-
			1000	982 - 1000	-	-	-
<b>CUSTOM MEASUREMENTS</b> - Measurement sketch needed. Height 1500 - 2100 mm. Shower tray installation measurement 200 - 1200 mm. <b>Surcharge for triangular and rectangular cut-outs.</b>							
<b>Double swinging door next to shortened side screen</b> 		<b>2040</b>	800	764 - 800	-	1	650
			900	864 - 900	-	1	750
			1000	964 - 1000	-	1	850
		<b>1900</b>	800	764 - 800	-	1	650
			900	864 - 900	-	1	750
			1000	964 - 1000	-	1	850
Rotating tube always on the wall side. Stabiliser 1200 mm. Length must be adjusted on site.							
<b>CUSTOM MEASUREMENTS</b> - Measurement sketch needed. Height 1500 - 2100 mm. Shower tray installation measurement 750 - 1200 mm.							
<b>Shortened side screen fits double swinging door</b> 		<b>CUSTOM MEASUREMENTS</b> - Measurement sketch needed. Height 1300 - 2100 mm. Shower tray installation measurement 200 - 1000 mm.				-	-
		<b>Surcharge for triangular and rectangular cut-outs.</b>					

**IMPORTANT**

Art. no.		Frame colour		Glazing		Glass finishing (optional)	
5							
Base price				Surcharge			
WM	left	right	MH High-gloss metal	WS White/chrome	EK Glass clear RW Strip Satin SA Satin	C ARTCLEAR GLAZING	
800	5WS04H		1,551	1,737	EK 0 RW 259 SA 351	211	
900	5WS05H		1,567	1,755			
1000	5WS06H		1,585	1,775			
800	5WS047		1,506	1,687	EK 0 RW 259 SA 351	211	
900	5WS057		1,522	1,705			
1000	5WS067		1,534	1,718			
	5WS088		1,882	2,108			
800	5W114H	5W124H	675	756	EK 0 RW 204 SA 351	211	
900	5W115H	5W125H	692	775			
1000	5W116H	5W126H	710	795			
800	5W1147	5W1247	657	736	EK 0 RW 204 SA 351	211	
900	5W1157	5W1257	676	757			
1000	5W1167	5W1267	692	775			
	5W1188	5W1288	820	918			
			322	322			
800	5WT04H		1,551	1,737	EK 0 RW 259 SA 351	211	
900	5WT05H		1,567	1,755			
1000	5WT06H		1,585	1,775			
800	5WT047		1,506	1,687	EK 0 RW 259 SA 351	211	
900	5WT057		1,522	1,705			
1000	5WT067		1,534	1,718			
	5WT088		1,882	2,108			
	5W6188	5W6288	841	942	EK 0 RW 204 SA 351	211	
			322	322			

TWISTLINE

### IMPORTANT

- When ordering please indicate assembly on shower tray or flush with floor.

# TWISTLINE

Swinging door 6 mm ESG

ARTWEGER price list 03/2023. For specialised trade outlets only. Suggested retail prices in EUR not including VAT.  
DIMENSIONS IN MILLIMETRES.

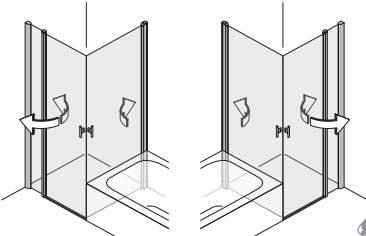
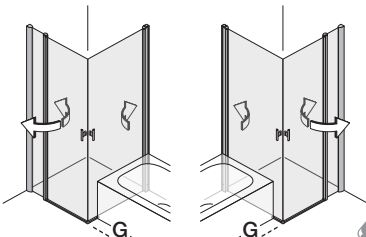
Hinge left	Hinge right	Height	Shower tray measurement (WM)	Shower tray installation measurement	Fixed part width	Entrance width
<b>Swinging door attached on fixed part with swinging side screen next to bathtub</b>  1 door part and 1 fixed part		<b>2040</b>	left 800 × 800	right 782 - 800	210 - 230	530
left 900 × 900	right 882 - 900		260 - 280	580		
left 1000 × 1000	right 982 - 1000		260 - 280	680		
left 900 × 750 Door at 900	right 882 - 900 × 732 - 750		260 - 280	580		
<b>Swinging door attached on fixed part with swinging side screen next to bathtub</b>  1 door part and 1 fixed part Shower tray and bathtub not flush.		<b>1900</b>	left 800 × 800	right 782 - 800	210 - 230	530
left 900 × 900	right 882 - 900		260 - 280	580		
left 1000 × 1000	right 982 - 1000		260 - 280	680		
left 900 × 750 Door at 900	right 882 - 900 × 732 - 750		260 - 280	580		
<b>CUSTOM MEASUREMENTS - Measurement sketch needed.</b> Height 1500 - 2100 mm. Shower tray installation measurement 750 - 1000 mm. Price for combination of custom and standard measurement: (custom price + standard price) / 2. <b>Surcharge for triangular and rectangular cut-outs.</b>						



Detail of the swinging side screen when adjoined to the bathtub.

**IMPORTANT**

Art. no.		Frame colour		Glazing		Glass finishing (optional)	
5							
Base price				Surcharge			
WM	left	right	MH High-gloss metal	WS White/chrome	EK Glass clear RW Strip Satin SA Satin	C ARTCLEAR GLAZING	
800	5TA1 4H	5TA2 4H	1,826	2,045	EK 0 RW 518 SA 692	417	
900	5TA1 5H	5TA2 5H	1,844	2,065			
1000	5TA1 6H	5TA2 6H	1,873	2,098			
900/750	5TA1 CH	5TA2 CH	1,893	2,120			
800	5TA1 47	5TA2 47	1,770	1,982	EK 0 RW 518 SA 692	417	
900	5TA1 57	5TA2 57	1,788	2,003			
1000	5TA1 67	5TA2 67	1,817	2,035			
900/750	5TA1 C7	5TA2 C7	1,834	2,054			
	5TA1 88	5TA2 88	2,212	2,477			
			322	322			
800	5TB1 4H	5TB2 4H	1,826	2,045	EK 0 RW 518 SA 692	417	
900	5TB1 5H	5TB2 5H	1,844	2,065			
1000	5TB1 6H	5TB2 6H	1,873	2,098			
900/750	5TB1 CH	5TB2 CH	1,893	2,120			
800	5TB1 47	5TB2 47	1,770	1,982	EK 0 RW 518 SA 692	417	
900	5TB1 57	5TB2 57	1,788	2,003			
1000	5TB1 67	5TB2 67	1,817	2,035			
900/750	5TB1 C7	5TB2 C7	1,834	2,054			
	5TB1 88	5TB2 88	2,212	2,477			
			322	322			

TWISTLINE

**Did you not find a suitable model?**  
**We have the right solution for your very special wishes for your own bathroom.**  
**Contact us!**  
**ARTWEGER – Your specialist for customized, individual solutions!**

**IMPORTANT**

- When ordering please indicate assembly on shower tray or flush with floor.

# TWISTLINE Folding doors

Let it twist!

- Folding doors without fixed part
- 180° rotating-cylinder wall connector, between the glass elements wing hinges 180° opening outwards
- Barrier-free
- Raise and lower mechanism
- Certified adhesion technique
- 6 mm single-pane safety glass
- Standard height 2040 mm
- Adjustment range 18 mm
- Custom sizes available



Especially EASY TO CLEAN.

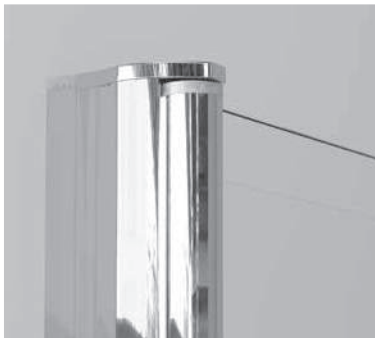

The RAISE-LOWER hinge provides simple opening and closing of the doors. When opening, the door is raised gently. When closed, the door is lowered again.



**Artweger**

artclear  
GLASS



100 % FLUSH-TO-FLOOR ACCESS



LOVELY COMBINATION:  
Elegant straight handle on the outside and a knob inside. Colour chrome.

**IMPORTANT**

# ACCESSORIES

ARTWEGER price list 03/2023. For specialised trade outlets only.  
Suggested retail prices in EUR not including VAT. DIMENSIONS IN MILLIMETRES.

Art. no.	Colour
5	
Base price	

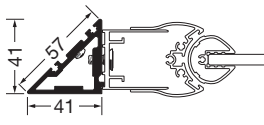
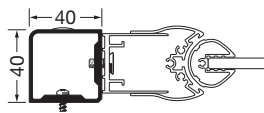
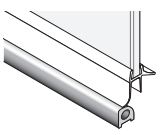
	Height	Art. no.	MH High-gloss metal	WS White
 <p><b>Mounting bracket, 45° for folding doors</b> For installation on tiled walls under 45°. Necessary additional information: article number of the respective shower enclosure.</p>	2040	<b>5T0P 9H</b>	259	290
	Custom size	<b>5T0P 98</b>	310	347
 <p><b>Mounting bracket for folding doors</b> For attaching to wall projections. Necessary additional information: article number of the respective shower enclosure.</p>	2040	<b>5T0P 2H</b>	259	290
	Custom size	<b>5T0P 28</b>	310	347
 <p><b>Overflow moulding</b> To enhance watertightness in the entrance area.</p>				
	Double folding door without fixed part	10	<b>5T00 22</b>	115
Corner entry with folding doors without fixed parts	10	<b>5T00 21</b>	169	189

## FOLDING DIRECTION OF TWISTLINE FOLDING DOORS.

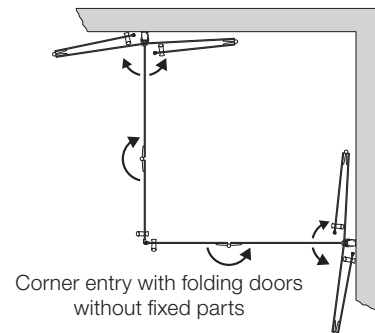
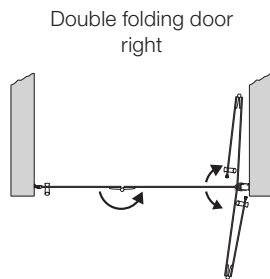
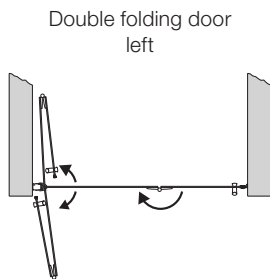

TWISTLINE

### IMPORTANT

- We will gladly send you the documents in hard copy on request.

# TWISTLINE

Folding door without fixed part / Side screen 6 mm ESG

ARTWEGER price list 03/2023. For specialised trade outlets only. Suggested retail prices in EUR not including VAT.  
DIMENSIONS IN MILLIMETRES.

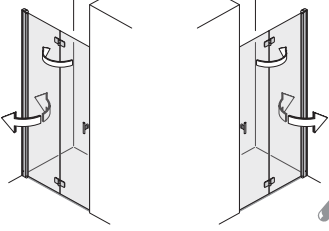
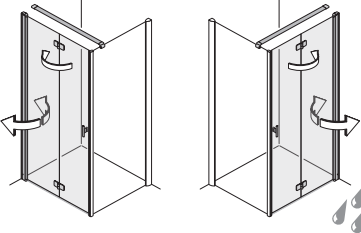
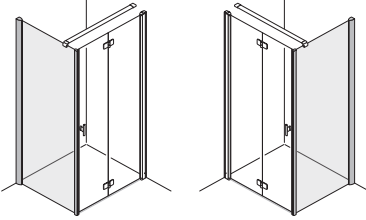
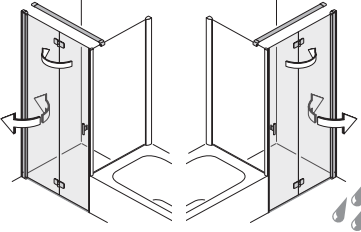
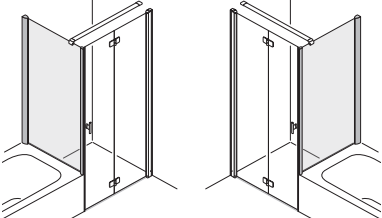
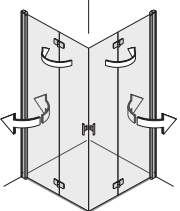
Hinge left	Hinge right	Height	Shower tray measurement (WM)	Shower tray installation measurement	Quantity stabilisers	Entrance width
<b>Double folding door in alcove</b>		<b>2040</b>	800	782 - 800	-	650
			900	882 - 900	-	750
			1000	982 - 1000	-	850
			1200	1182 - 1200	-	1050
<b>CUSTOM MEASUREMENTS</b> - Measurement sketch needed. Height 1400 - 2040 mm. Width up to 750 - 1200 mm.						
<b>Double folding door next to side screen</b>		<b>2040</b>	800	782 - 800	1	630
			900	882 - 900	1	730
			1000	982 - 1000	1	830
			1200	1182 - 1200	1	1030
Rotating tube always on the wall side. Stabiliser 1200 mm. Length must be adjusted on site.						
<b>CUSTOM MEASUREMENTS</b> - Measurement sketch needed. Height 1400 - 2040 mm. Width up to 750 - 1200 mm.						
<b>Side screen</b>		<b>2040</b>	800	782 - 800	-	-
			900	882 - 900	-	-
			1000	982 - 1000	-	-
<b>CUSTOM MEASUREMENTS</b> - Measurement sketch needed. Height 1400 - 2040 mm. Shower tray installation measurement 200 - 1200 mm.						
<b>Surcharge for triangular and rectangular cut-outs.</b>						
<b>Double folding door next to shortened side screen</b>		<b>2040</b>	800	782 - 800	1	650
			900	882 - 900	1	750
			1000	982 - 1000	1	850
			1200	1182 - 1200	1	1050
Rotating tube always on the wall side. Stabiliser 1200 mm. Length must be adjusted on site.						
<b>CUSTOM MEASUREMENTS</b> - Measurement sketch needed. Height 1400 - 2040 mm. Shower tray installation measurement 750 - 1200 mm.						
<b>Shortened side screen</b>		<b>CUSTOM MEASUREMENTS</b> - Measurement sketch needed. Height 700 - 2040 mm. Shower tray installation measurement 200 - 1200 mm.			-	-
		<b>Surcharge for triangular and rectangular cut-outs.</b>				
<b>Corner entry with folding doors</b>		<b>2040</b>	800 × 800	782 - 800 × 782 - 800	-	780
			900 × 900	882 - 900 × 882 - 900	-	920
			1000 × 1000	982 - 1000 × 982 - 1000	-	1060
			1200 × 1200	1182 - 1200 × 1182 - 1200	-	1320
<b>CUSTOM MEASUREMENTS</b> - Measurement sketch needed. Height 1500 - 2040 mm. Width up to 1200 mm.						

## IMPORTANT

- Required installation height is total height + 250 mm.
- Dimensions including dimension sketch required.



Art. no.	Frame colour	Glazing	Glass finishing (optional)
5			

Base price

Surcharge

WM	left	right	MH High-gloss metal	WS White/chrome	EK Glass clear RW Strip Satin	C ARTCLEAR GLAZING
800	5F51 4H	5F52 4H	1,559	1,746		
900	5F51 5H	5F52 5H	1,586	1,776	EK 0	211
1000	5F51 6H	5F52 6H	1,613	1,807	RW 259	
1200	5F51 BH	5F52 BH	1,670	1,870		
	5F51 88	5F52 88	1,844	2,065		
800	5F21 4H	5F22 4H	1,828	2,047		
900	5F21 5H	5F22 5H	1,854	2,076	EK 0	211
1000	5F21 6H	5F22 6H	1,882	2,108	RW 259	
1200	5F21 BH	5F22 BH	1,937	2,169		
	5F21 88	5F22 88	2,135	2,391		
800	5T10 4H		621	696		
900	5T10 5H		638	715	EK 0	211
1000	5T10 6H		654	732	RW 204	
	5T10 88		767	859		
			322	322		
800	5F31 4H	5F32 4H	1,828	2,047		
900	5F31 5H	5F32 5H	1,854	2,076	EK 0	211
1000	5F31 6H	5F32 6H	1,882	2,108	RW 259	
1200	5F31 BH	5F32 BH	1,937	2,169		
	5F31 88	5F32 88	2,135	2,391		
	5T61 88	5T62 88	841	942	EK 0	211
			322	322	RW 204	
800	5FE0 4H					
900	5FE0 5H		2,521	2,824	EK 0	417
1000	5FE0 6H				RW 518	
1200	5FE0 BH		2,634	2,950		
	5FE0 88		2,904	3,252		

TWISTLINE

**IMPORTANT**

- Execution without overflow moulding. Where the downward incline is insufficient or when mounting on a shower tray, a splash water bar is required for adequate protection. See page 121.

# Artweger DYNAMIC

Simply stylish.

- Swinging doors with fixed parts and Walk In
- Swinging doors with an opening angle of approx. 90 ° outwards and inwards
- Barrier-free with Vario sealing system
- Raise and lower mechanism
- Wall profile with 3D adjustment and concealed silicone joints for swinging doors
- Certified adhesion technique
- 6 mm single-pane safety glass
- Artweger DYNAMIC Walk In 6 mm and 8 mm standard height 2000 mm
- Adjustment range 20 mm, Artweger DYNAMIC Walk In 15 mm
- Custom widths available



The hinge combines rounded and angular elements to give a universal, versatile, complete design.



Certified adhesive technology for easy glass cleaning.



Continuous seals ensure water-tightness even around the hinges.



Unmistakeable and stylish flamboyant handles.



Artweger®

artclear  
GLASS

CE

according to EN 14428

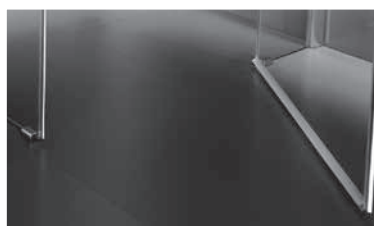

VARIO sealing system:  
You decide either for 100 %  
FLUSH-TO-FLOOR ACCESS or ...

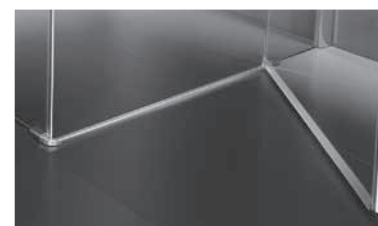

... for an optional surge bar which  
is only 12 mm high and provides  
IMPROVED SEALING of the door.

# ACCESSORIES

ARTWEGER price list 03/2023. For specialised trade outlets only.  
Suggested retail prices in EUR not including VAT. DIMENSIONS IN MILLIMETRES.

Art. no.				Colour	
6	0				
Base price					

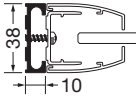
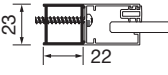
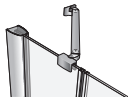
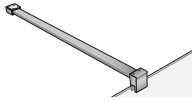
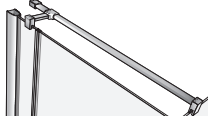
	Height / length	Art. no.	MH High-gloss metal
 <p><b>Compound bracket 10 mm</b> Extends adjustment range by 10 mm. Necessary additional information: article number of the respective shower enclosure. (Not suitable for Artweger DYNAMIC Walk In.)</p>	2000	<b>60P 39</b>	162
 <p><b>Compound bracket 22 mm DYNAMIC Walk In</b> Extends adjustment range of the DYNAMIC Walk In by 22 mm. Necessary additional information: article number of the respective shower enclosure.</p>	2000	<b>60P 49</b>	83
 <p><b>Stabiliser</b> Fits quarter-round shower, doors and corner entry.</p>	ca. 300	<b>600 01</b>	142
 <p><b>Side-screen stabiliser</b> Length has to be adjusted on site.</p>	ca. 1200	<b>600 02</b>	162
 <p><b>T-Stabilizer</b> Length has to be adjusted on site.</p>	ca. 1200	<b>600 03</b>	228

## IMPORTANT

- We will gladly send you the documents in hard copy on request.

# Artweger DYNAMIC PROMPT DELIVERY

ARTWEGER price list 03/2023. For specialised trade outlets only. Suggested retail prices in EUR not including VAT.  
DIMENSIONS IN MILLIMETRES.

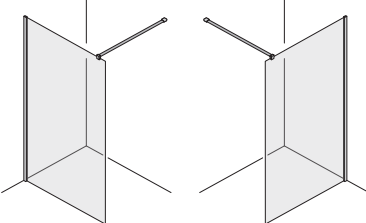
Artweger DYNAMIC - height 2000 mm	Shower tray measurement (WM)	Art. no.	Price in EUR
 <p><b>DYNAMIC Walk In</b></p> <p>High-gloss metal, glass clear 8 mm with ARTCLEAR</p>	785 - 800	<b>6WA 49 MH EK C</b>	1,083
	885 - 900	<b>6WA 59 MH EK C</b>	1,099
	985 - 1000	<b>6WA 69 MH EK C</b>	1,116
	1085 - 1100	<b>6WA 09 MH EK C</b>	1,134
	1185 - 1200	<b>6WA B9 MH EK C</b>	1,152
	1285 - 1300	<b>6WA D9 MH EK C</b>	1,178
	1385 - 1400	<b>6WA E9 MH EK C</b>	1,206

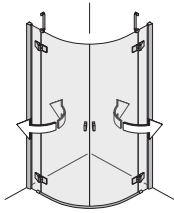

## DYNAMIC 1/4-round shower

High-gloss metal,  
glass clear 6 mm with ARTCLEAR  
2 swinging doors and 2 fixed parts

900 × 900 I R=500	<b>6R0 19 MH EK C</b>	2,157
900 × 900 II R=550	<b>6R0 29 MH EK C</b>	2,157
1000 × 1000 II R=550	<b>6R0 69 MH EK C</b>	2,187

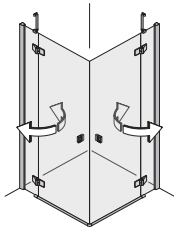

## DYNAMIC Corner entry

High-gloss metal,  
glass clear 6 mm with ARTCLEAR  
2 swinging doors and 2 fixed parts

800 × 800	<b>6E0 49 MH EK C</b>	1,899
900 × 900	<b>6E0 59 MH EK C</b>	1,929
1000 × 1000	<b>6E0 69 MH EK C</b>	1,964

# Artweger DYNAMIC PROMPT DELIVERY

ARTWEGER price list 03/2023. For specialised trade outlets only. Suggested retail prices in EUR not including VAT.  
DIMENSIONS IN MILLIMETRES.

Artweger DYNAMIC - height 2000mm

Shower tray measurement  
(WM)

Art. no.

Price in EUR

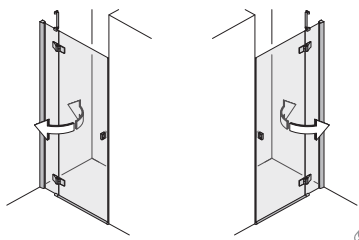

## DYNAMIC Swinging door attached on fixed part in alcove

**High-gloss metal,  
glass clear 6 mm with ARTCLEAR**  
1 door part and 1 fixed part

900	left	<b>651 59 MH EK C</b>	1,141
1000	left	<b>651 69 MH EK C</b>	1,154
900	right	<b>652 59 MH EK C</b>	1,141
1000	right	<b>652 69 MH EK C</b>	1,154

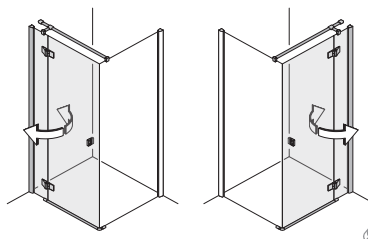

## DYNAMIC Swinging door attached on fixed part next to side screen

**High-gloss metal,  
glass clear 6 mm with ARTCLEAR**  
1 door part and 1 fixed part

800	left	<b>621 49 MH EK C</b>	1,202
900	left	<b>621 59 MH EK C</b>	1,202
1000	left	<b>621 69 MH EK C</b>	1,214
800	right	<b>622 49 MH EK C</b>	1,202
900	right	<b>622 59 MH EK C</b>	1,202
1000	right	<b>622 69 MH EK C</b>	1,214

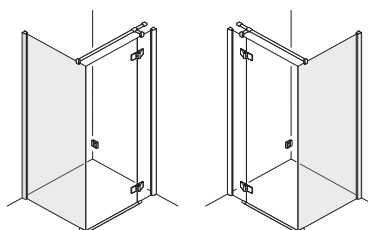

## DYNAMIC Side screen

**High-gloss metal,  
glass clear 6 mm with ARTCLEAR**

800	left	<b>611 49 MH EK C</b>	752
900	left	<b>611 59 MH EK C</b>	752
1000	left	<b>611 69 MH EK C</b>	767
800	right	<b>612 49 MH EK C</b>	752
900	right	<b>612 59 MH EK C</b>	752
1000	right	<b>612 69 MH EK C</b>	767

# Artweger DYNAMIC

Swinging door / Walk In 6 mm or 8 mm ESG

ARTWEGER price list 03/2023. For specialised trade outlets only. Suggested retail prices in EUR not including VAT.  
DIMENSIONS IN MILLIMETRES.

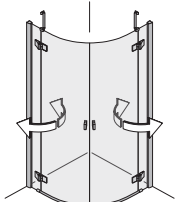
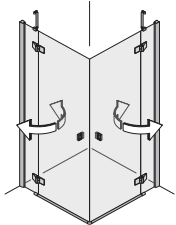
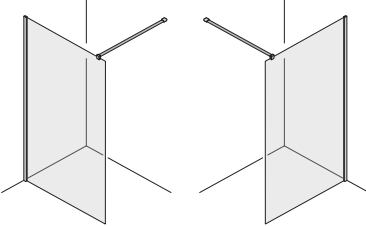
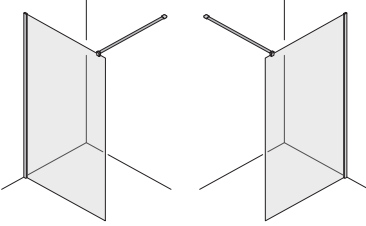
	Height	Shower tray measurement (WM) length a x width b	Shower tray installation measurement	Fixed part width Quantity stabilisers	Entrance width
<b>1/4-round shower</b> 	2000	800 × 800 I R=500	780 - 800	160 - 180 -	810
		900 × 900 I R=500	880 - 900	260 - 280 2	810
		900 × 900 II R=550	880 - 900	160 - 180 -	950
		1000 × 1000 II R=550	980 - 1000	260 - 280 2	950
		<b>CUSTOM WIDTH</b> - Measurement sketch needed. fixed-part custom width (narrower or wider). Width max. 1200 × 1200 mm. Custom heights, triangular and rectangular cut-outs not available.			
2 swinging doors and 2 fixed parts					
<b>Corner entry</b> 	2000	800 × 800	780 - 800	260 - 280 2	670
		900 × 900	880 - 900	260 - 280 2	810
		900 × 750	880 - 900 × 730 - 750	260 - 280 × 210 - 230 1	740
		750 × 900 left right	730 - 750 × 880 - 900	210 - 230 × 260 - 280 1	740
		900 × 800	880 - 900 × 780 - 800	260 - 280 × 260 - 280 2	740
		800 × 900	780 - 800 × 880 - 900	260 - 280 × 260 - 280 2	740
		1000 × 1000	980 - 1000	360 - 380 2	810
		<b>CUSTOM WIDTH</b> - Measurement sketch needed. Shower tray installation measurement 688 - 1200 mm. Custom heights, triangular and rectangular cut-outs not available. Price for combination of custom and standard measurement: (custom price + standard price) / 2.			
2 swinging doors and 2 fixed parts					
<b>Artweger DYNAMIC Walk In 6 mm ESG</b> 	2000	800	785 - 800	765 - 780 1	-
		900	885 - 900	865 - 880 1	-
		1000	985 - 1000	965 - 980 1	-
		1100	1085 - 1100	1065 - 1080 1	-
		1200	1185 - 1200	1165 - 1180 1	-
		1300	1285 - 1300	1265 - 1280 1	-
		1400	1385 - 1400	1365 - 1380 1	-
		Including stabiliser, length 1200 mm. Length has to be adjusted on site.			
<b>CUSTOM WIDTH</b> - Measurement sketch needed. Shower tray installation measurement 500 - 1400 mm. Custom heights, triangular and rectangular cut-outs not available.					
<b>Artweger DYNAMIC Walk In 8 mm ESG</b> 	2000	800	785 - 800	765 - 780 1	-
		900	885 - 900	865 - 880 1	-
		1000	985 - 1000	965 - 980 1	-
		1100	1085 - 1100	1065 - 1080 1	-
		1200	1185 - 1200	1165 - 1180 1	-
		1300	1285 - 1300	1265 - 1280 1	-
		1400	1385 - 1400	1365 - 1380 1	-
		Including stabiliser, length 1200 mm. Length has to be adjusted on site.			
<b>CUSTOM WIDTH</b> - Measurement sketch needed. Shower tray installation measurement 500 - 1400 mm. Custom heights, triangular and rectangular cut-outs not available.					

## IMPORTANT

- Required installation height is total height + 100 mm.
- When ordering please indicate assembly on shower tray or flush with floor.

Art. no.		Frame colour	Glazing	Glass finishing (optional)
6				
		Base price	Surcharge	
WM	Art. no.	MH High-gloss metal	EK Glass clear	C ARTCLEAR GLAZING
800I	6R0 49	1,709		
900I	6R0 19	1,740	0	417
900II	6R0 29			
1000II	6R0 69	1,770		
	6R0 89	1,956		
800	6E0 49	1,482		
900	6E0 59	1,512	0	417
900/750	6E0 D9			
750/900	6E0 C9			
900/800	6E0 99			
800/900	6E0 79			
1000	6E0 69	1,547		
	6E0 89	1,816		
800	6W0 49	645		
900	6W0 59	663		
1000	6W0 69	680		
1100	6W0 09	698	0	256
1200	6W0 B9	717		
1300	6W0 D9	735		
1400	6W0 E9	754		
	6W0 89	850		
800	6WA 49	827		
900	6WA 59	843		
1000	6WA 69	860		
1100	6WA 09	878	0	256
1200	6WA B9	896		
1300	6WA D9	922		
1400	6WA E9	950		
	6WA 89	1,073		

## IMPORTANT

- CUSTOM WIDTH: The combination of optimised door and fixed width elements for the best functionality, stability and access. See page 132.

# Artweger DYNAMIC

Swinging door / Side screen 6 mm ESG

ARTWEGER price list 03/2023. For specialised trade outlets only. Suggested retail prices in EUR not including VAT.  
DIMENSIONS IN MILLIMETRES.

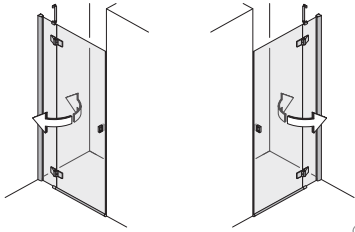
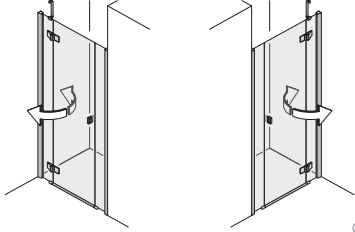
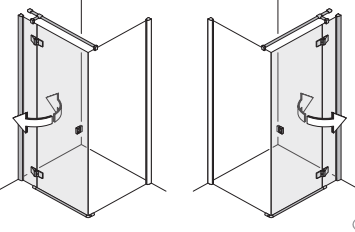
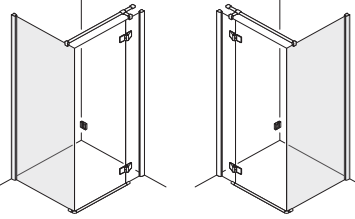
Hinge left	Hinge right	Height	Shower tray measurement (WM)	Shower tray installation measurement	Fixed part width Quantity stabilisers	Entrance width	
<b>Swinging door attached on fixed part in alcove</b> 		<b>2000</b>	800	780 - 800	170 - 190	-	570
			900	880 - 900	170 - 190	-	670
			1000	980 - 1000	270 - 290	1	670
			1200	1180 - 1200	470 - 490	1	670
<b>Swinging door attached on fixed part in alcove</b> 		<b>2000</b>	900	860 - 900	150 - 170	-	520
			1000	960 - 1000	175 - 195	-	570
			1200	1160 - 1200	225 - 245	1	670
<b>Swinging door attached on fixed part next to side screen</b> 		<b>2000</b>	800	780 - 800	200 - 220	1	520
			900	880 - 900	200 - 220	1	620
			1000	980 - 1000	250 - 270	1	670
			1200	1180 - 1200	450 - 470	1	670
		Hinge always on the wall side. Incl. stabiliser, length 1200 mm for side screen. Length has to be adjusted on site.					
<b>Side screen</b> 		<b>2000</b>	800	780 - 800	760 - 780	-	-
			900	880 - 900	860 - 880	-	-
			1000	980 - 1000	960 - 980	-	-
		<b>CUSTOM WIDTH - Measurement sketch needed.</b> Shower tray installation measurement 200 - 1200 mm. Custom heights, triangular and rectangular cut-outs not available.					

- Required installation height is total height + 100 mm.
- When ordering please indicate assembly on shower tray or flush with floor.



Art. no.		Frame colour	Glazing	Glass finishing (optional)	
6					
Base price			Surcharge		
WM	left	right	MH High-gloss metal	EK Glass clear	C ARTCLEAR GLAZING
800	651 49	652 49	930	0	211
900	651 59	652 59			
1000	651 69	652 69			
1200	651 B9	652 B9			
	651 89	652 89	1,139		
900	641 59	642 59	1,183	0	211
1000	641 69	642 69	1,198		
1200	641 B9	642 B9	1,227		
	641 89	642 89	1,444		
800	621 49	622 49	991	0	211
900	621 59	622 59			
1000	621 69	622 69			
1200	621 B9	622 B9			
	621 89	622 89	1,213		
800	611 49	612 49	541	0	211
900	611 59	612 59			
1000	611 69	612 69			
	611 89	612 89	670		

### IMPORTANT

- CUSTOM WIDTH: The combination of optimised door and fixed width elements for the best functionality, stability and access. See page 132.

# DYNAMIC - Determining the fixed part width for special dimensions

ARTWEGER price list 03/2023. For specialised trade outlets only. DIMENSIONS IN MILLIMETRES.

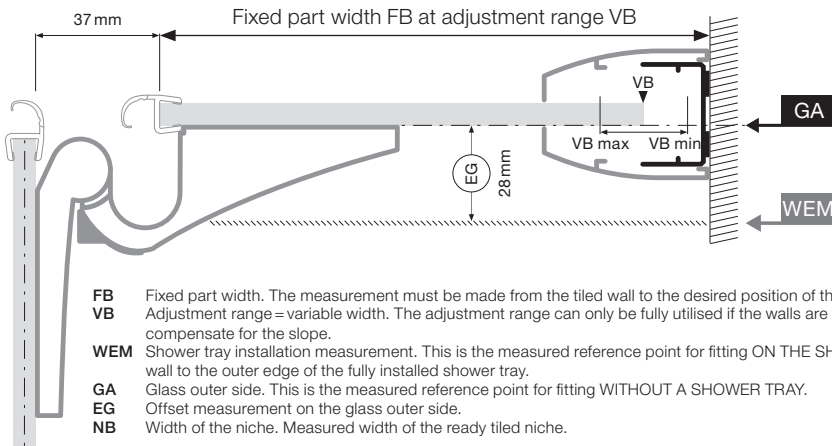

Deduction size allocation

Product	Shower tray installation measurement WEM from - up to in mm	Width of the niche NB from - up to in mm	Deduction dimension
1/4-round shower R=500	790 - 1200	-	650
1/4-round shower R=550	890 - 1200	-	750
Corner entry	688 - 810	-	548
	811 - 1010	-	648
Swinging door in alcove 1 fixed part	1011 - 1200	-	748
	-	776 - 889	636
Swinging door in alcove 2 fixed parts	-	890 - 1200	736
	-	852 - 901	610
	-	902 - 1001	660
Swinging door next to side screen	-	1002 - 1600	760
	748 - 847	-	608
	848 - 900	-	708
	901 - 1200	-	758

Calculation examples

ON shower tray	1/4-round shower R=550		Corner entry		Swinging door next to side screen
	left side	right side	left side	right side	
Measured width of the built-in shower tray WEM	1030	950	1100	830	860
minus deduction dimension	- 750	- 750	- 748	- 648	- 708
<b>gives fixed part width FB</b>	<b>= 280</b>	<b>= 200</b>	<b>= 352</b>	<b>= 182</b>	<b>= 152</b>

WITHOUT shower tray	1/4-round shower R=550		Corner entry		Swinging door next to side screen
	left side	right side	left side	right side	
Measured width to the desired position of the outer side of the glass GA	1030	950	1100	830	860
plus EG	+ 28	+ 28	+ 28	+ 28	+ 28
gives WEM	= 1058	= 978	= 1128	= 858	= 888
minus deduction dimension	- 750	- 750	- 748	- 648	- 708
<b>gives fixed part width FB</b>	<b>= 308</b>	<b>= 228</b>	<b>= 380</b>	<b>= 210</b>	<b>= 180</b>

IN ALCOVE	Swinging door 2 fixed parts	Swinging door 1 fixed part
Measured width of the niche NB = WEM	1300	860
minus deduction dimension	- 760	- 636
<b>gives fixed part width FB</b>	<b>= 540</b>	<b>= 224</b>
divided by quantity fixed parts	÷ 2	
<b>gives fixed part width FB</b>	<b>= 270</b>	



# Artweger MOVE

Brings your bathroom to life.

- Barrier free entry
- Overhead guided sliding doors
- Framed and frameless models
- Framed models including a 20 mm adjustment range
- Frameless models made to measure according to requirements
- 6 mm single-pane safety glass
- Standard height 2000 mm
- Custom sizes available



With SOFT OPEN / SOFT CLOSE (optional) the most up to date technology is hidden behind the elegant inside panel. The door is gently slowed down just before the end and then glides smoothly into the stop position.



The patent pending magnetic closure enables the door to swing open by lightly pressing it. This makes cleaning much easier.



The linear, simply designed handle is comfortable to hold and is easy to clean.

Artweger®

artclear  
GLASS

CE

according to EN 14428



VARIO sealing system:  
You decide either for 100 %  
FLUSH-TO-FLOOR ACCESS or ...



... for an optional surge bar which  
is only 12 mm high and provides  
IMPROVED SEALING of the door.

# ACCESSORIES

ARTWEGER price list 03/2023. For specialised trade outlets only.  
Suggested retail prices in EUR not including VAT. DIMENSIONS IN MILLIMETRES.

Art. no.

M 0

Base price

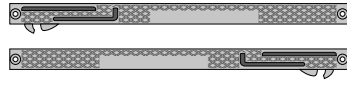

## Comfort system SOFT OPEN/SOFT CLOSE

Upgrade for existing Artweger MOVE sliding doors.  
(Two sets are required for quadruple sliding door and corner entry.)

Art. no.

M0001

141

## IMPORTANT

- We will gladly send you the documents in hard copy on request.

# Artweger MOVE PROMPT DELIVERY

ARTWEGER price list 03/2023. For specialised trade outlets only. Suggested retail prices in EUR not including VAT.  
DIMENSIONS IN MILLIMETRES.

Artweger MOVE - height 2000 mm

Shower tray measurement  
(WM)

Art. no.

Price in EUR

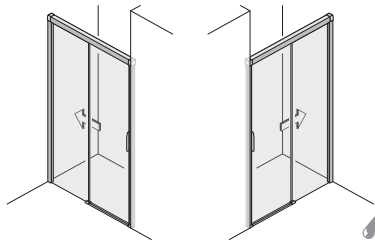

## MOVE Double sliding door in alcove

High-gloss metal,  
glass clear 6 mm with ARTCLEAR,  
SOFT OPEN / SOFT CLOSE  
1 door part and 1 fixed part

1200	left	<b>MG51 B9 MHEKCS</b>	1,733
1400	left	<b>MG51 E9 MHEKCS</b>	1,794
1200	right	<b>MG52 B9 MHEKCS</b>	1,733
1400	right	<b>MG52 E9 MHEKCS</b>	1,794

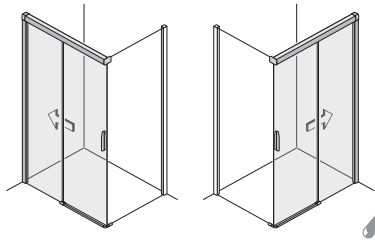

## MOVE Double sliding door next to side screen

High-gloss metal,  
glass clear 6 mm with ARTCLEAR,  
SOFT OPEN / SOFT CLOSE  
1 door part and 1 fixed part

1000	left	<b>MG21 69 MHEKCS</b>	1,658
1200	left	<b>MG21 B9 MHEKCS</b>	1,716
1000	right	<b>MG22 69 MHEKCS</b>	1,658
1200	right	<b>MG22 B9 MHEKCS</b>	1,716

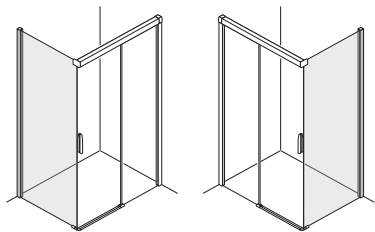

## MOVE Side screen

High-gloss metal,  
glass clear 6 mm with ARTCLEAR

900	left	<b>MG11 59 MHEKC</b>	948
1000	left	<b>MG11 69 MHEKC</b>	977
900	right	<b>MG12 59 MHEKC</b>	948
1000	right	<b>MG12 69 MHEKC</b>	977

# Artweger MOVE PROMPT DELIVERY

ARTWEGER price list 03/2023. For specialised trade outlets only. Suggested retail prices in EUR not including VAT.  
DIMENSIONS IN MILLIMETRES.

## Artweger MOVE - height 2000 mm

Shower tray measurement  
(WM)

Art. no.

Price in EUR

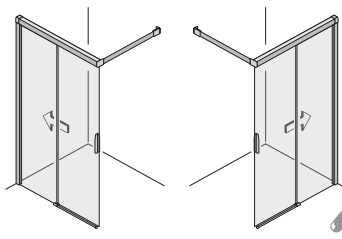

### MOVE Walk In

High-gloss metal,  
glass clear 6 mm with ARTCLEAR,  
SOFT OPEN / SOFT CLOSE  
1 door part and 1 fixed part

1200	left	<b>MGF1 B9 MHEKCS</b>	1,819
1400	left	<b>MGF1 E9 MHEKCS</b>	1,877
1200	right	<b>MGF2 B9 MHEKCS</b>	1,819
1400	right	<b>MGF2 E9 MHEKCS</b>	1,877

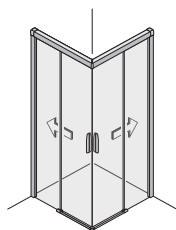

### MOVE Corner entry

High-gloss metal,  
glass clear 6 mm with ARTCLEAR,  
SOFT OPEN / SOFT CLOSE  
2 Sliding doors and 2 fixed parts

900 x 900	<b>MGE0 59 MHEKCS</b>	2,515
1000 x 1000	<b>MGE0 69 MHEKCS</b>	2,545

## Artweger MOVE - height 1500 mm

Nominal width

Art. no.

Price in EUR

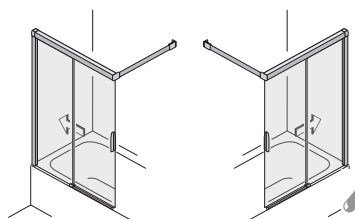

### MOVE Double sliding door free-standing on bathtub



High-gloss metal,  
glass clear 6 mm with ARTCLEAR,  
SOFT OPEN / SOFT CLOSE  
1 door part and 1 fixed part

1200	left	<b>MGK1 B2 MHEKCS</b>	1,683
1400	left	<b>MGK1 E2 MHEKCS</b>	1,729
1200	right	<b>MGK2 B2 MHEKCS</b>	1,683
1400	right	<b>MGK2 E2 MHEKCS</b>	1,729

# Artweger MOVE sliding door with frame

6 mm ESG

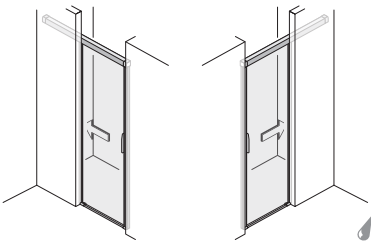
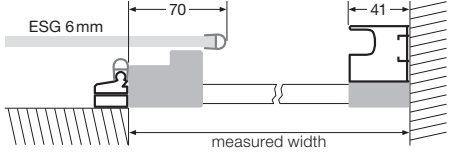
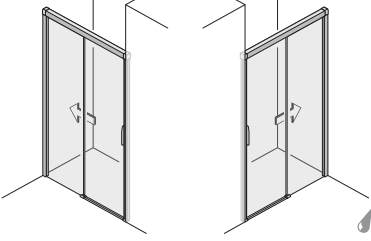
ARTWEGER price list 03/2023. For specialised trade outlets only. Suggested retail prices in EUR not including VAT.  
DIMENSIONS IN MILLIMETRES.

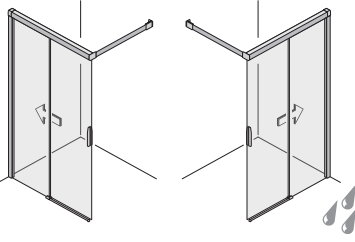
Fixed part left	Fixed part right	Height	Shower tray measurement (WM)	Shower tray installation measurement	Fixed part width	Entrance width
<b>Sliding door for partially bricked niche</b> 		<b>2000</b> 1000 - 1200 1201 - 1400 1401 - 1600	 <p>According to dimension sketch.</p>			
1 door part inside the shower area			<b>CUSTOM MEASUREMENTS</b> - Measurement sketch needed. Height 1800 - 2200 mm. Shower tray installation measurement 1000 - 1800 mm.			
<b>Double sliding door in alcove</b> 		<b>2000</b> 1000 1200 1400 1600	980 - 1000	457 - 477	390 - 410	
1 door part and 1 fixed part			1180 - 1200	557 - 577	490 - 510	
			1380 - 1400	657 - 677	590 - 610	
			1580 - 1600	757 - 777	690 - 710	
			<b>CUSTOM MEASUREMENTS</b> - Measurement sketch needed. Height 1800 - 2200 mm. Shower tray installation measurement 1000 - 1800 mm.			
<b>Quadruple sliding door in alcove</b> 		<b>2000</b> 1400 1600 1800 2000	1360 - 1400	318 - 338	535 - 575	
2 door parts and 2 fixed parts			1560 - 1600	368 - 388	635 - 675	
			1760 - 1800	418 - 438	735 - 775	
			1960 - 2000	468 - 488	835 - 875	
			<b>CUSTOM MEASUREMENTS</b> - Measurement sketch needed. Height 1800 - 2200 mm. Shower tray installation measurement 1400 - 2000 mm.			
<b>Double sliding door Walk In</b> 		<b>2000</b> 1000 1100 1200 1400 1600	Width			
1 door part and 1 fixed part			970 - 990	457 - 477	-	
			1070 - 1090	512 - 532	-	
			1170 - 1190	557 - 577	-	
			1370 - 1390	657 - 677	-	
			1570 - 1590	757 - 777	-	
Incl. stabiliser, length 1250 mm. Length has to be adjusted on site.						
<b>CUSTOM MEASUREMENTS</b> - Measurement sketch needed. Height 1800 - 2200 mm. Shower tray installation measurement 1000 - 1600 mm.						

## IMPORTANT

- Required installation height is total height + 100 mm.



Art. no.		Frame colour			Glazing		Glass finishing (optional)	Comfort system
MG								
Base price					Surcharge			
left	right	MH High-gloss metal	WS White SM Matt black LB Silver	WM Matt white GF Graphite metallic CN Champagne MK Mokka BZ Bronze . . . Additional colours	EK Glass clear RW Strip Satin SA Satin	C ARTCLEAR GLAZING	S SOFT OPEN SOFT CLOSE	
MGV1 B9	MGV2 B9	1,286	1,511	1,746	EK 0			
MGV1 E9	MGV2 E9	1,346	1,571	1,806	RW 204	211	116	
MGV1 K9	MGV2 K9	1,426	1,651	1,886	SA 351			
MGV1 88	MGV2 88	1,654	1,879	2,114				
MG51 69	MG52 69	1,347	1,572	1,807	EK 0			
MG51 B9	MG52 B9	1,406	1,631	1,866	RW 259	211	116	
MG51 E9	MG52 E9	1,467	1,692	1,927	SA 388			
MG51 K9	MG52 K9	1,547	1,772	2,007				
MG51 88	MG52 88	1,794	2,019	2,254				
MGD0 E9		2,031	2,256	2,491	EK 0			
MGD0 K9		2,094	2,319	2,554	RW 461	417	232	
MGD0 P9		2,155	2,380	2,615	SA 692			
MGD0 U9		2,355	2,580	2,815				
MGD0 88		2,591	2,816	3,051				
MGF1 69	MGF2 69	1,386	1,611	1,846	EK 0			
MGF1 09	MGF2 09	1,416	1,641	1,876	RW 259	256	116	
MGF1 B9	MGF2 B9	1,447	1,672	1,907	SA 388			
MGF1 E9	MGF2 E9	1,505	1,730	1,965				
MGF1 K9	MGF2 K9	1,568	1,793	2,028				
MGF1 88	MGF2 88	1,611	1,836	2,071				

Artweger  
MOVE

## IMPORTANT

- When ordering please indicate assembly on shower tray or flush with floor.

# Artweger MOVE sliding door with frame

6 mm ESG

ARTWEGER price list 03/2023. For specialised trade outlets only. Suggested retail prices in EUR not including VAT.  
DIMENSIONS IN MILLIMETRES.

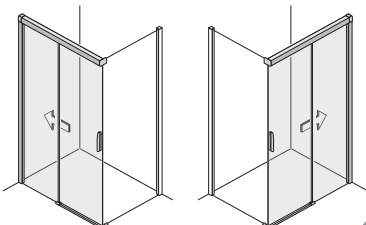
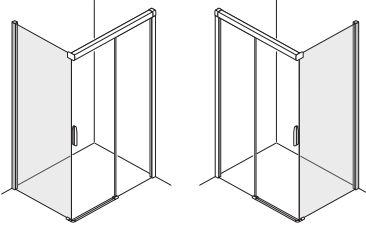
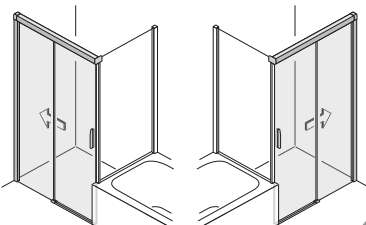
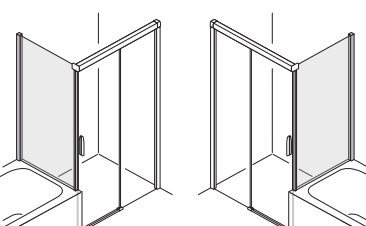
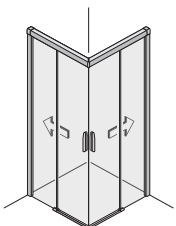
Fixed part left	Fixed part right	Height	Shower tray measurement (WM)	Shower tray installation measurement	Fixed part width	Entrance width
<b>Double sliding door next to side screen</b> 		<b>2000</b>	1000	980 - 1000	452 - 472	395 - 415
1 door part and 1 fixed part			1200	1180 - 1200	552 - 572	495 - 515
			1400	1380 - 1400	652 - 672	595 - 615
<b>CUSTOM MEASUREMENTS</b> - Measurement sketch needed. Height 1800 - 2200 mm. Shower tray installation measurement 1000 - 1600 mm.						
<b>Side screen</b> 		<b>2000</b>	800	780 - 800	-	-
1 door part and 1 fixed part			900	880 - 900	-	-
			1000	980 - 1000	-	-
			1200	1180 - 1200	-	-
<b>CUSTOM MEASUREMENTS</b> - Measurement sketch needed. Height 1800 - 2200 mm. Shower tray installation measurement 500 - 1200 mm. <b>Surcharge for triangular and rectangular cut-outs.</b>						
<b>Double sliding door next to shortened side screen</b> 		<b>2000</b>	1000	980 - 1000	457 - 477	408 - 428
1 door part and 1 fixed part			1200	1180 - 1200	557 - 577	508 - 528
			1400	1380 - 1400	657 - 677	608 - 628
<b>CUSTOM MEASUREMENTS</b> - Measurement sketch needed. Height 1800 - 2200 mm. Shower tray installation measurement 1000 - 1600 mm.						
<b>Shortened side screen</b> 		<b>CUSTOM MEASUREMENTS</b> - Measurement sketch needed. Height 1000 - 2200 mm. Shower tray installation measurement 500 - 1200 mm.			-	-
<b>Surcharge for triangular and rectangular cut-outs.</b>						
<b>Corner entry</b> 		<b>2000</b>	800 × 800	780 - 800	339 - 359	410 - 438
2 Sliding doors and 2 fixed parts			900 × 900	880 - 900	389 - 409	480 - 508
			900 × 800	880 - 900 × 780 - 800	389 - 409 × 339 - 359	445 - 473
			800 × 900	780 - 800 × 880 - 900	339 - 359 × 389 - 409	445 - 473
			1000 × 1000	980 - 1000	439 - 459	550 - 578
			1200 × 1200	1180 - 1200	539 - 559	690 - 718
		<b>CUSTOM MEASUREMENTS</b> - Measurement sketch needed. Height 1800 - 2200 mm. Shower tray installation measurement 700 - 1200 mm.				

**IMPORTANT**

- Required installation height is total height + 100 mm.

Art. no.		Frame colour			Glazing		Glass finishing (optional)	Comfort system
MG								
Base price					Surcharge			
left	right	MH High-gloss metal	WS White SM Matt black LB Silver	WM Matt white GF Graphite metallic CN Champagne MK Mokka BZ Bronze . . . Additional colours	EK Glass clear RW Strip Satin SA Satin	C ARTCLEAR GLAZING	S SOFT OPEN SOFT CLOSE	
MG21 69	MG22 69	1,331	1,556	1,791	EK 0			
MG21 B9	MG22 B9	1,389	1,614	1,849	RW 259	211	116	
MG21 E9	MG22 E9	1,450	1,675	1,910	SA 388			
MG21 88	MG22 88	1,595	1,820	2,055				
MG11 49	MG12 49	711	734	745	EK 0			
MG11 59	MG12 59	737	760	771	RW 204	211	-	
MG11 69	MG12 69	766	789	800	SA 351			
MG11 B9	MG12 B9	847	870	881				
MG11 88	MG12 88	931	954	965				
		322	322	322				
MG31 69	MG32 69	1,418	1,643	1,878	EK 0			
MG31 B9	MG32 B9	1,478	1,703	1,938	RW 259	211	116	
MG31 E9	MG32 E9	1,537	1,762	1,997	SA 388			
MG31 88	MG32 88	1,691	1,916	2,151				
MG61 88	MG62 88	931	954	965	EK 0	211	-	
		322	322	322	RW 204			
					SA 351			
MGE0 49		1,866	2,091	2,326	EK 0	417	232	
MGE0 59					RW 518			
MGE0 99					SA 692			
MGE0 79								
MGE0 69		1,896	2,121	2,356				
MGE0 B9		2,088	2,313	2,548				
MGE0 88		2,298	2,523	2,758				

### IMPORTANT

- When ordering please indicate assembly on shower tray or flush with floor.

# Artweger MOVE sliding door frameless

6 mm ESG

ARTWEGER price list 03/2023. For specialised trade outlets only. Suggested retail prices in EUR not including VAT.  
DIMENSIONS IN MILLIMETRES.

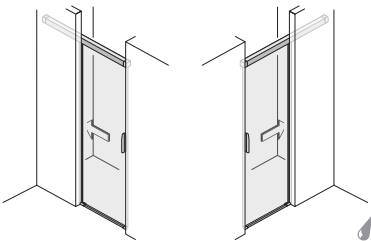
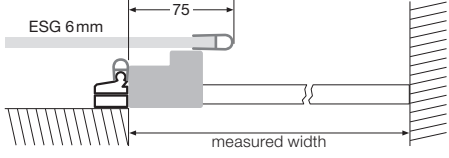
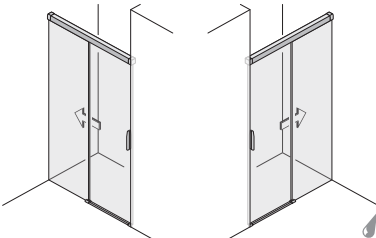
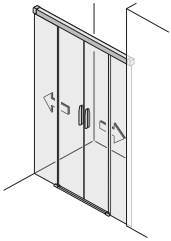
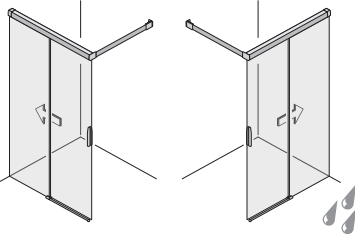
Fixed part left	Fixed part right	Height	Shower tray measurement (WM)	Width	Fixed part width	Entrance width
<b>Sliding door for partially bricked niche</b>  <p>1 door part inside the shower area</p>		<b>2000</b> 1000 - 1200 1201 - 1400 1401 - 1600		 <p>According to dimension sketch.</p>		
<b>CUSTOM MEASUREMENTS</b> - Measurement sketch needed. Height 1800 - 2200 mm. Shower tray installation measurement 1000 - 1800 mm.						
<b>Double sliding door in alcove</b>  <p>1 door part and 1 fixed part</p>		<b>2000</b> 1000 - 1200 1201 - 1400 1401 - 1600				
<b>CUSTOM MEASUREMENTS</b> - Measurement sketch needed. Height 1800 - 2200 mm. Shower tray installation measurement 1000 - 1800 mm.						
<b>Quadruple sliding door in alcove</b>  <p>2 door parts and 2 fixed parts</p>		<b>2000</b> 1400 - 1600 1601 - 1800 1801 - 2000				
<b>CUSTOM MEASUREMENTS</b> - Measurement sketch needed. Height 1800 - 2200 mm. Shower tray installation measurement 1400 - 2000 mm.						
<b>Double sliding door Walk In</b>  <p>1 door part and 1 fixed part</p>		<b>2000</b> 1000 - 1200 1201 - 1400 1401 - 1600				According to dimension sketch. Incl. stabiliser, length 1250 mm. Length has to be adjusted on site.
<b>CUSTOM MEASUREMENTS</b> - Measurement sketch needed. Height 1800 - 2200 mm. Shower tray installation measurement 1000 - 1600 mm.						

## IMPORTANT

- Required installation height is total height + 100 mm.

Art. no.		Frame colour			Glazing		Glass finishing (optional)	Comfort system
M	R							
Base price					Surcharge			
left	right	MH High-gloss metal	WS White SM Matt black LB Silver	WM Matt white GF Graphite metallic CN Champagne MK Mokka BZ Bronze . . Additional colours	EK Glass clear RW Strip Satin SA Satin	C ARTCLEAR GLAZING	S SOFT OPEN SOFT CLOSE	
MRV1 B9	MRV2 B9	1,544	1,769	2,004	EK 0	211	116	
MRV1 E9	MRV2 E9	1,616	1,841	2,076	RW 204			
MRV1 K9	MRV2 K9	1,712	1,937	2,172	SA 351			
MRV1 88	MRV2 88	1,934	2,159	2,394				
MR51 B9	MR52 B9	1,688	1,913	2,148	EK 0	211	116	
MR51 E9	MR52 E9	1,760	1,985	2,220	RW 259			
MR51 K9	MR52 K9	1,856	2,081	2,316	SA 388			
MR51 88	MR52 88	2,153	2,378	2,613				
MRD0 K9		2,513	2,738	2,973	EK 0	417	232	
MRD0 P9		2,586	2,811	3,046	RW 461			
MRD0 U9		2,828	3,053	3,288	SA 692			
MRD0 88		3,195	3,420	3,655				
MRF1 B9	MRF2 B9	1,735	1,960	2,195	EK 0	256	116	
MRF1 E9	MRF2 E9	1,807	2,032	2,267	RW 259			
MRF1 K9	MRF2 K9	1,882	2,107	2,342	SA 388			
MRF1 88	MRF2 88	1,933	2,158	2,393				

### IMPORTANT

- When ordering please indicate assembly on shower tray or flush with floor.

# Artweger MOVE sliding door frameless

6 mm ESG

ARTWEGER price list 03/2023. For specialised trade outlets only. Suggested retail prices in EUR not including VAT.  
DIMENSIONS IN MILLIMETRES.

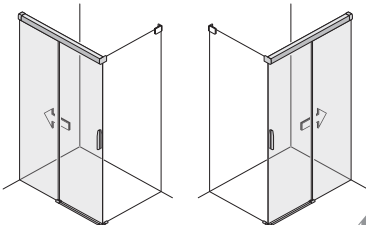
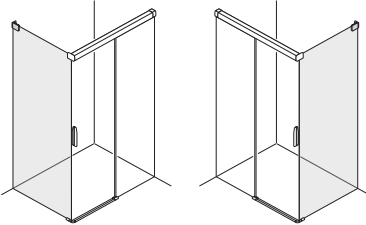
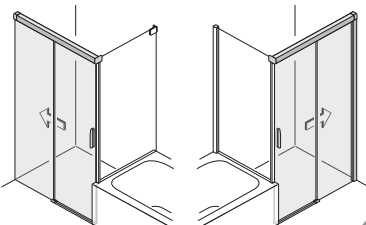
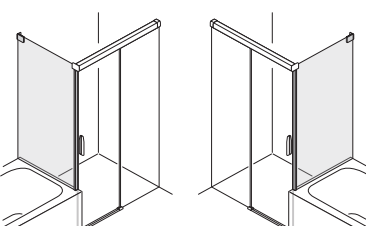
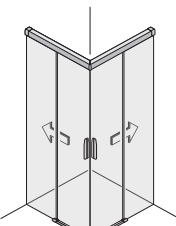
Fixed part left	Fixed part right	Height	Shower tray measurement (WM)	Width	Fixed part width	Entrance width
<b>Double sliding door next to side screen</b> 		2000	1000 - 1200 1201 - 1400	According to dimension sketch.		
1 door part and 1 fixed part <b>CUSTOM MEASUREMENTS</b> - Measurement sketch needed. Height 1800 - 2200 mm. Shower tray installation measurement 1000 - 1600 mm.						
<b>Side screen</b> 		2000	800 - 1000 1001 - 1200	According to dimension sketch.		
<b>CUSTOM MEASUREMENTS</b> - Measurement sketch needed. Height 1800 - 2200 mm. Shower tray installation measurement 500 - 1200 mm. <b>Surcharge for triangular and rectangular cut-outs.</b>						
<b>Double sliding door next to shortened side screen</b> 		2000	1000 - 1200 1201 - 1400	According to dimension sketch.		
1 door part and 1 fixed part <b>CUSTOM MEASUREMENTS</b> - Measurement sketch needed. Height 1800 - 2200 mm. Shower tray installation measurement 1000 - 1600 mm.						
<b>Shortened side screen</b> 		<b>CUSTOM MEASUREMENTS</b> - Measurement sketch needed. Height 1000 - 2200 mm. Shower tray installation measurement 500 - 1200 mm.				
<b>Corner entry</b> 		2000	800 - 1000 × 800 - 1000 1001 - 1200 × 1001 - 1200	According to dimension sketch.		
2 Sliding doors and 2 fixed parts <b>CUSTOM MEASUREMENTS</b> - Measurement sketch needed. Height 1800 - 2200 mm. Shower tray installation measurement 700 - 1200 mm.						

## IMPORTANT

- Required installation height is total height + 100 mm.

Art. no.		Frame colour			Glazing		Glass finishing (optional)	Comfort system
M	R							
Base price					Surcharge			
left	right	MH High-gloss metal	WS White SM Matt black LB Silver	WM Matt white GF Graphite metallic CN Champagne MK Mokka BZ Bronze . . . Additional colours	EK Glass clear RW Strip Satin SA Satin	C ARTCLEAR GLAZING	S SOFT OPEN SOFT CLOSE	
MR21 B9	MR22 B9	1,669	1,894	2,129	EK 0	211	116	
MR21 E9	MR22 E9	1,740	1,965	2,200	RW 259 SA 388			
MR21 88	MR22 88	1,966	2,191	2,426				
MR11 69	MR12 69	885	908	919	EK 0	211	-	
MR11 B9	MR12 B9	1,017	1,040	1,051	RW 204 SA 351			
MR11 88	MR12 88	1,116	1,139	1,150				
		275	275	275				
MR31 B9	MR32 B9	1,775	2,000	2,235	EK 0	211	116	
MR31 E9	MR32 E9	1,845	2,070	2,305	RW 259 SA 388			
MR31 88	MR32 88	2,085	2,310	2,545				
MR61 88	MR62 88	1,116	1,139	1,150	EK 0	211	-	
					RW 204 SA 351			
		275	275	275				
MRE0 69		2,275	2,500	2,735	EK 0	417	232	
MRE0 B9		2,506	2,731	2,966	RW 518 SA 692			
MRE0 88		2,857	3,082	3,317				

### IMPORTANT

- When ordering please indicate assembly on shower tray or flush with floor.

# LIFELINE and LIFELINE MOBIL

## Sliding doors

- Framed design for the best stability
- Frameless swing-out sliding door parts
- Ball-bearing and spring-loaded carriers
- Generous adjustment range 30 mm
- Concealed vertical silicone joints
- 6 mm single-pane safety glass
- Standard height 1900 or 1930 mm
- Custom sizes available
- MOBIL: standard height 1930 - 2080 mm
- MOBIL: customized solutions
- MOBIL: grab poles for more safety
- MOBIL: barrier-free, also suitable for wheelchair users



Artweger®

artclear  
GLASS

CE

according to EN 14428



Sliding-door handle



Easy care of shower



LIFELINE MOBIL  
Grab poles



SPRING-LOADED BALL-BEARING roller system. For especially soft and smooth opening and closing of the sliding doors.

The EXTRA-WIDE BARRIER-FREE entrance ensures greatest comfort. The LIFELINE MOBIL models were developed for barrier-free installation. Due to the access with no sill water can escape. We therefore recommend installing a shower gutter. **Installing on a shower tray is not recommended.**

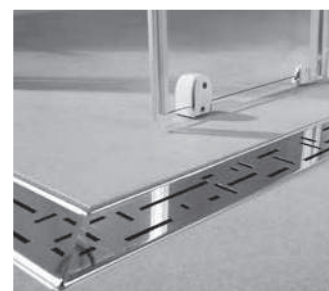

IMPORTANT



# ACCESSORIES

ARTWEGER price list 03/2023. For specialised trade outlets only.  
Suggested retail prices in EUR not including VAT. DIMENSIONS IN MILLIMETRES.

Art. no.				Colour	
L					

Base price

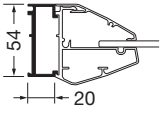
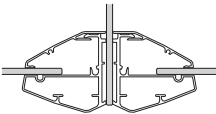
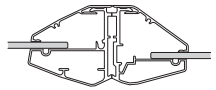
	Height	Art. no.	WS White LB Silver . . Additional colours	MH High-gloss metal
 <p><b>Compound bracket 20 mm</b> Extends adjustment range of all products by 20 mm. In combination with side screen there is a height difference of 30 mm.</p>	1500	<b>LP 12</b>	115	132
	1650	<b>LP 1A</b>	122	140
	1900	<b>LP 17</b>	141	162
	Custom size	<b>LP 18</b>	168	193
 <p><b>Combination of showers in a row</b> Attachment is without additional profile. The two doors are attached directly by means of the glass pane of the side screen which is manufactured exactly to measure. The custom price is valid for the side screen. Necessary additional information: measurement sketch.</p>	Custom size	-	-	-
 <p><b>Combination of door flush with side screen.</b> Connects without additional bracket. Necessary additional information: measurement sketch.</p>	Custom size	-	-	-

## IMPORTANT

- We will gladly send you the documents in hard copy on request.

ARTWEGER price list 03/2023. For specialised trade outlets only. Suggested retail prices in EUR not including VAT.  
DIMENSIONS IN MILLIMETRES.

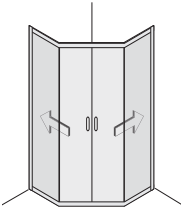
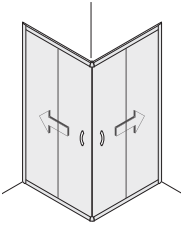
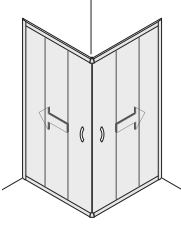
	Height	Shower tray measurement (WM) length a x width b	Shower tray installation measurement	Fixed part width	Entrance width
<b>Pentagonal shower</b>  2 sliding doors and 2 fixed parts	<b>1900</b>	900 x 900 I M=707	875 - 905	350 - 380	460 - 510
		900 x 900 II M=600	875 - 905	420 - 450	420
		900 x 900 IV M=636	875 - 905	400 - 430	460
		900 x 800 I M=707	875 - 905 x 775 - 805	350 - 380 x 250 - 280	350 - 400
		1000 x 1000 I M=707	975 - 1005	450 - 480	510
		1000 x 1000 IV M=630,6	975 - 1005	500 - 530	460
		<b>CUSTOM MEASUREMENTS</b> - Measurement sketch needed. fixed-part custom width (narrower or wider) per side. Surcharge for custom heights up to a maximum of 2000 mm. Wider than 300 mm (11.8 in.) on request.			
<b>Corner entry</b>  2 sliding doors and 2 fixed parts	<b>1900</b>	750 x 750	725 - 755	310 - 340	360 - 400
		800 x 800	775 - 805	340 - 370	400 - 440
		900 x 900	875 - 905	390 - 420	470 - 510
		1000 x 1000	975 - 1005	440 - 470	540 - 580
		left 800 x 750 right	775 - 805 x 725 - 755	340 - 370 x 310 - 340	380 - 420
		900 x 750	875 - 905 x 725 - 755	390 - 420 x 310 - 340	420 - 460
		900 x 800	875 - 905 x 775 - 805	390 - 420 x 340 - 370	430 - 470
		1000 x 700	975 - 1005 x 675 - 705	440 - 470 x 290 - 320	440 - 480
		1000 x 800	975 - 1005 x 775 - 805	440 - 470 x 340 - 370	470 - 510
		<b>CUSTOM MEASUREMENTS</b> - Measurement sketch needed. Height 1500 - 2000 mm. Shower tray installation measurement 750 - 1250 mm. Price for combination of custom and standard measurement: (custom price + standard price) / 2.			
<b>Corner entry</b>  4 sliding doors and 2 fixed parts	<b>1930</b>	700 x 700	675 - 705	200 - 230	430 - 470
		750 x 750	725 - 755	220 - 250	480 - 520
		800 x 800	775 - 805	240 - 270	530 - 570
		900 x 900	875 - 905	270 - 300	620 - 660
		1000 x 1000	975 - 1005	300 - 330	710 - 760
		left 800 x 750 right	775 - 805 x 725 - 755	240 - 270 x 220 - 250	500 - 540
		900 x 750	875 - 905 x 725 - 755	270 - 300 x 220 - 250	560 - 600
		900 x 800	875 - 905 x 775 - 805	270 - 300 x 240 - 270	580 - 620
		1000 x 700	975 - 1005 x 675 - 705	300 - 330 x 200 - 230	590 - 630
		1000 x 800	975 - 1005 x 775 - 805	300 - 330 x 240 - 270	630 - 670
<b>CUSTOM MEASUREMENTS</b> - Measurement sketch needed. Height 1500 - 2030 mm. Shower tray installation measurement 700 - 1100 mm. Price for combination of custom and standard measurement: (custom price + standard price) / 2.					

Art. no.		Frame colour	Glazing	Glass finishing (optional)	Handle colour	
L						
Base price			Surcharge			
WM	Art. no.	WS White LB Silver . . Additional colours	MH High-gloss metal	EK Glass clear SA Satin	C ARTCLEAR GLAZING	. . same as frame <sup>1</sup> VC Chrome
900I	<b>LF 57</b>	2,825	-	EK 0 SA 677	417	.. 0 VC 0
900II	<b>LF 17</b>					
900IV	<b>LF 37</b>					
900/800I	<b>LF 77</b>					
1000I	<b>LF 67</b>					
1000IV	<b>LF 97</b>	3,050	-			
	<b>LF 88</b>	3,369	-			
		469	-			
750	<b>L5 37</b>	2,292	2,636	EK 0 SA 692	417	.. 0 VC 0
800	<b>L5 47</b>					
900	<b>L5 57</b>	2,434	2,799	EK 0 SA 692	417	.. 0 VC 0
1000	<b>L5 67</b>					
800/750	<b>L5 B7</b>					
900/750	<b>L5 C7</b>					
900/800	<b>L5 D7</b>					
1000/700	<b>L5 A7</b>					
1000/800	<b>L5 E7</b>					
	<b>L5 88</b>	2,979	-			
700	<b>L3 17</b>	2,837	3,263	EK 0 SA 692	417	.. 0 VC 0
750	<b>L3 37</b>					
800	<b>L3 47</b>					
900	<b>L3 57</b>	2,982	3,429	EK 0 SA 692	417	.. 0 VC 0
1000	<b>L3 67</b>					
800/750	<b>L3 B7</b>					
900/750	<b>L3 C7</b>					
900/800	<b>L3 D7</b>					
1000/700	<b>L3 A7</b>					
1000/800	<b>L3 E7</b>					
	<b>L3 88</b>	3,510	-			

**IMPORTANT**

<sup>1</sup> Only VC chrome-plated available with MH high-gloss metal frames.

ARTWEGER price list 03/2023. For specialised trade outlets only. Suggested retail prices in EUR not including VAT.  
DIMENSIONS IN MILLIMETRES.

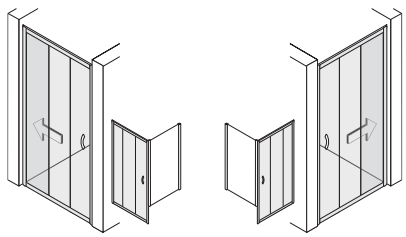
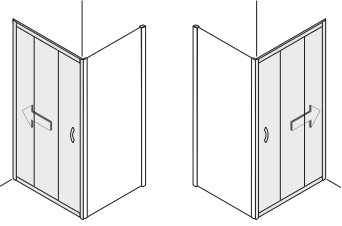
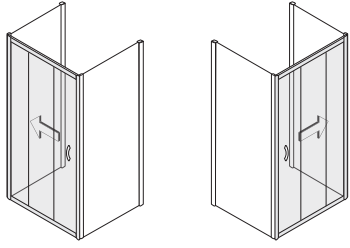
Can be installed so that door opens to left or right.	Height	Shower tray measurement (WM)	Shower tray installation measurement	Fixed part width	Entrance width
<b>Triple sliding door</b> in alcove or with shorter side screen 	<b>1930*</b>	800	750 - 810	270 - 300	360 - 400
		850	800 - 860	280 - 310	390 - 430
		900	850 - 910	300 - 330	420 - 460
		950	900 - 960	320 - 350	450 - 490
		1000	950 - 1010	330 - 360	490 - 530
		1100	1050 - 1110	370 - 400	550 - 590
		1200	1150 - 1210	400 - 430	620 - 660
<b>CUSTOM MEASUREMENTS</b> - Measurement sketch needed. Height 1500 - 2030 mm. Shower tray installation measurement 700 - 1800 mm.					
<b>Triple sliding door</b> for one side screen 	<b>1930*</b>	800	785 - 845	270 - 300	360 - 400
		850	835 - 895	280 - 310	390 - 430
		900	885 - 945	300 - 330	420 - 460
		950	935 - 995	320 - 350	450 - 490
		1000	985 - 1045	330 - 360	490 - 530
		1100	1086 - 1145	370 - 400	550 - 590
		1200	1185 - 1245	400 - 430	620 - 660
<b>CUSTOM MEASUREMENTS</b> - Measurement sketch needed. Height 1500 - 2030 mm. Shower tray installation measurement 700 - 1800 mm.					
<b>Triple sliding door</b> for two side screens 	<b>1930*</b>	800	800 - 860	270 - 300	360 - 400
		850	850 - 910	280 - 310	390 - 430
		900	900 - 960	300 - 330	420 - 460
		950	950 - 1010	320 - 350	450 - 490
		1000	1000 - 1060	330 - 360	490 - 530
		1100	1100 - 1160	370 - 400	550 - 590
		1200	1200 - 1260	400 - 430	620 - 660
<b>CUSTOM MEASUREMENTS</b> - Measurement sketch needed. Height 1500 - 2030 mm. Shower tray installation measurement 700 - 1800 mm.					

2 door parts and 1 fixed part

**Triple sliding door** for one side screen

2 door parts and 1 fixed part

**Triple sliding door** for two side screens

2 door parts and 1 fixed part

Art. no.		Frame colour	Glazing	Glass finishing (optional)	Handle colour	
L						
Base price			Surcharge			
WM	Art. no.	WS White LB Silver . . Additional colours	MH High-gloss metal	EK Glass clear SA Satin	C ARTCLEAR GLAZING	. . same as frame <sup>1</sup> VC Chrome
800	L947	1,451	1,669			
850	L977	1,532	1,762	EK 0 SA 351	211	.. 0 VC 0
900	L957					
950	L997					
1000	L967					
1100	L907	2,017	2,320			
1200	L9B7					
	L988	2,313	-			
800	L947	1,451	1,669			
850	L977	1,532	1,762	EK 0 SA 351	211	.. 0 VC 0
900	L957					
950	L997					
1000	L967					
1100	L907	2,017	2,320			
1200	L9B7					
	L988	2,313	-			
800	L947	1,451	1,669			
850	L977	1,532	1,762	EK 0 SA 351	211	.. 0 VC 0
900	L957					
950	L997					
1000	L967					
1100	L907	2,017	2,320			
1200	L9B7					
	L988	2,313	-			

### IMPORTANT

- Can be installed so that door opens to left or right.
- <sup>1</sup> Only VC chrome-plated available with MH high-gloss metal frames.

ARTWEGER price list 03/2023. For specialised trade outlets only. Suggested retail prices in EUR not including VAT.  
DIMENSIONS IN MILLIMETRES.

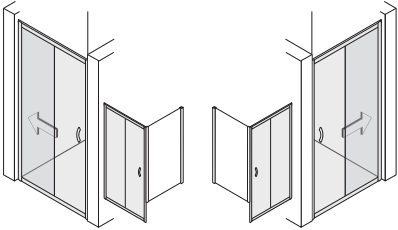
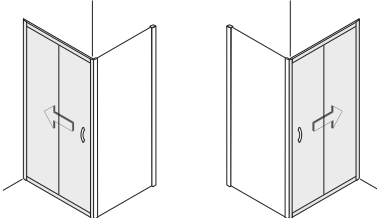
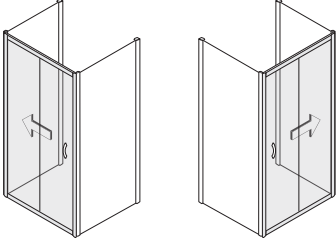
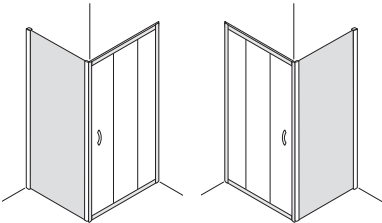
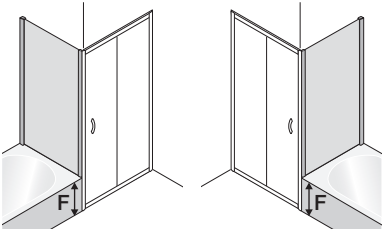
Can be installed so that door opens to left or right.	Height	Shower tray measurement (WM)	Shower tray installation measurement	Fixed part width	Entrance width
<b>Double sliding door</b> in alcove or with shorter side screen 	<b>1900</b>	1200	1150 - 1210	570 - 600	440 - 480
		1300	1250 - 1310	620 - 650	490 - 530
		1400	1350 - 1410	670 - 700	540 - 580
	<b>CUSTOM MEASUREMENTS</b> - Measurement sketch needed. Height 1500 - 2000 mm. Shower tray installation measurement 1200 - 1500 mm.				
1 door part and 1 fixed part					
<b>Double sliding door</b> for one side screen 	<b>1900</b>	1200	1185 - 1245	570 - 600	440 - 480
		1300	1285 - 1345	620 - 650	490 - 530
		1400	1385 - 1445	670 - 700	540 - 580
	<b>CUSTOM MEASUREMENTS</b> - Measurement sketch needed. Height 1500 - 2000 mm. Shower tray installation measurement 1200 - 1500 mm.				
1 door part and 1 fixed part					
<b>Double sliding door</b> for two side screens 	<b>1900</b>	1200	1200 - 1260	570 - 600	440 - 480
		1300	1300 - 1360	620 - 650	490 - 530
		1400	1400 - 1460	670 - 700	540 - 580
	<b>CUSTOM MEASUREMENTS</b> - Measurement sketch needed. Height 1500 - 2000 mm. Shower tray installation measurement 1200 - 1500 mm.				
1 door part and 1 fixed part					
<b>Side screen</b> 	<b>1900</b>	700	680 - 705	-	-
		750	730 - 755	-	-
		800	780 - 805	-	-
		900	880 - 905	-	-
		1000	980 - 1005	-	-
<b>CUSTOM MEASUREMENTS</b> - Measurement sketch needed. Height 1000 - 2000 mm. Shower tray installation measurement 300 - 1000 mm. <b>Surcharge for triangular and rectangular cut-outs.</b>					
<b>Shortened side screen</b> 	<b>CUSTOM MEASUREMENTS</b> - Measurement sketch needed. Height 1000 - 2000 mm. Shower tray installation measurement 300 - 1000 mm. With short side screen always state height difference between shower tray and bathtub (dimension F).				
	<b>Surcharge for triangular and rectangular cut-outs.</b>				

Art. no.		Frame colour	Glazing	Glass finishing (optional)	Handle colour	
L						
Base price			Surcharge			
WM	Art. no.	WS White LB Silver . . Additional colours	MH High-gloss metal	EK Glass clear SA Satin	C ARTCLEAR GLAZING	. . same as frame <sup>1</sup> VC Chrome
1200	L2 B7	1,919	2,207	EK 0 SA 351	211	. . 0 VC 0
1300	L2 D7					
1400	L2 E7					
	L2 88	2,258	-			
1200	L2 B7	1,919	2,207	EK 0 SA 351	211	. . 0 VC 0
1300	L2 D7					
1400	L2 E7					
	L2 88	2,258	-			
1200	L2 B7	1,919	2,207	EK 0 SA 351	211	. . 0 VC 0
1300	L2 D7					
1400	L2 E7					
	L2 88	2,258	-			
700	L1 17	810	932	EK 0 SA 351	211	-
750	L1 37					
800	L1 47					
900	L1 57	900	1,035			
1000	L1 67					
	L1 88	1,103	-			
		220	-			
	L1 88	1,103	1,268	EK 0 SA 351	211	-
		220	-			

LIFELINE









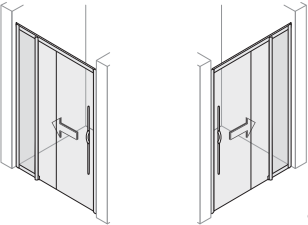

## IMPORTANT

<sup>1</sup> Only VC chrome-plated available with MH high-gloss metal frames.

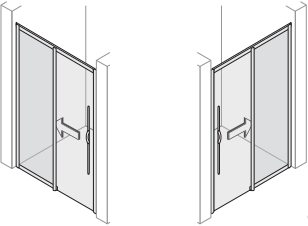
# LIFELINE Mobil

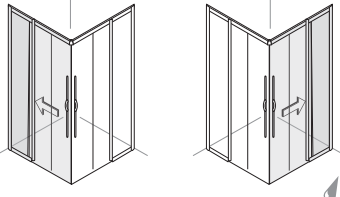
Sliding door 6 mm ESG

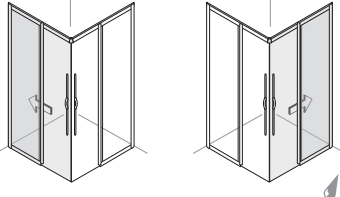
ARTWEGER price list 03/2023. For specialised trade outlets only. Suggested retail prices in EUR not including VAT.  
DIMENSIONS IN MILLIMETRES.

Fixed part left	Fixed part right	Height	Width	Fixed part width	Entrance width
<b>Quadruple sliding door</b> 		<b>1930 - 2080</b>	1400	410 - 440	510 - 570
2 door parts and 2 fixed parts 			1401 - 1600	460 - 490	510 - 670
			1601 - 1800	510 - 540	610 - 770
			1801 - 2000	560 - 590	710 - 870
			2001 - 2500	690 - 720	810 - 1120
		<b>A shower gutter is required.</b> State desired measurements when ordering. Combination with side screen on request.			
<b>Triple sliding door</b> 		<b>1930 - 2080</b>	1000	330 - 360	490 - 530
2 door parts and 1 fixed part 			1001 - 1200	400 - 430	490 - 660
			1201 - 1400	460 - 490	620 - 800
			1401 - 1600	530 - 560	760 - 930
			1601 - 1800	600 - 630	890 - 1060
			1801 - 2000	670 - 700	1020 - 1200
					<b>A shower gutter is required.</b> State desired measurements when ordering. Combination with side screen on request.
<b>Double sliding door</b> 		<b>1930 - 2080</b>	1200	570 - 600	440 - 480
1 door part and 1 fixed part 			1201 - 1400	670 - 700	440 - 580
			1401 - 1600	770 - 800	540 - 680
			1601 - 1800	870 - 900	640 - 780
			1801 - 2000	970 - 1000	740 - 880
					<b>A shower gutter is required.</b> State desired measurements when ordering. Combination with side screen on request.
<b>Triple corner-entry half</b> 		<b>1930 - 2080</b>	801 - 1000	300 - 330	520 - 750
2 door parts and 1 fixed part 			1001 - 1200	370 - 400	710 - 940
			1201 - 1400	440 - 470	900 - 1130
					<b>A shower gutter is required.</b> State desired measurements when ordering.
<b>Double corner-entry half</b> 		<b>1930 - 2080</b>	801 - 1000	440 - 470	410 - 590
1 door part and 1 fixed part 			1001 - 1200	540 - 570	550 - 730
			1201 - 1400	640 - 670	690 - 870
			1401 - 1600	740 - 770	830 - 1010
					<b>A shower gutter is required.</b> State desired measurements when ordering.

## IMPORTANT

- The EXTRA-WIDE BARRIER-FREE entrance ensures greatest comfort. The LIFELINE MOBIL models were developed for barrier-free installation. Due to the access with no sill water can escape. We therefore recommend installing a shower gutter.
  - LIFELINE MOBIL shower enclosures are adapted exactly to the individual installation situation.
- Exact measurements including sketch required. Execution without lower floor rail in the entry area. In the door area between door and floor there is a gap of approx. 15 mm to the lower edge of the glass and approx. 3 mm to the lower edge of the sealing rim. A shower gutter is required.



Art. no.		Frame colour		Glazing		Glass finishing (optional)	Handle colour	
L								
Base price				Surcharge				
Fixed part left	Fixed part right	WS White LB Silver . . Additional colours	MH High-gloss metal	EK Glass clear SA Satin	C ARTCLEAR GLAZING	. . same as frame <sup>1</sup> LB Silver		
LBD0 E8		3,113	3,580					
LBD0 K8		3,225	3,709					
LBD0 P8		3,231	3,716	EK 0		417	.. 0	
LBD0 U8		3,237	3,723	SA 677			LB 0	
LBD0 X8		3,652	4,200					
LB91 68	LB92 68	2,652	3,050					
LB91 B8	LB92 B8	2,715	3,122					
LB91 E8	LB92 E8	2,859	3,288	EK 0		417	.. 0	
LB91 K8	LB92 K8	3,062	3,521	SA 677			LB 0	
LB91 P8	LB92 P8	3,188	3,666					
LB91 U8	LB92 U8	3,311	3,808					
LB21 B8	LB22 B8	2,498	2,873					
LB21 E8	LB22 E8	2,560	2,944					
LB21 K8	LB22 K8	2,616	3,008	EK 0		417	.. 0	
LB21 P8	LB22 P8	2,681	3,083	SA 677			LB 0	
LB21 U8	LB22 U8	2,741	3,152					
LB31 68	LB32 68	2,227	2,561					
LB31 B8	LB32 B8	2,285	2,628	EK 0		211	.. 0	
LB31 E8	LB32 E8	2,330	2,680	SA 345			LB 0	
The prices apply to one corner-entry half respectively. For the total price add the prices of the individual halves together.								
LB51 68	LB52 68	2,009	2,310					
LB51 B8	LB52 B8	2,068	2,378					
LB51 E8	LB52 E8	2,130	2,450	EK 0		211	.. 0	
LB51 K8	LB52 K8	2,191	2,520	SA 345			LB 0	
The prices apply to one corner-entry half respectively. For the total price add the prices of the individual halves together.								

**IMPORTANT**

- The wheelchair suitability depends on the applicable standard or individual requirements.
- Installing on a shower tray is not recommended.
- Synthetic parts in white.

<sup>1</sup> Only LB silver available with MH high-gloss metal frames.

\* In combination with side screen there is a height difference of 30 mm.

# Artweger SLIDE

Opens new perspectives

- Sliding doors
- Can be swung out for easy cleaning
- Fixed overflow moulding in the door area
- Incl. ARTCLEAN glass coating without surcharge
- 6 mm single-pane safety glass
- Height 2000 mm



Especially practical: The door elements can be swung out at the bottom to enable easier cleaning.



Behind the stylish wall profiles there is room for an adjustment range of up to 15 mm. This enables the Artweger SLIDE to also be mounted on sloping/uneven walls.



**Artweger®**



according to EN 14428

## HANDLES



Modern yet impermeable. Floor profiles for the door ensure smoothness and imperviousness. The frameless glass panels create a dynamic appearance.



# Artweger SLIDE PROMPT DELIVERY

ARTWEGER price list 03/2023. For specialised trade outlets only. Suggested retail prices in EUR not including VAT.  
DIMENSIONS IN MILLIMETRES.

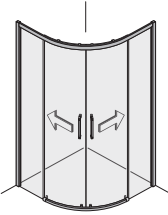
Artweger SLIDE - height 2000 mm	Shower tray measurement (WxM)	Shower tray installation measurement	Entrance-width	Fixed part width	Art. no.	Price in EUR
 <p><b>SLIDE 1/4-round shower</b></p> <p><b>High-gloss metal, glass clear 6 mm with ARTCLEAN coating</b> 2 sliding doors and 2 fixed parts</p>	800 x 800 I	785 - 800	490	295 - 310	<b>VSR 49 MH EK</b>	1,308
	900 x 900 I	885 - 900	490	395 - 410	<b>VSR 19 MH EK</b>	1,371
	900 x 900 II	885 - 900	560	345 - 360	<b>VSR 29 MH EK</b>	1,371
	1000 x 1000 II	985 - 1000	560	445 - 460	<b>VSR 69 MH EK</b>	1,434
Radius I = 500, radius II = 550						

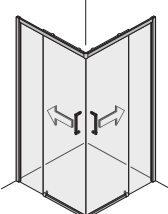
 <p><b>SLIDE Corner entry</b></p> <p><b>High-gloss metal, glass clear 6 mm with ARTCLEAN coating</b> 2 sliding doors and 2 fixed parts</p>	800 x 800	785 - 800	420	345 - 360	<b>VSE 49 MH EK</b>	1,182	
	900 x 900	885 - 900	440	435 - 450	<b>VSE 59 MH EK</b>	1,246	
	900 x 750	885 - 900 735 - 750	410	435 - 450 320 - 335	<b>VSE D9 MH EK</b>	1,182	
	750 x 900	735 - 750 885 - 900	410	320 - 335 435 - 450	<b>VSE C9 MH EK</b>	1,182	
	900 x 800	885 - 900 785 - 800	430	435 - 450 345 - 360	<b>VSE 99 MH EK</b>	1,214	
	800 x 900	785 - 800 885 - 900	430	345 - 360 435 - 450	<b>VSE 79 MH EK</b>	1,214	
	1000 x 1000	985 - 1000	440	535 - 550	<b>VSE 69 MH EK</b>	1,306	
Other size combinations of the above standard sizes are possible.						<b>VSE 89 MH EK</b>	1,306

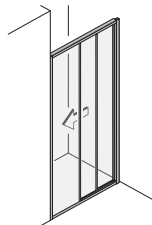
 <p><b>SLIDE Triple sliding door in alcove</b></p> <p><b>High-gloss metal, glass clear 6 mm with ARTCLEAN coating</b> 2 door parts and 1 fixed part</p>	800 left	770 - 800	425	265 - 280	<b>VS9 C9 MH EK</b>	838
	900 left	870 - 900	490	300 - 315	<b>VS9 E9 MH EK</b>	883
	1000 left	970 - 1000	560	330 - 345	<b>VS9 G9 MH EK</b>	928
	800 right	770 - 800	425	265 - 280	<b>VS9 D9 MH EK</b>	838
	900 right	870 - 900	490	300 - 315	<b>VS9 F9 MH EK</b>	883
	1000 right	970 - 1000	560	330 - 345	<b>VS9 H9 MH EK</b>	928

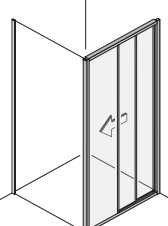
 <p><b>SLIDE Triple sliding door next to side screen</b></p> <p><b>High-gloss metal, glass clear 6 mm with ARTCLEAN coating</b> 2 door parts and 1 fixed part</p>	800 left	785 - 800	425	265 - 280	<b>VS9 C9 MH EK</b>	838
	900 left	885 - 900	490	300 - 315	<b>VS9 E9 MH EK</b>	883
	1000 left	985 - 1000	560	330 - 345	<b>VS9 G9 MH EK</b>	928
	800 right	785 - 800	425	265 - 280	<b>VS9 D9 MH EK</b>	838
	900 right	885 - 900	490	300 - 315	<b>VS9 F9 MH EK</b>	883
	1000 right	985 - 1000	560	330 - 345	<b>VS9 H9 MH EK</b>	928

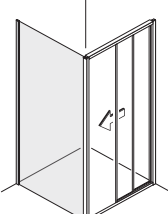
 <p><b>SLIDE Side screen</b></p> <p><b>High-gloss metal, glass clear 6 mm with ARTCLEAN coating</b></p>	800	788 - 800	-	-	<b>VS1 49 MH EK</b>	464
	900	888 - 900	-	-	<b>VS1 59 MH EK</b>	488
	1000	988 - 1000	-	-	<b>VS1 69 MH EK</b>	514
Assembly on the left or right.						

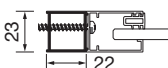
 <p><b>SLIDE Compound bracket 22 mm</b></p> <p><b>High-gloss metal</b> Extends adjustment range of the corner entry and 1/4-round shower by 22 mm. Height 2000 mm.</p>					<b>VS0P 49 MH</b>	83
---	--	--	--	--	-------------------	----

## IMPORTANT

- Required installation height is total height + 50 mm.

# BASELINE

Always well designed

- Sliding doors and swinging doors
- Spring-loaded roller-carriers for sliding doors
- Framed design for the best seal and stability.
- Swing-out sliding doors
- 3 mm single-pane safety glass or synthetic glazing
- Standard height 1850 or 2000 mm
- Generous adjustment range 25 mm
- Custom sizes available



The robust frame combined with heavyduty sealing strips guarantee many years of trouble-free showering pleasure, even under heavy use.



The robust handles lie very well in the hand.



Artweger®

artclear  
GLASS

CE

according to EN 14428

# ACCESSORIES

ARTWEGER price list 03/2023. For specialised trade outlets only.  
Suggested retail prices in EUR not including VAT. DIMENSIONS IN MILLIMETRES.

Art. no.

Colour

G

Base price

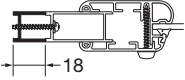
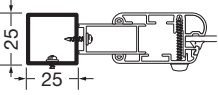
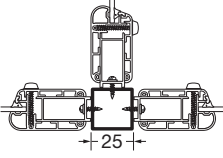
	Height	Art. no.	NX Natural anodised	WS White
 <p><b>Compound bracket 18 mm</b> Extends adjustment range of all products by 18 mm.</p>	1850	<b>GP 1D</b>	103	113
	2000	<b>GP 19</b>	103	113
	Custom size	<b>GP 18</b>	125	138
 <p><b>Mounting bracket 25 x 25 mm</b> For attaching side screens to wall projections. Necessary additional information: measurement sketch.</p>	1850	<b>GP 2D</b>	228	251
	2000	<b>GP 29</b>	228	251
	Custom size	<b>GP 28</b>	273	300
 <p><b>Connection bracket for a row of shower units 25 x 25 mm.</b> For use with triple sliding door. The custom price is valid for the side screen. Necessary additional information: measurement sketch.</p>	1850	<b>GP 3D</b>	228	251
	2000	<b>GP 39</b>	228	251
	Custom size	<b>GP 38</b>	273	300

## IMPORTANT

- We will gladly send you the documents in hard copy on request.

# BASELINE

Sliding door glass thickness 3 mm

ARTWEGER price list 03/2023. For specialised trade outlets only. Suggested retail prices in EUR not including VAT.  
DIMENSIONS IN MILLIMETRES.

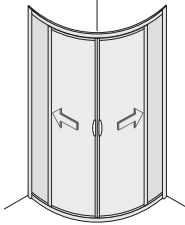
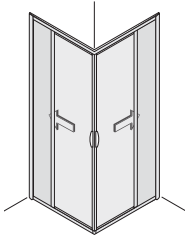
	Height	Shower tray measurement (WM) length a x width b	Shower tray installation measurement	Fixed part width	Entrance width
<b>1/4-round shower</b>  2 sliding doors and 2 fixed parts	<b>1850*</b>	800 x 800 I R=500	780 - 805	275 - 300	460
		900 x 900 I R=500	880 - 905	375 - 400	530
		900 x 900 II R=550	880 - 905	325 - 350	550
		1000 x 1000 II R=550	980 - 1005	425 - 450	600
		900 x 800 I R=500	880 - 905 x 780 - 805	375 - 400 x 275 - 300	500
		Combination with side screen on request.			
<b>CUSTOM MEASUREMENTS</b> - Measurement sketch needed. fixed-part custom width (narrower or wider) per side. Wider than 300 mm (11.8 in.) on request. Custom heights not available.					
<b>Corner entry</b>  2 sliding doors and 2 fixed parts	<b>1850</b>	800 x 800	780 - 805	390 - 415	440
		900 x 900	880 - 905	440 - 465	510
		left 1000 x 1000 right	980 - 1005	490 - 515	580
		900 x 750	880 - 905 x 730 - 755	440 - 465 x 365 - 390	460
		750 x 900	730 - 755 x 880 - 905	365 - 390 x 440 - 465	460
	<b>2000</b>	800 x 800	780 - 805	390 - 415	440
		900 x 900	880 - 905	440 - 465	510
		left 1000 x 1000 right	980 - 1005	490 - 515	580
		900 x 750	880 - 905 x 730 - 755	440 - 465 x 365 - 390	460
		750 x 900	730 - 755 x 880 - 905	365 - 390 x 440 - 465	460
Combination with side screen on request.					
<b>CUSTOM MEASUREMENTS</b> - Measurement sketch needed. Height 1500 - 2000 mm. Shower tray installation measurement 700 - 1200 mm. Price for combination of custom and standard measurement: (custom price + standard price) / 2.					

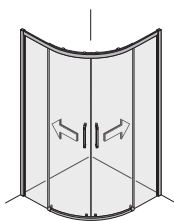

### \*1/4-round shower with sliding doors and height 2000 mm.

On page 157 you can find the Artweger SLIDE 1/4-round shower.  
High-gloss metal and single-pane safety glass 6 mm.

Art. no.	Colour	Glazing	Glass finishing for glass clear
G			
Base price		Surcharge	

WM	Art. no.	NX Natural anodised	WS White	DD Synthetic glazing EK DIAMOND Glass clear	C ARTCLEAR GLAZING
800I	<b>GR 4D</b>	1,667	1,834		
900I	<b>GR 1D</b>	1,695	1,865	<b>DD</b> not available <b>EK</b> 234	417
900II	<b>GR 2D</b>				
1000II	<b>GR 6D</b>	1,830	2,013		
900/800I	<b>GR 9D</b>	1,695	1,865		
	<b>GR 88</b>	1,870	2,057		
800	<b>GE 4D</b>	1,155	1,271		
900	<b>GE 5D</b>	1,181	1,299		
1000	<b>GE 6D</b>	1,210	1,331		
900/750	<b>GE GD</b>	1,178	1,296	<b>DD</b> 0 <b>EK</b> 170	417
750/900	<b>GE HD</b>				
800	<b>GE 49</b>	1,155	1,271		
900	<b>GE 59</b>	1,181	1,299		
1000	<b>GE 69</b>	1,210	1,331		
900/750	<b>GE G9</b>	1,178	1,296		
750/900	<b>GE H9</b>				
	<b>GE 88</b>	1,372	1,509		

# BASELINE

Sliding door / Swinging door glass thickness 3 mm

ARTWEGER price list 03/2023. For specialised trade outlets only. Suggested retail prices in EUR not including VAT.

DIMENSIONS IN MILLIMETRES.

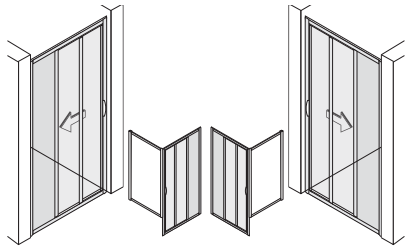
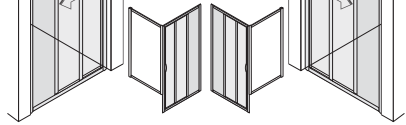
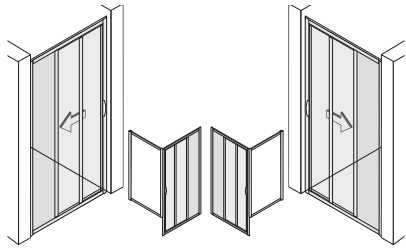
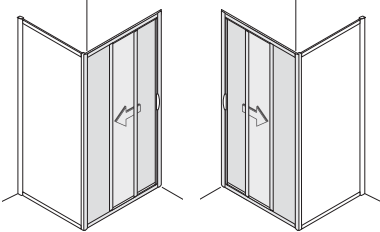
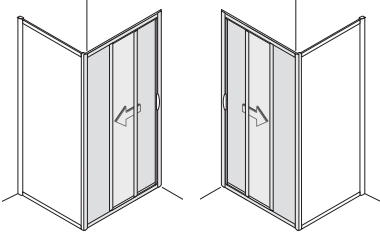
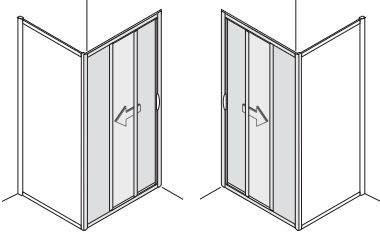
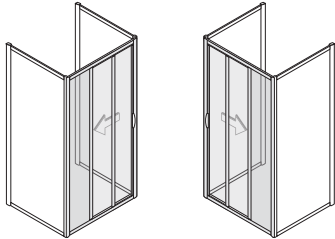
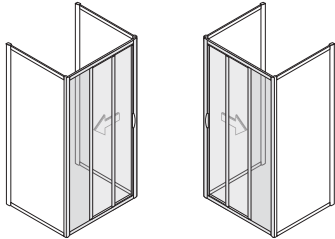
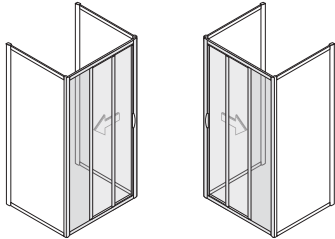
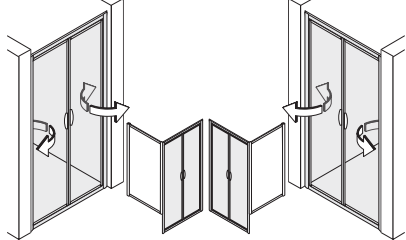
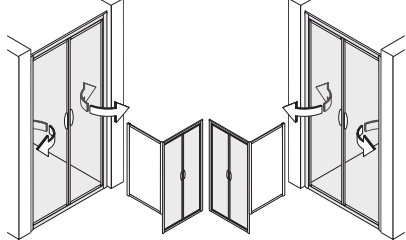
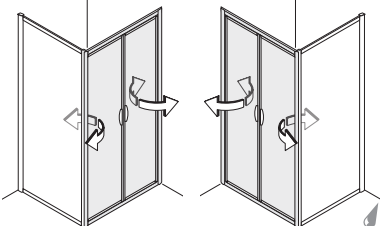
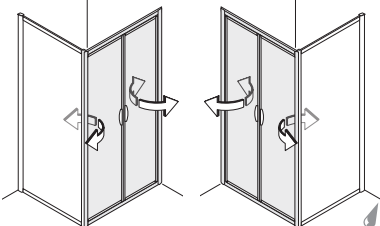
Fixed part left	Fixed part right	Height	Shower tray measurement (WM)	Shower tray installation measurement	Fixed part width	Entrance width
<b>Triple sliding door</b> in alcove or for shortened side screen 		<b>1850</b>	800	760 - 810	280 - 305	380
			900	860 - 910	310 - 335	450
			1000	960 - 1010	345 - 370	520
<b>2 door parts and 1 fixed part</b> 		<b>2000</b>	800	760 - 810	280 - 305	380
			900	860 - 910	310 - 335	450
			1000	960 - 1010	345 - 370	520
<b>CUSTOM MEASUREMENTS</b> - Measurement sketch needed. Height 1500 - 2000 mm. Shower tray installation measurement 800 - 1200 mm. Widths over 1000 mm available only with synthetic glazing.						
<b>Triple sliding door</b> for one side screen 		<b>1850</b>	800	780 - 805	280 - 305	380
			900	880 - 905	310 - 335	450
			1000	980 - 1005	345 - 370	520
<b>2 door parts and 1 fixed part</b> 		<b>2000</b>	800	780 - 805	280 - 305	380
			900	880 - 905	310 - 335	450
			1000	980 - 1005	345 - 370	520
<b>CUSTOM MEASUREMENTS</b> - Measurement sketch needed. Height 1500 - 2000 mm. Shower tray installation measurement 800 - 1200 mm. Widths over 1000 mm available only with synthetic glazing.						
<b>Triple sliding door</b> for two side screens 		<b>1850</b>	800	800 - 835	280 - 305	380
			900	900 - 935	310 - 335	450
			1000	1000 - 1035	345 - 370	520
<b>2 door parts and 1 fixed part</b> 		<b>2000</b>	800	800 - 835	280 - 305	380
			900	900 - 935	310 - 335	450
			1000	1000 - 1035	345 - 370	520
<b>CUSTOM MEASUREMENTS</b> - Measurement sketch needed. Height 1500 - 2000 mm. Shower tray installation measurement 800 - 1200 mm. Widths over 1000 mm available only with synthetic glazing.						
<b>Swinging door</b> in alcove or for shortened side screen 		<b>1850</b>	800	760 - 810	-	610
			900	860 - 910	-	710
		<b>CUSTOM MEASUREMENTS</b> - Measurement sketch needed. Height 1500 - 1850 mm. Shower tray installation measurement 800 - 1100 mm. Widths over 1000 mm available only with synthetic glazing.				
<b>Swinging door</b> for one side screen 		<b>1850</b>	800	780 - 805	-	610
			900	880 - 905	-	710
		<b>CUSTOM MEASUREMENTS</b> - Measurement sketch needed. Height 1500 - 1850 mm. Shower tray installation measurement 800 - 1000 mm.				



Art. no.		Colour		Glazing		Glass finishing for glass clear	
G							
Base price				Surcharge			
WM	Fixed part left	Fixed part right	NX Natural anodised	WS White	DD Synthetic glazing EK DIAMOND Glass clear	C ARTCLEAR GLAZING	
800	<b>G9 CD</b>	<b>G9 DD</b>	756	832	<b>DD</b> <b>EK</b>	0 113	211
900	<b>G9 ED</b>	<b>G9 FD</b>	772	849			
1000	<b>G9 GD</b>	<b>G9 HD</b>	848	933			
800	<b>G9 C9</b>	<b>G9 D9</b>	756	832			
900	<b>G9 E9</b>	<b>G9 F9</b>	772	849			
1000	<b>G9 G9</b>	<b>G9 H9</b>	848	933			
	<b>G9 Y8</b>	<b>G9 Z8</b>	922	1,014			
800	<b>G9 CD</b>	<b>G9 DD</b>	756	832	<b>DD</b> <b>EK</b>	0 113	211
900	<b>G9 ED</b>	<b>G9 FD</b>	772	849			
1000	<b>G9 GD</b>	<b>G9 HD</b>	848	933			
800	<b>G9 C9</b>	<b>G9 D9</b>	756	832			
900	<b>G9 E9</b>	<b>G9 F9</b>	772	849			
1000	<b>G9 G9</b>	<b>G9 H9</b>	848	933			
	<b>G9 Y8</b>	<b>G9 Z8</b>	922	1,014			
800	<b>G9 CD</b>	<b>G9 DD</b>	756	832	<b>DD</b> <b>EK</b>	0 113	211
900	<b>G9 ED</b>	<b>G9 FD</b>	772	849			
1000	<b>G9 GD</b>	<b>G9 HD</b>	848	933			
800	<b>G9 C9</b>	<b>G9 D9</b>	756	832			
900	<b>G9 E9</b>	<b>G9 F9</b>	772	849			
1000	<b>G9 G9</b>	<b>G9 H9</b>	848	933			
	<b>G9 Y8</b>	<b>G9 Z8</b>	922	1,014			
800	<b>G24D</b>		810	891	<b>DD</b> <b>EK</b>	0 113	211
900	<b>G25D</b>		826	909			
	<b>G288</b>		986	1,085			
800	<b>G24D</b>		810	891	<b>DD</b> <b>EK</b>	0 113	211
900	<b>G25D</b>		826	909			
	<b>G288</b>		986	1,085			

# BASELINE

Side screen glass thickness 3 mm

ARTWEGER price list 03/2023. For specialised trade outlets only. Suggested retail prices in EUR not including VAT.  
DIMENSIONS IN MILLIMETRES.

Can be installed on left or right.

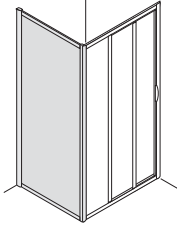
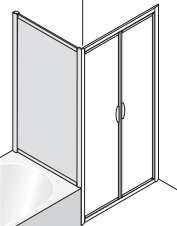
Can be installed on left or right.	Height	Shower tray measurement (WM)	Shower tray installation measurement
<b>Side screen</b> 	<b>1850</b>	800	780 - 805
		900	880 - 905
		1000	980 - 1005
	<b>2000</b>	800	780 - 805
		900	880 - 905
		1000	980 - 1005
<b>CUSTOM MEASUREMENTS</b> - Measurement sketch needed. Height 1850 - 2000 mm. Shower tray installation measurement 300 - 1000 mm.			
<b>Shortened side screen</b> 	<b>CUSTOM MEASUREMENTS</b> - Measurement sketch needed. Height 1000 - 2000 mm. Shower tray installation measurement from 300 up to 1000 mm.		

Art. no.	Colour	Glazing	Glass finishing for glass clear
G			
Base price		Surcharge	

WM	Art. no.	NX Natural anodised	WS White	DD Synthetic glazing EK DIAMOND Glass clear	C ARTCLEAR GLAZING		
800	<b>G1 4D</b>	420	462	DD EK 0 65	211		
900	<b>G1 5D</b>	426	469				
1000	<b>G1 6D</b>	437	481				
800	<b>G1 49</b>	420	462				
900	<b>G1 59</b>	426	469				
1000	<b>G1 69</b>	437	481				
	<b>G1 88</b>	584	642				
	<b>G1 X8</b>	506	557			DD EK 0 65	211

**Did you not find a suitable model?**  
**We have the right solution for your very special wishes for your own bathroom.**  
**Contact us!**  
**ARTWEGER – Your specialist for customized, individual solutions!**

# ARTWEGER 360

Bathtub enclosures

# Anniversary Edition Artweger PRO:TECT

- 180° rotating-cylinder wall connector, 360° TWIN hinges or winged door hinges
- Raise and lower mechanism
- Wall profile with 3D adjustment and concealed silicone joints in models with fixed parts
- 6 mm single-pane safety glass
- Standard height 1500 mm
- Custom sizes available

- **Mounting without drilling**
- 360° TWIN hinges with raise and lower mechanism
- Wall profile with 3D adjustment
- 6 mm single-pane safety glass
- Standard height 1500 mm
- Adjustment range 20 mm
- Custom sizes available



Single part folding door on fixed part (see top fig.) and on extra-wide fixed part.

Artweger

1923 - 2023  
Artweger

artclear  
GLASS



**Mounting without drilling.**  
Quick and safe with adhesive technique.

**Le système de collage ART-FIX** is universally applicable for all substrates that are fully load-bearing, flat, dry, free of dust and grease, sealed against moisture and free of adhesion-reducing substances.

CE

according to EN 14428



Especially EASY TO CLEAN.

In case of the 360° TWIN hinge a second pivot allows the moving element to be opened inwards and outwards.

# Artweger MOVE

Sliding doors on bathtub

- Overhead guided sliding doors
- Framed models including a 20 mm adjustment range
- Frameless models made to measure according to requirements
- 6 mm single-pane safety glass
- Standard height 1500 mm
- Custom sizes available



# BASELINE

Bathtub folding screens

- Folding screens without fixed part
- Framed design for the best stability
- Swings totally away
- 3 mm single-pane safety glass or synthetic glazing
- Standard height 1500 mm
- Adjustment range 25 mm
- Custom sizes available



With SOFT OPEN / SOFT CLOSE (optional) the most up to date technology is hidden behind the elegant inside panel. The door is gently slowed down just before the end and then glides smoothly into the stop position.

Artweger®

artclear  
GLASS



according to EN 14428



The folding screen can be swung out on the 180-degree hinge. For even less work cleaning the BASELINE tub folding screen can also be equipped with ARTCLEAN glass coating on request.



The patent pending magnetic closure enables the door to swing open by lightly pressing it. This makes cleaning much easier.



BASELINE: The BASELINE tub folding screen saves lots of space when folded together.

# ARTWEGER 360 partially framed

Folding screen 6 mm ESG

ARTWEGER price list 03/2023. For specialised trade outlets only. Suggested retail prices in EUR not including VAT.  
DIMENSIONS IN MILLIMETRES.

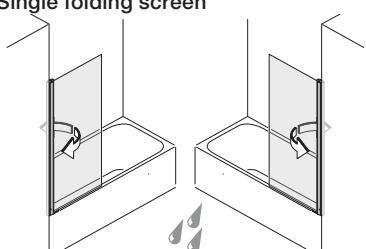
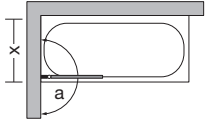
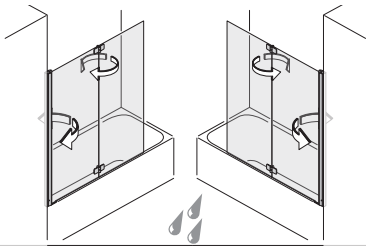
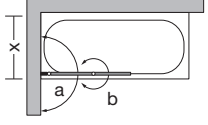
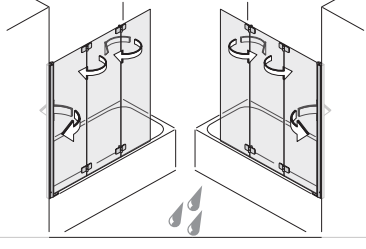
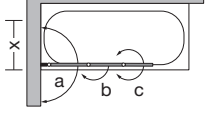
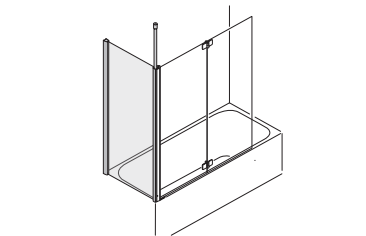
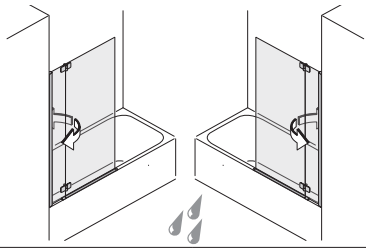
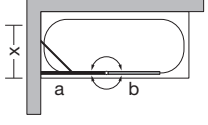
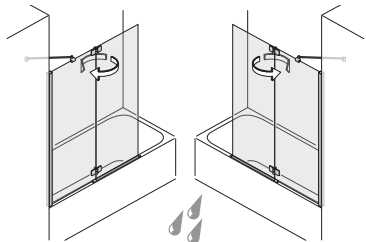
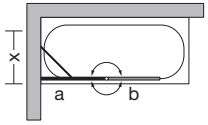
left	right	Height	Bathtub measurement (WM)	Width tub folding screen	Width of folding pieces	
		1500	700	650 - 668	a = 660, x = 675	
			750	700 - 718	a = 710, x = 725	
<p><b>CUSTOM MEASUREMENTS</b> - Measurement sketch needed. Height 1100 - 1600 mm. Width 500 - 950 mm.</p> <p><b>Surcharge for triangular and rectangular cut-outs.</b></p>						
		1500	All sizes	1282 - 1300	a = 700 b = 595 x = 725	
<p>Only watertight when fully extended.</p> <p><b>CUSTOM MEASUREMENTS</b> - Measurement sketch needed. Height 1400 - 1500 mm. Width 1100 - 1300 mm.</p> <p><b>Surcharge for triangular and rectangular cut-outs. Triangular cut-out possible only on last part.</b></p>						
		1500	All sizes	1382 - 1400	a = 545 b = 450 c = 400 x = 570	
<p>Only watertight when fully extended.</p> <p><b>CUSTOM MEASUREMENTS</b> - Measurement sketch needed. Height 1400 - 1500 mm. Width 1100 - 1400 mm.</p> <p><b>Surcharge for triangular and rectangular cut-outs. Triangular cut-out possible only on last part.</b></p>						
		1500	700	682 - 700	-	-
			750	732 - 750	-	-
			800	782 - 800	-	-
<p>Can be combined with single, double and triple folding screen. Ceiling support extendable up to 1000 mm. Assembly without folding screen on request.</p> <p><b>CUSTOM MEASUREMENTS</b> - Measurement sketch needed. Height 1400 - 1500 mm. Shower tray installation measurement 300 - 900 mm.</p>						
		1500	All sizes	880 - 900	a = 235 b = 660 x = 710	
<p>Cannot be combined with a side screen.</p> <p><b>CUSTOM MEASUREMENTS</b> - Measurement sketch needed. Height 1400 - 1700 mm. Overall width 900 - 1200 mm, moving element max. 650 mm.</p> <p><b>Surcharge for triangular and rectangular cut-outs.</b></p>						
		1500	All sizes	1180 - 1200	a = 635 b = 560 x = 610	
<p>Incl. stabiliser. Cannot be combined with a side screen.</p> <p><b>CUSTOM MEASUREMENTS</b> - Measurement sketch needed. Height 1400 - 1700 mm. Overall width 1200 - 1400 mm, moving element max. 650 mm.</p> <p><b>Surcharge for triangular and rectangular cut-outs.</b></p>						

**IMPORTANT**

- Double folding screen and triple folding screen: not suitable for use on corner bathtubs.
- Folding screen, side screen: Required installation height is total height + 250 mm.

Art. no.		Frame colour	Glazing	Glass finishing (optional)	Hinge colour	
9 T						
Base price			Surcharge			
WM	left	right	MH High-gloss metal WS White/chrome . . Additional colours	EK Glass clear RW Strip Satin	C ARTCLEAR GLAZING	. . same as frame <sup>1</sup> VC Chrome
700	9TKK1 12	9TKK2 12	1,223	EK 0 RW 259	211	0
750	9TKK1 32	9TKK2 32	1,286			
	9TKK1 18	9TKK2 18	1,455			
			275			
	9TKK1 52	9TKK2 52	1,654	EK 0 RW 259	211	0
	9TKK1 58	9TKK2 58	1,919			
			275			
	9TKK1 72	9TKK2 72	2,194	EK 0 RW 351	211	0
	9TKK1 78	9TKK2 78	2,609			
			275			
700	9T6K0 12		802	EK 0 RW 204	211	-
750	9T6K0 32		849			
800	9T6K0 42					
	9T6K0 88		989			
	9TKP1 52	9TKP2 52	1,218	EK 0 RW 259	211	0
	9TKP1 88	9TKP2 88	1,304			
			275			
	9TKP3 B2	9TKP4 B2	1,366	EK 0 RW 259	211	0
	9TKP3 88	9TKP4 88	1,460			
			275			

**IMPORTANT**

- Folding screen attached on fixed part: Required installation height is total height + 30 mm.
- <sup>1</sup> Only VC chrome-plated available with MH high-gloss metal frames.

# Anniversary Edition Artweger PRO:TECT

Folding screen 6 mm ESG

ARTWEGER price list 03/2023. For specialised trade outlets only. Suggested retail prices in EUR not including VAT.  
DIMENSIONS IN MILLIMETRES.

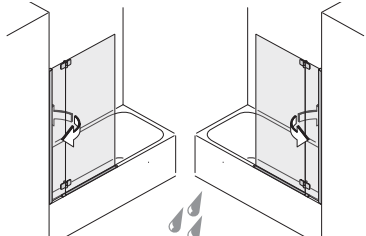
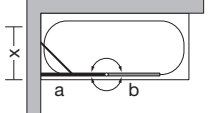
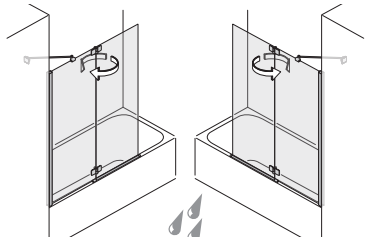
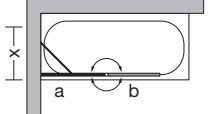

left	right	Height	Bathtub measurement (WM)	Width tub folding screen	Width of folding pieces	
<b>Single folding screen attached on fixed part</b> 		1500	All sizes	883 - 903	a = 238 b = 660 x = 710	
<b>CUSTOM MEASUREMENTS</b> - Measurement sketch needed. Height 1400 - 1700 mm. Overall width 900 - 1200 mm, moving element max. 650 mm. <b>Surcharge for triangular and rectangular cut-outs.</b>						
<b>Single folding screen attached on fixed part extra wide</b> 		1500	All sizes	1183 - 1203	a = 638 b = 560 x = 610  Incl. stabiliser.	
<b>CUSTOM MEASUREMENTS</b> - Measurement sketch needed. Height 1400 - 1700 mm. Overall width 1200 - 1400 mm, moving element max. 650 mm. <b>Surcharge for triangular and rectangular cut-outs.</b>						



**IMPORTANT**

- Folding screen attached on fixed part: Required installation height is total height + 30 mm.



Art. no.		Frame colour		Glazing		Glass finishing (optional)	
PR							
Base price				Surcharge			
left	right	<b>MA</b> High-gloss metal Matt aluminium	<b>WP</b> Matt white Graphite	<b>EK</b> Glass clear	<b>RW</b> Strip Satin	<b>C</b> ARTCLEAR GLAZING	
		<b>MP</b> High-gloss metal Graphite	<b>SP</b> Matt black Graphite			<b>ANNIVERSARY EDITION:</b> ARTCLEAR GLAS including ARTSHOWER Softedge hand shower PLUS.	
PRK1 52	PRK2 52	1,272	1,497	<b>EK</b>	0	211	+
				<b>RW</b>	259		
PRK1 88	PRK2 88	1,359	1,584				
		275	275				
PRK3 B2	PRK4 B2	1,420	1,645	<b>EK</b>	0	211	+
				<b>RW</b>	259		
PRK3 88	PRK4 88	1,515	1,740				
		275	275				



# Artweger MOVE

6 mm ESG

ARTWEGER price list 03/2023. For specialised trade outlets only. Suggested retail prices in EUR not including VAT.  
DIMENSIONS IN MILLIMETRES.

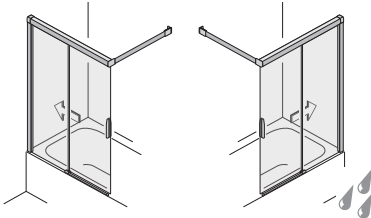
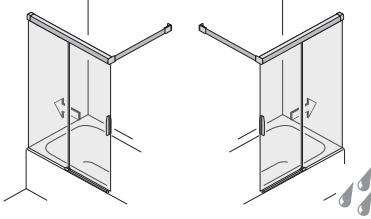
Fixed part left	Fixed part right	Height	Nominal width	Width	Fixed part width	Entrance width
<b>Double sliding door with frame</b> free-standing on bathtub 		1500	1200 1400	1170 - 1190 1370 - 1390	557 - 577 657 - 677	- -
<b>CUSTOM MEASUREMENTS</b> - Measurement sketch needed. Height 1300 - 1800 mm. Shower tray installation measurement 1000 - 1600 mm.						
<b>Double sliding door frameless</b> free-standing on bathtub 		1500	1000 - 1200 1201 - 1400	According to dimension sketch.		
<b>CUSTOM MEASUREMENTS</b> - Measurement sketch needed. Height 1300 - 1800 mm. Shower tray installation measurement 1000 - 1600 mm.						

1 door part and 1 fixed part

**Double sliding door frameless**  
free-standing on bathtub

1 door part and 1 fixed part

## IMPORTANT

- Required installation height is total height + 100 mm.

Art. no.		Frame colour			Glazing		Glass finishing (optional)	Comfort system
M								
Base price					Surcharge			
left	right	MH High-gloss metal	WS White SM Matt black LB Silver	WM Matt white GF Graphite metallic CN Champagne MK Mokka BZ Bronze . . . Additional colours	EK Glass clear RW Strip Satin SA Satin	C ARTCLEAR GLAZING	S SOFT OPEN SOFT CLOSE	
MGK1 B2	MGK2 B2	1,356	1,581	1,816	EK 0	211	116	
MGK1 E2	MGK2 E2	1,402	1,627	1,862	RW 204 SA 351			
MGK1 88	MGK2 88	1,542	1,767	2,002				
MRK1 B2	MRK2 B2	1,626	1,851	2,086	EK 0	211	116	
MRK1 E2	MRK2 E2	1,681	1,906	2,141	RW 204 SA 351			
MRK1 88	MRK2 88	1,849	2,074	2,309				

**IMPORTANT**

- When ordering please indicate assembly on shower tray or flush with floor.

# BASELINE

Folding screen glass thickness 3 mm

ARTWEGER price list 03/2023. For specialised trade outlets only. Suggested retail prices in EUR not including VAT.  
DIMENSIONS IN MILLIMETRES.

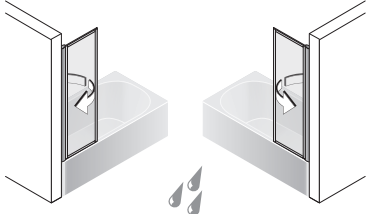
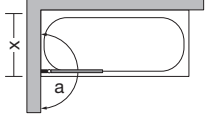
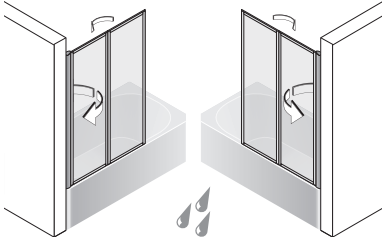
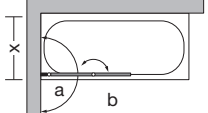
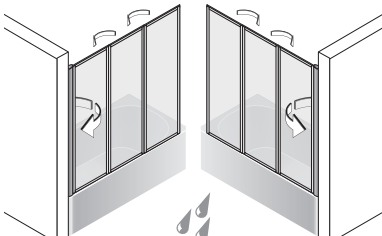
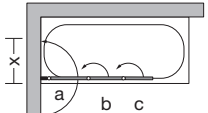
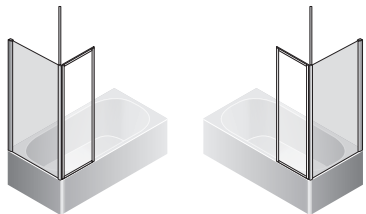
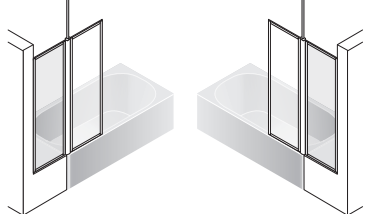
Can be installed on left or right.	Height	Bathtub measurement (WM)	Width tub folding screen	Width of folding pieces
<b>Single folding screen</b> 	<b>1500</b>	700 750	690 - 705 740 - 755	a = 690 - 705, x = 653 a = 740 - 755, x = 703 
<b>CUSTOM MEASUREMENTS</b> - Measurement sketch needed. Height 1100 - 1600 mm. Width 300 - 900 mm. <b>Surcharge for triangular and rectangular cut-outs.</b>				
<b>Double folding screen</b> 	<b>1500</b>	All sizes	1240 - 1255	a = 675 - 690 b = 565 x = 655 
<b>CUSTOM MEASUREMENTS</b> - Measurement sketch needed. Height 1100 - 1600 mm. Width 1100 - 1400 mm. <b>Surcharge for triangular and rectangular cut-outs. Triangular cut-out possible only on last part.</b>				
<b>Triple folding screen</b> 	<b>1500</b>	All sizes	1390 - 1405	a = 540 - 555 b = 440 c = 410 x = 520 
<b>CUSTOM MEASUREMENTS</b> - Measurement sketch needed. Height 1100 - 1600 mm. Width 1100 - 1600 mm. <b>Surcharge for triangular and rectangular cut-outs. Triangular cut-out possible only on last part.</b>				
<b>Side screen incl. ceiling support</b> 	<b>1500</b>	700 750 800	678 - 708 728 - 758 778 - 808	- - -  Can be combined with single, double and triple folding screen. Ceiling support extendable up to 1000 mm. Assembly without folding screen on request.
<b>CUSTOM MEASUREMENTS</b> - Measurement sketch needed. Height 1000 - 1600 mm. Width 300 - 1000 mm.				
<b>Side screen incl. ceiling support</b> 	<b>1000</b> - <b>1600</b>	Custom measurements	300 - 700	-  Can be combined with single, double and triple folding screen. Ceiling support extendable up to 1000 mm. The attached side screen can be swung in or out a maximum of 90°. Always custom manufacture. Measurement sketch needed. Assembly without folding screen on request.

## IMPORTANT

Art. no.		Colour		Glazing		Glass finishing for glass clear	
G							
Base price				Surcharge			
WM	Art. no.	NX Natural anodised	WS White LB Silver . . Additional colours	DD Synthetic glazing DIAMOND EK Glass clear	C ARTCLEAR GLAZING		
700	<b>GK 12</b>	665	798	<b>DD</b> 0	211		
750	<b>GK 32</b>	716	859	<b>EK</b> 65			
	<b>GK 18</b>	818	982				
		186	186				
	<b>GK 42</b>	858	1,030	<b>DD</b> 0 <b>EK</b> 213	211		
	<b>GK 48</b>	1,007	1,208				
		186	186				
	<b>GK 72</b>	932	1,118	<b>DD</b> 0 <b>EK</b> 227			
	<b>GK 78</b>	1,149	1,379				
		186	186				
700	<b>G6 12</b>	483	580	<b>DD</b> 0	211		
750	<b>G6 32</b>	508	610	<b>EK</b> 65			
800	<b>G6 42</b>	510	612				
	<b>G6 88</b>	544	653				
	<b>G6 Z8</b>	544	653	<b>DD</b> 0 <b>EK</b> 65			

# BODY+SOUL

## ELEMENTS OF BALANCE

- Individual custom-made steam showers
- Partially framed or frameless design
- Winged doors with fixed parts
- Barrier-free with Vario sealing system
- Certified adhesion technique
- Raise and lower mechanism

- Wall profile with 3D adjustment and concealed silicone joint
- 6 mm single-pane safety glass
- Standard height 2046 mm
- Custom sizes available
- Including ARTCLEAR GLASS without surcharge

### HANDLE TYPES

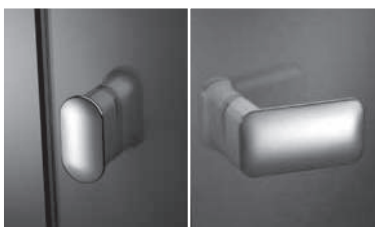

Knob **K**

Horizontal **R**

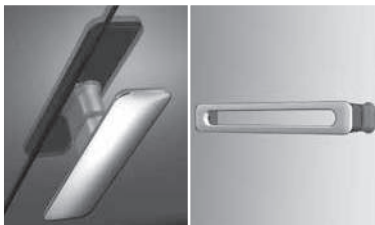

Vertical **H**

Bow-type **G**



### Folding seat

Individual seat or bench, folding.



### Steam box

with aroma drawer.



Artweger®

artclear  
GLASS

INCLUDED

CE

according to EN 14428



Especially EASY TO CLEAN.



Integrated coloured-light system (optional).



Integrated audio system (optional).

# BODY+SOUL FEATURES

ARTWEGER price list 03/2023. For specialised trade outlets only.

## Attachment to the wall

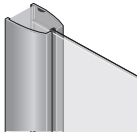

**PARTIALLY FRAMED**  
With wall profile.  
Adjustment of up to 20 mm  
(±10 mm) to allow for uneven  
or sloped walls.

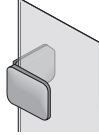

**FRAMELESS**  
Brackets inwards.  
Attachment to wall is on the  
interior of the shower.

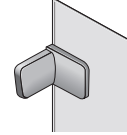

**FRAMELESS optional**  
Brackets outwards.  
Wall bracket on the outside of  
the shower. Please indicate when  
ordering.

BODY+SOUL  
Steam showers

## LEFT/RIGHT in the case of an asymmetric shower tray

**LEFT**  
**7R81 HH**  
**7P81 HH**  
Door on wide  
fixed part

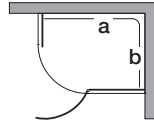
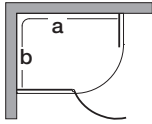

**RIGHT**  
**7R82 HH**  
**7P82 HH**  
Door on wide  
fixed part

**LEFT**  
**7R81 UH**  
**7P81 UH**  
Door on narrow  
fixed part

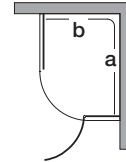
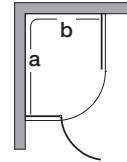

**RIGHT**  
**7R82UH**  
**7P82UH**  
Door on narrow  
fixed part

### IMPORTANT

- We will gladly send you the documents in hard copy on request.

# BODY+SOUL OVERVIEW OF PRODUCT FEATURES

ARTWEGER price list 03/2023. For specialised trade outlets only.

## SHOWER TRAYS

- BODY+SOUL can optionally be installed on a shower tray or flush with the floor.
- **Matching acrylic shower trays see page 226, ARTSTONE mineral cast shower trays see page 224.**

## SHOWER ENCLOSURE WITH ROOF ELEMENT

- Shower enclosure made of 6 mm single-pane safety glass including ARTCLEAR GLASS.
- Winged door opening outwards with lifting/sinking hinges and sealing and magnetic strips.
- Your choice of hinge on left or right.
- Artweger adhesive technology for smooth glass inner surfaces and especially easy cleaning.
- Optionally with wall moulding to compensate for dimensional tolerances and/or sloping wall.
- Alternatively frameless for transparent look. Measurement sketch needed.
- Assembly on shower tray or flush with floor. Dimension sketch required when installing flush with floor.
- Standard height 2046 mm. Total height of steam shower depends on the chosen installation variation. Required installation height is total height + 150 mm.
- Overflow moulding to enhance watertightness in the entrance area is included. Installation optional.
- Individual dimensions available. Custom designs always on request.

## ROOF ELEMENT

- Plastic plate with aluminium frame, white. Required to ensure steam does not escape.
- Optional audio unit with speaker, USB port for MP3 and 3.5 mm stereo jack. Can be extended using a standard USB cable up to 5 m long. Optional LED coloured light unit with 7 directly selectable colours. In addition free choice of colour and adjustable colour intensity. Audio unit includes Bluetooth adapter for wireless enjoyment of music from Smartphone/Tablet/PC/Mac. The audio and coloured light units are operated by remote control.
- Flow rate of overhead showerhead at 3 bar pressure ca. 11 l/min.

## STEAM BOX

- Steam generator including aroma drawer and adjustable steam exit nozzle.
- Aroma drawer optionally for herbs or oils. Space required to pull out aroma drawer 200 mm.
- Adjustable heat.
- Decalcification function taking into account the local water hardness, automatic rinsing procedure.
- Boiler empties automatically with protection against scalding.
- Control of the steam functions. Steam duration, temperature, decalcification.
- Remote control for operating the audio and light functions. Audio source, volume, coloured light selection, light intensity. Charging station for remote control mounted on steam box.
- Easy-to-clean surfaces, available in various colours.
- Total filling volume 880 ml. Vaporized amount of water about 4.5 l per hour.
- Space volume 2.6 m<sup>3</sup> maximum per steam generator.

## BODY+SOUL DESIGN RECOMMENDATION

### Winged door with side screen 900 x 900 mm



Hinge on left

Please order fittings and showering equipment separately.

When used on tiled floors a furrow or slant in the floor (toward the drain within the shower area) is necessary.

### Components

### Prices in EUR

#### On tiled floor

#### Shower enclosure with roof element

#### PARTIALLY FRAMED

Winged door width:	900 mm	
Side screen width:	900 mm	
Height of shower enclosure:	2046 mm	
Frame colour:	High-gloss metal	
Glazing:	glass clear incl. ARTCLEAR GLASS	
Handle type:	horizontal	
Handle and hinge:	Chrome	
Roof element:	without accessories	
Art. no. left:	7P91 5H MHEKR 1	3,425

#### Steam box

Aroma drawer:	left	
Colour:	Anthracite/silver	
Art. no.:	7D11 11 AT	4,341

#### Seat

Seat with backrest		
Colour:	Anthracite/silver	
Art. no.:	7SE0 11 AT	1,120

**Total price in EUR:**

**8,886**



# BODY+SOUL OVERVIEW OF PRODUCT FEATURES

ARTWEGER price list 03/2023. For specialised trade outlets only.

## SEAT

- **Folding seats are mounted on the tiled side walls. A load-bearing wall must be available to mount the seat.**
- With integrated motion damper for smooth folding.
- At a width of 1100 mm or more, the bench with 2 seating surfaces and continuous backrest can be used.
- Easy-to-clean surfaces, available in various colours.

## GENERAL NOTES

- **Notice to persons with pacemakers: In the seat back and in the front cover of the steam generator are magnets.**
- Please note our pre-installation information.
- When installing and operating for the first time, please observe DIN 1986, DIN 1988 and EN 1717 as well as current country-specific standards.
- The electrical installation may only be carried out by a licensed specialist under consideration of regulation VDE 0100-701.
- Ensure sufficient heat insulation including moisture barrier in the wall before installing the BODY+SOUL. Otherwise the attainment of a comfortable operating temperature cannot be guaranteed.
- Plan for electrical conduits for external audio wires if needed.
- BODY+SOUL has a variety of adjustment possibilities for individually desired application variations and is conceived exclusively for use in private bathrooms.

## ELECTRICAL CONNECTION 230V / 500 / 60Hz

- Connected load max. 3,4 kW
- Separate power supply 3 × 1,5 mm<sup>2</sup> (H05-VV-F)
- Fuse 16 A
- Standby 0,8 W
- Standby with remote control 1,6 W
- Wiring over FI circuit breaker. RCD IΔn ≤ 30 mA. Conduit from above, diameter at least 20 mm, laid at least 50 mm deep. The wiring must be installed over a bipolar switch which is at least outside protected zone 2. Observe current regulations for potential equalisation.

## WATER CONNECTION

- Water connection for steam box: DN 15 1/2" set corner control valve, outlet 3/8"
- Water connection for overhead showerhead: DN 15 1/2"
- Water connection for fittings: According to the fittings selected.  
(Please order fittings and showering equipment separately.)
- Minimum flow pressure: 1,5 bar

## BODY+SOUL DESIGN RECOMMENDATION

### Winged door with side screen 1200 × 1000 mm



Hinge on left  
Please order fittings and showering equipment separately.

**Total height depends on installation height of the shower tray.**

Components	Prices in EUR
<b>Shower tray</b>	
Artweger SIMONE 1200 × 1000 × 45 mm, white With set of shower-tray feet, mounting brackets and drain set.	
Art. no.: WV 19 WS	816
Art. no.: WH 06	95
Art. no.: WH 04	44
Art. no.: W0 01 VC	100
<b>Shower enclosure with roof element</b>	
PARTIALLY FRAMED	
Winged door width:	1200 mm
Side screen width:	1000 mm
Height of shower enclosure:	2046 mm
Frame colour:	High-gloss metal
Glazing:	glass clear incl. ARTCLEAR GLASS
Handle type:	horizontal
Handle and hinge:	Chrome
Roof element:	with audio, coloured light and overhead showerhead
Art. no. left:	7P91 GHMHEK R 3K 7,739
<b>Steam box</b>	
With controls for audio and coloured light	
Aroma drawer:	left
Colour:	Anthracite/silver
Art. no.:	7D31 11 AT 5,643
<b>Seat</b>	
Bench with continuous backrest	
Colour:	Anthracite/silver
Art. no.:	7SB0 21 AT 2,400
<b>Total price in EUR:</b>	<b>16,837</b>

# BODY+SOUL PARTIALLY FRAMED

Winged door 6 mm ESG

ARTWEGER price list 03/2023. For specialised trade outlets only. Suggested retail prices in EUR not including VAT.  
DIMENSIONS IN MILLIMETRES.

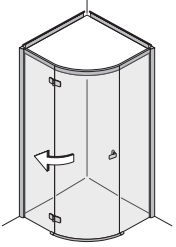
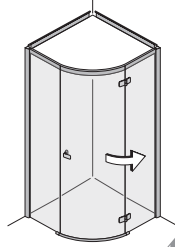
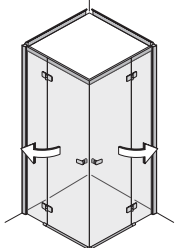
Hinge left	Hinge right	Height	Shower tray measurement (WM) length a x width b	Shower tray installation measurement	Fixed part width	Entrance width
<b>1/4-round shower with roof</b>						
						
1 winged door and 2 fixed parts		2046	900 × 900 II R=550	880 - 900	375 - 395	650
			1000 × 1000 II R=550	980 - 1000	475 - 495	650
			1200 × 1200 II R=550	1180 - 1200	675 - 695	650
			1200 × 900 II R=550	1180 - 1200 × 880 - 900	675 - 695 × 375 - 395	650
			1200 × 900 II R=550	1180 - 1200 × 880 - 900	675 - 695 × 375 - 395	650
<p><b>CUSTOM MEASUREMENTS</b> - Measurement sketch needed.                      Maximum width: 1200 × 1200 mm. Height 2046 mm - custom heights not available.                      fixed-part custom width (narrower or wider) per side.                      Radius of glazing = 518 mm. The manufacture of individually curved glass is not possible. Dimension tolerances to the tiled shower area are possible for technical reasons.</p> <p><b>Surcharge for triangular and rectangular cut-outs.</b></p>						
<b>Corner entry with roof</b>						
						
2 winged doors and 2 fixed parts		2046	900 × 900	880 - 900	240 - 260	840
			1000 × 1000	980 - 1000	340 - 360	840
			left 1000 × 800 right	980 - 1000 × 780 - 800	340 - 360 × 240 - 260	770
			800 × 1000	780 - 800 × 980 - 1000	240 - 260 × 340 - 360	770
			1000 × 900	980 - 1000 × 880 - 900	340 - 360 × 240 - 260	840
			900 × 1000	880 - 900 × 980 - 1000	240 - 260 × 340 - 360	840
<p><b>CUSTOM MEASUREMENTS</b> - Measurement sketch needed.                      Floor area at most 1.3 m<sup>2</sup> at 2046 mm height.                      Maximum widths: 1400 × 900 mm or 1300 × 1000 mm.                      Heights up to 2200 mm on request.                      Price for combination of custom and standard measurement:                      (custom price + standard price) / 2.</p> <p><b>Surcharge for triangular and rectangular cut-outs.</b></p>						

**IMPORTANT**

• Required installation height is total height + 150 mm.

Art.no.		Colour	Glazing	Handle type	Roof element	Overhead showerhead
7	P					

Base price

Surcharge

left	right	MH High-gloss metal . . Additional colours	EK Glass clear RW Strip Satin incl. ARTCLEAR GLASS	K Knob R Horizontal H Vertical G Bow-type	1 without features 3 Audio and coloured light	K with overhead showerhead (optional)
7P81 2H	7P82 2H	4,029				
7P81 6H	7P82 6H	4,413				
7P81 0H	7P82 0H	4,881	EK 0 RW -	K 0 R 0 H 0 G -	1 0 3 3,442	648
7P81 HH	7P82 HH	4,594				
7P81 UH	7P82 UH					
7P81 88	7P82 88	5,076				
		322				
7PE0 5H		3,553				
7PE0 6H						
7PE0 AH			EK 0 RW 518	K 0 R 0 H 0 G 331	1 0 3 3,442	648
7PE0 BH		3,919				
7PE0 CH						
7PE0 DH						
7PE0 88		4,224				
		322				

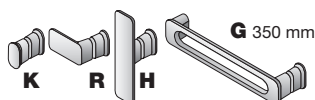

BODY+SOUL  
Steam showers

# BODY+SOUL PARTIALLY FRAMED

Winged door 6 mm ESG

ARTWEGER price list 03/2023. For specialised trade outlets only. Suggested retail prices in EUR not including VAT.  
DIMENSIONS IN MILLIMETRES.

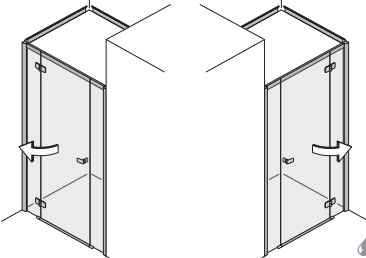
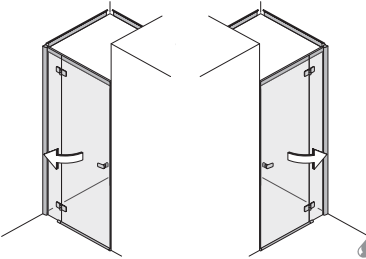
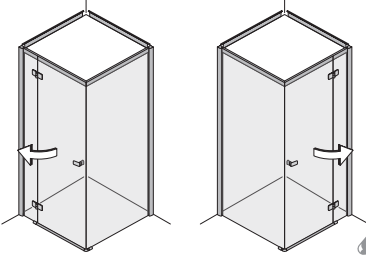
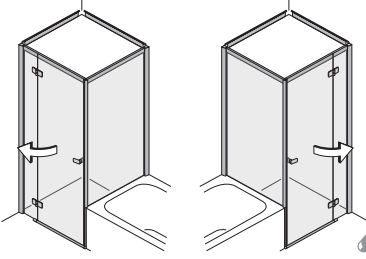
Hinge left	Hinge right	Height	Shower tray measurement (WM)	Shower tray installation measurement	Fixed part width	Entrance width	
 <p>Winged door in alcove with roof</p> <p>1 door part and 2 fixed parts</p>		2046	900 × 900	880 - 900		150 - 170	530
			1000 × 1000	980 - 1000		150 - 170	630
			1000 × 800	980 - 1000 × 780 - 800	Door at 1000	150 - 170	630
			1000 × 900	980 - 1000 × 880 - 900	Door at 1000	150 - 170	630
			1200 × 800	1180 - 1200 × 780 - 800	Door at 1200	250 - 270	630
			1200 × 900	1180 - 1200 × 880 - 900	Door at 1200	250 - 270	630
			1200 × 1000	1180 - 1200 × 980 - 1000	Door at 1200	250 - 270	630
			1400 × 900	1380 - 1400 × 880 - 900	Door at 1400	350 - 370	630
<p><b>CUSTOM MEASUREMENTS</b> - Measurement sketch needed. Floor area at most 1.3 m<sup>2</sup> at 2046 mm height. Maximum widths: Door 1400 mm/depth of alcove 900 mm or door 1300 mm/depth of alcove 1000 mm Heights up to 2200 mm on request.</p> <p><b>Surcharge for triangular and rectangular cut-outs.</b></p>							
 <p>Winged door in alcove with roof</p> <p>1 door part and 1 fixed part</p>		2046	900 × 900	880 - 900		150 - 170	680
			1000 × 1000	980 - 1000		250 - 270	680
			1000 × 800	980 - 1000 × 780 - 800	Door at 1000	250 - 270	680
			1000 × 900	980 - 1000 × 880 - 900	Door at 1000	250 - 270	680
<p><b>CUSTOM MEASUREMENTS</b> - Measurement sketch needed. Floor area at most 1.3 m<sup>2</sup> at 2046 mm height. Door 1200 mm/depth of alcove 1000 mm Heights up to 2200 mm on request.</p> <p><b>Surcharge for triangular and rectangular cut-outs.</b></p>							
 <p>Winged door with side screen and roof</p> <p>1 door part, 1 fixed part, 1 side screen</p>		2046	900 × 900	880 - 900		150 - 170	680
			1000 × 1000	980 - 1000		250 - 270	680
			1000 × 800	980 - 1000 × 780 - 800	Door at 1000	250 - 270	580
			1000 × 900	980 - 1000 × 880 - 900	Door at 1000	250 - 270	680
			1200 × 800	1180 - 1200 × 780 - 800	Door at 1200	450 - 470	580
			1200 × 900	1180 - 1200 × 880 - 900	Door at 1200	450 - 470	680
			1200 × 1000	1180 - 1200 × 980 - 1000	Door at 1200	450 - 470	680
<p>Hinge always on the wall side.</p> <p><b>CUSTOM MEASUREMENTS</b> - Measurement sketch needed. Floor area at most 1.3 m<sup>2</sup> at 2046 mm height. Maximum widths: Door 1400 mm/side screen 900 mm or door 1300 mm/side screen 1000 mm. Heights up to 2200 mm on request.</p> <p><b>Surcharge for triangular and rectangular cut-outs.</b></p>							
 <p>Winged door with shorter side screen and roof</p> <p>1 door part, 1 fixed part, 1 side screen</p>		2046	<b>CUSTOM MEASUREMENTS</b> - Measurement sketch needed.				
			Floor area at most 1.3 m <sup>2</sup> at 2046 mm height.				
			Maximum widths: Door 1400 mm/side screen 900 mm or door 1300 mm/side screen 1000 mm.				
<p>Heights up to 2200 mm on request. Hinge always on the wall side.</p> <p><b>Surcharge for triangular and rectangular cut-outs.</b></p>							

**IMPORTANT**

Art.no.		Colour	Glazing	Handle type/ Towel holder	Roof element	Overhead showerhead
7 P						
Base price			Surcharge			
left	right	MH High-gloss metal . . Additional colours	EK Glass clear RW Strip Satin  incl. ARTCLEAR GLASS	K Knob R Horizontal H Vertical G Bow-type T Towel holder	1 without features 3 Audio and coloured light	K with overhead showerhead (optional)
7P41 5H	7P42 5H	2,734				
7P41 6H	7P42 6H					
7P41 AH	7P42 AH	2,818				
7P41 CH	7P42 CH		EK 0 RW 259	K 0 R 0 H 0 G 166 T -	1 0 3 3,442	648
7P41 EH	7P42 EH					
7P41 FH	7P42 FH	3,004				
7P41 GH	7P42 GH					
7P41 HH	7P42 HH	3,118				
7P41 88	7P42 88	3,190				
		322				
7P51 5H	7P52 5H	2,621				
7P51 6H	7P52 6H					
7P51 AH	7P52 AH	2,664	EK 0 RW 259	K 0 R 0 H 0 G 166 T -	1 0 3 3,442	648
7P51 CH	7P52 CH					
7P51 88	7P52 88	2,923				
		322				
7P91 5H	7P92 5H	3,425				
7P91 6H	7P92 6H					
7P91 AH	7P92 AH	3,542	EK 0 RW 461	K 0 R 0 H 0 G 166 T 252	1 0 3 3,442	648
7P91 CH	7P92 CH					
7P91 EH	7P92 EH					
7P91 FH	7P92 FH	3,649				
7P91 GH	7P92 GH					
7P91 88	7P92 88	3,729				
		322				
7P71 88	7P72 88	3,729	EK 0 RW 461	K 0 R 0 H 0 G 166 T 252	1 0 3 3,442	648
		322				

BODY+SOUL  
Steam showers

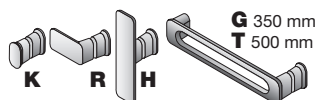

IMPORTANT

# BODY+SOUL FRAMELESS

Winged door 6 mm ESG

ARTWEGER price list 03/2023. For specialised trade outlets only. Suggested retail prices in EUR not including VAT.  
DIMENSIONS IN MILLIMETRES.

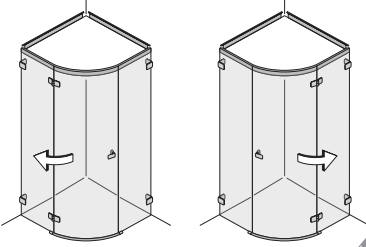
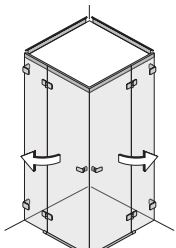
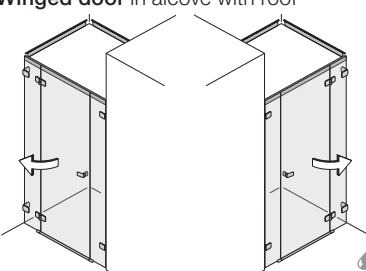
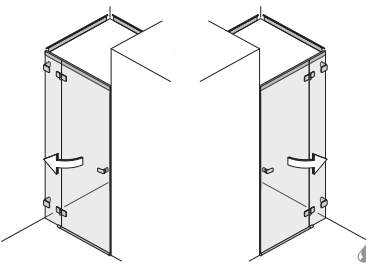
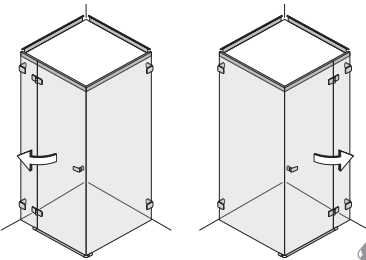
Hinge left	Hinge right	Height	Shower tray measurement length a x width b	Shower tray installation measurement	Entrance width
<b>1/4-round shower with roof</b> 		<b>2046</b>	900 × 900 II R=550 1000 × 1000 II R=550 1200 × 1200 II R=550 1200 × 900 II R=550 Door on wide fixed part 1200 × 900 II R=550 Door on narrow fixed part	<ul style="list-style-type: none"> <li>According to dimension sketch.</li> </ul>	650 650 650 650 650
1 winged door and 2 fixed parts			<b>CUSTOM MEASUREMENTS</b> - Measurement sketch needed. fixed-part extra width per side. Custom heights not available. <b>Surcharge for triangular and rectangular cut-outs.</b>		
<b>Corner entry with roof</b> 		<b>2046</b>	up to 1000 × 1000	<ul style="list-style-type: none"> <li>According to dimension sketch.</li> <li>Door 640 mm max.</li> <li>fixed-part at least 170 mm wide.</li> </ul>	up to 840
2 winged doors and 2 fixed parts			<b>CUSTOM MEASUREMENTS</b> - Measurement sketch needed. Floor area at most 1.3 m <sup>2</sup> at 2046 mm height. Maximum widths: 1400 × 900 mm or 1300 × 1000 mm. Heights up to 2200 mm on request. Price for combination of custom and standard measurement: (custom price + standard price) / 2. <b>Surcharge for triangular and rectangular cut-outs.</b>		
<b>Winged door in alcove with roof</b> 		<b>2046</b>	up to 1000 up to 1400	<ul style="list-style-type: none"> <li>According to dimension sketch.</li> <li>Door max. 750 mm wide.</li> <li>fixed-part at least 170 mm wide.</li> <li>Width of alcove 1400 mm max.</li> <li>Depth of alcove 1000 mm max.</li> </ul>	up to 630
1 door part and 2 fixed parts			<b>CUSTOM MEASUREMENTS</b> - Measurement sketch needed. Floor area at most 1.3 m <sup>2</sup> at 2046 mm height. Maximum widths: Door 1400 mm/depth of alcove 900 mm or door 1300 mm/depth of alcove 1000 mm. Door max. 750 mm wide. Heights up to 2200 mm on request. <b>Surcharge for triangular and rectangular cut-outs.</b>		
<b>Winged door in alcove with roof</b> 		<b>2046</b>	up to 1000	<ul style="list-style-type: none"> <li>According to dimension sketch.</li> <li>Door max. 750 mm wide.</li> <li>fixed-part at least 170 mm wide.</li> <li>Width of alcove 1200 mm max.</li> <li>Depth of alcove 1000 mm max.</li> </ul>	up to 680
1 door part and 1 fixed part			<b>CUSTOM MEASUREMENTS</b> - Measurement sketch needed. Floor area at most 1.3 m <sup>2</sup> at 2046 mm height. Maximum widths: Door 1200 mm/depth of alcove 1000 mm. Door max. 750 mm wide. Heights up to 2200 mm on request. <b>Surcharge for triangular and rectangular cut-outs.</b>		
<b>Winged door with side screen and roof</b> 		<b>2046</b>	up to 1000 × 1000 up to 1200 × 1000	<ul style="list-style-type: none"> <li>According to dimension sketch.</li> <li>Door max. 750 mm wide.</li> <li>fixed-part at least 170 mm wide.</li> <li>Door at 1200 mm, side screen at 1000 mm.</li> <li>Hinge always on the wall side.</li> </ul>	up to 680
1 door part, 1 fixed part, 1 side screen			<b>CUSTOM MEASUREMENTS</b> - Measurement sketch needed. Floor area at most 1.3 m <sup>2</sup> at 2046 mm height. Maximum widths: Door 1400 mm/side screen 900 mm or door 1300 mm/side screen 1000 mm. Door max. 750 mm wide. Heights up to 2200 mm on request. <b>Surcharge for triangular and rectangular cut-outs.</b>		

## IMPORTANT

Art.no.	Colour	Glazing	Handle type/ Towel holder	Roof element	Overhead showerhead
7 R					

Base price

Surcharge

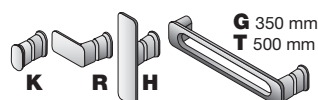

left	right	VC Chrome WS White	EK Glass clear RW Strip Satin incl. ARTCLEAR GLASS	K Knob R Horizontal H Vertical G Bow-type T Towel holder	1 without features 3 Audio and coloured light	K with overhead showerhead (optional)
7R81 2H	7R82 2H	4,062				
7R81 6H	7R82 6H	4,447				
7R81 0H	7R82 0H	4,904	EK 0 RW -	K 0 R 0 H 0 G -	1 0 3 3,442	648
7R81 HH	7R82 HH	4,621				
7R81 UH	7R82 UH					
7R81 88	7R82 88	5,251 275				
7RE0 6H		4,010	EK 0 RW 518	K 0 R 0 H 0 G 331	1 0 3 3,442	648
7RE0 88		4,580 275				
7R41 6H	7R42 6H	2,993	EK 0 RW 259	K 0 R 0 H 0 G 166 T -	1 0 3 3,442	648
7R41 HH	7R42 HH	3,274				
7R41 88	7R42 88	3,571 275				
7R51 6H	7R52 6H	2,931	EK 0 RW 259	K 0 R 0 H 0 G 166 T -	1 0 3 3,442	648
7R51 88	7R52 88	3,119 275				
7R91 6H	7R92 6H	3,662	EK 0 RW 461	K 0 R 0 H 0 G 166 T 252	1 0 3 3,442	648
7R91 BH	7R92 BH	3,783				
7R91 88	7R92 88	4,126 275				

BODY+SOUL  
Steam showers

IMPORTANT

# BODY+SOUL STEAM BOX, SEAT, BENCH

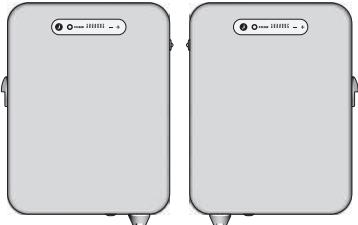
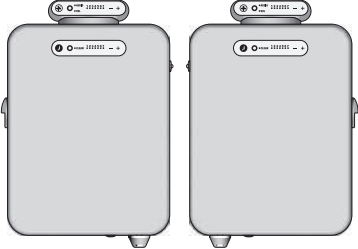
ARTWEGER price list 03/2023. For specialised trade outlets only. Suggested retail prices in EUR not including VAT.  
DIMENSIONS IN MILLIMETRES.

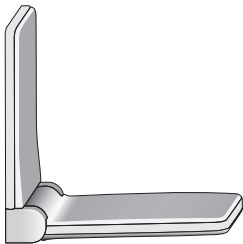
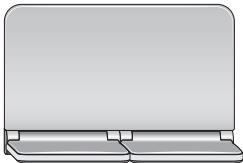
left	right	Height	Width	Depth	Product description
<b>Steam box</b> 		500	385	100	<ul style="list-style-type: none"> <li>• Steam generator, 3.4 kW, 230 V, 50/60Hz incl. aroma drawer for herbs and oils.</li> <li>• Temperature adjustable in 7 levels. Comfortable steam enjoyment by means of adjustable heat level.</li> <li>• Empties automatically after each use.</li> <li>• Decalcification programme</li> <li>• High quality surfaces in attractive colours.</li> <li>• Also suitable for installation in existing showers. (Connection to electricity and cold water must be available, walls must be sufficiently insulated, and shower enclosure must not allow steam to escape.)</li> <li>• <b>Space volume 2.6 m<sup>3</sup> maximum per steam generator. Not suitable for the use in Switzerland. For this purpose, use Art. No. 7D13 11/ 7D14 11.</b></li> </ul>
<b>Steam box</b> with audio and coloured light controls 		500	385	100	<ul style="list-style-type: none"> <li>• Steam generator, 3.4 kW, 230 V, 50/60Hz incl. aroma drawer for herbs and oils.</li> <li>• Incl. remote control for audio and coloured light (roof element with audio and coloured light required).</li> <li>• Temperature adjustable in 7 levels. Comfortable steam enjoyment by means of adjustable heat level.</li> <li>• Empties automatically after each use.</li> <li>• Decalcification programme</li> <li>• High quality surfaces in attractive colours.</li> <li>• <b>Space volume 2.6 m<sup>3</sup> maximum per steam generator. Not suitable for the use in Switzerland. For this purpose, use Art. No. 7D33 11/ 7D34 11.</b></li> </ul> <div style="display: flex; justify-content: space-around; align-items: center;"> <div style="text-align: center;">  Front: Audio         </div> <div style="text-align: center;">  Back: Coloured light         </div> </div>
<b>Seat</b> 		500	385	70/90	<ul style="list-style-type: none"> <li>• Folding seat with backrest, generously dimensioned.</li> <li>• High quality surfaces in attractive colours.</li> <li>• Folding mechanism with motion damper and magnetic catch.</li> <li>• A load-bearing wall must be available to mount the seat.</li> <li>• For special types of walls such as aerated concrete the fixation materials have to be suitable ones recommended by the construction company.</li> <li>• Capacity up to 130 kg.</li> <li>• Overhang: 510 mm</li> </ul>
<b>Bench</b> 		500	770	70/90	<ul style="list-style-type: none"> <li>• Can be used in spaces 1100 mm and wider.</li> <li>• 2 folding seats with a continuous backrest, generously dimensioned.</li> <li>• High quality surfaces in attractive colours.</li> <li>• Folding mechanism with motion damper and magnetic catch.</li> <li>• A load-bearing wall must be available to mount the seat.</li> <li>• For special types of walls such as aerated concrete the fixation materials have to be suitable ones recommended by the construction company.</li> <li>• Capacity up to 130 kg per folding seat.</li> <li>• Overhang: 510 mm</li> </ul>

## IMPORTANT



left	right	Plastic		Glass
		BD Bordeaux/silver	AT Anthracite/silver SA Sand/silver	GH Glass clear/silver GT Glass anthracite/silver GB Glass Bordeaux/silver
7D11 11	7D12 11	-	4,341	4,487
7D31 11	7D32 11	-	5,643	5,789
7SE0 11		1,120	1,120	-
7SB0 21		2,400	2,400	-

## IMPORTANT

- When installing wall heating please request drilling position sketch beforehand.
- Custom sizes not available.

# TWINLINE 1

Bath and shower. The Artweger TWINLINE makes it possible.

- Shower bathtub with extra large shower area
- Full-sized walk-in door opens inwards
- Mechanical closure
- Certified adhesion technique
- Wall profile with 3D adjustment and concealed silicone joint
- 6 mm single-pane safety glass
- Standard height 1900 or 2045 mm
- Entry height of 180 mm, which can be reduced to 70 mm
- Optionally as Airpool



The handle engages automatically when the door is closed.



The tub's special drain shortens the water's draining time.



Neck support and seat are soft and removable.



Artweger  
**TWIN:LINE**

artclear  
GLASS

CE

according to EN 14428  
and EN 14516

# ACCESSORIES

ARTWEGER price list 03/2023. For specialised trade outlets only.  
Suggested retail prices in EUR not including VAT. DIMENSIONS IN MILLIMETRES.

Art. no.	Colour
□ □ □ □ □ □ □ □	□ □
Base price	

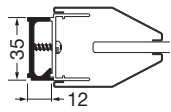

**Compound bracket 12 mm**  
Extends adjustment range of the shower door by 12 mm. Required when installing on already tiled wall.

Height	Art. no.	WS White LB Silver . . Additional colours	MH High-gloss metal
1500	<b>TL0P 32</b>	132	145
1355	<b>TL0P 31</b>	123	135



**Flexible connection hose, 3/4"**  
For inlet/drain/overflow set.

Length	Art. no.	. . Colour not specified
1500	<b>TL0H 33</b>	50

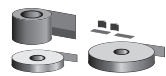

**Sealing tape**  
For sealing and sound installation between the tub, the structure and the tiles. Including the tile tape.

Length	Art. no.	
3600	<b>W012</b>	97

TWINLINE 1  
Shower bathtubs

## TWINLINE 1 DESIGN RECOMMENDATION

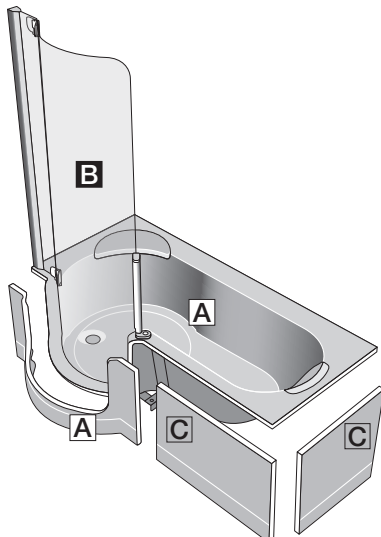

### Corner installation left

#### Bathtub 1800 x 1000 / 800 mm

- With mechanical closure.
- Plastic tub in white.
- Door skirt with fastener.
- Drain, overflow included.
- Seat and neck support in white.
- With pre-mounted assembly angles and tub feet.

#### Shower door

- Colour: high-gloss metal
- Glazing: glass clear incl. ARTCLEAR GLASS

#### Skirt 05 (optional)

- Plastic skirt in white.

	Art. no.	Prices in EUR
<b>A</b>	<b>TLM1 04 WS WS</b>	4,690
<b>B</b>	<b>TL81 87 MHEKVC</b>	2,270
<b>C</b>	<b>TL0E 03 WS</b>	1,150

**Total price in EUR: 8,110**

### IMPORTANT

- We will gladly send you the documents in hard copy on request.

# TWINLINE 1 DIMENSIONS

ARTWEGER price list 03/2023. For specialised trade outlets only. DIMENSIONS IN MILLIMETRES.

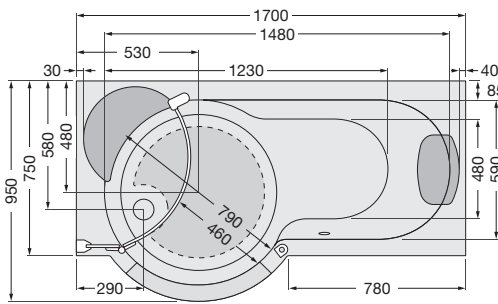
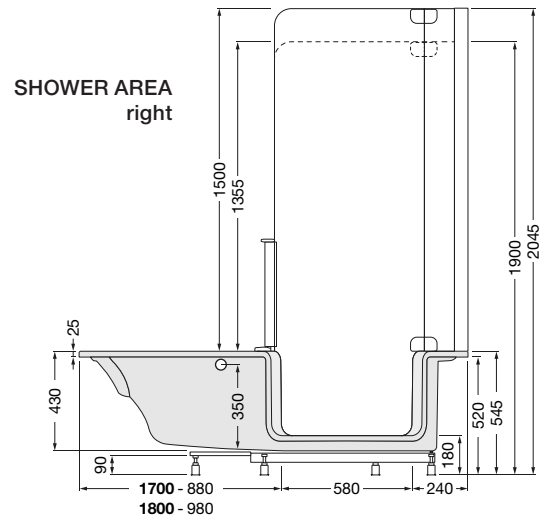
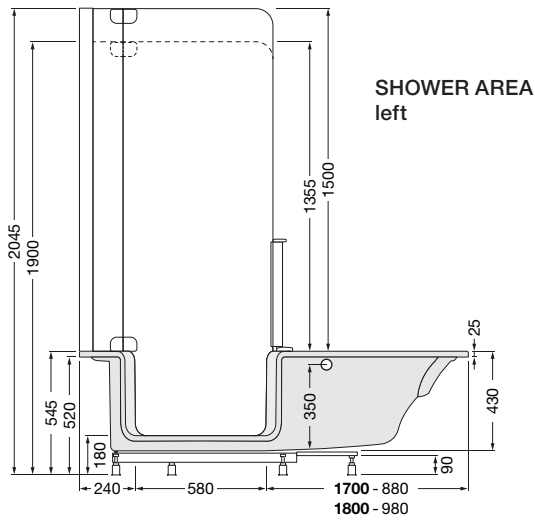

**TWINLINE 1**  
1700 x 950 / 750  
depth 430

Tub capacity  
ca. 180 litres.

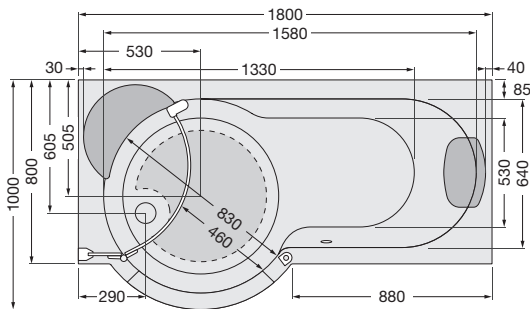
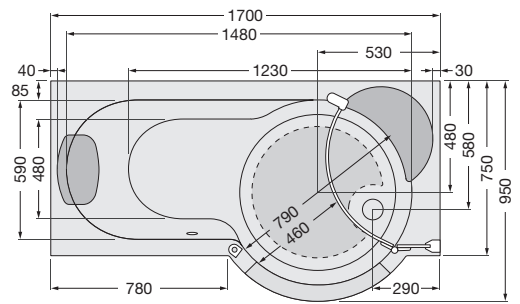

**TWINLINE 1**  
1800 x 1000 / 800  
depth 430

Tub capacity  
ca. 225 litres.

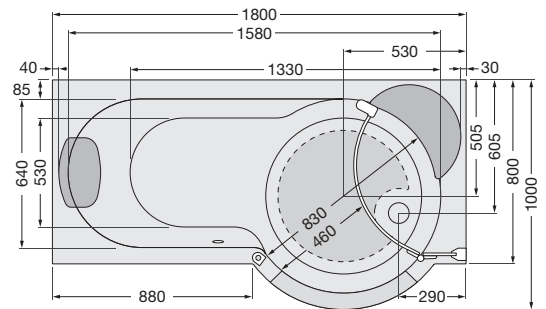

# TWINLINE 1 OVERVIEW OF PRODUCT FEATURES

ARTWEGER price list 03/2023. For specialised trade outlets only.

## Bathtub

- Plastic tub in white.
- Door skirt in white (GRP) with fastener. - GRP: Glassfibre Reinforced Plastic
- Drain, overflow chrome-plated (standard) - Inlet/drain/overflow chrome-plated (optional).
- Seat and neck support.
- Generous shower area.
- With pre-mounted assembly angles and tub feet. Including height-adjustable feet.
- Optional: ART-Grip - anti-slip zone anti-slip coating class C according to DIN 51097.
- Tub capacity: Approximate average water consumption of a full bath with one person.

## With mechanical closure for installation without electricity.

### Shower door

- Door opens to inside. Entrance width 460 mm. Handle with locking mechanism. Single-pane safety glass 6 mm.
- When installing the shower door on the already tiled wall a 12 mm compound bracket is required. See page 189.

### Shower door with side screen

- Door opens to inside. Entrance width 460 mm. Handle with locking mechanism. Single-pane safety glass 6 mm.
- Includes side screen with ceiling support and a special skirt for tiling. This skirt provides additional stability to the bathtub edge and is to be installed during installation of the bathtub. Otherwise proper functioning of the TWINLINE 1 cannot be ensured.
- Ceiling support extendable up to 700 mm. Solid ceiling required for fixing the ceiling support.
- When installing the shower door on the already tiled wall a 12 mm compound bracket is required. See page 189.

## Skirt

- To allow for maintenance and service we recommend installing the TWINLINE 1 skirting or tile backing board.
- The door skirt is generally supplied in white plastic. Door skirt not available with glass surface.

## TWINLINE 1 AIR - The other kind of Airpool.

- Control element built into tub's edge.
- Due to the air system used, no regular disinfection is necessary. Automatic blowing-out of the jets after every use of bath and shower.
- 24 x Air jets in bottom area. 2 x LED coloured light with 7 colours. Air membrane pump 45 W.
- 230V/50/60Hz electrical connection required.
- Power consumption max. 50 W. Standby 8 W.
- Deeper set installation on rough concrete not possible.

ART-Grip Skid-resistant zone (scheme)

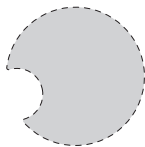

TWINLINE 1 AIR arrangement of equipment

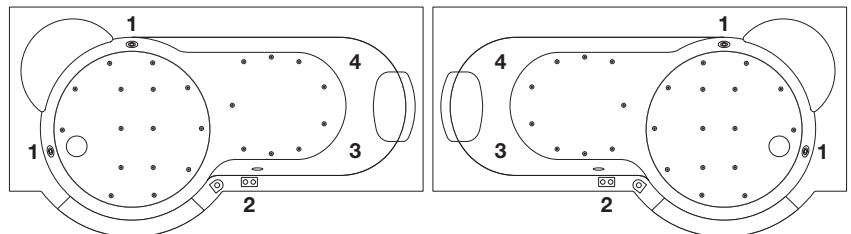

1 = LED coloured light, 2 = control element AIR,  
3 = electrical connection and electronic control, 4 = membrane pump

# TWINLINE 1

Winged door 6 mm ESG

ARTWEGER price list 03/2023. For specialised trade outlets only. Suggested retail prices in EUR not including VAT. DIMENSIONS IN MILLIMETRES.

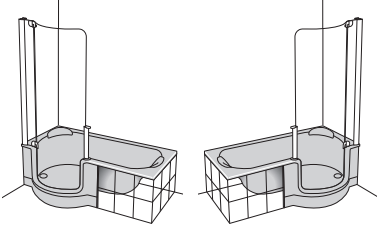
SHOWER AREA	Product description/ features	Length × width
left                      right		
<b>Bathtub</b>	<ul style="list-style-type: none"> <li>• With mechanical closure.</li> <li>• Please order shower door extra.</li> </ul>	1700 × 950 / 750 1800 × 1000 / 800
	<ul style="list-style-type: none"> <li>• <b>TWINLINE 1 AIR</b> with mechanical closure.</li> <li>• Please order shower door extra.</li> <li>• <b>Installation of an Artweger tub skirt is required for maintenance and service.</b></li> <li>• <b>Please order tub skirt separately. See page 194.</b></li> <li>• Deeper set installation on rough concrete not possible.</li> <li>• 230V/50/60Hz electrical connection required.</li> </ul>	1700 × 950 / 750 1800 × 1000 / 800

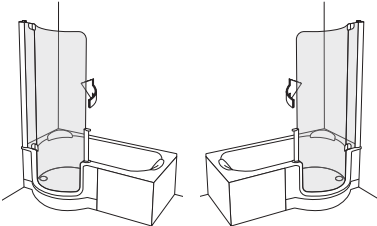
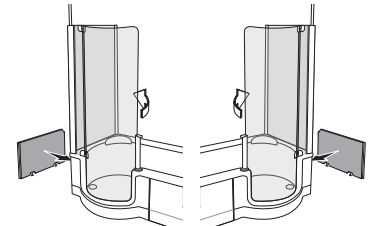
SHOWER AREA	Product description/ features	Height/ door height	Suitable for bathtub
left                      right			
<b>Shower door</b>	<ul style="list-style-type: none"> <li>• Please order bathtub extra.</li> </ul>	<b>2045</b> / 1920	All sizes
	<p><b>CUSTOM MEASUREMENTS</b> - Measurement sketch needed. fixed-part custom width (narrower or wider).</p>	<b>1900</b> / 1775 lower height	All sizes
<b>Shower door with side screen</b>	<ul style="list-style-type: none"> <li>• Please order bathtub extra.</li> <li>• Includes side screen with ceiling support.</li> <li>• Ceiling support extendable up to 700 mm.</li> <li>• Solid ceiling required for fixing the ceiling support.</li> </ul>	<b>2045</b> / 1920	1700 × 950 / 750 1800 × 1000 / 800
	<p><b>CUSTOM MEASUREMENTS</b> - Measurement sketch needed. Side screen custom width (narrower or wider).</p>	<b>1900</b> / 1775 lower height	1700 × 950 / 750 1800 × 1000 / 800

## IMPORTANT

- Shower door: Required installation height is total height + 40 mm.
- Shower door with side screen: Required installation height is total height + 100 mm.
- When installing the shower door on the already tiled wall a 12 mm compound bracket is required. See page 189.

Art. no.		Colour	Additional features		Seat and neck support <sup>2</sup>
T L					
Base price			Surcharge		
SHOWER AREA		WS White	A ART-Grip (optional)	E Inlet/drain/overflow <sup>1</sup> (optional)	WS White SB Silver
left	right			Flexible connection hose ¾" see page 189.	When the colour is not stated, execution will be in white (WS).
TLM1 01	TLM2 01	4,083	220	346	WS 0 SB 79
TLM1 04	TLM2 04	4,690			
TLA3 11	TLA4 11	7,827	-	346	WS 0 SB 79
TLA3 14	TLA4 14	8,433			

TWINLINE 1  
Shower bathtubs

Art. no.		Frame colour	Glazing	Glass finishing (optional)	Handle and hinge colour	
T L						
Base price			Surcharge			
SHOWER AREA		WS White LB Silver . . . Additional colours	MH High-gloss metal	EK Glass clear SA Satin	C ARTCLEAR GLAZING	. . same as frame <sup>2</sup> VC Chrome
left	right					
TL81 87	TL82 87	1,872	2,059	EK 0 SA -	211	.. 0 VC 0
TL81 85	TL82 85					
TL81 88	TL82 88	2,074	2,262			
TLS1 37	TLS2 37	2,826	3,109	EK 0 SA 351	417	.. 0 VC 0
TLS1 47	TLS2 47					
TLS1 35	TLS2 35					
TLS1 45	TLS2 45					
TLS1 88	TLS2 88	3,028	3,310			



### IMPORTANT

<sup>1</sup> In case of the integrated tub inlet a pipe interrupter type A2 according to EN 1717 is to be installed.

<sup>2</sup> Only VC chrome-plated available with MH high-gloss metal frames.

# TWINLINE 1 SKIRTS AND TILE SUBSTRATE

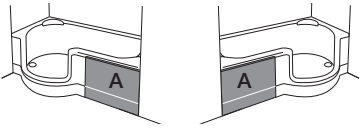
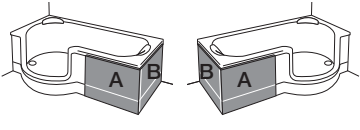
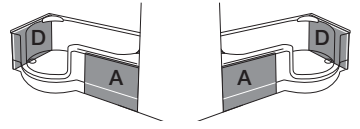
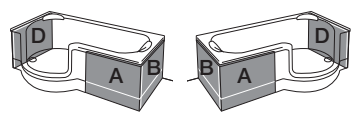
ARTWEGER price list 03/2023. For specialised trade outlets only. Suggested retail prices in EUR not including VAT. DIMENSIONS IN MILLIMETRES.

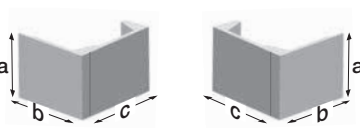
SHOWER AREA	Applications	Suitable for bathtub												
<p>left right</p> <p><b>Skirt 01</b> alcove installation</p> 	<ul style="list-style-type: none"> <li>The TWINLINE 1 bathtub can be lowered by exactly 110mm if required. (Installation on raw concrete). <b>If so required please indicate when ordering. Skirts with the ARTWALL or GLASS surfaces have to be adjusted to this requirement at the factory.</b></li> </ul>	<p>1700 × 950 / 750 1800 × 1000 / 800</p>												
<p><b>Skirt 02</b> corner installation</p> 	<ul style="list-style-type: none"> <li><b>Skirt 03, 04 and 06:</b> Requires shower door with side screen. With skirt D the desired surface is to be attached to the supplied tile substrate on site.</li> </ul>	<p>1700 × 950 / 750 1800 × 1000 / 800</p>												
<p><b>Skirt 03</b> corner installation</p> 		<p>1700 × 950 / 750 1800 × 1000 / 800</p>												
<p><b>Skirt 04</b> installation on straight wall</p> 		<p>1700 × 950 / 750 1800 × 1000 / 800</p>												
<p><b>Tile substrate</b> alcove installation</p> 	<ul style="list-style-type: none"> <li>Moulded EPS as substrate for tiling.</li> <li><b>Suitable for bathtub on left and right.</b></li> <li>Exactly matching form. Easy to assemble.</li> <li>Not suited for TWINLINE 1 AIR.</li> </ul>	<p>1700 1800</p>												
<p><b>Tile substrate</b> corner installation, installation on straight wall</p> 	<table border="0"> <tr> <td></td> <td style="text-align: center;"><b>a</b></td> <td style="text-align: center;"><b>b</b></td> <td style="text-align: center;"><b>c</b></td> </tr> <tr> <td><b>1700 × 950 / 750:</b></td> <td style="text-align: center;">510</td> <td style="text-align: center;">640</td> <td style="text-align: center;">730</td> </tr> <tr> <td><b>1800 × 1000 / 800:</b></td> <td style="text-align: center;">510</td> <td style="text-align: center;">740</td> <td style="text-align: center;">780</td> </tr> </table>		<b>a</b>	<b>b</b>	<b>c</b>	<b>1700 × 950 / 750:</b>	510	640	730	<b>1800 × 1000 / 800:</b>	510	740	780	<p>1700 × 950 / 750 1800 × 1000 / 800</p>
	<b>a</b>	<b>b</b>	<b>c</b>											
<b>1700 × 950 / 750:</b>	510	640	730											
<b>1800 × 1000 / 800:</b>	510	740	780											



Art. no.

Colour/decor

T L

□ □

Base price

SHOWER AREA left right	Plastic	ARTWALL 3.0		Glass
	WS White	WM White BT Concrete MB Beige glossy marble WG Glossy white RS Rust CY Canyon SC Slate	NB Stone beige NG Grey stone NH Light stone colour NV Stone Verdello EI Oak MG Grey glossy marble ML Light glossy marble	GH Glass clear AT Glass Anthracite BD Glass Bordeaux
TL0B 04	581		581	651
TL0B 05	622		622	692
TL0E 02	1,073		1,073	1,153
TL0E 03	1,150		1,150	1,230
TL0E 05	1,073		1,073	1,153
TL0E 06	1,150		1,150	1,230
TL0E 08	1,565		1,565	1,655
TL0E 09	1,678		1,678	1,768
. . Colour not specified				
TL0H 11	87			
TL0H 16	108			
TL0H 12	171			
TL0H 17	210			

TWINLINE 1  
Shower bathtubs

# TWINLINE 2

The bathtub of the future.

- Shower bathtub in modern linear design
- Choose between full-sized or partitioned door opening inwards
- Mechanical closure
- Certified adherence technique
- Wall profile with 3D adjustment and concealed silicone joint
- 6/8 mm single-pane safety glass
- Standard height 2110 mm or custom size
- Entry height of 180 mm, which can be reduced to 55 mm
- Optionally as Airpool



A special seal extends to just below the edge of the tub and holds the water safely in the tub even when full.



Due to the straight shape of the tub, TWINLINE 2 needs no more space than a conventional bathtub. A widening of the tub in the shower area ensures plenty of room for showering.



Clear stylistic elements with strong accents: The tub skirts are available in a high-quality white plastic version, with a glass skirt in the colours Glass clear, Bordeaux and Anthracite as well as in all of the ARTWALL colours. A special tile substrate allows individual tiling.



An ingenious mechanical locking system combines water spout with door lock, thus ensuring safety while bathing.

Artweger  
**TWIN:LINE 2**

artclear  
GLASS

CE

according to EN 14428  
and EN 14516







Swinging splash protection for the shower door of the TWINLINE 2 and ARTLIFT. Optional accessories. Can also be installed later.

**IMPORTANT**

# ACCESSORIES

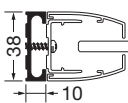
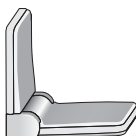
ARTWEGER price list 03/2023. For specialised trade outlets only.  
Suggested retail prices in EUR not including VAT. DIMENSIONS IN MILLIMETRES.

Art. no.	Colour
□ □ □ □ □ □ □ □	□ □
Base price	

	Art. no.	WS White LB Silver . . Additional colours	MH High-gloss metal . . Colour not specified
 <p><b>Compound bracket 10 mm</b> Height 1500 mm. Extends adjustment range of all products by 10 mm. Required when installing on already tiled wall.</p>	<b>T20P 32</b>	132	<b>MH</b> 145
 <p><b>Folding seat</b> Height 320 mm, width 385 mm, depth 92 mm. Capacity: 130 kg. Overhang: 335 mm. Colour Silver. Folding mechanism with motion damper and magnetic catch. For installation on tiled walls. <b>A load-bearing wall must be available to mount the seat.</b> For special types of walls such as aerated concrete the fixation materials have to be suitable ones recommended by the construction company.</p>	<b>T20B KS</b>	-	. . 957
 <p><b>Tub corner seat</b> Height 40 mm, width 566 mm, depth 290 mm. Capacity: 130 kg. Colour anthracite. Can also be retrofitted to existing TWINLINE 2 shower bathtubs. Can be removed at any time and easy to clean.</p>	<b>T20B ES</b>	-	. . 309
 <p><b>Backrest</b> Height 360 mm, width 300 mm, depth 20 mm. Colour anthracite. Can also be retrofitted to existing TWINLINE 2 shower bathtubs. Fixation with suction cups. Can be removed at any time and easy to clean.</p>	<b>T20B RL</b>	-	. . 219
 <p><b>Sealing tape</b> Length 3600 mm. For sealing and sound installation between the tub, the structure and the tiles. Including the tile tape.</p>	<b>W0 12</b>	-	. . 97

TWINLINE 2  
Shower bathtubs

## TWINLINE 2 DESIGN RECOMMENDATION

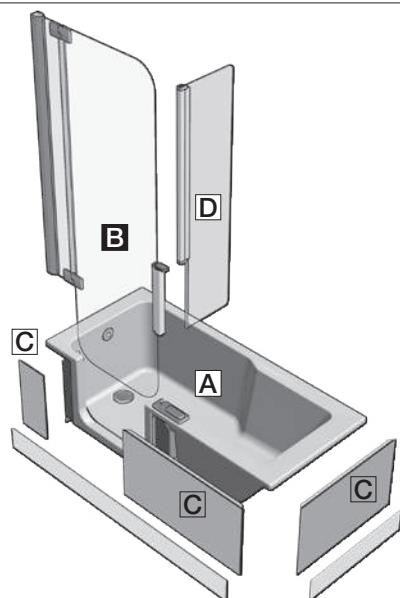

Corner installation left with shower door.	Art. no.	Prices in EUR
<b>Bathtub 1700 x 750 mm</b> <ul style="list-style-type: none"> <li>• Plastic tub in white.</li> <li>• Drain, overflow included.</li> <li>• With pre-mounted assembly angles and tub feet.</li> </ul>	<b>A</b> T2W1 01 WS	3,688
<b>Shower door</b> <ul style="list-style-type: none"> <li>• Colour: high-gloss metal</li> <li>• Glazing: glass clear incl. ARTCLEAR GLASS</li> </ul>	<b>B</b> T281 8F MHEK C VC	1,560
<b>Skirt 02 (optional)</b> <ul style="list-style-type: none"> <li>• Plastic skirt in white.</li> </ul>	<b>C</b> T2B1 22 WS	1,203
<b>Pivoting splashguard (optional)</b> <ul style="list-style-type: none"> <li>• Can also be installed later.</li> </ul>	<b>D</b> T2L1 Z1 MHEK C	548
<b>Total price in EUR:</b>		<b>6,999</b>

### IMPORTANT

- We will gladly send you the documents in hard copy on request.

# TWINLINE 2 DIMENSIONS

ARTWEGER price list 03/2023. For specialised trade outlets only. DIMENSIONS IN MILLIMETRES.

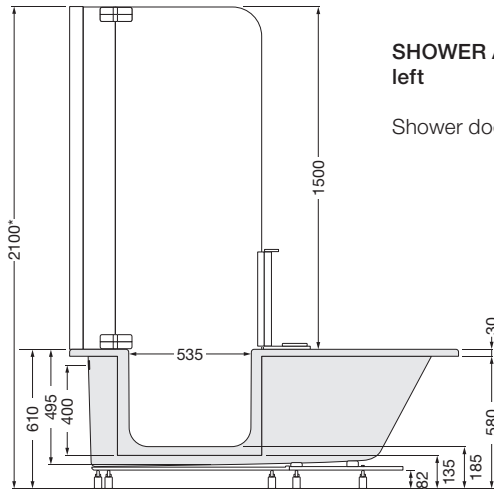

**SHOWER AREA left**

Shower door

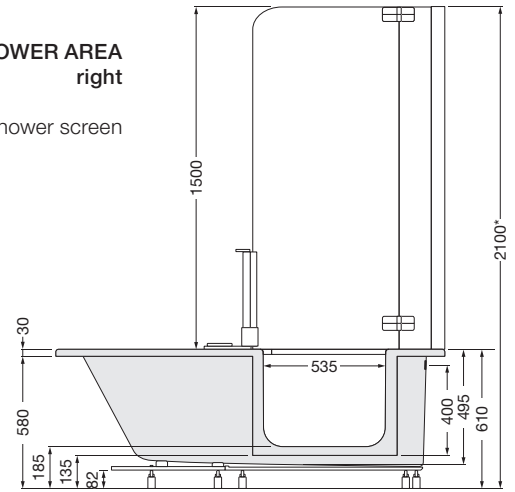

**SHOWER AREA right**

Bathtub door, shower screen

\* Height 2100 mm or custom size.

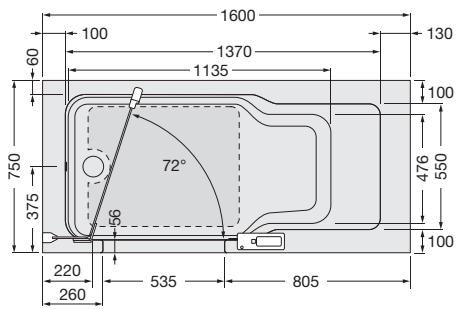

**TWINLINE 2**  
**1600 x 750**  
depth 495

Tub capacity  
ca. 180 litres.

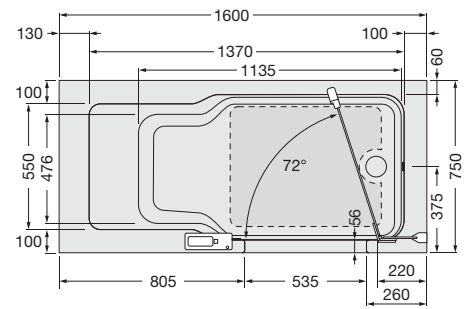

**TWINLINE 2**  
**1700 x 750**  
depth 495

Tub capacity  
ca. 200 litres.

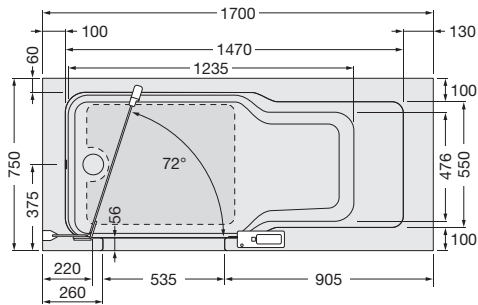

**TWINLINE 2**  
**1700 x 800**  
depth 495

Tub capacity  
ca. 220 litres.

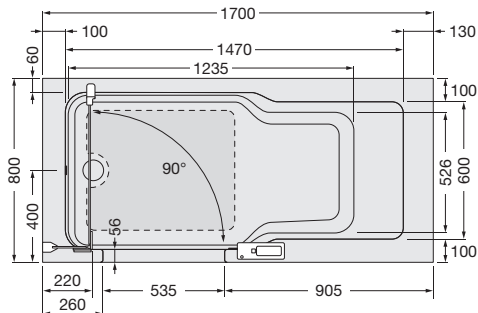
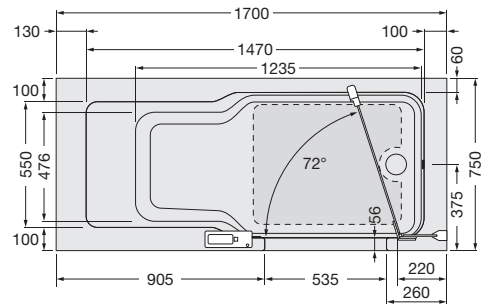

**TWINLINE 2**  
**1800 x 800**  
depth 495

Tub capacity  
ca. 240 litres.

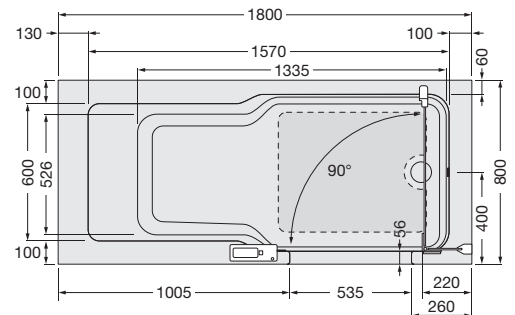
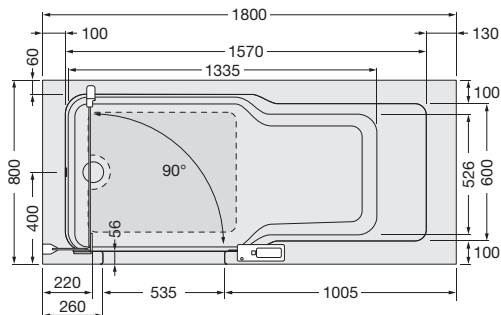
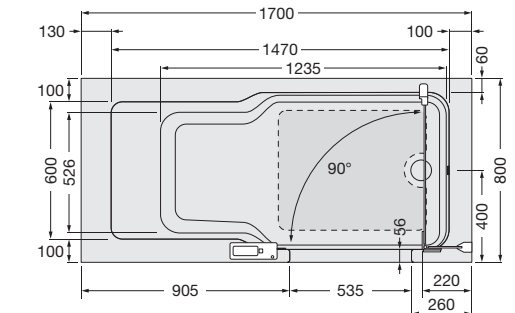

# TWINLINE 2 OVERVIEW OF PRODUCT FEATURES

ARTWEGER price list 03/2023. For specialised trade outlets only.

## Bathtub

- Plastic tub in white.
- Drain, overflow chrome-plated (standard) - Inlet/drain/overflow chrome-plated (optional).
- With pre-mounted assembly angles and tub feet. Including height-adjustable feet.
- With mechanical closure for installation without electricity.
- Optional: ART-Grip - anti-slip zone anti-slip coating class C according to DIN 51097.
- The control element is, as a standard, positioned on the front side of the bathtub.
- Tub capacity: Approximate average water consumption of a full bath with one person.

## Shower door, bathtub door

- Door opens to inside. Entrance width 535 mm. Handle with locking mechanism. Single-pane safety glass 8 mm.
- When installing the shower door on the already tiled wall a 10 mm compound bracket is required. See page 197.

## Shower door with side screen

- Door opens to inside. Entrance width 535 mm. Handle with locking mechanism. Single-pane safety glass 8 mm.
- Includes side screen with ceiling support. Single-pane safety glass 6 mm. Ceiling support extendable up to 700 mm. Solid ceiling required for fixing the ceiling support.
- When installing the shower door on the already tiled wall a 10 mm compound bracket is required. See page 197.

## Pivoting splashguard next to shower door (optional)

- Single-pane safety glass 6 mm.
- Can also be installed later.
- Cannot be combined with shower screen for bathtub door.

## Shower screen next to bathtub door (optional)

- Can be opened inwards as well as outwards. Entrance width 535 mm. Handle with locking mechanism. Single-pane safety glass 6 mm.
- Can also be installed later.
- Cannot be combined with moveable splash screen.

## Skirt

- To allow for maintenance and service we recommend installing TWINLINE 2 skirting or tile backing board.
- Please order tub skirt or tile carrier separately. See page 206.

## TWINLINE 2 AIR - The other kind of Airpool.

- Control element built into tub's edge.
- Due to the air system used, no regular disinfection is necessary. Automatic blowing-out of the jets after every use of bath and shower.
- 24 × Air jets in bottom area. 2 × LED coloured light with 7 colours. Air membrane pump 45 W.
- 230V/50/60Hz electrical connection required.
- Power consumption max. 50 W. Standby 8 W.
- Deeper set installation on rough concrete not possible.

ART-Grip Skid-resistant zone (scheme)



TWINLINE 2 AIR arrangement of equipment

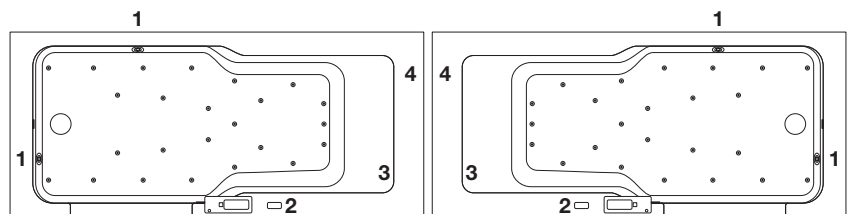

1 = LED coloured light, 2 = control element AIR,  
3 = electrical connection and electronic control, 4 = membrane pump

ARTWEGER price list 03/2023. For specialised trade outlets only. Suggested retail prices in EUR not including VAT.  
DIMENSIONS IN MILLIMETRES.

TWINLINE 2 - with continuous door, total height 2110 mm		Length x width	Art. no.	Price in EUR
 <p><b>TWINLINE 2 Shower bathtub</b></p> <p><b>High-gloss metal, glass clear, with integrated inlet, plastic tub and skirt in white</b></p>	1700 x 750 Alcove installation left	<b>T2W1 01 WSE</b> <b>T281 8F MHEK VC</b> <b>T2B1 12 WS</b>	3,849 1,349 679	
	1700 x 750 Alcove installation right	<b>T2W2 01 WSE</b> <b>T282 8F MHEK VC</b> <b>T2B2 12 WS</b>	3,849 1,349 679	
	1700 x 750 Corner installation left	<b>T2W1 01 WSE</b> <b>T281 8F MHEK VC</b> <b>T2B1 22 WS</b>	3,849 1,349 1,203	
	1700 x 750 Corner installation right	<b>T2W2 01 WSE</b> <b>T282 8F MHEK VC</b> <b>T2B2 22 WS</b>	3,849 1,349 1,203	



# TWINLINE 2

Winged door 8 mm / Side screen and splashguard 6 mm ESG

ARTWEGER price list 03/2023. For specialised trade outlets only. Suggested retail prices in EUR not including VAT.  
DIMENSIONS IN MILLIMETRES.

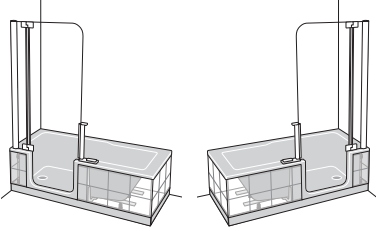
SHOWER AREA		Product description/ features	Length x width
left	right		
<b>Bathtub</b>		<ul style="list-style-type: none"> <li>• With mechanical closure.</li> <li>• Please order shower door extra.</li> </ul>	1600 x 750
			1700 x 750
		<ul style="list-style-type: none"> <li>• <b>TWINLINE 2 AIR</b> with mechanical closure.</li> <li>• Please order shower door extra.</li> <li>• <b>Installation of an Artweger tub skirt or a tile carrier is required for maintenance and service. Please order tub skirt separately. See page 206. Deeper set installation on rough concrete not possible.</b></li> <li>• 230V/50/60Hz electrical connection required.</li> </ul>	1700 x 800
			1800 x 800
			1600 x 750
			1700 x 750
			1700 x 800
			1800 x 800

Why not make provisions for the future? By purchasing an ARTLIFT pre-installation set your customer can equip their shower bathtub with an ARTLIFT seat lift at any time!

You can find the ARTLIFT pre-installation set on page 212.

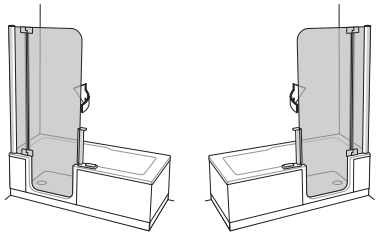
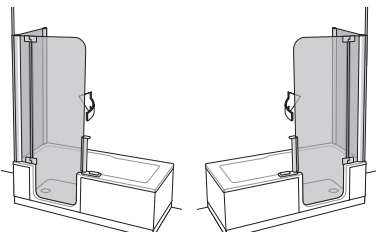
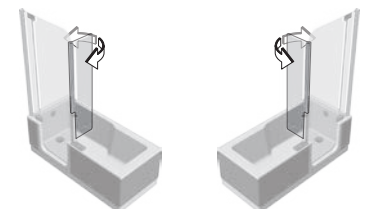
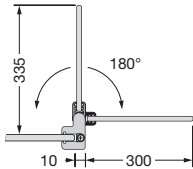
SHOWER AREA		Product description/ features	Height/ door height	Suitable for bathtub
left	right			
<b>Shower door</b>		<ul style="list-style-type: none"> <li>• Please order bathtub extra.</li> </ul>	<b>2110</b> / 1970	All sizes
				
		<b>CUSTOM MEASUREMENTS</b> - Measurement sketch needed. fixed-part custom width (narrower or wider). Triangular cut-out on request. <b>Surcharge for custom heights up to a maximum of 2110 mm.</b>		
<b>Shower door with side screen</b>		<ul style="list-style-type: none"> <li>• Please order bathtub extra.</li> <li>• Includes side screen with ceiling support.</li> <li>• Ceiling support extendable up to 700 mm.</li> <li>• Solid ceiling required for fixing the ceiling support.</li> </ul>	<b>2110</b> / 1970	1600 x 750
				1700 x 750
				1700 x 800
				1800 x 800
		<b>CUSTOM MEASUREMENTS</b> - Measurement sketch needed. Side screen custom width (narrower or wider). <b>Surcharge for custom heights up to a maximum of 2110 mm.</b>		
<b>Pivoting splashguard</b>		<ul style="list-style-type: none"> <li>• Optional accessory</li> <li>• Single-pane safety glass 6 mm.</li> <li>• Can also be installed later.</li> </ul>	<b>1350</b>	All sizes
				
				
		<b>CUSTOM HEIGHT</b> - Custom widths not available. <b>Surcharge for triangular cut-outs.</b>		

## IMPORTANT

- Shower door: Required installation height is total height + 40 mm.
- Shower door with side screen: Required installation height is total height + 100 mm.
- When installing the shower door on the already tiled wall a 10 mm compound bracket is required. See page 197.



Art. no.		Colour		Additional features	
T 2					
		Base price		Surcharge	
SHOWER AREA		WS White		A ART-Grip (optional)	E Inlet/drain/overflow <sup>1</sup> (optional)
left	right				
T2W1 03 T2W1 01	T2W2 03 T2W2 01	3,688		220	161
T2W1 05 T2W1 04	T2W2 05 T2W2 04	3,757			
T2R1 13 T2R1 11	T2R2 13 T2R2 11	7,489		-	161
T2R1 15 T2R1 14	T2R2 15 T2R2 14	7,558			

TWINLINE 2  
Shower bathtubs

Art. no.		Frame colour		Glazing	Glass finishing (optional)	Handle and hinge colour	
T 2							
		Base price			Surcharge		
SHOWER AREA		WS White LB Silver . . Additional colours	MH High-gloss metal	EK Glass clear	C ARTCLEAR GLAZING	. . same as frame <sup>2</sup> VC Chrome	
left	right						
T281 8F	T282 8F	1,226	1,349	0	211	VC	0 0
T281 88	T282 88	1,432	1,554				
		414	455				
T2S1 3F T2S1 3F	T2S2 3F T2S2 3F	2,031	2,234	0	417	VC	0 0
T2S1 4F T2S1 4F	T2S2 4F T2S2 4F						
T2S1 88	T2S2 88	2,239	2,443				
		498	548				
T2L1 Z1	T2L2 Z1	481	481	0	67		-
T2L1 88	T2L2 88	576	576				
		278	278				

### IMPORTANT

- <sup>1</sup> Incl. connection hose 1/2", 1500 mm. In case of the integrated tub inlet a pipe interrupter type A2 according to EN 1717 is to be installed.  
<sup>2</sup> Only VC chrome-plated available with MH high-gloss metal frames.

# TWINLINE 2

Bathtub door 8 mm / Shower screen and side screen 6 mm ESG

ARTWEGER price list 03/2023. For specialised trade outlets only. Suggested retail prices in EUR not including VAT.  
DIMENSIONS IN MILLIMETRES.

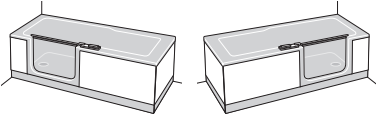
SHOWER AREA	Product description/ features	Length x width
left                      right		
<b>Bathtub with bathtub door</b>		
	<ul style="list-style-type: none"> <li>• With mechanical closure.</li> </ul>	1600 x 750 1700 x 750 1700 x 800 1800 x 800
	<ul style="list-style-type: none"> <li>• <b>TWINLINE 2 AIR</b> with mechanical closure.</li> <li>• <b>Installation of an Artweger tub skirt or a tile carrier is required for maintenance and service. Please order tub skirt separately. See page 206. Deeper set installation on rough concrete not possible.</b></li> <li>• 230V/50/60Hz electrical connection required.</li> </ul>	1600 x 750 1700 x 750 1700 x 800 1800 x 800

Why not make provisions for the future? By purchasing an ARTLIFT pre-installation set your customer can equip their shower bathtub with an ARTLIFT seat lift at any time!

You can find the ARTLIFT pre-installation set on page 216.

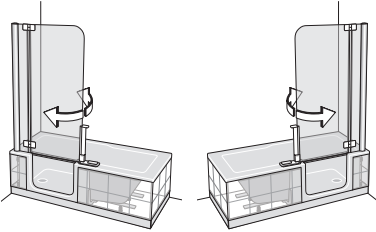
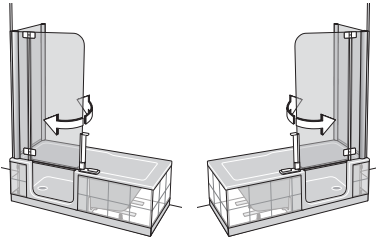
SHOWER AREA	Product description/ features	Height/ door height	Suitable for bathtub
left                      right			
<b>Shower screen</b>			
	<ul style="list-style-type: none"> <li>• Please order bathtub extra.</li> <li>• Cannot be combined with moveable splash screen.</li> </ul>	<b>2110</b> / 1500	All sizes
	<b>CUSTOM MEASUREMENTS</b> - Measurement sketch needed. fixed-part custom width (narrower or wider). Triangular cut-out on request. <b>Surcharge for custom heights 1986 - 2109 mm/door height 1376 - 1499 mm.</b>		
<b>Shower screen with side screen</b>			
	<ul style="list-style-type: none"> <li>• Please order bathtub extra.</li> <li>• Includes side screen with ceiling support.</li> <li>• Ceiling support extendable up to 700 mm.</li> <li>• Solid ceiling required for fixing the ceiling support.</li> <li>• Cannot be combined with moveable splash screen.</li> </ul>	<b>2110</b> / 1500	1600 x 750 1700 x 750 1700 x 800 1800 x 800
	<b>CUSTOM MEASUREMENTS</b> - Measurement sketch needed. Side screen custom width (narrower or wider). <b>Surcharge for custom heights 1986 - 2109 mm/door height 1376 - 1499 mm.</b>		

## IMPORTANT

- Shower screen: Required installation height is total height + 40 mm.
- Shower screen with side screen: Required installation height is total height + 100 mm.
- When installing the shower door on the already tiled wall a 10 mm compound bracket is required. See page 197.

Art. no.		Colour	Additional features		Glass finishing (optional)
T 2					
		Base price	Surcharge		
SHOWER AREA		<b>WS</b> White	<b>A</b> ART-Grip (optional)	<b>E</b> Inlet/drain/overflow <sup>1</sup> (optional)	<b>C</b> ARTCLEAR GLASS included
left	right	<ul style="list-style-type: none"> <li>• Tub in white</li> <li>• Bathtub door high-gloss metal</li> <li>• Glass clear incl. ARTCLEAR GLASS</li> </ul>			
T2GM1 03	T2GM2 03	4,215	220	161	0
T2GM1 01	T2GM2 01				
T2GM1 05	T2GM2 05	4,281			
T2GM1 04	T2GM2 04				
T2GA1 13	T2GA2 13	8,013	-	161	0
T2GA1 11	T2GA2 11				
T2GA1 15	T2GA2 15	8,083			
T2GA1 14	T2GA2 14				

TWINLINE 2  
Shower bathtubs

Art. no.		Frame colour	Glazing	Glass finishing (optional)	Hinge colour
T 2					
		Base price	Surcharge		
SHOWER AREA		<b>MH</b> High-gloss metal <b>WS</b> White <b>LB</b> Silver . . . Additional colours	<b>EK</b> Glass clear	<b>C</b> ARTCLEAR GLAZING	. . same as frame <sup>2</sup> <b>VC</b> Chrome
left	right				
T2G81 82	T2G82 82	1,255	0	211	VC 0
T2G81 88	T2G82 88	1,462			
		455			
T2GS1 32	T2GS2 32	2,125	0	417	VC 0
T2GS1 32	T2GS2 32				
T2GS1 42	T2GS2 42	2,329			
T2GS1 42	T2GS2 42				
T2GS1 88	T2GS2 88	548			

### IMPORTANT

<sup>1</sup> Incl. connection hose 1/2", 1500 mm. In case of the integrated tub inlet a pipe interrupter type A2 according to EN 1717 is to be installed.

<sup>2</sup> Only VC chrome-plated available with MH high-gloss metal frames.

# TWINLINE 2 SKIRTS AND TILE SUBSTRATE

ARTWEGER price list 03/2023. For specialised trade outlets only. Suggested retail prices in EUR not including VAT. DIMENSIONS IN MILLIMETRES.

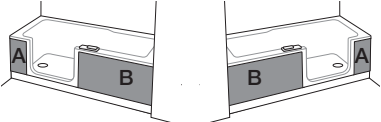
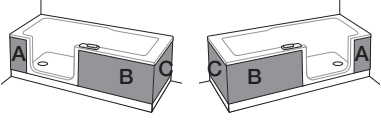
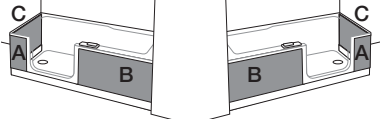
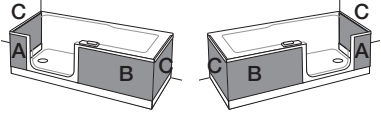
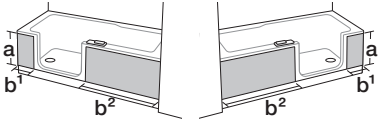
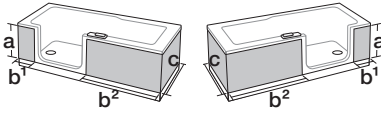
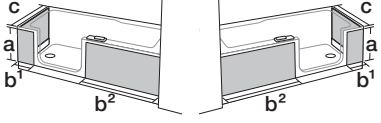
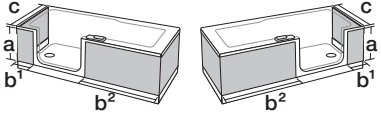
SHOWER AREA	Product description	Suitable for bathtub																									
<p>left                      right</p> <p><b>Skirt 01</b> alcove installation</p> 		<p>1600 1700 1800</p>																									
<p><b>Skirt 02</b> corner installation</p> 		<p>1600 × 750 1700 × 750 1700 × 800 1800 × 800</p>																									
<p><b>Skirt 03</b> corner installation</p> 	<ul style="list-style-type: none"> <li>• <b>Skirt 03 and 04 suitable for:</b> <ul style="list-style-type: none"> <li>- Shower door with side screen</li> <li>- Bathtub door</li> <li>- Bathtub door and shower screen with side screen</li> </ul> </li> </ul>	<p>1600 × 750 1700 × 750 1700 × 800 1800 × 800</p>																									
<p><b>Skirt 04</b> installation on straight wall</p> 		<p>1600 × 750 1700 × 750 1700 × 800 1800 × 800</p>																									
<p><b>Tile substrate 01</b> alcove installation</p> 	<ul style="list-style-type: none"> <li>• Mounting plate with attachment.</li> <li>• Exact positioning is adjustable on site.</li> <li>• Suitable for tiles with a thickness of at most 10 mm.</li> </ul>	<p>1600 1700 1800</p>																									
<p><b>Tile substrate 02</b> corner installation</p> 	<table border="0"> <thead> <tr> <th></th> <th>a</th> <th>b<sup>1</sup></th> <th>b<sup>2</sup></th> <th>c</th> </tr> </thead> <tbody> <tr> <td><b>1600 × 750:</b></td> <td>445</td> <td>210</td> <td>755</td> <td>750</td> </tr> <tr> <td><b>1700 × 750:</b></td> <td>445</td> <td>210</td> <td>855</td> <td>750</td> </tr> <tr> <td><b>1700 × 800:</b></td> <td>445</td> <td>210</td> <td>855</td> <td>800</td> </tr> <tr> <td><b>1800 × 800:</b></td> <td>445</td> <td>210</td> <td>955</td> <td>800</td> </tr> </tbody> </table>		a	b <sup>1</sup>	b <sup>2</sup>	c	<b>1600 × 750:</b>	445	210	755	750	<b>1700 × 750:</b>	445	210	855	750	<b>1700 × 800:</b>	445	210	855	800	<b>1800 × 800:</b>	445	210	955	800	<p>1600 × 750 1700 × 750 1700 × 800 1800 × 800</p>
	a	b <sup>1</sup>	b <sup>2</sup>	c																							
<b>1600 × 750:</b>	445	210	755	750																							
<b>1700 × 750:</b>	445	210	855	750																							
<b>1700 × 800:</b>	445	210	855	800																							
<b>1800 × 800:</b>	445	210	955	800																							
<p><b>Tile substrate 03</b> corner installation</p> 	<ul style="list-style-type: none"> <li>• <b>Tile substrate 03 and 04 suitable for:</b> <ul style="list-style-type: none"> <li>- Shower door with side screen</li> <li>- Bathtub door</li> <li>- Bathtub door and shower screen with side screen</li> </ul> </li> </ul>	<p>1600 × 750 1700 × 750 1700 × 800 1800 × 800</p>																									
<p><b>Tile substrate 04</b> installation on straight wall</p> 		<p>1600 × 750 1700 × 750 1700 × 800 1800 × 800</p>																									

SHOWER AREA		Plastic	ARTWALL	Glass	
left	right	<b>WS</b> White 	<b>WM</b> White <b>BT</b> Concrete <b>MB</b> Beige glossy marble <b>WG</b> Glossy white <b>RS</b> Rust <b>CY</b> Canyon <b>SC</b> Slate	<b>NB</b> Stone beige <b>NG</b> Grey stone <b>NH</b> Light stone colour <b>NV</b> Stone Verdello <b>EI</b> Oak <b>MG</b> Grey glossy marble <b>ML</b> Light glossy marble	<b>GH</b> Glass clear <b>AT</b> Glass Anthracite <b>BD</b> Glass Bordeaux
T2B1 11	T2B2 11	679	679	799	
T2B1 12	T2B2 12				
T2B1 13	T2B2 13				700
T2B1 21	T2B2 21	1,203	1,203	1,335	
T2B1 22	T2B2 22				
T2B1 24	T2B2 24				1,221
T2B1 23	T2B2 23	1,243	1,243	1,375	
T2B1 31	T2B2 31	1,203	1,203	1,335	
T2B1 32	T2B2 32				
T2B1 34	T2B2 34				1,221
T2B1 33	T2B2 33	1,243	1,243	1,375	
T2B1 41	T2B2 41	1,718	1,718	1,879	
T2B1 42	T2B2 42				
T2B1 44	T2B2 44				1,754
T2B1 43	T2B2 43	1,779	1,779	1,940	
		. . . Colour not specified			
T2F1 11	T2F2 11	458			
T2F1 12	T2F2 12	458			
T2F1 13	T2F2 13	464			
T2F1 21	T2F2 21	819			
T2F1 22	T2F2 22	819			
T2F1 24	T2F2 24	831			
T2F1 23	T2F2 23	831			
T2F1 31	T2F2 31	819			
T2F1 32	T2F2 32	819			
T2F1 34	T2F2 34	831			
T2F1 33	T2F2 33	831			
T2F1 41	T2F2 41	1,177			
T2F1 42	T2F2 42	1,177			
T2F1 44	T2F2 44	1,199			
T2F1 43	T2F2 43	1,199			

# ARTLIFT

Shower. Bathe. Seat lift.

- Shower bathtub with a comfort lifting seat
- Choose between full-sized or partitioned door opening inwards
- Mechanical closure
- Certified adhesion technique
- Wall profile with 3D adjustment and concealed silicone joint
- 6/8 mm single-pane safety glass
- Standard height 2110 mm or custom size
- Entry height of 180 mm, which can be reduced to 55 mm
- Optionally as Airpool
- Including ARTCLEAR GLASS without surcharge



As soon as you press a key the seat begins to move either up or down. When you release the key the seat stops automatically.



In the upmost position the backrest is vertical and in the optimal position for getting in. Now you can safely and easily be seated.



Your mobility guarantee in the bathroom. ARTLIFT from Artweger is the best example of what a modern bathroom should provide: Clear design, innovative technology and convincing comfort. The ARTLIFT unites the benefits of the unique shower and bath combination with a comfortable seat lift. In this way Artweger has been the first to create an all-inclusive mobility solution for the bathroom.

**Artweger®**

artclear  
GLASS

CE

according to EN 14428  
and EN 14516



When lowering, the backrest slowly adjusts to the angle of the tub, the seat always remains horizontal.



You do not need the ARTLIFT? Fold away the seat and use your shower/bathtub in your accustomed manner for bathing and showering.





Being prepared can be so elegant. The comfortable backrest is delivered with the invisibly integrated pre-installation set.

# ACCESSORIES

ARTWEGER price list 03/2023. For specialised trade outlets only.  
Suggested retail prices in EUR not including VAT. DIMENSIONS IN MILLIMETRES.

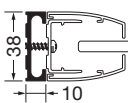
Art. no.	Colour
□ □ □ □ □ □ □ □	□ □
Base price	

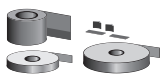
	Art. no.	MH High-gloss metal	Colour not specified
 <p><b>Compound bracket 10 mm</b> Height 1500 mm. Extends adjustment range of all products by 10 mm. Required when installing on already tiled wall.</p>	<b>ALOP 42</b>	145	-
 <p><b>Seat lift for retro-fitting.</b> Capacity up to 120 kg. Overhang: 330 mm. Height 600 mm, width 330 mm, depth 120/90 mm. Colour anthracite. <b>Addition to an ARTLIFT with pre-installation set.</b></p>	<b>ALHS 01</b>	-	6,821
 <p><b>Tub corner seat</b> Capacity: 130 kg. Height 40 mm, width 566 mm, depth 290 mm. Colour anthracite. Can also be retrofitted to existing ARTLIFT shower bathtubs. Can be removed at any time and easy to clean.</p>	<b>ALOB ES</b>	-	309
 <p><b>Sealing tape</b> Length 3600 mm. For sealing and sound installation between the tub, the structure and the tiles. Including the tile tape.</p>	<b>W012</b>	-	97

ARTLIFT  
Shower bathtubs

## ARTLIFT DESIGN RECOMMENDATION

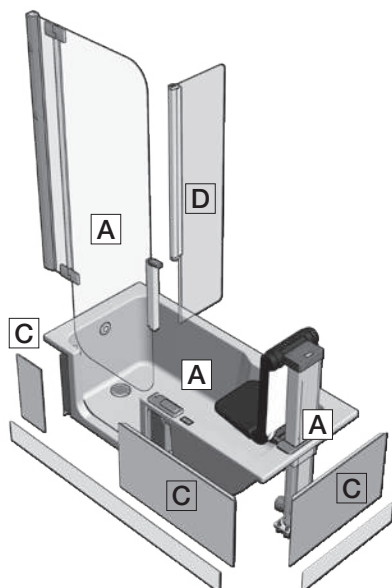

Corner installation left	Art. no.	Prices in EUR
<b>ARTLIFT 1700 x 750 mm with seat lift</b>	<b>A</b> AL1 01	12,510
<b>Shower door</b>		
• Colour: high-gloss metal		
• Glazing: glass clear incl. ARTCLEAR GLASS		
<b>Bathtub with seat lift</b>		
• Plastic tub in white.		
• Drain, overflow included.		
• With pre-mounted assembly angles and tub feet.		
• Seat lift included.		
<b>Skirt 02</b>	<b>C</b> ALB1 22 WS	1,203
• Plastic skirt in white.		
<b>Pivoting splashguard (optional)</b>	<b>D</b> ALL1 Z1 MHEKC	548
• Can also be installed later.		
<b>Total price in EUR:</b>		<b>14,261</b>

### IMPORTANT

- We will gladly send you the documents in hard copy on request.

# ARTLIFT DIMENSIONS

ARTWEGER price list 03/2023. For specialised trade outlets only. DIMENSIONS IN MILLIMETRES.

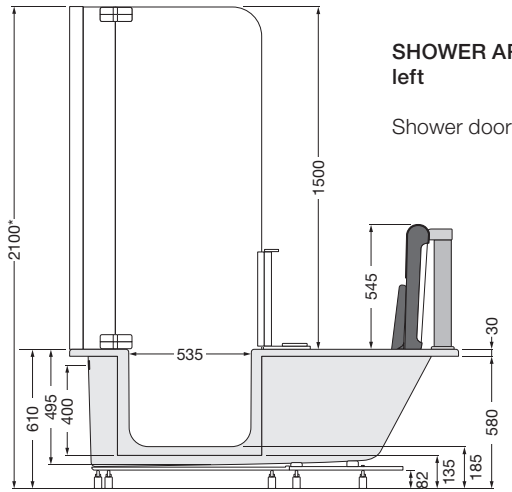

**SHOWER AREA left**

Shower door

**SHOWER AREA right**

Bathtub door, shower screen

\* Height 2100 mm or custom size.

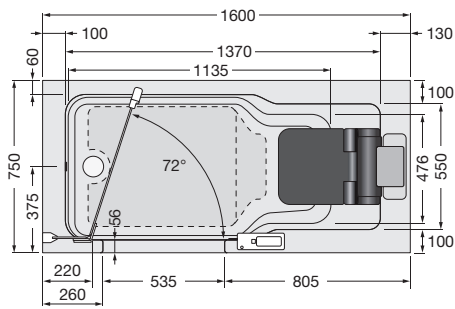
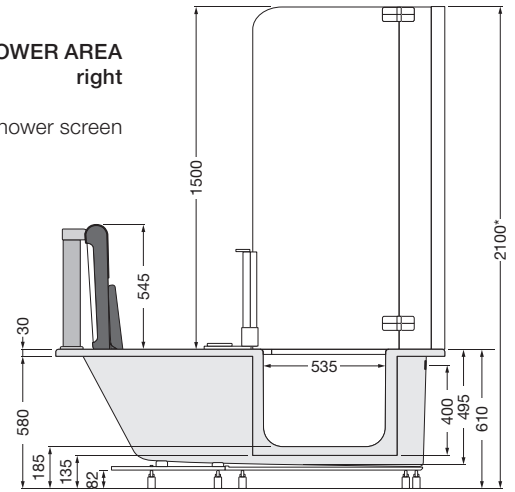

**ARTLIFT  
1600 x 750**  
depth 495

Tub capacity  
ca. 180 litres.

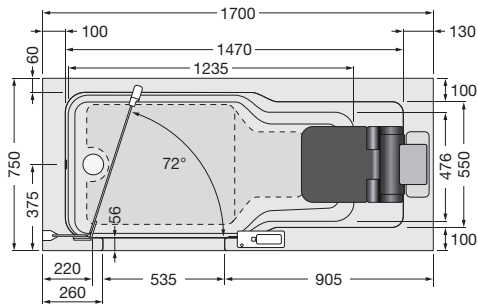
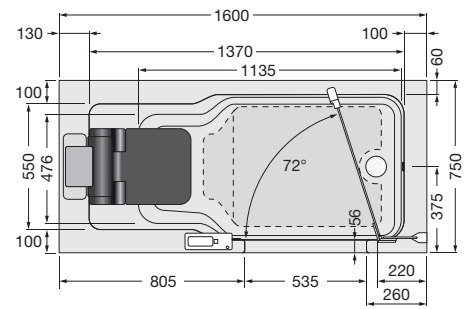

**ARTLIFT  
1700 x 750**  
depth 495

Tub capacity  
ca. 200 litres.

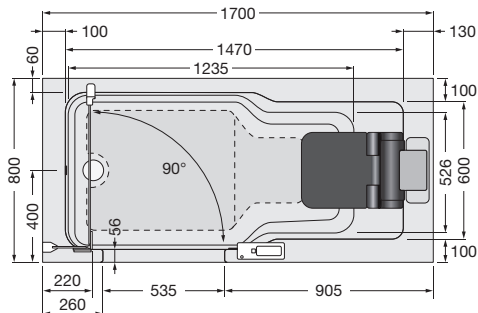
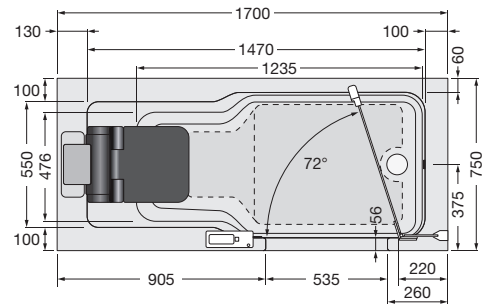

**ARTLIFT  
1700 x 800**  
depth 495

Tub capacity  
ca. 220 litres.

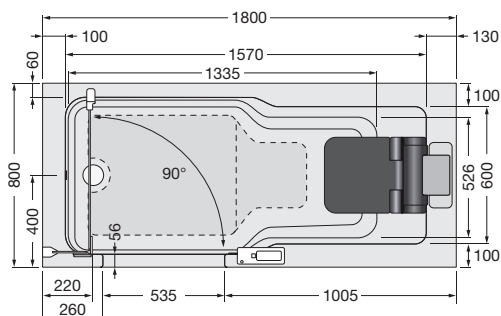
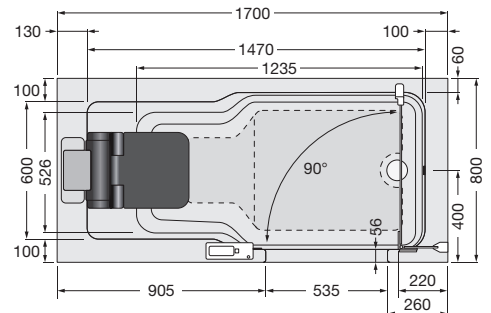

**ARTLIFT  
1800 x 800**  
depth 495

Tub capacity  
ca. 240 litres.

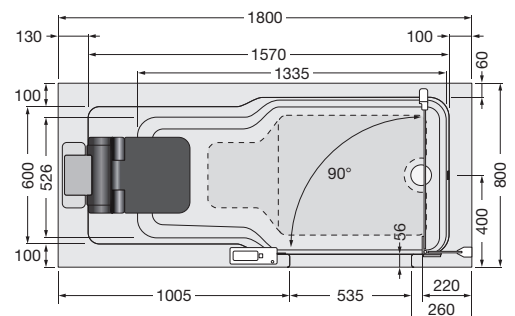



# ARTLIFT OVERVIEW OF PRODUCT FEATURES

ARTWEGER price list 03/2023. For specialised trade outlets only.

## Pre-installation ARTLIFT

- Installations to be executed on-site according to DIN 1986, DIN 1988, DIN 4109, and VDE.
- Separate mains supply line H05-VV-F (flexible line) over a RCD  $I_{\Delta n} \leq 30\text{mA}$ . For connection a cable of approx. 3 m should be provided.
- Main switch as protection, bipolar, 20A, with min. 3 mm contact opening, controlled by light switch, e.g. with control display. Fuse switch FI, bipolar RCD  $I_{\Delta n} \leq 30\text{mA}$ .
- Potential compensation line, 4 mm<sup>2</sup> (Cu), for connection to standard earthing clip.
- Water inlet and outlet according to DIN 1986 and DIN 1986 as with a normal bathtub.
- In case of the integrated tub inlet (optional equipment) a pipe interrupter (type A2) according to EN 1717 is to be installed.
- Tub capacity: Approximate average water consumption of a full bath with one person.

## Bathtub

- Plastic tub in white. The tub is prepared for the installation of a seat lift and its control element.
- Control element built into tub's edge. Blind cover in the case of a pre-installation set.. Detachable backrest with a high quality surface.
- Drain, overflow chrome-plated (standard). Inlet/drain/overflow chrome-plated (optional).
- With pre-mounted assembly angles and tub feet. Including height-adjustable feet.

## Pre-installation / seat lift

- Electrical supply with 230V/50/60Hz is required. Operating voltage of the motor 24V DC, output max. 120W. Standby 7 W.
- The pre-installation set enables retro-fitting of a seat lift. Seat lift for retro-fitting see page 209.
- Lifting speed ca. 8 mm/sec.

## Shower door, bathtub door

- Door opens to inside. Entrance width 535 mm. Handle with locking mechanism. Single-pane safety glass 8 mm incl. ARTCLEAR GLASS.
- When installing the shower door on the already tiled wall a 10 mm compound bracket is required. See page 209.

## Shower door with side screen

- Door opens to inside. Entrance width 535 mm. Handle with locking mechanism. Single-pane safety glass 8 mm incl. ARTCLEAR GLASS.
- Includes side screen with ceiling support. Single-pane safety glass 6 mm incl. ARTCLEAR GLASS. Ceiling support extendable up to 700 mm. Solid ceiling required for fixing the ceiling support.
- When installing the shower door on the already tiled wall a 10 mm compound bracket is required. See page 209.

## Pivoting splashguard next to shower door (optional)

- Single-pane safety glass 6 mm incl. ARTCLEAR GLASS.
- Can also be installed later. Cannot be combined with shower screen for bathtub door.

## Shower screen next to bathtub door (optional)

- Can be opened inwards as well as outwards. Entrance width 535 mm. Handle with locking mechanism. Single-pane safety glass 6 mm incl. ARTCLEAR GLASS.
- Can also be installed later. Cannot be combined with moveable splash screen.

## Skirt

- Installation of an Artweger tub skirt or a tile carrier is required for maintenance and service. Please order tub skirt or tile carrier separately. See page 218.

## ARTLIFT AIR - The other kind of Airpool.

- Control element built into tub's edge.
- Due to the air system used, no regular disinfection is necessary. Automatic blowing-out of the jets after every use of bath and shower.
- 24 x air jets in bottom area. 2 x LED coloured light with 7 colours. Air membrane pump 45 W.
- 230V/50/60Hz electrical connection required.
- Power consumption max. 170 W (ARTLIFT max. 120W, AIR max. 50W). Standby 8 W.
- Deeper set installation on rough concrete not possible.

## ART-Grip Skid-resistant zone (scheme)

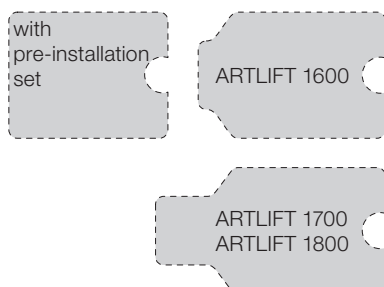

## TWINLINE 2 AIR arrangement of equipment

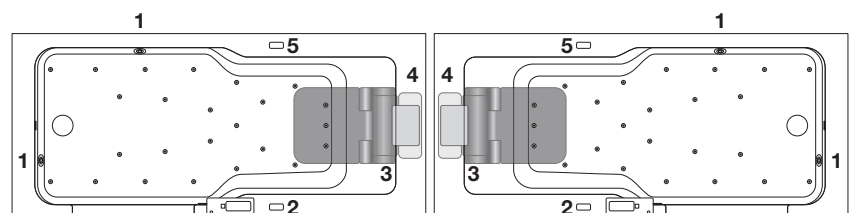

1 = LED coloured light, 2 = control element ARTLIFT, 3 = control element AIR, 4 = electrical connection and electronic control, 5 = membrane pump

# ARTLIFT WITH PRE-INSTALLATION SET

Winged door 8 mm  
Side screen and splashguard 6 mm ESG

ARTWEGER price list 03/2023. For specialised trade outlets only. Suggested retail prices in EUR not including VAT.  
DIMENSIONS IN MILLIMETRES.

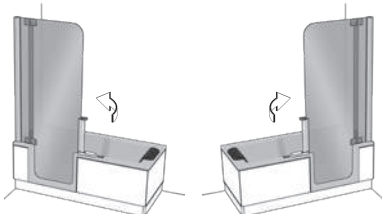
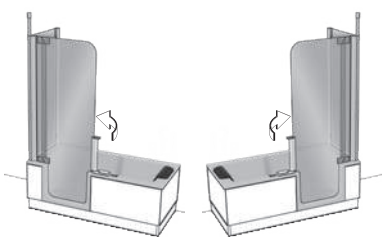
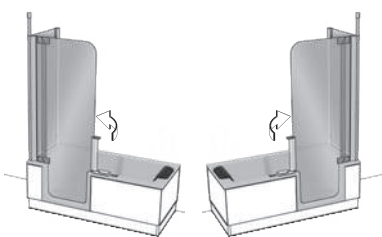
SHOWER AREA	Product description/ features	Height/ door height	Length x width
left                      right			
<b>ARTLIFT with pre-installation set, shower door and bathtub</b>  	<ul style="list-style-type: none"> <li>• With mechanical closure.</li> <li>• Electrical supply with 230V/50/60Hz is required.</li> </ul>	<b>2110</b> / 1970	1600 × 750 1700 × 750 1700 × 800 1800 × 800
	<b>CUSTOM MEASUREMENTS</b> - Measurement sketch needed. fixed-part custom width (narrower or wider). Triangular cut-out on request. <b>Surcharge for custom heights up to a maximum of 2110 mm.</b>		
<b>ARTLIFT with pre-installation set, shower door with side screen and bathtub</b>  	<ul style="list-style-type: none"> <li>• With mechanical closure.</li> <li>• Electrical supply with 230V/50/60Hz is required.</li> <li>• Ceiling support extendable up to 700 mm. Solid ceiling required for fixing the ceiling support.</li> </ul>	<b>2110</b> / 1970	1600 × 750 1700 × 750 1700 × 800 1800 × 800
	<b>CUSTOM MEASUREMENTS</b> - Measurement sketch needed. fixed-part custom width (narrower or wider). Triangular cut-out on request. <b>Surcharge for custom heights up to a maximum of 2110 mm.</b>		
<b>ARTLIFT with pre-installation set, shower door with side screen and bathtub</b>  	<ul style="list-style-type: none"> <li>• With mechanical closure.</li> <li>• Electrical supply with 230V/50/60Hz is required.</li> <li>• Ceiling support extendable up to 700 mm. Solid ceiling required for fixing the ceiling support.</li> </ul>	<b>2110</b> / 1970	1600 × 750 1700 × 750 1700 × 800 1800 × 800
	<b>CUSTOM MEASUREMENTS</b> - Measurement sketch needed. Side screen custom width (narrower or wider). <b>Surcharge for custom heights up to a maximum of 2110 mm.</b>		

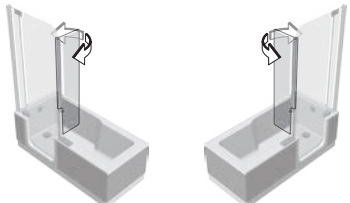
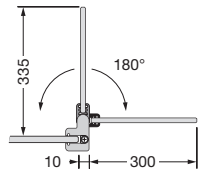
SHOWER AREA	Product description/ features	Height/ door height	Suitable for bathtub
left                      right			
<b>Pivoting splashguard</b>  	<ul style="list-style-type: none"> <li>• Optional accessory</li> <li>• Single-pane safety glass 6 mm.</li> <li>• Can also be installed later.</li> </ul>	<b>1350</b>	All sizes
			
<b>CUSTOM HEIGHT</b> - Custom widths not available. <b>Surcharge for triangular cut-outs.</b>			

## IMPORTANT

- Installation of an Artweger tub skirt or a tile carrier is required for maintenance and service. See page 218.
  - Shower door: Required installation height is total height + 40 mm.
  - Shower door with side screen: Required installation height is total height + 100 mm.

Art. no.		Additional features		
A L				
Base price		Surcharge		
SHOWER AREA		• Tub in white • Shower door high-gloss metal • Glass clear incl. ARTCLEAR GLASS	A ART-Grip (optional)	E Inlet/drain/overflow <sup>1</sup> (optional)
left	right			
ALA 03 ALA 01	ALB 03 ALB 01	6,359	220	161
ALA 05 ALA 04	ALB 05 ALB 04	6,427		
ALA 88	ALB 88	6,632		
		455		
ALAR 13 ALAR 11	ALBR 13 ALBR 11	10,159	-	161
ALAR 15 ALAR 14	ALBR 15 ALBR 14	10,227		
ALAR 88	ALBR 88	10,432		
		455		
ALC 03 ALC 01	ALD 03 ALD 01	7,416	220	161
ALC 05 ALC 04	ALD 05 ALD 04	7,484		
ALC 88	ALD 88	7,688		
		548		
ALCR 13 ALCR 11	ALDR 13 ALDR 11	11,216	-	161
ALCR 15 ALCR 14	ALDR 15 ALDR 14	11,284		
ALCR 88	ALDR 88	11,488		
		548		

ARTLIFT  
Shower bathtubs

Art. no.		Frame colour	Glazing	Glass finishing (optional)
A L				
Base price		Surcharge		
SHOWER AREA		MH High-gloss metal	EK Glass clear	C ARTCLEAR GLASS included
left	right			
ALL1 Z1	ALL2 Z1	548	0	0
ALL1 88	ALL2 88	643		
		278		

### IMPORTANT

- Incl. connection hose 1/2", 1500 mm. In case of the integrated tub inlet a pipe interrupter type A2 according to EN 1717 is to be installed.

# ARTLIFT WITH SEAT LIFT

Winged door 8 mm  
Side screen and splashguard 6 mm ESG

ARTWEGER price list 03/2023. For specialised trade outlets only. Suggested retail prices in EUR not including VAT.  
DIMENSIONS IN MILLIMETRES.

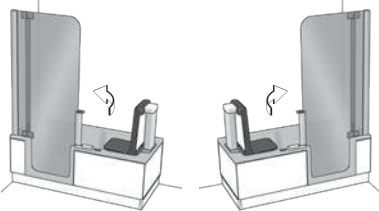
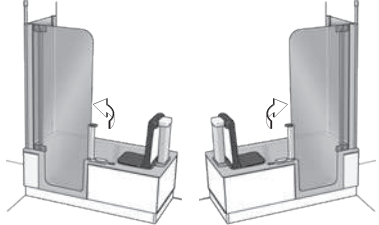
SHOWER AREA	Product description/ features	Height/ door height	Length x width
left                      right			
<b>ARTLIFT with seat lift, shower door and bathtub</b>  	<ul style="list-style-type: none"> <li>• With mechanical closure.</li> <li>• Electrical supply with 230V/50/60Hz is required.</li> </ul>	<b>2110</b> / 1970	1600 x 750 1700 x 750 1700 x 800 1800 x 800
<b>CUSTOM MEASUREMENTS</b> - Measurement sketch needed. fixed-part custom width (narrower or wider). Triangular cut-out on request. <b>Surcharge for custom heights up to a maximum of 2110 mm.</b>			
	<ul style="list-style-type: none"> <li>• <b>ARTLIFT AIR</b></li> <li>• With mechanical closure.</li> <li>• Electrical supply with 230V/50/60Hz is required.</li> <li>• <b>Deeper set installation on rough concrete not possible.</b></li> </ul>	<b>2110</b> / 1970	1600 x 750 1700 x 750 1700 x 800 1800 x 800
<b>CUSTOM MEASUREMENTS</b> - Measurement sketch needed. fixed-part custom width (narrower or wider). Triangular cut-out on request. <b>Surcharge for custom heights up to a maximum of 2110 mm.</b>			
<b>ARTLIFT with seat lift, shower door with side screen and bathtub</b>  	<ul style="list-style-type: none"> <li>• With mechanical closure.</li> <li>• Electrical supply with 230V/50/60Hz is required.</li> <li>• Ceiling support extendable up to 700 mm. Solid ceiling required for fixing the ceiling support.</li> </ul>	<b>2110</b> / 1970	1600 x 750 1700 x 750 1700 x 800 1800 x 800
<b>CUSTOM MEASUREMENTS</b> - Measurement sketch needed. Side screen custom width (narrower or wider). <b>Surcharge for custom heights up to a maximum of 2110 mm.</b>			
	<ul style="list-style-type: none"> <li>• <b>ARTLIFT AIR</b></li> <li>• With mechanical closure.</li> <li>• Electrical supply with 230V/50/60Hz is required.</li> <li>• Ceiling support extendable up to 700 mm. Solid ceiling required for fixing the ceiling support.</li> <li>• <b>Deeper set installation on rough concrete not possible.</b></li> </ul>	<b>2110</b> / 1970	1600 x 750 1700 x 750 1700 x 800 1800 x 800
<b>CUSTOM MEASUREMENTS</b> - Measurement sketch needed. Side screen custom width (narrower or wider). <b>Surcharge for custom heights up to a maximum of 2110 mm.</b>			

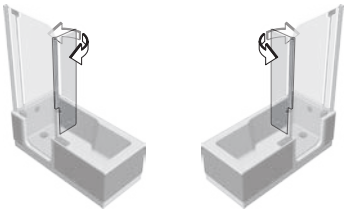
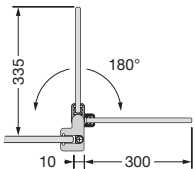
SHOWER AREA	Product description/ features	Height/ door height	Suitable for bathtub
left                      right			
<b>Pivoting splashguard</b>  	<ul style="list-style-type: none"> <li>• Optional accessory</li> <li>• Single-pane safety glass 6 mm.</li> <li>• Can also be installed later.</li> </ul>	<b>1350</b>	All sizes
			
<b>CUSTOM HEIGHT</b> - Custom widths not available. <b>Surcharge for triangular cut-outs.</b>			

## IMPORTANT

- Installation of an Artweger tub skirt or a tile carrier is required for maintenance and service. See page 218.
  - Shower door: Required installation height is total height + 40 mm.
  - Shower door with side screen: Required installation height is total height + 100 mm.

Art. no.		Additional features		
A L				
Base price		Surcharge		
SHOWER AREA		• Tub in white • Shower door high-gloss metal • Glass clear incl. ARTCLEAR GLASS	A ART-Grip (optional)	E Inlet/drain/overflow <sup>1</sup> (optional)
left	right			
AL1 03 AL1 01	AL2 03 AL2 01	12,510	220	161
AL1 05 AL1 04	AL2 05 AL2 04	12,579		
AL1 88	AL2 88	12,784		
		455		
AL1R 13 AL1R 11	AL2R 13 AL2R 11	16,311	-	161
AL1R 15 AL1R 14	AL2R 15 AL2R 14	16,380		
AL1R 88	AL2R 88	16,585		
		455		
AL3 03 AL3 01	AL4 03 AL4 01	13,567	220	161
AL3 05 AL3 04	AL4 05 AL4 04	13,636		
AL3 88	AL4 88	13,840		
		548		
AL3R 13 AL3R 11	AL4R 13 AL4R 11	17,368	-	161
AL3R 15 AL3R 14	AL4R 15 AL4R 14	17,437		
AL3R 88	AL4R 88	17,641		
		548		

ARTLIFT  
Shower bathtubs

Art. no.		Frame colour	Glazing	Glass finishing (optional)
A L				
Base price		Surcharge		
SHOWER AREA		MH High-gloss metal	EK Glass clear	C ARTCLEAR GLASS included
left	right			
ALL1 Z1	ALL2 Z1	548	0	0
ALL1 88	ALL2 88	643		
		278		

### IMPORTANT

- Incl. connection hose 1/2", 1500 mm. In case of the integrated tub inlet a pipe interrupter type A2 according to EN 1717 is to be installed.

# ARTLIFT WITH PRE-INSTALLATION SET / SEAT LIFT

Bathtub door 8 mm  
Shower screen and side screen  
6 mm ESG

ARTWEGER price list 03/2023. For specialised trade outlets only. Suggested retail prices in EUR not including VAT.  
DIMENSIONS IN MILLIMETRES.

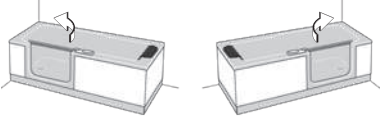
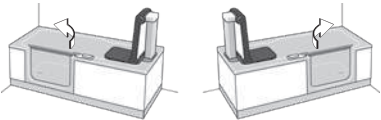
SHOWER AREA		Product description/ features	Height/ door height	Length × width
left	right			
<b>ARTLIFT with pre-installation set, bathtub door and bathtub</b> 		<ul style="list-style-type: none"> <li>• With mechanical closure.</li> <li>• Electrical supply with 230V/50/60Hz is required.</li> </ul>	<b>610</b>	1600 × 750 1700 × 750 1700 × 800 1800 × 800
		<ul style="list-style-type: none"> <li>• <b>ARTLIFT AIR</b></li> <li>• With mechanical closure.</li> <li>• Electrical supply with 230V/50/60Hz is required.</li> <li>• <b>Deeper set installation on rough concrete not possible.</b></li> </ul>		1600 × 750 1700 × 750 1700 × 800 1800 × 800
<b>ARTLIFT with seat lift, bathtub door and bathtub</b> 		<ul style="list-style-type: none"> <li>• With mechanical closure.</li> <li>• Electrical supply with 230V/50/60Hz is required.</li> </ul>	<b>610</b>	1600 × 750 1700 × 750 1700 × 800 1800 × 800
		<ul style="list-style-type: none"> <li>• <b>ARTLIFT AIR</b></li> <li>• With mechanical closure.</li> <li>• Electrical supply with 230V/50/60Hz is required.</li> <li>• <b>Deeper set installation on rough concrete not possible.</b></li> </ul>		1600 × 750 1700 × 750 1700 × 800 1800 × 800

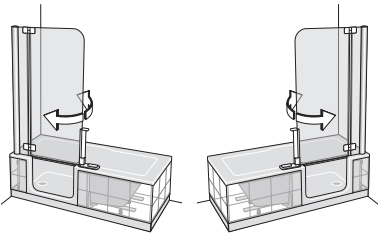
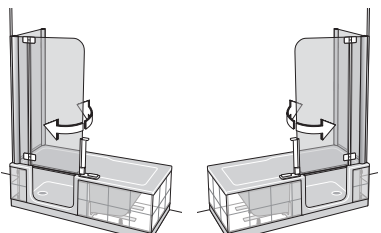
SHOWER AREA		Product description/ features	Height/ door height	Suitable for bathtub
left	right			
<b>Shower screen</b> 		<ul style="list-style-type: none"> <li>• Please order bathtub extra.</li> <li>• Cannot be combined with moveable splash screen.</li> </ul>	<b>2110</b> / 1500	All sizes
		<b>CUSTOM MEASUREMENTS</b> - Measurement sketch needed. fixed-part custom width (narrower or wider). Triangular cut-out on request. <b>Surcharge for custom heights 1986 - 2109 mm/door height 1376 - 1499 mm.</b>		
<b>Shower screen with side screen</b> 		<ul style="list-style-type: none"> <li>• Please order bathtub extra.</li> <li>• Includes side screen with ceiling support.</li> <li>• Ceiling support extendable up to 700 mm.</li> <li>• Solid ceiling required for fixing the ceiling support.</li> <li>• Cannot be combined with moveable splash screen.</li> </ul>	<b>2110</b> / 1500	1600 × 750 1700 × 750 1700 × 800 1800 × 800
		<b>CUSTOM MEASUREMENTS</b> - Measurement sketch needed. Side screen custom width (narrower or wider). <b>Surcharge for custom heights 1986 - 2109 mm/door height 1376 - 1499 mm.</b>		

## IMPORTANT

- Installation of an Artweger tub skirt or a tile carrier is required for maintenance and service. See page 218.
  - Shower screen: Required installation height is total height + 40 mm.
  - Shower screen with side screen: Required installation height is total height + 100 mm.

Art. no.		Additional features		
A L				
		Base price	Surcharge	
SHOWER AREA		<ul style="list-style-type: none"> <li>• Tub in white</li> <li>• Bathtub door high-gloss metal</li> <li>• Glass clear incl. ARTCLEAR GLASS</li> </ul>	A ART-Grip (optional)	E Inlet/drain/overflow <sup>1</sup> (optional)
left	right			
ALGMA 03 ALGMA 01	ALGMB 03 ALGMB 01	5,347	220	161
ALGMA 05 ALGMA 04	ALGMB 05 ALGMB 04	5,416		
ALGAA 13 ALGAA 11	ALGAB 13 ALGAB 11	9,148	-	161
ALGAA 15 ALGAA 14	ALGAB 15 ALGAB 14	9,218		
ALG1 03 ALG1 01	ALG2 03 ALG2 01	11,499	220	161
ALG1 05 ALG1 04	ALG2 05 ALG2 04	11,568		
ALG1R 13 ALG1R 11	ALG2R 13 ALG2R 11	15,300	-	161
ALG1R 15 ALG1R 14	ALG2R 15 ALG2R 14	15,369		

ARTLIFT  
Shower bathtubs

Art. no.		Frame colour	Glazing	Glass finishing (optional)	Hinge colour
A L					
		Base price	Surcharge		
SHOWER AREA		MH High-gloss metal	EK Glass clear	C ARTCLEAR GLASS included	VC Chrome
left	right				
ALG81 82	ALG82 82	1,466	0	0	0
ALG81 88	ALG82 88	1,673			
		455			
ALGS1 32 ALGS1 32	ALGS2 32 ALGS2 32	2,542	0	0	0
ALGS1 42 ALGS1 42	ALGS2 42 ALGS2 42				
ALGS1 88	ALGS2 88	2,746			
		548			

### IMPORTANT

- Incl. connection hose 1/2", 1500 mm. In case of the integrated tub inlet a pipe interrupter type A2 according to EN 1717 is to be installed.

# ARTLIFT SKIRTS AND TILE SUBSTRATE

ARTWEGER price list 03/2023. For specialised trade outlets only. Suggested retail prices in EUR not including VAT. DIMENSIONS IN MILLIMETRES.

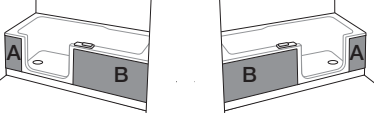
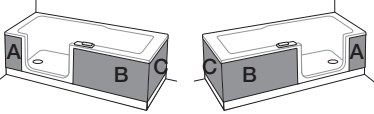
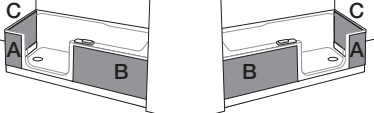
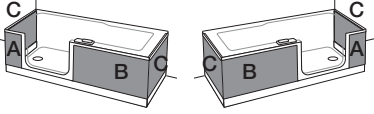
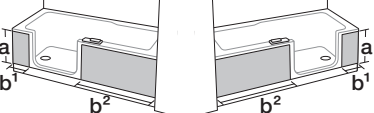
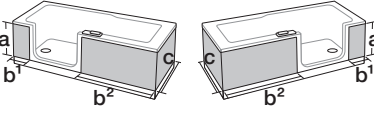
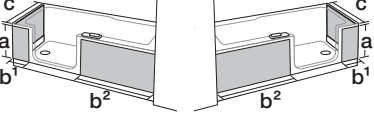
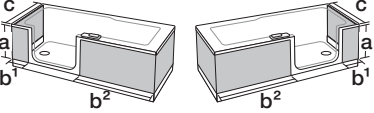
SHOWER AREA	Product description	Suitable for bathtub																									
<p>left                      right</p> <p><b>Skirt 01</b> alcove installation</p> 		<p>1600</p> <p>1700</p> <p>1800</p>																									
<p><b>Skirt 02</b> corner installation</p> 		<p>1600 × 750</p> <p>1700 × 750</p> <p>1700 × 800</p> <p>1800 × 800</p>																									
<p><b>Skirt 03</b> corner installation</p> 	<ul style="list-style-type: none"> <li>• <b>Skirt 03 and 04 suitable for:</b> <ul style="list-style-type: none"> <li>- Shower door with side screen</li> <li>- Bathtub door</li> <li>- Bathtub door and shower screen with side screen</li> </ul> </li> </ul>	<p>1600 × 750</p> <p>1700 × 750</p> <p>1700 × 800</p> <p>1800 × 800</p>																									
<p><b>Skirt 04</b> installation on straight wall</p> 		<p>1600 × 750</p> <p>1700 × 750</p> <p>1700 × 800</p> <p>1800 × 800</p>																									
<p><b>Tile substrate 01</b> alcove installation</p> 	<ul style="list-style-type: none"> <li>• Mounting plate with attachment.</li> <li>• Exact positioning is adjustable on site.</li> <li>• Suitable for tiles with a thickness of at most 10 mm.</li> </ul>	<p>1600</p> <p>1700</p> <p>1800</p>																									
<p><b>Tile substrate 02</b> corner installation</p> 	<table border="0"> <thead> <tr> <th></th> <th>a</th> <th>b<sup>1</sup></th> <th>b<sup>2</sup></th> <th>c</th> </tr> </thead> <tbody> <tr> <td><b>1600 × 750:</b></td> <td>445</td> <td>210</td> <td>755</td> <td>750</td> </tr> <tr> <td><b>1700 × 750:</b></td> <td>445</td> <td>210</td> <td>855</td> <td>750</td> </tr> <tr> <td><b>1700 × 800:</b></td> <td>445</td> <td>210</td> <td>855</td> <td>800</td> </tr> <tr> <td><b>1800 × 800:</b></td> <td>445</td> <td>210</td> <td>955</td> <td>800</td> </tr> </tbody> </table>		a	b <sup>1</sup>	b <sup>2</sup>	c	<b>1600 × 750:</b>	445	210	755	750	<b>1700 × 750:</b>	445	210	855	750	<b>1700 × 800:</b>	445	210	855	800	<b>1800 × 800:</b>	445	210	955	800	<p>1600 × 750</p> <p>1700 × 750</p> <p>1700 × 800</p> <p>1800 × 800</p>
	a	b <sup>1</sup>	b <sup>2</sup>	c																							
<b>1600 × 750:</b>	445	210	755	750																							
<b>1700 × 750:</b>	445	210	855	750																							
<b>1700 × 800:</b>	445	210	855	800																							
<b>1800 × 800:</b>	445	210	955	800																							
<p><b>Tile substrate 03</b> corner installation</p> 	<ul style="list-style-type: none"> <li>• <b>Tile substrate 03 and 04 suitable for:</b> <ul style="list-style-type: none"> <li>- Shower door with side screen</li> <li>- Bathtub door</li> <li>- Bathtub door and shower screen with side screen</li> </ul> </li> </ul>	<p>1600 × 750</p> <p>1700 × 750</p> <p>1700 × 800</p> <p>1800 × 800</p>																									
<p><b>Tile substrate 04</b> installation on straight wall</p> 		<p>1600 × 750</p> <p>1700 × 750</p> <p>1700 × 800</p> <p>1800 × 800</p>																									



A L

□ □

Base price

SHOWER AREA		Plastic	ARTWALL	Glass	
left	right	WS White	WM White BT Concrete MB Beige glossy marble WG Glossy white RS Rust CY Canyon SC Slate	NB Stone beige NG Grey stone NH Light stone colour NV Stone Verdello EI Oak MG Grey glossy marble ML Light glossy marble	GH Glass clear AT Glass Anthracite BD Glass Bordeaux
ALB1 11	ALB2 11	679		679	799
ALB1 12	ALB2 12				
ALB1 13	ALB2 13				
ALB1 21	ALB2 21	1,203		1,203	1,335
ALB1 22	ALB2 22				
ALB1 24	ALB2 24				
ALB1 23	ALB2 23	1,243		1,243	1,375
ALB1 31	ALB2 31	1,203		1,203	1,335
ALB1 32	ALB2 32				
ALB1 34	ALB2 34				
ALB1 33	ALB2 33	1,243		1,243	1,375
ALB1 41	ALB2 41	1,718		1,718	1,879
ALB1 42	ALB2 42				
ALB1 44	ALB2 44				
ALB1 43	ALB2 43	1,779		1,779	1,940
		. . . Colour not specified			
ALF1 11	ALF2 11	458		458	
ALF1 12	ALF2 12				
ALF1 13	ALF2 13				
ALF1 21	ALF2 21	819		819	
ALF1 22	ALF2 22				
ALF1 24	ALF2 24				
ALF1 23	ALF2 23	831			
ALF1 31	ALF2 31	819		819	
ALF1 32	ALF2 32				
ALF1 34	ALF2 34				
ALF1 33	ALF2 33	831			
ALF1 41	ALF2 41	1,177		1,177	
ALF1 42	ALF2 42				
ALF1 44	ALF2 44				
ALF1 43	ALF2 43	1,199			

# ARTWALL 3.0

New bathroom made easy!

- Wall-panels for an instant improvement without the need to tile. Glueing onto existing, professionally sealed tiles or walls.
- Robust surface, waterproof and easy to process
- Fire protection class B2 according to DIN 4102
- **Exact marrying of the wall panels and the corresponding profiles has to be done during on-site assembly. Appropriate tool required. Take care of positioning of fittings. Please order profiles and surface adhesive separately.**
- **ARTWALL surface adhesive is universally applicable for all substrates that are fully load-bearing, flat, dry, free of dust and grease, sealed against moisture and free of adhesion-reducing substances.**

## ARTWALL 3.0 COMPACT

- Compact panel 3 mm
- 2500 × 1250 mm
- Routing and folding technique for profile-free corner connections not possible
- Oversized dimension of 2520 × 1280 mm



3 mm thin aluminium composite panels (TREND decors) or compact panels (COMPACT decors) with robust surface.



Matt smooth surface, hygienic and particularly easy to clean (marble and white in smooth, high-gloss surface).

**Artweger**

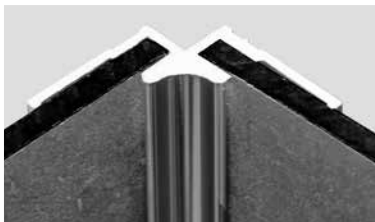

The slim connection and end profiles made of aluminium are available in the colours high-gloss metal and matt black.

## ARTWALL 3.0 TREND

- Aluminium composite panel 3 mm
- 2550 × 1000 mm and 2550 × 1500 mm
- Dimensional tolerance ± 5 mm



The ARTWALL 3.0 wall panels are adhered directly to the existing tiles or wall surface. ARTWALL 3.0 is available in various colors and designs and can be elegantly integrated into your current bathroom. And the best thing about it is ARTWALL 3.0 saves time and money – costly retiling is not necessary.



Only for TREND decors: panel and corner joints possible without visible aluminium profiles.

## ARTWALL 3.0 colours and decors

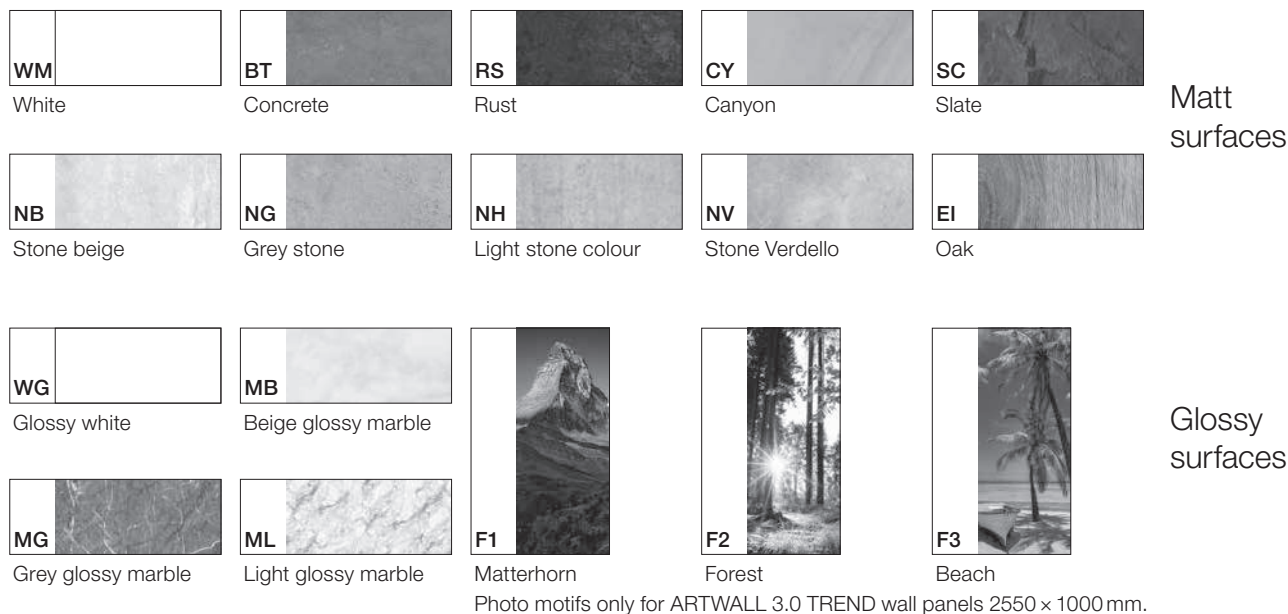

### Attention:

When installing ARTWALL 3.0 on existing tiles, a custom measurement for the shower screen may be required. If the ARTWALL 3.0 is installed over the existing wall covering on an existent shower tub, the installation dimensions of the shower tub are reduced by the panel thickness of 3 mm and by the thickness of the surface adhesive used. Therefore the tub installation dimensions are to be measured after the ARTWALL 3.0 has been installed.

- ① ARTWALL 3.0 incl. surface adhesive
- ② Tiled wall

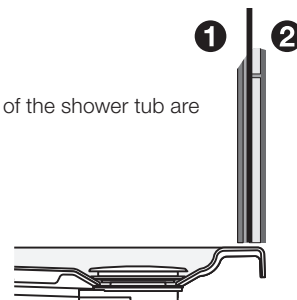

ARTWALL 3.0  
Wall panels

## ARTWALL 3.0 DESIGN RECOMMENDATION WITH WALL PANEL TREND



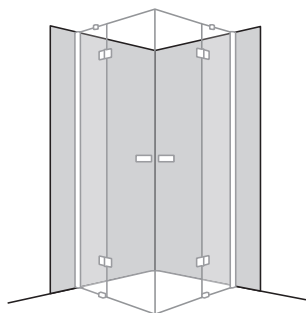

### Corner installation



Width 900 × 900 mm. Height 2000 mm.  
Projection to the shower screen 100 mm left and 100 mm right.

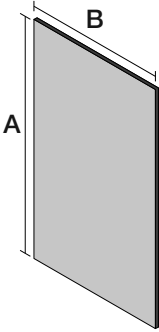

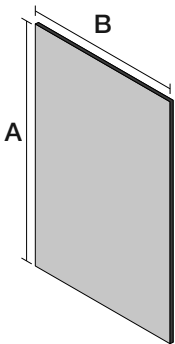

Components	Art. no.	Price/pc.	Pieces	Prices in EUR
<b>Wall panel TREND</b>				
Height 2550 mm, width 1000 mm	<b>A3T 6Z NB</b>	301	2	602
<b>frames</b>				
End-piece profile	<b>A3P 2Z MH</b>	51	2	102
Inner corner profile	<b>A3P 3Z MH</b>	51	1	51
<b>Surface adhesive*</b>	<b>A30 02</b>	89	2	178
<b>Total price in EUR:</b>				<b>933</b>

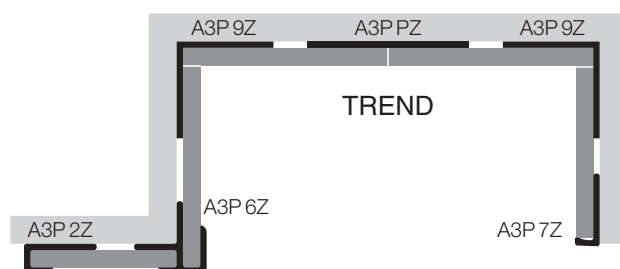
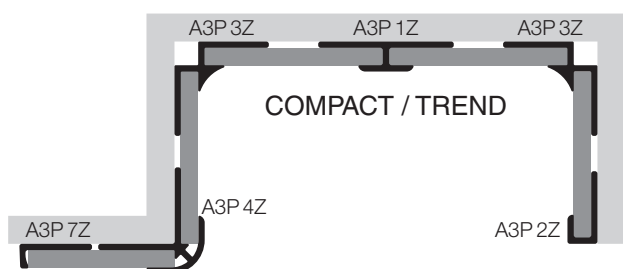
\* 2 x Art. no. **A30 02** for width 1000 mm.

ARTWALL 3.0		Colour	Art. no.	Price in EUR
 <p><b>Wall panel COMPACT</b> A = 2500 × B = 1250 mm</p> <ul style="list-style-type: none"> <li>• Compact panel 3 mm</li> <li>• Not suitable for Artweger Zero and Artweger Protect adhesion technology.</li> </ul>	White	A3C DZ WM	291	
	Concrete	A3C DZ BT		
	Beige glossy marble	A3C DZ MB	291	
	Glossy white	A3C DZ WG		
 <p><b>Wall panel TREND</b> A = 2550 × B = 1000 mm</p> <ul style="list-style-type: none"> <li>• Aluminium composite panel 3 mm</li> </ul>	Rust	A3T 6Z RS	301	
	Canyon	A3T 6Z CY		
	Slate	A3T 6Z SC		
	Stone beige	A3T 6Z NB		
	Grey stone	A3T 6Z NG		
	Light stone colour	A3T 6Z NH		
	Stone Verdello	A3T 6Z NV		
	Oak	A3T 6Z EI		
	Light glossy marble	A3T 6Z ML	343	
	Grey glossy marble	A3T 6Z MG		
	Matterhorn glossy	A3T 6Z F1	547	
	Forest glossy	A3T 6Z F2		
	Beach glossy	A3T 6Z F3		
	 <p><b>Wall panel TREND</b> A = 2550 × B = 1500 mm</p> <ul style="list-style-type: none"> <li>• Aluminium composite panel 3 mm</li> </ul>	Rust	A3T HZ RS	473
Canyon		A3T HZ CY		
Slate		A3T HZ SC		
Stone beige		A3T HZ NB		
Grey stone		A3T HZ NG		
Light stone colour		A3T HZ NH		
Stone Verdello		A3T HZ NV		
Oak		A3T HZ EI		
Light glossy marble		A3T HZ ML	523	
Grey glossy marble		A3T HZ MG		
 <p><b>Surface adhesive</b> Suitable for use on tiles, concrete, plaster, plasterboard, gypsum fiber plate, wood and metal.</p>	1 x 600 ml	A30 01	39	
	3 x 600 ml for width 1000 mm	A30 02	89	
	4 x 600 ml for width 1250 mm	A30 03	109	
	5 x 600 ml for width 1500 mm	A30 04	129	

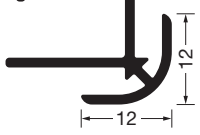
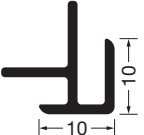

ARTWEGER price list 03/2023. For specialised trade outlets only. Suggested retail prices in EUR not including VAT.  
DIMENSIONS IN MILLIMETRES.

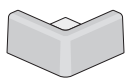
Connection profiles	Colour	Art. no.	Price in EUR
 <p><b>Connector profile</b> Connects two wall panels in straight alignment. Length 2550 mm.</p>	High-gloss metal Matt black	<b>A3P 1Z MH</b> <b>A3P 1Z SM</b>	51 85
 <p><b>End-piece profile</b> Necessary for covering the cut edges on the side. Length 2550 mm.</p>	High-gloss metal Matt black	<b>A3P 2Z MH</b> <b>A3P 2Z SM</b>	51 85
 <p><b>Inner corner profile</b> Connects two wall panels at an angle to each other. Length 2550 mm.</p>	High-gloss metal Matt black	<b>A3P 3Z MH</b> <b>A3P 3Z SM</b>	51 85
 <p><b>Outer corner profile rounded</b> Connects two wall panels at an angle to each other. Length 2550 mm.</p>	High-gloss metal Matt black	<b>A3P 4Z MH</b> <b>A3P 4Z SM</b>	51 85
 <p><b>Outer corner profile</b> Connects two wall panels at an angle to each other. Length 2550 mm.</p>	High-gloss metal Matt black	<b>A3P 6Z MH</b> <b>A3P 6Z SM</b>	51 85
 <p><b>End-piece profile</b> For flush covering of the lateral cut edges and of build pedestals and disposal surfaces. Length 2550 mm.</p>	High-gloss metal Matt black	<b>A3P 7Z MH</b> <b>A3P 7Z SM</b>	51 85
 <p><b>Corner connection fits A3P7Z (2 pieces)</b></p>	High-gloss metal Matt black	<b>A3P EV MH</b> <b>A3P EV SM</b>	22 37

ARTWALL 3.0  
Wall panels

## Installation without visible profiles - only TREND wall panel

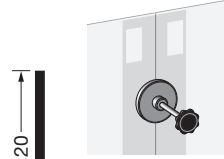
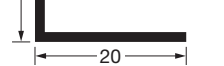
	Art. no.	Price in EUR
 <p><b>Panel joint profile 100 mm</b> Connects two wall panels in straight alignment. Galvanised steel. Length 3000 mm.</p>	<b>A3P PZ</b>	99
 <p><b>Magnetic stamp for A3P PZ</b> Mounting aid for flush pressing of the wall panels. Only in combination with connection profile A3P PZ. At a height of 2500 mm, 10 to 20 pieces are required per panel joint.</p>	<b>A30 11</b>	59
 <p><b>Angle profile 20 mm</b> Connects two wall panels at an angle to each other. Aluminium. Length 2550 mm.</p>	<b>A3P 9Z</b>	51

### Routing and folding technology for seamless corner joints.

Suitable panel cutters: Makita CA5000XJ, Mafell MF 26cc, Festool PF 1200.

Makita CA5000XJ, Mafell MF 26cc, Festool PF 1200.

Routing and folding technique is not possible with glossy surfaces.

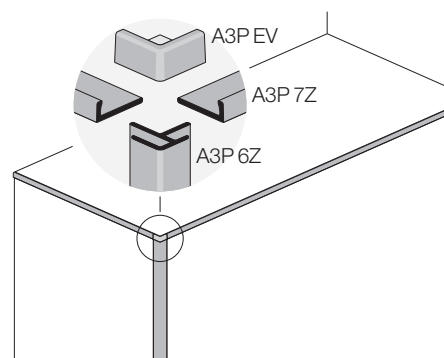
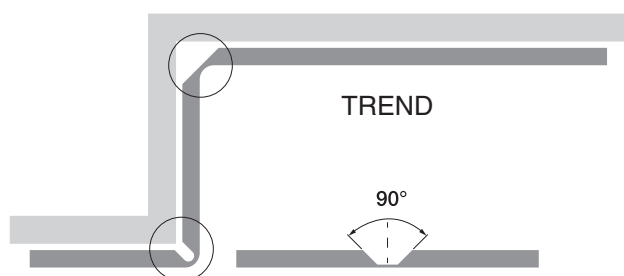

## IMPORTANT

- Appropriate tool required.

# Artweger ARTSTONE

Mineral cast shower trays

- Modern structured look in white and anthracite
- Massive, solid-coloured tub
- On site cutting and custom fitting possible
- Particularly stable and very flat (30 mm)
- Including anti-slip coating class B according to DIN 51097
- Polished stainless steel drain cover included

- **ARTSTONE cast stone tubs are not suitable for installation on underfloor heating systems due to temperature fluctuations or material expansion.**



**Artweger**



Massive, solid-coloured tub.  
Colors white and anthracite.



Only 30 mm high: Extra-flat shower trays for installation on existing floors.



A real eye-catcher in the bathroom and non-slip shower tray is the shower tray ARTSTONE with its slate-look finish. Due to its high strength, it can be made particularly flat and is suitable for floor-level installation. When mounted on an existing floor, it provides almost barrier-free access with only 30 mm of tub height.

## Suitable drain fittings

Not available from Artweger.

- Geberit d90: Austria: art. no. 150.550.00.1, Germany: art. no. 150.553.00.1., Switzerland: art. no. 150.556.00.1, Netherlands: art. no. 150.550.00.1, France/Belgium: art. no. 150.550.00.1, art. no. 150.551.21.1
- Dallmer ORIO DN 50: art. no. 160010
- HL DN 40/50: art. no. HL520F.0

## Installation sets:

- HL FlexBox: art. no. HL570.0 without cover
- Dallmer ORIO Dallbox DN 50: art. no. 161512

## Cutting to size

Possible at the edges of the wall.

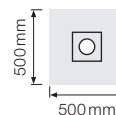
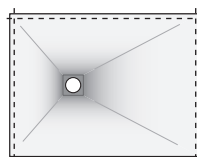

Non-cutting area.





- Any adjustment of dimensions can be made on site during installation. Appropriate tool required.
- The surface of the shower tray slopes towards the drain. After cutting, none of the edges will be absolutely horizontal.

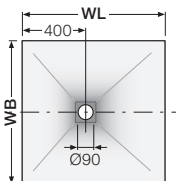
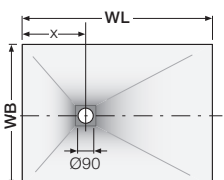
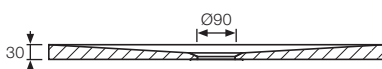

ARTWEGER price list 03/2023. For specialised trade outlets only. Suggested retail prices in EUR not including VAT.  
DIMENSIONS IN MILLIMETRES.

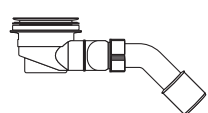
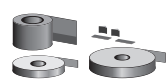
ARTSTONE		Length WL × width WB	Art. no. White slate	Art. no. Anthracite slate	Price in EUR	
		800 × 800 × 30	<b>WMA 01 WF</b>	<b>WMA 01 AF</b>	626	
		900 × 900 × 30	<b>WMA 02 WF</b>	<b>WMA 02 AF</b>	695	
		1000 × 1000 × 30	<b>WMA 03 WF</b>	<b>WMA 03 AF</b>	812	
For dimensions 900 × 900 and 1000 × 1000 the drain is not centered.						
 <p>WL up to 1600 mm: x = 400 mm WL over 1600 mm: x = 600 mm</p> 		900 × 800 × 30	<b>WME 12 WF</b>	<b>WME 12 AF</b>	668	
		1000 × 900 × 30	<b>B+S</b>	<b>WME 13 WF</b>	<b>WME 13 AF</b>	750
		1200 × 900 × 30	<b>B+S</b>	<b>WME 14 WF</b>	<b>WME 14 AF</b>	878
		1200 × 1000 × 30	<b>B+S</b>	<b>WME 19 WF</b>	<b>WME 19 AF</b>	994
		1400 × 900 × 30	<b>B+S</b>	<b>WME 15 WF</b>	<b>WME 15 AF</b>	994
		1400 × 1000 × 30		<b>WME 20 WF</b>	<b>WME 20 AF</b>	1,171
		1600 × 750 × 30		<b>WME 16 WF</b>	<b>WME 16 AF</b>	1,057
		1600 × 900 × 30		<b>WME 21 WF</b>	<b>WME 21 AF</b>	1,171
		1600 × 1000 × 30		<b>WME 23 WF</b>	<b>WME 23 AF</b>	1,308
		1700 × 750 × 30		<b>WME 17 WF</b>	<b>WME 17 AF</b>	1,103
		1800 × 800 × 30		<b>WME 18 WF</b>	<b>WME 18 AF</b>	1,171
		1800 × 900 × 30		<b>WME 22 WF</b>	<b>WME 22 AF</b>	1,316

## ACCESSORIES

		Art. no.	Price in EUR
	Surface adhesive 1 piece, capacity ca. 600 ml Two pieces required with 1400 × 900 mm and larger. 1 piece, capacity ca. 600 ml. Suitable for use on tiles, concrete, cement screeds and composite sealings.	<b>WM0 01</b>	48
	Drain set Ø 90 mm With sealing tape length 3600 mm.	<b>WM0 07</b>	161
	Sealing tape length 3600 mm For sealing and sound installation between the tub, the structure and the tiles. Including the tile tape.	<b>W0 12</b>	97
	Drain cover	White <b>WM0 05</b> Anthracite <b>WM0 06</b>	54 54
	Blitz Blank	1 litre <b>90 903</b> 6 × 1 litre <b>90 904</b>	20 114
	Repair set	White <b>WM0 03</b> Anthracite <b>WM0 04</b>	83 83

## IMPORTANT

- Due to the manufacturing technique deviations of measurements of + 10 / -0 are possible.
  - Due to the structured surface the water may not drain completely.
  - Drain set Ø 90 mm, Art. Nr. W001 not suitable for ARTSTONE.
- **B+S** = The size of the shower tray is suitable for use with the BODY+SOUL steam shower.

# SHOWER TRAYS | BATHTUBS Acrylic



**Artweger®**



Delivery available  
with additional freight costs.

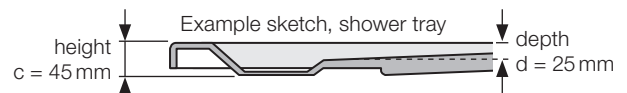
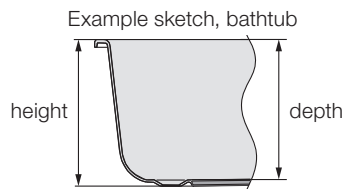

**Optional: ART-Grip - anti-slip zone** anti-slip coating class C according to DIN 51097.

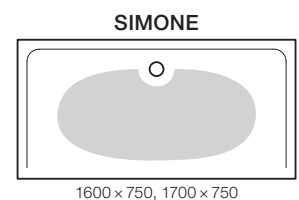
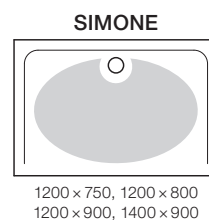
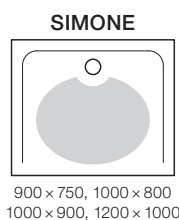
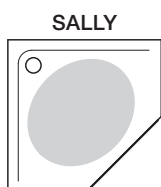
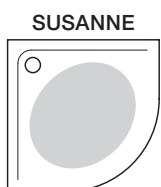



# SHOWER TRAYS Acrylic

ARTWEGER price list 03/2023. For specialised trade outlets only.  
Suggested retail prices in EUR not including VAT. DIMENSIONS IN MILLIMETRES.

Art. no.	Colour	Additional features
W		

Base price      Surcharge

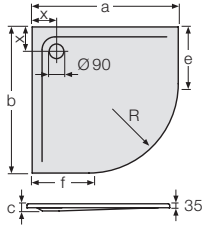
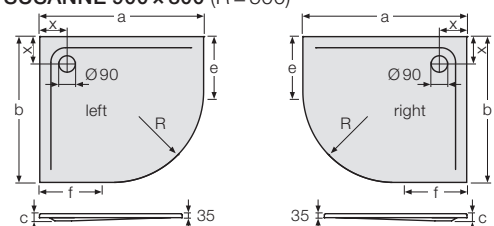
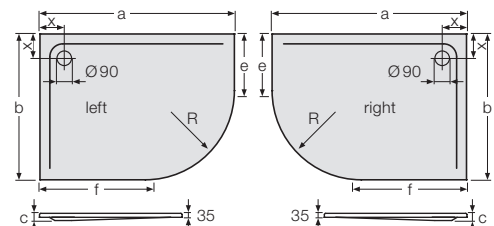
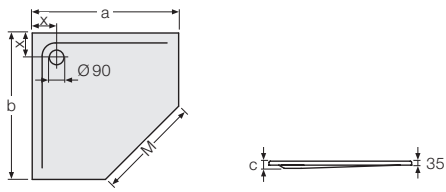
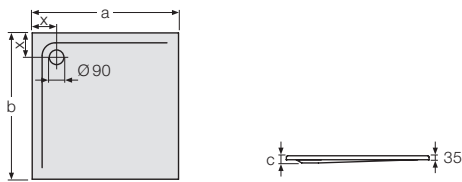
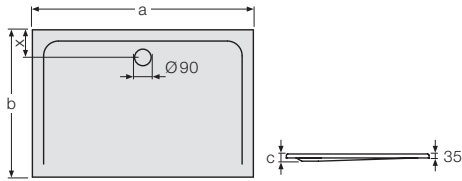
left	right	Length x Width	Height / Depth	Other dimensions			left	right	WS White	A ART-Grip (optional)
		<b>a x b</b>	<b>c/d</b>	<b>e</b>	<b>f</b>	<b>x</b>				
<b>SUSANNE</b> 		800: R=500 900: R=550 1000: R=550 1200: R=550	800 x 800 900 x 900 B+S 1000 x 1000 B+S 1200 x 1200 B+S	45/25 45/25 45/25 45/25	300 300 150 350 350 150 450 450 150 650 650 150	WR 22 WR 23 WR 24 WR 29	481 505 634 1,040	220		
<b>SUSANNE 900 x 800 (R=500)</b> 		900 x 800	45/25	300 400 150	WR 33	WR 32	624	220		
<b>SUSANNE 1200 x 900 (R=550)</b> 		1200 x 900 B+S	45/25	350 650 150	WR 31	WR 30	920	220		
<b>SALLY (M=636)</b> 		900 x 900 1000 x 1000	45/25 45/25	450 450 150 550 550 150	WF 07 WF 08	505 644	220			
<b>SABINE</b> 		800 x 800 900 x 900 B+S 1000 x 1000 B+S 1200 x 1200	45/25 45/25 45/25 45/25	- - 150 - - 150 - - 150 - - 150	WV 12 WV 13 WV 14 WV 27	445 463 561 843	220 257			
<b>SIMONE</b> 		900 x 750 1000 x 800 B+S 1000 x 900 B+S 1200 x 750 1200 x 800 B+S 1200 x 900 B+S 1200 x 1000 B+S 1400 x 900 B+S 1600 x 750 1700 x 750	45/25 45/25 45/25 45/25 45/25 45/25 45/25 45/25 45/25 45/25	- - 150 - - 150 - - 150 - - 150 - - 150 - - 150 - - 150 - - 150 - - 150 - - 150	WV 15 WV 25 WV 26 WV 16 WV 17 WV 18 WV 19 WV 20 WV 21 WV 22	463 596 625 625 625 736 816 905 984 1,011	220 257			

SHOWER TRAYS  
BATHTUBS

## IMPORTANT

- Suitable for 90 mm drain.
- B+S= The size of the shower tray is suitable for use with the BODY+SOUL steam shower.

SHOWER TRAYS Acrylic

**READY FOR DISPATCH WITHIN 3 DAYS**

ARTWEGER price list 03/2023. For specialised trade outlets only. Suggested retail prices in EUR not including VAT.  
DIMENSIONS IN MILLIMETRES.

SHOWER TRAYS Acrylic - colour white

Length **a** × width **b**

Art. no.

Price in EUR

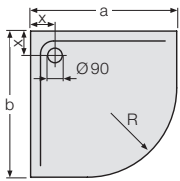

SUSANNE

800 × 800 R=500	<b>WR 22 WS</b>	481
900 × 900 R=550	<b>WR 23 WS</b>	505
1000 × 1000 R=550	<b>WR 24 WS</b>	634
1200 × 1200 R=550	<b>WR 29 WS</b>	1,040

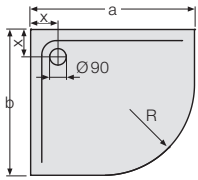

SUSANNE left

900 × 800 R=500	<b>WR 33 WS</b>	624
-----------------	-----------------	-----

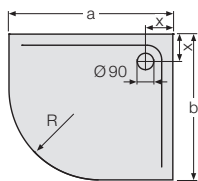

SUSANNE right

900 × 800 R=500	<b>WR 32 WS</b>	624
-----------------	-----------------	-----

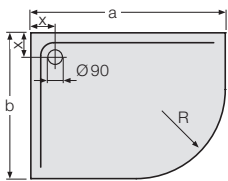

SUSANNE left

1200 × 900 R=550	<b>WR 31 WS</b>	920
------------------	-----------------	-----

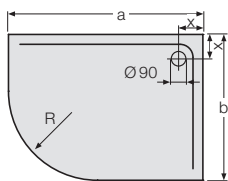

SUSANNE right

1200 × 900 R=550	<b>WR 30 WS</b>	920
------------------	-----------------	-----

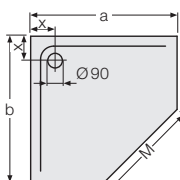

SALLY

900 × 900 M=636	<b>WF 07 WS</b>	505
1000 × 1000 M=636	<b>WF 08 WS</b>	644

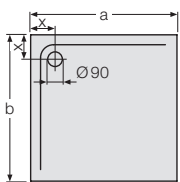

SABINE

800 × 800	<b>WV 12 WS</b>	445
900 × 900	<b>WV 13 WS</b>	463
1000 × 1000	<b>WV 14 WS</b>	561
1200 × 1200	<b>WV 27 WS</b>	843

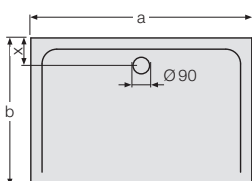

SIMONE

900 × 750	<b>WV 15 WS</b>	463
1000 × 800	<b>WV 25 WS</b>	596
1000 × 900	<b>WV 26 WS</b>	625
1200 × 750	<b>WV 16 WS</b>	625
1200 × 800	<b>WV 17 WS</b>	625
1200 × 900	<b>WV 18 WS</b>	736
1200 × 1000	<b>WV 19 WS</b>	816
1400 × 900	<b>WV 20 WS</b>	905
1600 × 750	<b>WV 21 WS</b>	984
1700 × 750	<b>WV 22 WS</b>	1,011

c = 45mm, x = 150mm

Accessories see page 229.

# Artweger ACCESSORIES

## PROMPT DELIVERY

ARTWEGER price list 03/2023. For specialised trade outlets only. Suggested retail prices in EUR not including VAT.  
DIMENSIONS IN MILLIMETRES.

### ACCESSORIES



#### Set of feet

For bathtubs.

Adjustable from 125 - 195 mm.

**WH 01**

50



For shower trays.

Adjustable from 87 - 115 mm.

**WH 02**

53



For shower trays.

Adjustable from 125 - 185 mm.

**WH 03**

53



For shower trays 1000 mm and wider.

Adjustable from 87 - 115 mm.

**WH 06**

95

#### Set of mounting brackets, length 670 mm

2 pieces

**WH 04**

44

3 pieces

**WH 05**

64



#### Sealing tape, length 3600 mm

**W0 12**

97

For sealing and sound installation between the tub, the structure and the tiles. Including the tile tape.

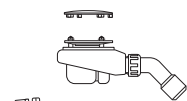

#### Drain set Ø 90 mm

For shower trays acrylic.

chrome

**W0 01 VC**

100

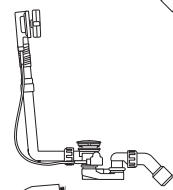

#### Drain set Ø 50 mm, length 540 mm

Without inlet

chrome

**W0 02 VC**

133

With integrated inlet

chrome

**W0 04 VC**

424



#### Drain set Ø 50 mm, length 720 mm

Without inlet

chrome

**W0 03 VC**

167

With integrated inlet

chrome

**W0 05 VC**

490

#### Blitz Blank

Environmentally friendly cleanser for bathtubs and showers.

1 litre

**90 903**

20

6 × 1 litre

**90 904**

114

# Artweger ACCESSORIES

ARTWEGER price list 03/2023. For specialised trade outlets only. Suggested retail prices in EUR not including VAT.  
DIMENSIONS IN MILLIMETRES.

### ACCESSORIES



#### Polishing set

Polishing cloth, polishing sponge, polishing paste, sandpaper.

**W0 11**

38

#### Repair set for acryl

white

**WH 11**

170

BATHTUBS Acrylic - colour white

Art. no.

Price in EUR

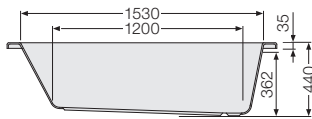
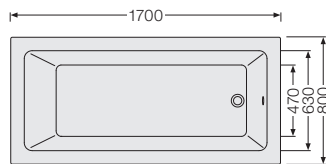

BARBARA 1700 × 800

W1 14 WS

917

Suitable for tub fitting set length 540 mm.  
Tub capacity ca. 170 litre.

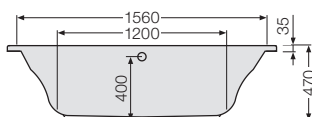
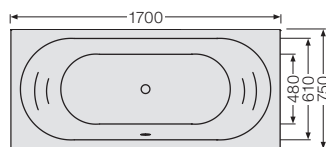

JULIA 1700 × 750

W1 13 WS

917

Suitable for tub fitting set length 720 mm.  
Tub capacity ca. 145 litre.

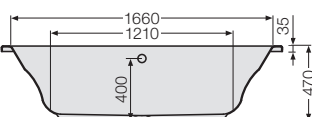
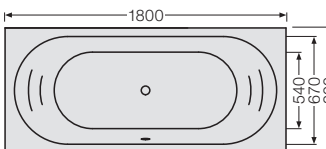

JULIA 1800 × 800

W1 04 WS

995

Suitable for tub fitting set length 720 mm.  
Tub capacity ca. 160 litre.

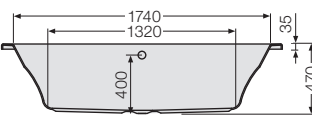
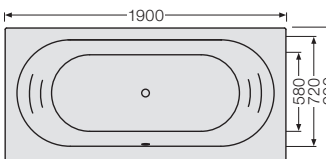

JULIA 1900 × 900

W1 05 WS

1,087

Suitable for tub fitting set length 720 mm.  
Tub capacity ca. 200 litre.

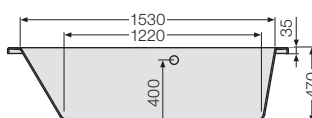
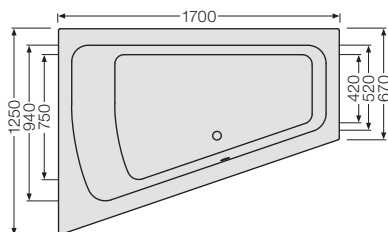

CORINNA 1700 × 1250  
left

W6 09 WS

1,249

Suitable for tub fitting set length 540 mm.  
Tub capacity ca. 210 litre.

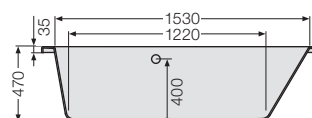
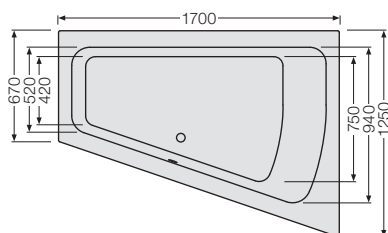

CORINNA 1700 × 1250  
right

W6 10 WS

1,249

Suitable for tub fitting set length 540 mm.  
Tub capacity ca. 210 litre.

Accessories see page 229.

Delivery available  
with additional freight costs.

**IMPORTANT**

• Suitable for drain. Ø50 mm.

BATHTUBS Acrylic - colour white

Art. no.

Price in EUR

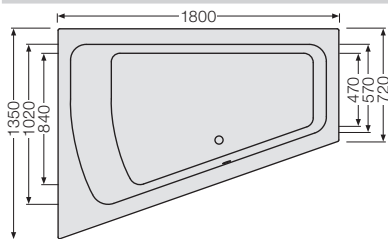

**CORINNA 1800 × 1350 left**

**W6 11 WS**

1,656

Suitable for tub fitting set length 540 mm.  
Tub capacity ca. 260 Liter.

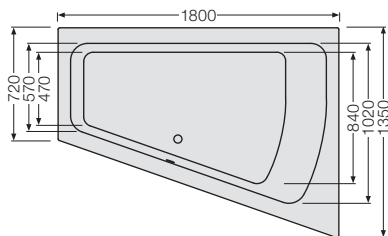

**CORINNA 1800 × 1350 right**

**W6 12 WS**

1,656

Suitable for tub fitting set length 540 mm.  
Tub capacity ca. 260 Liter.

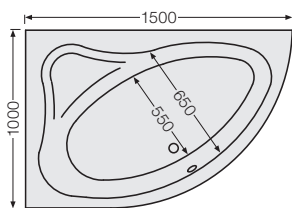

**SELINA 1500 × 1000 left**

**W6 07 WS**

1,126

Suitable for tub fitting set length 540 mm.  
Tub capacity ca. 150 litre.



**Skirt to SELINA left front panel**

**WB 03 WS**

703

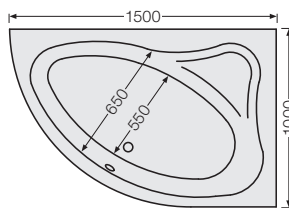

**SELINA 1500 × 1000 right**

**W6 08 WS**

1,126

Suitable for tub fitting set length 540 mm.  
Tub capacity ca. 150 litre.



**Skirt to SELINA right front panel**

**WB 04 WS**

703

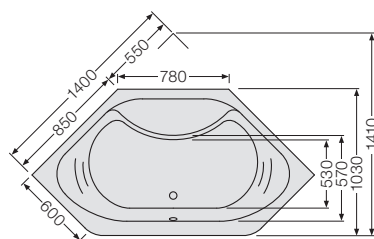

**VICTORIA 1400 × 1400**

**W2 01 WS**

1,384

Suitable for tub fitting set length 540 mm.  
Tub capacity ca. 170 litre.

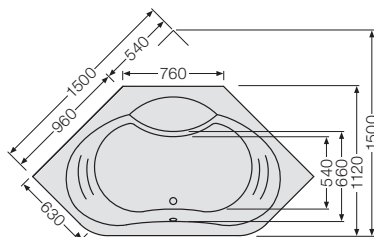

**ALEXANDRA 1500 × 1500**

**W2 03 WS**

1,384

Suitable for tub fitting set length 540 mm.  
Tub capacity ca. 170 litre.

Accessories see page 229.

Delivery available with additional freight costs.

**IMPORTANT**

- Tub capacity: Approximate average water consumption of a full bath with one person.

# FREEWAY

Free access to the bathtub

- Bathtub with door
- Easy one-handed operation of the integrated door (opens inwards)
- 6/8 mm single-pane safety glass
- Entry height 190 mm



Great comfort and safety are the main features of the FREEWAY bathtub.



Easy to use, simply lift the handle briefly to open the door. To close it just push the door until it snaps.



FREEWAY is a particularly comfortable bathtub, in which it is easy to relax. The inclined backrest with the optional headrest invites relaxation and well-being. With the other right end FREEWAY offers plenty of space even during long baths. An integrated door, opening inwards, allows to enter and exit safely.



A continuous seal, positioned on the inside, gives the FREEWAY bathtub a 100 % seal.

**Artweger**

**CE**

according to EN 12150  
and EN 14516



The optional non-slip coating makes the surface non-slip and provides secure support in the shower-tub. ARTGRIP is particularly durable and resistant.

# FREEWAY OVERVIEW OF PRODUCT FEATURES

ARTWEGER price list 03/2023. For specialised trade outlets only.

## Bathtub

- Plastic tub in white.
- Please order drain set extra.
- With pre-mounted assembly angles and tub feet. Including height-adjustable feet.
- With mechanical closure for installation without electricity.
- Tub capacity: Approximate average water consumption of a full bath with one person.

## Bathtub door

- Door opens to inside. Entrance width 535 mm. Handle with locking mechanism. Single-pane safety glass 8 mm.

## Tile substrate

- To allow for maintenance and service we recommend installing the FREEWAY tile backing board.
- Please order tile carrier separately.

# FREEWAY DIMENSIONS

ARTWEGER price list 03/2023. For specialised trade outlets only. DIMENSIONS IN MILLIMETRES.

## SHOWER AREA left

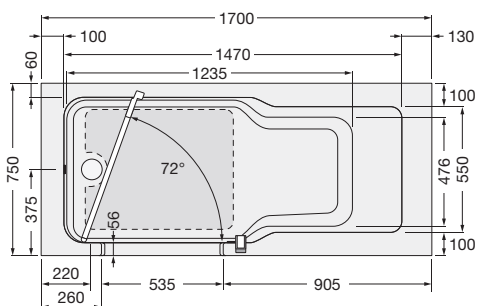
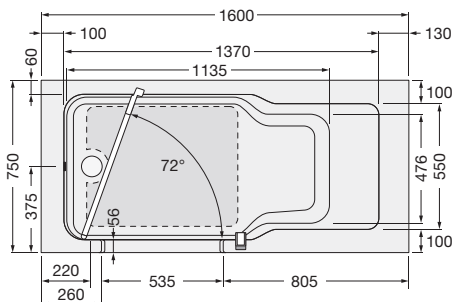
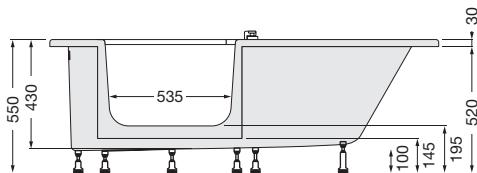

### FREEWAY 1600 x 750 depth 430

Tub capacity  
ca. 130 litres.

### FREEWAY 1700 x 750 depth 430

Tub capacity  
ca. 150 litres.

## SHOWER AREA right

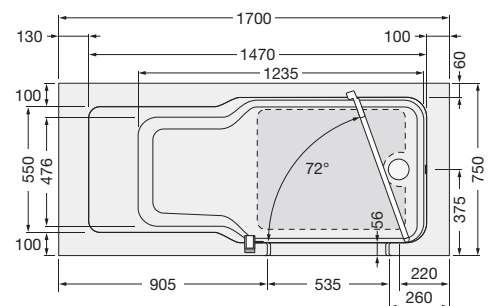
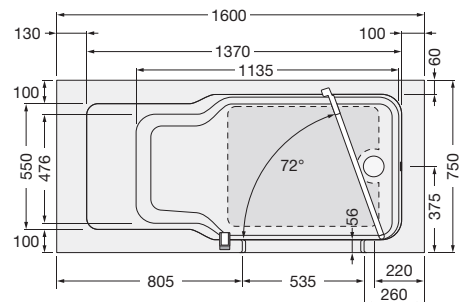
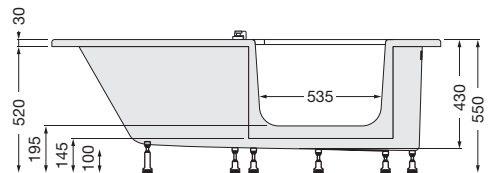

## ART-Grip Skid-resistant zone (scheme)









## IMPORTANT

- We will gladly send you the documents in hard copy on request.

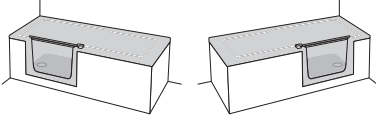
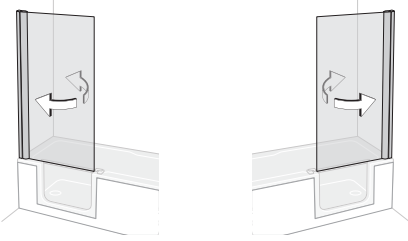
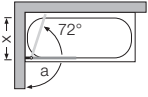
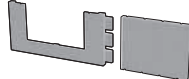
# FREEWAY BATHTUB WITH DOOR

Winged door 8 mm / Folding screen 6 mm ESG

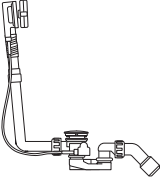
ARTWEGER price list 03/2023. For specialised trade outlets only. Suggested retail prices in EUR not including VAT.  
DIMENSIONS IN MILLIMETRES.

SHOWER AREA		Product description/ features		Length x width
left	right			
<b>Bathtub with door</b> 		<ul style="list-style-type: none"> <li>• With mechanical closure.</li> <li>• Please order drain set extra. - See below.</li> </ul>		1600 x 750 1700 x 750
<b>Single folding screen ARTLINE</b> 		Height  <b>1400</b>	Bathtub measurement (WM)  750	Width tub folding screen  814 - 832    a = 820 x = 760 
		<ul style="list-style-type: none"> <li>• Assembly on the left or right.</li> <li>• Please order bathtub extra.</li> <li>• Cannot be locked with bathtub door.</li> </ul>		
		Product description		
 <b>Tile substrate</b> front panel		<ul style="list-style-type: none"> <li>• <b>Assembly on the left or right.</b></li> <li>• Exact positioning on site.</li> <li>• Suitable for tiles with a thickness of at most 10 mm.</li> </ul>		
 <b>Tile substrate</b> side panel		<ul style="list-style-type: none"> <li>• <b>Required tile substrate</b></li> </ul>  <p> <b>alcove installation</b>                      <b>corner installation</b>                      <b>installation on straight wall</b>            1 x front panel                      1 x front panel and 1 x side panel                      1 x front panel and 2 x side panels         </p>		
 <b>Tub corner seat</b>		<ul style="list-style-type: none"> <li>• Height: 40 mm, width: 566 mm, depth: 290 mm</li> <li>• Capacity: 130 kg.</li> <li>• Can also be retrofitted to existing FREEWAY bathtubs.</li> <li>• Can be removed at any time and easy to clean.</li> </ul>		
 <b>Backrest</b>		<ul style="list-style-type: none"> <li>• Height: 360 mm, width: 300 mm, depth: 20 mm</li> <li>• Can also be retrofitted to existing FREEWAY bathtubs.</li> <li>• Can be removed at any time and easy to clean.</li> </ul>		
 <b>Drain set Ø 50 mm,</b> length 540 mm		<ul style="list-style-type: none"> <li>• Without inlet</li> </ul> <hr/> <ul style="list-style-type: none"> <li>• With integrated inlet</li> </ul>		
 <b>Sealing tape</b>		<ul style="list-style-type: none"> <li>• Length 3600 mm</li> <li>• For sealing and sound installation between the tub, the structure and the tiles. Including the tile tape.</li> </ul>		



Art. no.		Colour	Additional features
D F			
		Base price	Surcharge
BATHTUB DOOR		<b>WS</b> White	<b>A</b> ART-Grip (optional)
left	right	Tub in white, bathtub door high-gloss metal	
DFM1 03	DFM2 03	3,200	220
DFM1 01	DFM2 01		

Art. no.	Frame colour	Glazing
D F		
	Base price	Surcharge
	<b>MH</b> High-gloss metal	<b>EK</b> Glass clear
DFN0W1	581	0

Art. no.	Colour	
	Base price	
Art. no.	<b>AT</b> Anthracite	Colour not specified
DFF0 01	-	262
DFF0 11	-	136 per side
DF0B ES	309	-
DF0B RL	219	-
DF0B 02	-	129
DF0B 03	-	317
W0 12	-	97

# ARTSHOWER

The pure pleasure of showering

- Available in ROUND or SOFTEDGE versions
- 3 different hand showers
- Hand shower PLUS with SINGLE-shower-jet for cleaning the glasses of the shower enclosure and as a perfect complement to ARTCLEAR GLAS
- Overhead shower with Dropcontrol

## 2 DESIGNS



## OVERHEAD SHOWER WITH DROPCONTROL

No dripping after emptying the shower head, less limescale deposits

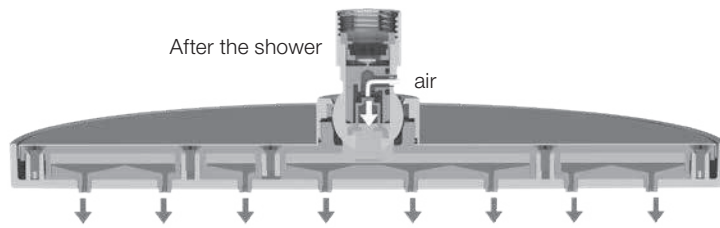

## SHOWER RAIL FLEX

with one fixed and one flexible fixing point - Ideal for the renovation



## HAND SHOWERS

PLUS and DUO with 2 types of shower sprays, STICK with wide-angle water jet. Hand shower PLUS with SINGLE-shower-jet supports the effect of ARTCLEAR GLASS ideally.



## THERMOSTATIC SHOWER MIXER

With temperature limiter and scalding protection.



# ARTSHOWER

ARTWEGER price list 03/2023. For specialised trade outlets only.  
Suggested retail prices in EUR not including VAT.

Art. no.

V A

Base price



## Counter display

The highlights from the range always at hand.

- 1 x ROUND - hand shower PLUS
- 1 x SOFTEDGE - hand shower PLUS
- 1 x SOFTEDGE - hand shower DUO

Art. no.

VAV1 01

246

# Artweger ARTSHOWER PROMPT DELIVERY

ARTWEGER price list 03/2023. For specialised trade outlets only. Suggested retail prices in EUR not including VAT.  
DIMENSIONS IN MILLIMETRES.

## ARTSHOWER Round - colour chrome

Art. no. Price in EUR

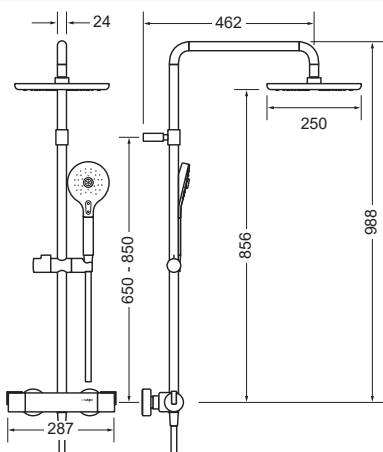

### Shower system 1

**VAR01 VC** 949

Thermostatic shower mixer, shower rail with one fixed and one flexible fixing point, swivelable and tiltable shower holder, overhead showerhead, hand shower PLUS, shower hose 1500 mm

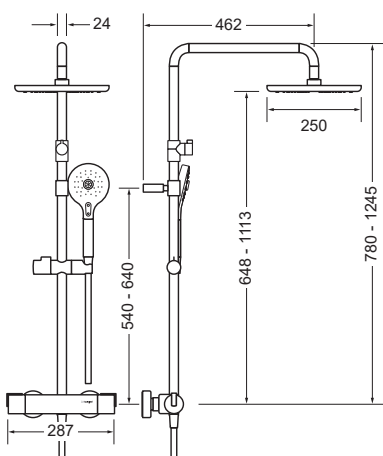

### Shower system 1 TELESKOP

**VAR04 VC** 999

Thermostatic shower mixer, shower rail with one fixed and one flexible fixing point, swivelable and tiltable shower holder, overhead showerhead, hand shower PLUS, shower hose 1500 mm

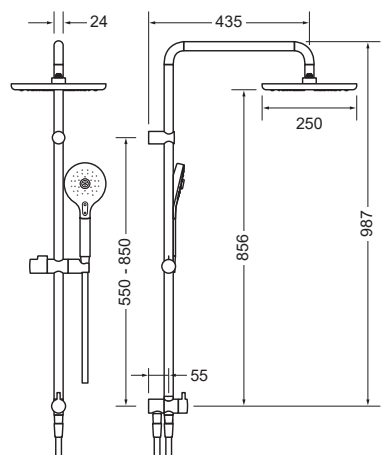

### Shower system 2

**VAR02 VC** 695

For connection to existing fitting, shower rail with one fixed and one flexible fixing point, swivelable and tiltable shower holder, 3-way diverter: overhead shower or hand shower, overhead shower and hand shower together, overhead showerhead, hand shower PLUS, shower hose 1500 mm and connection hose

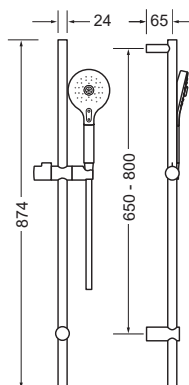

### Shower set

**VAR03 VC** 189

Shower rail with one fixed and one flexible fixing point, swivelable and tiltable shower holder, hand shower PLUS, shower hose 1500 mm

# Artweger ARTSHOWER PROMPT DELIVERY

ARTWEGER price list 03/2023. For specialised trade outlets only. Suggested retail prices in EUR not including VAT.  
DIMENSIONS IN MILLIMETRES.

## ARTSHOWER Round – colour chrome

Art. no. Price in EUR

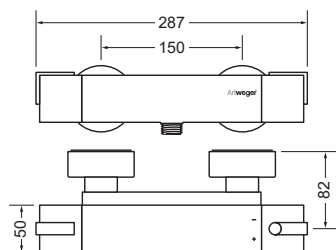

### Thermostatic shower mixer

**VAR 11 VC** 454

Regulated flow-rate 19l/min. at 3 bar pressure, suitable for instant water heaters, thermostatic shower mixer, DN 15 (G 1/2) with scalding protection at 38° C, thermostat body in brass, FEEL COOL safety housing, S-connections

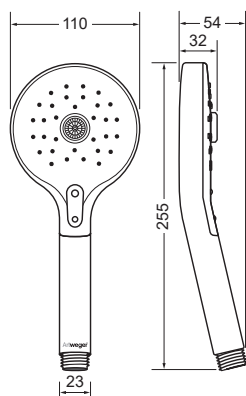

### Hand shower PLUS

**VAR 12 VC** 82

Ø 110 mm, 2 types of shower sprays RAIN / SINGLE, adjustable with push-button system, regulated flow-rate 12l/min. at 3 bar pressure, EASY-TO-CLEAN silicone nubs EASY-TO-CLEAN, HIGHLIGHT: SINGLE-shower-jet for cleaning the glasses of the shower enclosure

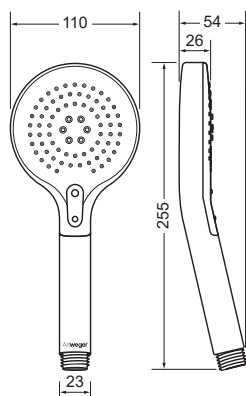

### Hand shower DUO

**VAR 13 VC** 65

Ø 110 mm, 2 types of shower sprays RAIN / MASSAGE, adjustable with push-button system, regulated flow-rate 12l/min. at 3 bar pressure, EASY-TO-CLEAN silicone nubs EASY-TO-CLEAN

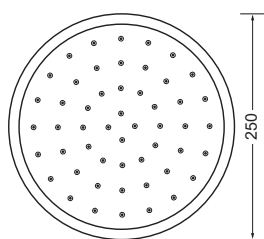

### Overhead showerhead DROPCONTROL

**VAR 14 VC** 249

Ø 250 mm, regulated flow-rate 16l/min. at 3 bar pressure, patented DROPCONTROL-Technology for emptying residual water after showering, swivelling, silicone nubs EASY-TO-CLEAN

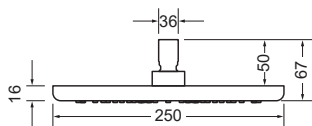

### Wall coupling

**VAR 15 VC** 42

Wall coupling for shower hose 1/2"

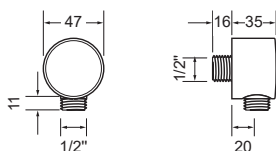

### Wall coupling with shower holder

**VAR 16 VC** 69

Wall coupling for shower hose 1/2" with fixture for hand showers with cone

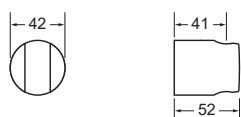
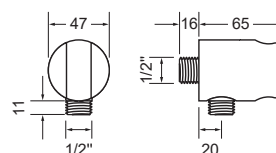

### Shower holder

**VAR 17 VC** 23

Fixture for hand showers with cone

# Artweger ARTSHOWER

## PROMPT DELIVERY

ARTWEGER price list 03/2023. For specialised trade outlets only. Suggested retail prices in EUR not including VAT.  
DIMENSIONS IN MILLIMETRES.

### ARTSHOWER Softedge – colour chrome

Art. no. Price in EUR

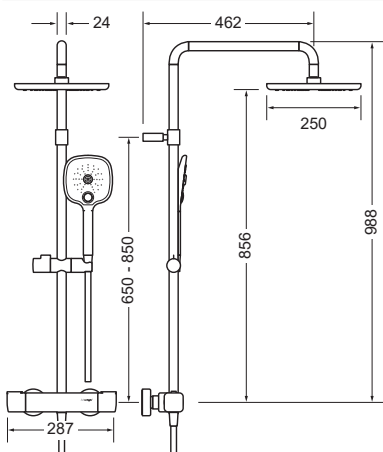

#### Shower system 1

Art. no. Price in EUR  
**VAS01 VC** 999

Thermostatic shower mixer, shower rail with one fixed and one flexible fixing point, swivelable and tiltable shower holder, overhead showerhead, hand shower PLUS, shower hose 1500 mm

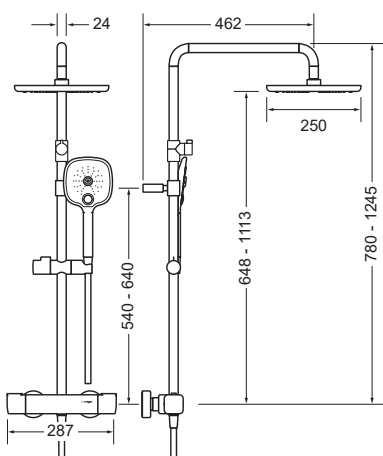

#### Shower system 1 TELESKOP

Art. no. Price in EUR  
**VAS04 VC** 1,049

Thermostatic shower mixer, shower rail with one fixed and one flexible fixing point, swivelable and tiltable shower holder, overhead showerhead, hand shower PLUS, shower hose 1500 mm

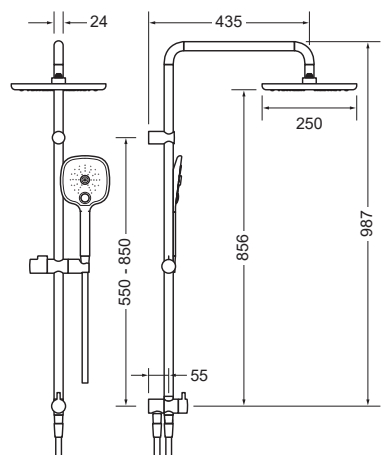

#### Shower system 2

Art. no. Price in EUR  
**VAS02 VC** 735

For connection to existing fitting, shower rail with one fixed and one flexible fixing point, swivelable and tiltable shower holder, 3-way diverter: overhead shower or hand shower, overhead shower and hand shower together, overhead showerhead, hand shower PLUS, shower hose 1500 mm and connection hose

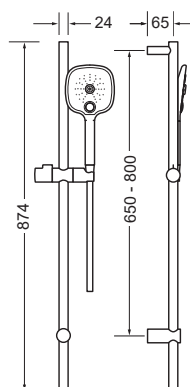

#### Shower set

Art. no. Price in EUR  
**VAS03 VC** 199

Shower rail with one fixed and one flexible fixing point, swivelable and tiltable shower holder, hand shower PLUS, shower hose 1500 mm

# Artweger ARTSHOWER PROMPT DELIVERY

ARTWEGER price list 03/2023. For specialised trade outlets only. Suggested retail prices in EUR not including VAT.  
DIMENSIONS IN MILLIMETRES.

## ARTSHOWER Softedge – colour chrome

Art. no. Price in EUR

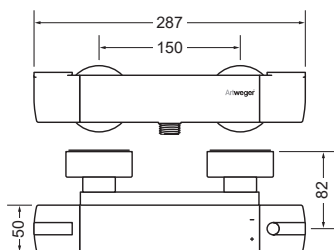

### Thermostatic shower mixer

**VAS 11 VC** 464

Regulated flow-rate 19l/min. at 3 bar pressure, suitable for instant water heaters, thermostatic shower mixer, DN 15 (G 1/2) with scalding protection at 38° C, thermostat body in brass, FEEL COOL safety housing, S-connections

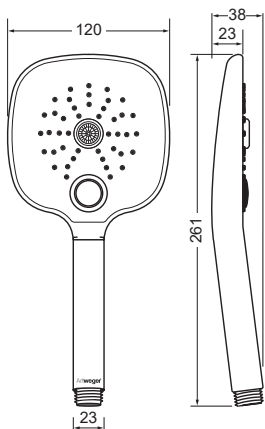

### Hand shower PLUS

**VAS 12 VC** 89

Width 120 mm, 2 types of shower sprays RAIN / SINGLE, adjustable with push-button system, regulated flow-rate 12l/min. at 3 bar pressure, silicone nubs EASY-TO-CLEAN, HIGHLIGHT: SINGLE-shower-jet for cleaning the glasses of the shower enclosure

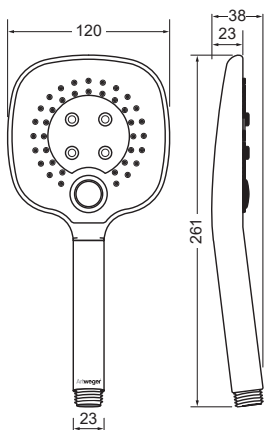

### Hand shower DUO

**VAS 13 VC** 75

Width 120 mm, 2 types of shower sprays RAIN / SPRAY, adjustable with push-button system, regulated flow-rate 12l/min. at 3 bar pressure, silicone nubs EASY-TO-CLEAN

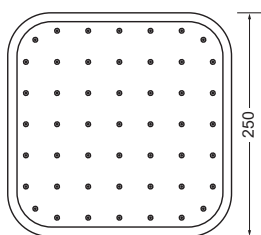

### Overhead showerhead DROPCONTROL

**VAS 14 VC** 288

250 x 250 mm, regulated flow-rate 16l/min. at 3 bar pressure, patented DROPCONTROL-Technology for emptying residual water after showering, swivelling, silicone nubs EASY-TO-CLEAN

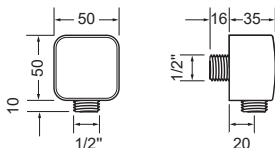
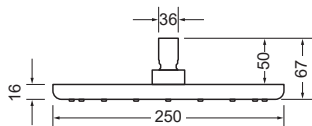

### Wall coupling

**VAS 15 VC** 44

Wall coupling for shower hose 1/2"

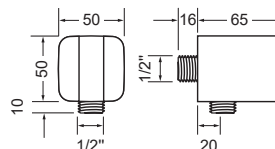

### Wall coupling with shower holder

**VAS 16 VC** 72

Wall coupling for shower hose 1/2" with fixture for hand showers with cone



### Shower holder

**VAS 17 VC** 24

Fixture for hand showers with cone

# Artweger ARTSHOWER PROMPT DELIVERY

ARTWEGER price list 03/2023. For specialised trade outlets only. Suggested retail prices in EUR not including VAT.  
DIMENSIONS IN MILLIMETRES.

## ARTSHOWER Uni – colour chrome

Art. no. Price in EUR

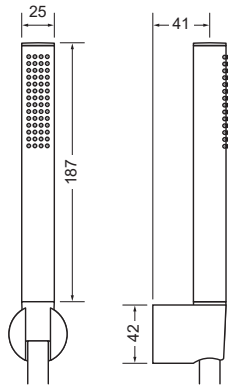

### Bathtub set STICK

Hand shower STICK, shower holder, shower hose 1250 mm

**VAU 01 VC**

105

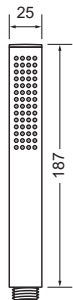

### Hand shower STICK

Stick  $\varnothing 25 \times 187$  mm, wide-angle water jet, regulated flow-rate 12 l/min. at 3 bar pressure, silicone nubs EASY-TO-CLEAN

**VAU 11 VC**

65



### Shower hose

Colour silver, reinforced plastic hose, 5-ply, connection swivel cone 1/2", tapered nut 1/2", tested according to DIN EN 1113

1250 mm	1 x	<b>VAU 12 VC</b>	18
1500 mm	1 x	<b>VAU 13 VC</b>	18
1750 mm	1 x	<b>VAU 14 VC</b>	19
1250 mm	10 x	<b>VAUS 12 VC</b>	165
1500 mm	10 x	<b>VAUS 13 VC</b>	165
1750 mm	10 x	<b>VAUS 14 VC</b>	174

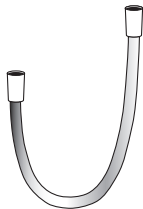

### Flexible connection hose

Colour silver, for shower system 2

750 mm 1 x **VAZ1 05** 15

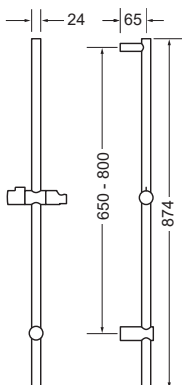

### Shower rail FLEX

One fixed and one flexible fixing point, swivelable and tiltable shower holder. Ideal for the renovation

**VAU 15 VC**

106



# Artweger ARTSHOWER

## PROMPT DELIVERY

ARTWEGER price list 03/2023. For specialised trade outlets only. Suggested retail prices in EUR not including VAT.  
DIMENSIONS IN MILLIMETRES.

ARTSHOWER Uni - colour chrome	Art. no.	Price in EUR
-------------------------------	----------	--------------

### Wall bar for overhead shower head

length 300 mm

**VAU 16 VC**

89

length 450 mm

**VAU 18 VC**

99

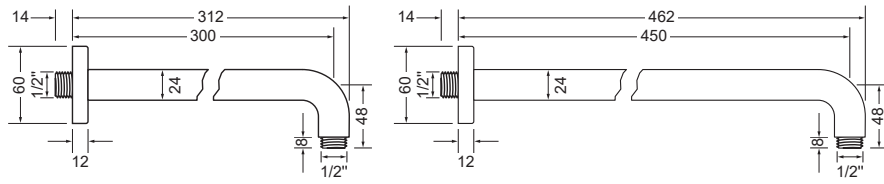







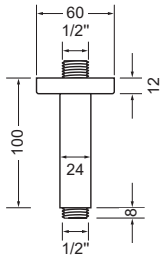

### Ceiling bar for overhead shower

length 100 mm

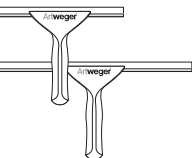
**VAU 17 VC**

67



ACCESSORIES		Art. no.	Price in EUR	
	<b>Blitz Blank</b>	1 litre	<b>90 903</b>	20
	Environmentally friendly cleanser for bathtubs and showers.	6 x 1 litre	<b>90 904</b>	114
	<b>Care set</b>	1 set	<b>0B 21</b>	59
	Consisting of: 1 litre BLITZ BLANK, 1 squeegee and 3 cleaning cloths.	4 x 1 set	<b>0B 24</b>	228
	<b>Care set for ARTCLEAR GLASS</b>		<b>0B 20</b>	82
	Consisting of: 1 litre BLITZ BLANK, 1 squeegee and 3 microfiber cleaning cloths. For ARTCLEAR and glazing without ARTCLEAN glass coating.			
	<b>Squeegee</b>	White	<b>0B 22</b>	25
	Width 240 mm	Chrome	<b>0B 23</b>	32
	<b>Squeegee XL</b>	White	<b>0B 27</b>	30
	Width 360 mm especially for Artweger Walk In.	Chrome	<b>0B 28</b>	38
	<b>Microfiber cleaning cloths</b>	3 pcs.	<b>0B 29</b>	18
	For ARTCLEAR and glazing without ARTCLEAN glass coating.	15 pcs.	<b>0B 30</b>	86
	<b>ARTCLEAN refreshing set</b>	1 set	<b>0B 31</b>	70
	For freshening up ARTWEGER shower screens delivered from works with an ARTCLEAN coating.			
	<b>Folding seat with backrest*</b>	Greyish silver/chrome	<b>0B KS</b>	593
	For installation on tiled walls. Soft seat. Overhang: 380 mm, folded up 85 mm. Ø300 mm. Carrying capacity 125 kg.			



**IMPORTANT**

\* For installation on tiled walls. A load-bearing wall must be available to mount the seat. For special types of walls such as aerated concrete the fixation materials have to be suitable ones recommended by the construction company. When installing wall heating please request drilling position sketch beforehand. Custom sizes not available.

**Notice to persons with pacemakers: In the seat back are magnets.**

# Artweger ACCESSORIES

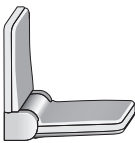
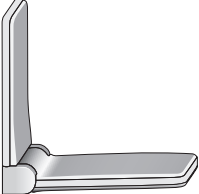
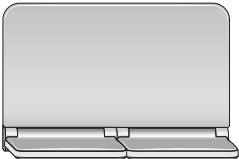
ARTWEGER price list 03/2023. For specialised trade outlets only. Suggested retail prices in EUR not including VAT.  
DIMENSIONS IN MILLIMETRES.

ACCESSORIES		Art. no.	Price in EUR
	<b>TWINLINE 2 Folding seat*</b> Folding mechanism with motion damper and magnetic catch. Height 320 mm, width 385 mm, depth 92 mm. Overhang: 335 mm. Capacity up to 130 kg.	Greyish silver/chrome <b>T20B KS</b>	957
	<b>BODY+SOUL Seat*</b> Folding mechanism with motion damper and magnetic catch. Height 500 mm, width 385 mm, depth 70/90 mm. Capacity up to 130 kg. Overhang: 510 mm.	Anthracite/silver Bordeaux/silver Sand/silver	<b>7SE0 11 AT</b> 1,120 <b>7SE0 11 BD</b> 1,120 <b>7SE0 11 SA</b> 1,120
	<b>BODY+SOUL Bench*</b> Folding mechanism with motion damper and magnetic catch. Height 500 mm, width 770 mm, depth 70/90 mm. Overhang: 510 mm. Capacity up to 130 kg. Can be used in spaces 1100 mm and wider.	Anthracite/silver Bordeaux/silver Sand/silver	<b>7SB0 21 AT</b> 2,400 <b>7SB0 21 BD</b> 2,400 <b>7SB0 21 SA</b> 2,400
	<b>Disinfecting agent liquid</b> For cleaning and disinfecting the Airpool system. Suitable for TWINLINE 1 AIR, TWINLINE 2 AIR and ARTLIFT AIR.	<b>TL0H D1</b>	77

**IMPORTANT**







# SPARE PARTS

ARTWEGER price list 03/2023. For specialised trade outlets only.  
Suggested retail prices in EUR not including VAT. DIMENSIONS IN MILLIMETRES.





Art. no.

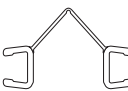

Base price

TWINLINE 1		Pieces			
	<b>Drain cover</b> Bathtub - Art. no.: TLM..., TLW..., TLA..., TLR..	1	Chrome	<b>TLZ1 01</b>	46
	<b>Hinge seal set, vertical</b> Shower door - Art. no.: TL81..., TL82..., TLS1..., TLS2..	1	-	<b>TLZ2 03</b>	40
	<b>Neck support</b> Bathtub - Art. no.: TLM..., TLW..., TLA..., TLR..	1	White	<b>TLZ1 12</b>	146
		1	Silver	<b>TLZ1 21</b>	177
	<b>Seat left</b> Bathtub - Art. no.: TLM..., TLW..., TLA..., TLR..	1	White	<b>TLZ1 25</b>	168
		1	Silver	<b>TLZ1 27</b>	209
	<b>Seat right</b> Bathtub - Art. no.: TLM..., TLW..., TLA..., TLR..	1	White	<b>TLZ1 24</b>	168
		1	Silver	<b>TLZ1 26</b>	209
	<b>Repair set, white</b> Bathtub TWINLINE 1	1	White	<b>TL0H 21</b>	172

TWINLINE 2		Pieces			
	<b>Drain cover</b> Bathtub - Art. no.: T2W1..., T2W2..., T2GW1..., T2GW2..	1	Chrome	<b>TLZ1 01</b>	46
	<b>Hinge seal set, vertical</b> Shower door - Art. no.: T281..., T282..., T2S1..., T2S2..	1	-	<b>T2Z2 01</b>	41
	<b>Bellows seal vertical</b> Shower screen - Art. no.: T2G81..., T2G82..., T2GS1..., T2GS2..	1	-	<b>T2Z2 05</b>	44
	<b>Drip moulding horizontal</b> Shower screen - Art. no.: T2G81..., T2G82..., T2GS1..., T2GS2..	1	-	<b>T2Z2 06</b>	44
	<b>Conversion set tub inlet</b> Bathtub left - Art. no.: T2W1.. Bathtub right - Art. no.: T2W2..	1	Chrome	<b>T20B 01</b>	161
		1	Chrome	<b>T20B 02</b>	161
	<b>Repair set, white</b> Bathtub TWINLINE 2	1	-	<b>T20B 04</b>	172

ARTLIFT		Pieces			
	<b>Drain cover</b> For all bathtubs.	1	Chrome	<b>ALZ1 19</b>	46
	<b>Hinge seal set, vertical</b> Shower door	1	-	<b>ALZ2 01</b>	41
	<b>Conversion set tub inlet</b> Bathtub left Bathtub right	1	Chrome	<b>AL0B 01</b>	161
		1	Chrome	<b>AL0B 02</b>	161
	<b>Backrest</b> Height: 360 mm Width: 300 mm Depth: 20 mm	1	Anthracite	<b>ALZ1 20</b>	217
	<b>Repair set, white</b> Bathtub ARTLIFT	1	-	<b>AL0B 04</b>	172

# SPARE PARTS

ARTWEGER price list 03/2023. For specialised trade outlets only.  
Suggested retail prices in EUR not including VAT. DIMENSIONS IN MILLIMETRES.

Art. no.



Base price

ARTWEGER 360		Pieces		
	<b>Magnetic seal, set 1</b> 1/4-round shower 1 door part, winged door in alcove, winged door next to shortened side screen, quadruple folding door, folding door U-form assembly - Art. no.: 9R3F., 9R4F., 9R5F., 9R8F., 9T3F., 9T4F., 9T5F., 9T8F., 9TDT0., 9TVP0..	2	<b>9Z201</b>	62
	<b>Magnetic seal, set 2</b> Winged door next to side screen, winged door for two side screens, double folding door next to side screen - Art. no.: 9R2F., 9RGF., 9T2F., 9TGF., 9T2T...	1 + 1	<b>9Z202</b>	62
	<b>Magnetic seal, set 7</b> Corner entry, swinging door with swinging side screen - Art. no.: 9RAP., 9RBP., 9REF0., 9REP0., 9TAP., 9TBP., 9TEF0., 9TEP0., 9TET0..	1 + 1	<b>9Z207</b>	62
	<b>Magnetic seal, set 8</b> Corner entry with folding doors without fixed parts - Art. no.: 9TETW..	1 + 1	<b>9Z226</b>	62
	<b>Magnetic seal, set 3</b> Pentagonal shower - Art. no.: 9R7F., 9T7F..	1 + 1	<b>9Z203</b>	62
	<b>Magnetic seal, set 9</b> Folding door solution for window 45° - Art. no.: 9TL1...	1 + 1	<b>9Z227</b>	62
	<b>Magnetic seal, set 4</b> Swinging door in alcove, swinging door next to shortened side screen, folding door in alcove - Art. no.: 9RTP., 9R5P., 9R9P., 9R4P., 9RDP0., 9R3P., 9T5P., 9T4P., 9TDP0., 9T3P., 9T5T..	1 + 1	<b>9Z204</b>	62
	<b>Magnetic seal, set 5</b> 1/4-round shower 2 door parts, swinging door 2 door parts, quadruple folding door, folding door U-form assembly - Art. no.: 9RRF0., 9RRP0., 9RDP0., 9TRF0., 9TRP0., 9TDP0., 9TDT0., 9TVP0., 9TL2..	2	<b>9Z205</b>	62
	<b>Magnetic seal, set 10</b> Folding door solution for window 90° - Art. no.: 9TL2...	1 + 1	<b>9Z228</b>	62
	<b>Magnetic seal, set 6</b> Swinging door next to side screen, swinging door for two side screens - Art. no.: 9R2P1., 9R2P2., 9RGP1., 9RGP2., 9T2P1., 9T2P2., 9TGP1., 9TGP2..	1 + 1	<b>9Z206</b>	62
	<b>fixed-part seal, set 1 vertical</b> All winged doors (without corner entry and pentagonal shower)	1	<b>9Z208</b>	47
	<b>fixed-part seal, set 2 vertical</b> Corner entry with winged doors, 1/4-round shower 2 winged doors - Art. no.: 9REF0., 9TEF0., 9TRF0., 9TRF1., 9TRF2., 9RRF0., 9RRF1., 9RRF2..	2	<b>9Z209</b>	54
	<b>fixed-part seal, set 3 vertical</b> Pentagonal shower - Art. no.: 9R7F., 9T7F..	1	<b>9Z210</b>	47
	<b>Bellows seal set 5 vertical</b> All swinging doors attached on fixed part	2 × 1, 2 × 2	<b>9Z215</b>	77
	<b>Bellows seal set 6 vertical</b> All swinging doors without fixed part, swinging side element .	6 × 1	<b>9Z216</b>	73
	<b>Bellows seal set 7 vertical</b> ARTWEGER 360 Walk In VARIO left - Art. no.: 9WV1., 9WV3., 9WV5., 9WTV1., 9WTV3., 9WTV5..	6 × 1	<b>9Z217</b>	73
	<b>Bellows seal set 8 vertical</b> ARTWEGER 360 Walk In VARIO right - Art. no.: 9WV2., 9WV4., 9WV6., 9WTV2., 9WTV4., 9WTV6..	6 × 1	<b>9Z218</b>	73
	<b>Bellows seal set 9 vertical</b> Folding door in alcove, 1/2 × corner entry with folding doors - Art. no.: 9T5T., 1/2 × 9TET0	3 × 1, 4 × 1 2 × 2, 1 × 1	<b>9Z219</b>	116
	<b>Bellows seal set 10 vertical</b> 1/2 × Folding door U-form assembly (left folding door) - Art. no.: 9TVP0..	1 + 1 + 2 + 2	<b>9Z220</b>	89
	<b>Bellows seal set 11 vertical</b> 1/2 × Folding door U-form assembly (right folding door) - Art. no.: 9TVP0..	1 + 1 + 2 + 2	<b>9Z221</b>	89
	<b>Bellows seal set 15 vertical</b> 1/2 × Corner entry with folding doors - Art. no.: 9TETW..	1 + 1 + 2 + 2	<b>9Z229</b>	102
	<b>Sealing strip, set vertical</b> 1/2 × Corner entry with folding doors, folding door solution for window - Art. no.: 9TETW., 9TL1., 9TL2..	2	<b>9Z225</b>	50

# SPARE PARTS

ARTWEGER price list 03/2023. For specialised trade outlets only.  
Suggested retail prices in EUR not including VAT. DIMENSIONS IN MILLIMETRES.

Art. no.

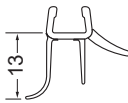
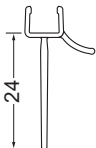
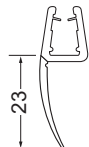

Base price

ARTWEGER 360		Pieces		
	<b>Drip mouldings, set 1 horizontal</b> 1/4-round shower 1 door part, winged door in alcove, winged door next to side screen, pentagonal shower, pivoting splashguard, swinging door with swinging side screen - Art. no.: 9R2F.., 9R2P.., 9R3F.., 9R3P.., 9R4F.., 9R4P.., 9R5F.., 9R5P.., 9R7F.., 9R8F.., 9R9P.., 9RAP.., 9RBP.., 9RDP.., 9RGF.., 9RGP.., 9RTP.., 9T2F.., 9T2P.., 9T3F.., 9T3P.., 9T4F.., 9T4P.., 9T5F.., 9T5P.., 9T7F.., 9T8F.., 9TAP.., 9TBP.., 9TDP.., 9TGF.., 9TGP.., 9WLO..	1	<b>9Z5 01</b>	34
	<b>Drip mouldings, set 3 horizontal</b> 1/4-round shower 2 door parts, corner entry - Art. no.: 9RRF.., 9RRP.., 9TRF.., 9TRP.., 9REF.., 9REP.., 9TEF.., 9TEP..	2	<b>9Z5 03</b>	54
	<b>Drip mouldings, set 7 horizontal</b> Double folding door - Art. no.: 9T5T.., 9TWT.., 9T2T..	2	<b>9Z5 07</b>	54
	<b>Drip mouldings, set 9 horizontal</b> Quadruple folding door, corner entry with folding doors - Art. no.: 9TDT0.., 9TET0..	4	<b>9Z5 09</b>	62
	<b>Drip moulding 24 mm 1 horizontal</b> 1/4-round shower 1 door part, winged door in alcove, winged door next to side screen, pentagonal shower, swinging door with swinging side screen, ARTWEGER 360 Walk In VARIO - Art. no.: 9R2F.., 9R2P.., 9R3F.., 9R3P.., 9R4F.., 9R4P.., 9R5F.., 9R5P.., 9R7F.., 9R8F.., 9R9P.., 9RAP.., 9RBP.., 9RDP.., 9RGF.., 9RGP.., 9RTP.., 9T2F.., 9T2P.., 9T3F.., 9T3P.., 9T4F.., 9T4P.., 9T5F.., 9T5P.., 9T7F.., 9T8F.., 9TDP.., 9TGF.., 9TGP.., 9TAP.., 9TBP.., 9WTV1.., 9WTV2.., 9WTV3.., 9WTV4.., 9WTV5.., 9WTV6.., 9WV1.., 9WV2.., 9WV3.., 9WV4.., 9WV5.., 9WV6..	1	<b>9Z5 22</b>	34
	<b>Drip moulding 24 mm 2 horizontal</b> 1/4-round shower 2 door parts, corner entry, swinging door with swinging side screen, double folding door - Art. no.: 9RRF.., 9RRP.., 9TRF.., 9TRP.., 9REF.., 9REP.., 9RAP.., 9RBP.., 9TEF.., 9TEP.., 9TAP.., 9TBP.., 9T5T1.., 9T5T2.., 9TWT1.., 9TWT2.., 9T2T1.., 9T5T2..	2	<b>9Z5 23</b>	54
	<b>Drip moulding 24 mm 4 horizontal</b> Corner entry with folding doors - Art. no.: 9TETW.., 9TDT0.., 9TET0..	4	<b>9Z5 24</b>	62
	<b>Drip mouldings, set 6 horizontal</b> Folding door U-form assembly - Art. no.: 9TVP0...	2	<b>9Z5 06</b>	100
	<b>Drip mouldings, set 11 horizontal</b> Folding door solution for window 45° left - Art. no.: 9TL11..	1+1	<b>9Z5 11</b>	71
	<b>Drip mouldings, set 12 horizontal</b> Folding door solution for window 45° right - Art. no.: 9TL11..	1+1	<b>9Z5 12</b>	71
	<b>Drip mouldings, set 13 horizontal</b> Folding door solution for window 90° left - Art. no.: 9TL21..	1+1	<b>9Z5 13</b>	76
	<b>Drip mouldings, set 14 horizontal</b> Folding door solution for window 90° right - Art. no.: 9TL22..	1+1	<b>9Z5 14</b>	76

## IMPORTANT

- All prices subject to shipping charge.
- Further individual parts on request.
- When ordering mouldings and seals please specify length. Information on the existing Artweger product is required.











# SPARE PARTS





ARTWEGER price list 03/2023. For specialised trade outlets only.  
Suggested retail prices in EUR not including VAT. DIMENSIONS IN MILLIMETRES.

Art. no.

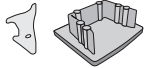
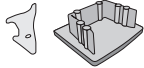

Base price

ARTWEGER 360 SLIDING DOOR		Pieces		
	<b>Magnetic seal, set 1</b> Quadruple sliding door - Art. no.: 9GDS0..	2	<b>9Z7 01</b>	62
	<b>Magnetic seal, set 2</b> Double sliding door next to side screen - Art. no.: 9G2S..	1 + 1	<b>9Z7 02</b>	62
	<b>Magnetic seal, set 3</b> Corner entry - Art. no.: 9GES0.., 9GESH..	1 + 1	<b>9Z7 12</b>	62
	<b>fixed-part seal, set 1 vertical</b> Double sliding door - Art. no.: 9G2S.., 9G5S..	2	<b>9Z7 03</b>	65
	<b>fixed-part seal, set 2 vertical</b> Quadruple sliding door, corner entry - Art. no.: 9GDS0.., 9GES0.., 9GESH..	4	<b>9Z7 04</b>	110
	<b>Drip mouldings, set 1 left</b> Double sliding door in alcove - Art. no.: 9G5S..	1 + 1	<b>9Z7 05</b>	53
	<b>Drip mouldings, set 2 right</b> Double sliding door in alcove - Art. no.: 9G5S..	1 + 1	<b>9Z7 06</b>	53
	<b>Drip mouldings, set 3 left</b> Double sliding door next to side screen - Art. no.: 9G2S..	1 + 1	<b>9Z7 07</b>	53
	<b>Drip mouldings, set 4 right</b> Double sliding door next to side screen - Art. no.: 9G2S..	1 + 1	<b>9Z7 08</b>	53
	<b>Drip mouldings, set 5 horizontal</b> Quadruple sliding door - Art. no.: 9GDS0..	2 × 2	<b>9Z7 09</b>	64
	<b>Drip mouldings, set 6 horizontal</b> Corner entry - Art. no.: 9GES0.., 9GESH..	4 × 1	<b>9Z7 10</b>	67

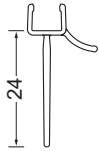
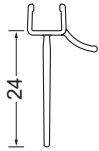
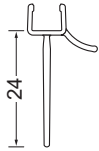
Artweger ZERO Walk In		Pieces		
	<b>Sealing strip, set</b> Wall profile, floor profile - Art. no.: RWV1.., RWV2.., RW11.., RW12..	1	<b>RWZ2 01</b>	57
	BASIC Wall profile - Art. no.: RWB.., RWC..	1	<b>RWZ2 02</b>	53
	<b>Bellows seal set 2 left vertical</b> VARIO without floor profile - Art. no.: RWV1.., RWC1..	6 × 1	<b>RWZ2 04</b>	75
	<b>Bellows seal set 3 right vertical</b> VARIO without floor profile - Art. no.: RWV2.., RWC2..	6 × 1	<b>RWZ2 05</b>	75
	<b>Bellows seal set 5 left vertical</b> VARIO without floor profile - Art. no.: RWV1.., RWC1..	6 × 1	<b>RWZ2 07</b>	75
	<b>Bellows seal set 6 right vertical</b> VARIO without floor profile - Art. no.: RWV2.., RWC2..	6 × 1	<b>RWZ2 08</b>	75
	<b>Drip mouldings, set 1 horizontal</b> VARIO without floor profile - Art. no.: RWV1.., RWV2.., RWC1.., RWC2..	1	<b>RWZ5 01</b>	34
	<b>Drip mouldings, set 3 left horizontal</b> VARIO without floor profile - Art. no.: RWV1.., RWC1..	1	<b>RWZ5 03</b>	34
	<b>Drip mouldings, set 4 right horizontal</b> VARIO without floor profile - Art. no.: RWV2.., RWC2..	1	<b>RWZ5 04</b>	34

## IMPORTANT

- A clear product identification is given by means of Artweger guarantee number (see guarantee certificate or sticker on the product) or article number (including all codes). Alternatively an indication of the Artweger delivery note number or invoice number is possible. If no clear product identification is given when ordering, mouldings, seals and rails must be adapted on site. Costs of adjustment and installation work are not accepted by Artweger.







# SPARE PARTS

ARTWEGER price list 03/2023. For specialised trade outlets only.  
Suggested retail prices in EUR not including VAT. DIMENSIONS IN MILLIMETRES.

Art. no.

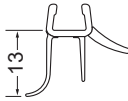
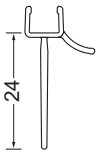

Base price

TWISTLINE		Pieces	Art. no.	Base price
	<b>Magnetic seal, set 1</b> 1/4-round shower, swinging door in alcove, swinging door next to shortened side screen, double swinging door next to side screen, double swinging door next to shortened side screen, folding door in alcove, folding door next to shortened side screen - Art. no.: 5TR..., 5W4..., 5W5..., 5WD..., 5T4..., 5T5..., 5TD..., 5W3..., 5T3..., 5WS..., 5WT..., 5F3..., 5F5..	2	<b>5TZ201</b>	62
	<b>Magnetic seal, set 2</b> Swinging door with swinging side screen, corner entry, corner entry with folding doors - Art. no.: 5TA..., 5TB..., 5WE..., 5TE..., 5FE..	2	<b>5TZ202</b>	62
	<b>Magnetic seal, set 3</b> Swinging door next to side screen, folding door next to side screen - Art. no.: 5W2..., 5T2..., 5F2..	2	<b>5TZ203</b>	62
	<b>Sealing strip, set 1</b> Products with 1 swinging door - Art. no.: 5W4..., 5W5..., 5T4..., 5T5..., 5W2..., 5T2..., 5W3..., 5T3..	2	<b>5TZ204</b>	50
	<b>Sealing strip, set 2</b> Products with 2 swinging doors - Art. no.: 5TR..., 5WD..., 5TD..., 5TA..., 5TB..., 5WE..., 5TE..., 5WS..., 5WT..	4	<b>5TZ213</b>	55
	<b>Drip mouldings, set 1 horizontal</b> Swinging door in alcove, swinging door next to side screen, swinging door next to shortened side screen, swinging door with swinging side screen - Art. no.: 5W4..., 5W5..., 5T4..., 5T5..., 5W2..., 5T2..., 5W3..., 5T3..., 5TA..., 5TB..	1	<b>5TZ205</b>	34
	<b>Drip mouldings, set 3 horizontal</b> 1/4-round shower, swinging door in alcove, corner entry, double swinging door next to side screen, double swinging door next to shortened side screen - Art. no.: 5TR..., 5WD..., 5TD..., 5WE..., 5TE..., 5WS..., 5WT..	2	<b>5TZ207</b>	54
	<b>Drip mouldings, set 2 horizontal</b> Swinging door in alcove, swinging door next to side screen, swinging door next to shortened side screen, swinging door with swinging side screen - Art. no.: 5W4..., 5W5..., 5T4..., 5T5..., 5W2..., 5T2..., 5W3..., 5T3..., 5TA..., 5TB..	1	<b>5TZ206</b>	34
	<b>Drip mouldings, set 4 horizontal</b> 1/4-round shower, swinging door in alcove, corner entry, double swinging door next to side screen, double swinging door next to shortened side screen, folding door, 1/2 x corner entry with folding doors - Art. no.: 5TR..., 5WD..., 5TD..., 5WE..., 5TE..., 5WS..., 5WT..., 5F21..., 5F22..., 5F31..., 5F32..., 5F51..., 5F52..., 5FE0..	2	<b>5TZ208</b>	54
	<b>Sealing strip</b> Double folding door - Art. no.: 5F2..., 5F3..., 5F5...	1	<b>5TZ209</b>	47
	Corner entry with folding doors - Art. no.: 5FE0..	2	<b>5TZ210</b>	54

## IMPORTANT

- All prices subject to shipping charge.
- Further individual parts on request.
- When ordering mouldings and seals please specify length. Information on the existing Artweger product is required.





# SPARE PARTS

ARTWEGER price list 03/2023. For specialised trade outlets only.  
Suggested retail prices in EUR not including VAT. DIMENSIONS IN MILLIMETRES.

Art. no.

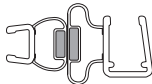
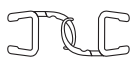
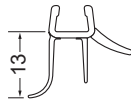

Base price

Artweger DYNAMIC		Pieces		
	<b>Magnetic seal, set</b> Corner entry - Art. no.: 6E0..	1+1	<b>6Z2 01</b>	62
	<b>Magnetic seal, set</b> 1/4-round shower - Art. no.: 6R0..	2	<b>6Z2 02</b>	62
	Swinging door in alcove - Art. no.: 641.., 642.., 651.., 652..	2	<b>6Z2 03</b>	62
	<b>Magnetic seal, set</b> Double swinging door next to side screen - Art. no.: 621.., 622..	1+1	<b>6Z2 04</b>	62
	<b>fixed-part seal, set</b> 1/4-round shower, corner entry - Art. no.: 6R0.., 6E0..	1+1+2+2	<b>6Z2 05</b>	62
	Swinging door in alcove - Art. no.: 641.., 642.., 651.., 652..	2+2+2	<b>6Z2 06</b>	50
	Double swinging door next to side screen - Art. no.: 621.., 622..	2+2+2	<b>6Z2 07</b>	50
	<b>Drip mouldings, set horizontal</b> 1/4-round shower radius I 500 - Art. no.: 6R0 49, 6R0 19, 6R0 89	2+2	<b>6Z5 01</b>	54
	1/4-round shower radius II 550 - Art. no.: 6R0 29, 6R0 69, 6R0 89	2+2	<b>6Z5 02</b>	54
	Corner entry 800 x 800 - Art. no.: 6E0 49	2+2	<b>6Z5 03</b>	54
	Corner entry 900 x 900, 1000 x 1000 - Art. no.: 6E0 59, 6E0 69	2+2	<b>6Z5 04</b>	54
	Corner entry 900 left x 750 right, 900 left x 800 right - Art. no.: 6E0 D9, 6E0 99	2+2	<b>6Z5 05</b>	54
	Corner entry 750 left x 800 right, 750 left x 900 right - Art. no.: 6E0 C9, 6E0 89	2+2	<b>6Z5 06</b>	54
	Swinging door in alcove with 1 fixed part 800 left, swinging door in alcove with 2 fixed parts 1000 left - Art. no.: 651 49, 641 69	1+1	<b>6Z5 07</b>	48
	Swinging door in alcove with 1 fixed part 800 right, swinging door in alcove with 2 fixed parts 1000 right - Art. no.: 652 49, 642 69	1+1	<b>6Z5 08</b>	48
	Swinging door in alcove with 1 fixed part left, swinging door in alcove with 2 fixed parts left, swinging door next to side screen left - Art. no.: 651 59, 651 69, 651 B9, 651 89, 641 B9, 641 89	1+1	<b>6Z5 09</b>	48
	Swinging door in alcove with 1 fixed part right, swinging door in alcove with 2 fixed parts right, swinging door next to side screen right - Art. no.: 652 59, 652 69, 652 B9, 652 89, 642 B9, 642 89	1+1	<b>6Z5 10</b>	48
	Swinging door in alcove with 2 fixed parts 900 left, swinging door next to side screen 800 left - Art. no.: 641 59, 621 49	1+1	<b>6Z5 11</b>	48
	Swinging door in alcove with 2 fixed parts 900 right, swinging door next to side screen 800 right - Art. no.: 642 59, 622 49	1+1	<b>6Z5 12</b>	48
	Swinging door next to side screen 900 left - Art. no.: 621 59	1+1	<b>6Z5 13</b>	48
	Swinging door next to side screen 900 right - Art. no.: 622 59	1+1	<b>6Z5 14</b>	48
	Corner entry 1200 x 1200 - Art. no.: 6E0 89	2+2	<b>6Z5 15</b>	54
	Corner entry 1200 left x 750 right, 1200 left x 800 right - Art. no.: 6E0 89	2+2	<b>6Z5 16</b>	54
	Corner entry 750 left x 1200 right, 800 left x 1200 right - Art. no.: 6E0 89	2+2	<b>6Z5 17</b>	54
	Corner entry 1200 left x 900 right, 1200 left x 1000 right - Art. no.: 6E0 89	2+2	<b>6Z5 18</b>	54
	Corner entry 900 left x 1200 right, 1000 left x 1200 right - Art. no.: 6E0 89	2+2	<b>6Z5 19</b>	54

## IMPORTANT

- A clear product identification is given by means of Artweger guarantee number (see guarantee certificate or sticker on the product) or article number (including all codes). Alternatively an indication of the Artweger delivery note number or invoice number is possible. If no clear product identification is given when ordering, mouldings, seals and rails must be adapted on site. Costs of adjustment and installation work are not accepted by Artweger.













# SPARE PARTS

ARTWEGER price list 03/2023. For specialised trade outlets only.  
Suggested retail prices in EUR not including VAT. DIMENSIONS IN MILLIMETRES.

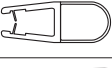
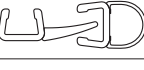
Art. no.

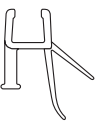

Base price

Artweger MOVE		Pieces	Art. no.	Base price
	<b>Magnetic seal, set 1 - 180°</b> Quadruple sliding door - Art. no.: MGD0.., MRD0..	2	<b>MZ201</b>	78
	<b>Magnetic seal, set 2 - 90°</b> Double sliding door next to side screen - Art. no.: MG2.., MR2..	1+1	<b>MZ202</b>	73
	<b>Magnetic seal, set 3 - 90°</b> Corner entry - Art. no.: MGE0.., MRE0..	1+1	<b>MZ203</b>	73
	<b>fixed-part seal, set 1 vertical</b> Double sliding door - Art. no.: MG2.., MG3.., MG5.., MGF.., MGK.., MR2.., MR3.., MR5.., MRF.., MRK	2	<b>MZ204</b>	64
	<b>fixed-part seal, set 2 vertical</b> Quadruple sliding door, corner entry - Art. no.: MGD0.., MGE0.., MRD0.., MRE0..	2	<b>MZ205</b>	78
	<b>Door stop seal set 1 vertical</b> Double sliding door - Art. no.: MG5.., MGV..	1	<b>MZ206</b>	64
	<b>Door stop seal set 2 vertical</b> Double sliding door - Art. no.: MR5.., MRV..	1	<b>MZ207</b>	64
	<b>Door stop seal set 3 vertical</b> Double sliding door - Art. no.: MGV.., MRV..	1+1	<b>MZ208</b>	69
	<b>Wall connection seal</b> Double sliding door, quadruple sliding door, corner entry - Art. no.: MG2.., MG3.., MG5.., MGD0.., MGE0.., MGF.., MGK..	2	<b>MZ209</b>	64
	<b>Lower door seal set 1 horizontal</b> Sliding door, double sliding door - Art. no.: MGV.., MG2.., MG3.., MG5.., MRV.., MR2.., MR3.., MR5..	1	<b>MZ210</b>	52
	<b>Lower door seal set 2 horizontal</b> Quadruple sliding door - Art. no.: MGD0.., MRD0..	2	<b>MZ211</b>	57
	<b>Lower door seal set 3 horizontal</b> Corner entry - Art. no.: MGE0.., MRE0..	2	<b>MZ212</b>	64
	<b>Unhooking guard profile</b> Sliding door, double sliding door, quadruple sliding door, corner entry - Art. no.: MG2.., MG3.., MG5.., MGD0.., MGE0.., MGF.., MGK.., MGV.., MR2.., MR3.., MR5.., MRD0.., MRE0.., MRF.., MRK.., MRV..	2	<b>MZ213</b>	57
	<b>Roller support</b> Sliding door, double sliding door, quadruple sliding door, corner entry - Art. no.: MG2.., MG3.., MG5.., MGD0.., MGE0.., MGF.., MGK.., MGV.., MR2.., MR3.., MR5.., MRD0.., MRE0.., MRF.., MRK.., MRV..	2	<b>MZ103</b>	52

## IMPORTANT

- All prices subject to shipping charge.
- Further individual parts on request.
- When ordering mouldings and seals please specify length. Information on the existing Artweger product is required.











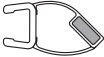
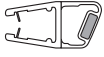

# SPARE PARTS

ARTWEGER price list 03/2023. For specialised trade outlets only.  
Suggested retail prices in EUR not including VAT. DIMENSIONS IN MILLIMETRES.

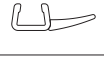
Art. no.



Base price

LIFELINE		Pieces	Art. no.	Base price
	<b>Magnetic seal, set 1</b> 1/4-round shower, pentagonal shower, pivot door, quadruple sliding door - Art. no.: LR., LF., L6., LBD..	2	<b>LZ2 01</b>	76
	<b>Magnetic seal, set 2</b> Double corner entry, triple corner entry - Art. no.: L5., LB5., L3., LB3..	1 × left 1 × right	<b>LZ2 02</b>	76
	<b>Magnetic seal, set 3</b> Pentagonal shower - Art. no.: L7..	1 × left 1 × right	<b>LZ2 12</b>	110
	<b>Magnetic seal, set 4</b> 1/4-round shower - Art. no.: L8..	2	<b>LZ2 13</b>	76
	<b>fixed-part seal, set 1 vertical</b> 1/4-round shower, pentagonal shower, double corner entry, triple corner entry, triple sliding door, double sliding door - Art. no.: LR., LF., L5., L3., L9., L2..	2	<b>LZ2 03</b>	44
	<b>Door seal, vertical</b> 1/4-round shower, double corner entry, triple corner entry, triple sliding door, double sliding door, quadruple sliding door - Art. no.: LR., L5., LB5., L3., LB3., L9., LB9., L2., LB2., LBD.	2	<b>LZ2 04</b>	44
	<b>Sealing strip, set, middle part, vertical</b> Triple corner entry, triple sliding door - Art. no.: L3., L9..	2	<b>LZ2 05</b>	44
	<b>Sealing strip, set folding door (door part)</b> Folding door - Art. no.: L4..	1+2	<b>LZ2 07</b>	69
	<b>Sealing strip, set folding door (fixed part)</b> Folding door - Art. no.: L4..	2	<b>LZ2 08</b>	49
	<b>Sealing strip, set vertical</b> Pentagonal shower - Art. no.: LF..	2	<b>LZ2 09</b>	59
	<b>Sealing strip, fixed part, vertical</b> 1/4-round shower, pivot door - Art. no.: L8., L6..	1	<b>LZ2 10</b>	38
	<b>Strip seal, horizontal</b> 1/4-round shower, pivot door - Art. no.: L8., L6..	1	<b>LZ2 11</b>	34
	<b>Closure strip, set, vertical</b> Triple sliding door, double sliding door - Art. no.: L9., LB9., L2., LB2..	1	<b>LZ2 06</b>	42
	<b>Roller support, set 1</b> 1/4-round shower - Art. no.: LR..	2 × left 2 × right	<b>LZ1 01</b>	62
	<b>Roller support, set 2</b> Double corner entry, double sliding door - Art. no.: L5., L2..	2 × left 2 × right	<b>LZ1 02</b>	60

## IMPORTANT

- A clear product identification is given by means of Artweger guarantee number (see guarantee certificate or sticker on the product) or article number (including all codes). Alternatively an indication of the Artweger delivery note number or invoice number is possible. If no clear product identification is given when ordering, mouldings, seals and rails must be adapted on site. Costs of adjustment and installation work are not accepted by Artweger.











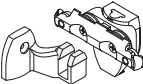

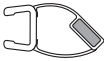

# SPARE PARTS

ARTWEGER price list 03/2023. For specialised trade outlets only.  
Suggested retail prices in EUR not including VAT. DIMENSIONS IN MILLIMETRES.

Art. no.

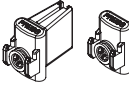

Base price

LIFELINE		Pieces	Art. no.	Base price
	<b>Roller support, set 3</b>	3 × left	<b>LZ1 03</b>	94
	Triple corner entry, triple sliding door - Art. no.: L3.., L9..	3 × right		
	<b>Roller support, set 4</b>	2 × left	<b>LZ1 04</b>	42
	Folding door - Art. no.: L4..	2 × right		
	<b>Roller support, set 5</b>	1 × left	<b>LZ1 05</b>	65
	Pentagonal shower - Art. no.: LF..	1 × right		
	<b>Roller support, set MOBIL 1</b>	3	<b>LZ1 16</b>	69
	Double sliding door, double corner entry - Art. no.: LB2..			
	<b>Roller support, set MOBIL 2</b>	5	<b>LZ1 17</b>	103
	Triple sliding door, triple corner entry - Art. no.: LB9.., LB3..			
	<b>Roller support, set MOBIL 3</b>	6	<b>LZ1 18</b>	118
	Quadruple sliding door - Art. no.: LBD			
SLIDE		Pieces	Art. no.	Base price
	<b>Magnetic seal, set</b>	2	<b>VSZ2 01</b>	41
	1/4-round shower - Art. no.: VSR..			
	<b>Magnetic seal, set</b>	2	<b>VSZ2 02</b>	41
	Corner entry - Art. no.: VSE..			
	<b>Sealing set fixed part</b>	2	<b>VSZ2 03</b>	41
	1/4-round shower, corner entry - Art. no.: VSR.., VSE..			
	<b>Sealing set door part</b>	2	<b>VSZ2 04</b>	41
1/4-round shower, corner entry - Art. no.: VSR.., VSE..				
	<b>Roller support, set</b>	2+1+1	<b>VSZ1 01</b>	75
	1/4-round shower, corner entry - Art. no.: VSR.., VSE..			
BASELINE		Pieces	Art. no.	Base price
	<b>Magnetic seal, set</b>	2	<b>GZ2 02</b>	52
	1/4-round shower starting from 2013 - Art. no.: GR..			
	<b>Magnetic seal, set</b>	2	<b>GZ2 03</b>	52
	Corner entry, swinging door - Art. no.: GE.., G2..			
	1/4-round shower up to 12/2012 - Art. no.: GR..			
	<b>Sealing set, vertical</b>	2	<b>GZ2 01</b>	44
	1/4-round shower - Art. no.: GR..			
	<b>Roller support, set 1</b>	8	<b>GZ1 01</b>	48
	1/4-round shower - Art. no.: GR..			
	1/4-round shower starting with 2007 - Art. no.: GR..	8	<b>GZ1 07</b>	50
	<b>Roller support, set 2</b>	8	<b>GZ1 02</b>	42
	Corner entry - Art. no.: GE..			
	Corner entry starting with 2007 - Art. no.: GE..	8	<b>GZ1 08</b>	42
	<b>Roller support, set 3</b>	8	<b>GZ1 03</b>	41
	Triple sliding door - Art. no.: G9..			
	Triple sliding door starting with 2007 - Art. no.: G9..		<b>GZ1 09</b>	50
	<b>Door bearing, set</b>	2 × left	<b>GZ1 04</b>	11
	Swinging door - Art. no.: G2..	2 × right		

## IMPORTANT

- All prices subject to shipping charge.
- Further individual parts on request.
- When ordering mouldings and seals please specify length. Information on the existing Artweger product is required.

# SPARE PARTS

ARTWEGER price list 03/2023. For specialised trade outlets only.  
Suggested retail prices in EUR not including VAT. DIMENSIONS IN MILLIMETRES.

Art. no.



Base price

ARTWEGER 360 Tub folding screens		Pieces			
	<b>Drip mouldings, set 1 horizontal</b> Single folding screen with fixed part - Art. no.: 9TKP..	1	<b>9Z5 01</b>	34	
	<b>Drip mouldings, set 15 horizontal</b> Single folding screen left - Art. no.: 9TKK11.., 9TKK13..	1	<b>9Z5 15</b>	34	
	<b>Drip mouldings, set 16 horizontal</b> Single folding screen right - Art. no.: 9TKK21.., 9TKK23..	1	<b>9Z5 16</b>	34	
	<b>Drip mouldings, set 17 horizontal</b> Double folding screen left - Art. no.: 9TKK15..	1+1	<b>9Z5 17</b>	54	
	<b>Drip mouldings, set 18 horizontal</b> Double folding screen right - Art. no.: 9TKK25..	1+1	<b>9Z5 18</b>	54	
	<b>Drip mouldings, set 19 horizontal</b> Triple folding screen left - Art. no.: 9TKK17..	1+1+1	<b>9Z5 19</b>	76	
	<b>Drip mouldings, set 20 horizontal</b> Triple folding screen right - Art. no.: 9TKK27..	1+1+1	<b>9Z5 20</b>	76	
		<b>Drip mouldings, set 22</b> Single folding screen with fixed part - Art. no.: 9TKP.	1	<b>9Z5 22</b>	34
		<b>Bellows seal set 14 vertical</b> Single folding screen - Art. no.: 9TKP.	1+1+2	<b>9Z2 24</b>	96
		<b>Bellows seal set 17 vertical</b> Double folding screen - Art. no.: 9TKK15.., 9TKK25..	1+1+2	<b>9Z2 31</b>	90
	<b>Bellows seal set 18 vertical</b> Triple folding screen - Art. no.: 9TKK17.., 9TKK27..	1+1+2+1	<b>9Z2 32</b>	115	
BASELINE Tub folding screens		Pieces			
	<b>Strip seal, set, horizontal</b>				
	Single folding screen 700 - Art. no.: GK12	1	<b>GZ4 01</b>	46	
	Single folding screen 750 - Art. no.: GK32	1	<b>GZ4 02</b>	46	
	Double folding screen - Art. no.: GK42	2	<b>GZ4 03</b>	50	
	Triple folding screen - Art. no.: GK72	3	<b>GZ4 04</b>	59	

## IMPORTANT

- A clear product identification is given by means of Artweger guarantee number (see guarantee certificate or sticker on the product) or article number (including all codes). Alternatively an indication of the Artweger delivery note number or invoice number is possible. If no clear product identification is given when ordering, mouldings, seals and rails must be adapted on site. Costs of adjustment and installation work are not accepted by Artweger.



# SPARE PARTS

ARTWEGER price list 03/2023. For specialised trade outlets only.  
Suggested retail prices in EUR not including VAT. DIMENSIONS IN MILLIMETRES.

Art. no.

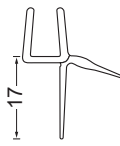
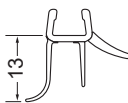
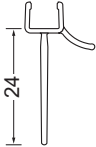

Base price

BODY+SOUL		Pieces		
	<b>Magnetic seal, set 1</b> 1/4-round shower, winged door in alcove - Art. no.: 7F4., 7F8., 7H4., 7H8.	2	<b>7Z4 01</b>	62
	<b>Magnetic seal, set 2</b> Winged door with side screen, corner entry - Art. no.: 7F9., 7FE., 7H9., 7HE.	1 × left 1 × right	<b>7Z4 02</b>	62
	<b>Magnetic seal, set 3</b> 1/4-round shower, winged door in alcove - Art. no.: 7P4., 7P5., 7P8., 7R4., 7R5., 7R8.	2	<b>7Z4 13</b>	62
	<b>Magnetic seal, set 4</b> Winged door with side screen - Art. no.: 7P9., 7R9.	1 × left 1 × right	<b>7Z4 14</b>	62
	<b>Magnetic seal, set 5</b> Corner entry - Art. no.: 7PE., 7RE.	1 × left 1 × right	<b>7Z4 15</b>	62
	<b>fixed-part seal, set 1 vertical</b> 1/4-round shower, winged door in alcove, winged door with side screen - Art. no.: 7F4., 7F8., 7F9., 7H4., 7H8., 7H9., 7P4., 7P5., 7P7., 7P8., 7P9., 7R4., 7R5., 7R8., 7R9.	1	<b>7Z4 03</b>	47
	<b>fixed-part seal, set 2 vertical</b> Corner entry - Art. no.: 7HE., 7FE., 7PE., 7RE	2	<b>7Z4 04</b>	54
	<b>Roof element seal set 1</b> 1/4-round shower, winged door in alcove, winged door with side screen Art. no.: 7F4., 7F8., 7F9., 7H4., 7H8., 7H9., 7P4., 7P5., 7P7., 7P8., 7P9., 7R4., 7R5., 7R8., 7R9.	2	<b>7Z4 07</b>	23
	<b>Roof element seal set 2</b> Corner entry - Art. no.: 7FE., 7HE., 7PE., 7RE.	4	<b>7Z4 08</b>	49
	<b>Drip mouldings, set 1 horizontal</b> 1/4-round shower, winged door in alcove, winged door with side screen - Art. no.: 7F4., 7F8., 7F9., 7H4., 7H8., 7H9.	1	<b>7Z4 05</b>	23
	<b>Drip mouldings, set 2 horizontal</b> Corner entry - Art. no.: 7FE., 7HE.	2	<b>7Z4 06</b>	38
	<b>Drip mouldings, set 1 horizontal</b> 1/4-round shower, winged door in alcove, winged door with side screen - Art. no.: 7P4., 7P5., 7P7., 7P8., 7P9., 7R4., 7R5., 7R8., 7R9.	1	<b>7Z4 09</b>	34
	<b>Drip mouldings, set 3 horizontal</b> Corner entry - Art. no.: 7PE., 7RE.	2	<b>7Z4 11</b>	54
	<b>Drip mouldings, set 2 horizontal</b> 1/4-round shower, winged door in alcove, winged door with side screen - Art. no.: 7P4., 7P5., 7P7., 7P8., 7P9., 7R4., 7R5., 7R8., 7R9.	1	<b>7Z4 10</b>	34
	<b>Drip mouldings, set 4 horizontal</b> Corner entry - Art. no.: 7PE., 7RE.	2	<b>7Z4 12</b>	54

## IMPORTANT

- All prices subject to shipping charge.
- Further individual parts on request.
- When ordering mouldings and seals please specify length. Information on the existing Artweger product is required.



# SPARE PARTS

ARTWEGER price list 03/2023. For specialised trade outlets only.  
Suggested retail prices in EUR not including VAT. DIMENSIONS IN MILLIMETRES.

Art. no.

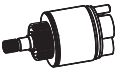

Base price

ARTSHOWER		Pieces		
	Thermostat cartridge	1	<b>VAZ1 01</b>	139
	Flow control cartridge	1	<b>VAZ1 02</b>	59
	Shower holder	1	<b>VAZ1 03</b>	49

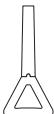
ACCESSORIES		Pieces		
	Replacement lip for squeegee			
		Width 240 mm	1	<b>OZ1 17</b> 15
		Width 360 mm	1	<b>OZ1 18</b> 17

## IMPORTANT

- A clear product identification is given by means of Artweger guarantee number (see guarantee certificate or sticker on the product) or article number (including all codes). Alternatively an indication of the Artweger delivery note number or invoice number is possible. If no clear product identification is given when ordering, mouldings, seals and rails must be adapted on site. Costs of adjustment and installation work are not accepted by Artweger.









## SINGLE-PANE SAFETY GLASS (ESG)



**EK**  
Glass clear



**SA**  
Satin



**RW**  
Strip Satin



**C**  
ARTCLEAR GLAZING  
GLASS FINISHING (ESG)

State height position H when ordering. The height position always refers to the bottom of the Satin strip.

## SYNTHETIC GLAZING

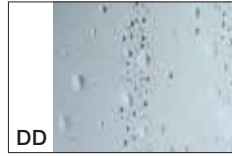

**DD**  
Diamond

## ARTWALL 3.0 for ARTWALL 3.0, TWINLINE 1, TWINLINE 2 and ARTLIFT



**WM**  
White

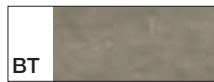

**BT**  
Concrete



**RS**  
Rust



**CY**  
Canyon



**SC**  
Slate

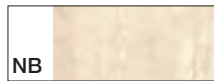

**NB**  
Stone beige



**NG**  
Grey stone

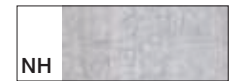

**NH**  
Light stone colour

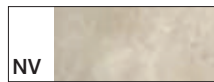

**NV**  
Stone Verdello

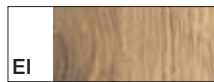

**EI**  
Oak

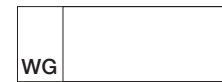

**WG**  
Glossy white

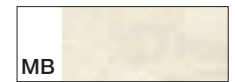

**MB**  
Beige glossy marble



**MG**  
Grey glossy marble



**F1**  
Matterhorn



**F2**  
Forest



**F3**  
Beach



**ML**  
Light glossy marble

Photo motifs only for ARTWALL 3.0 TREND wall panels 2550 × 1000 mm.

## BODY+SOUL



**AT**  
Anthracite/silver

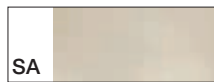

**SA**  
Sand/silver



**BD**  
Bordeaux/silver

Plastic

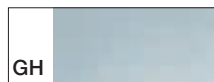

**GH**  
Glass clear/Silver



**GT**  
Glass anthracite/silver



**GB**  
Glass Bordeaux/silver

glass

## TWINLINE 1, TWINLINE 2, ARTLIFT glass for skirts

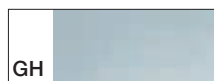

**GH**  
Glass clear



**AT**  
Glass Anthracite



**BD**  
Glass Bordeaux

glass

**Artweger GmbH. & Co. KG**

Sulzbacherstraße 60 | 4820 Bad Ischl | Austria

Tel. +43 6132 205-20 | Fax +43 6132 205-5003

info@artweger.com | www.artweger.com



Via your Artweger  
Guarantee Partner.